

# Storm Water Pollution Prevention Plan for:

Cajun Express Carwash  
2235 U.S. 90  
Gautier, Mississippi

## Contractor:

K. B. Kaufmann & Co., Inc.  
3173 Terrace Ave. E.  
Slidell, LA 70458

## SWPPP Prepared By:

Dammon Engineering, Inc.  
554 Old Spanish Trail  
Slidell, LA 70458



## SWPPP Preparation Date:

12/17/2020

### *Estimated Project Dates:*

**Project Start Date:** 01/01/2021  
**Project Completion Date:** 06/31/2021

Contact Information

Section 1: Site Evaluation, Assessment, and Planning

Section 2: Construction Best Management Practices (BMPs) and Controls

Section 3: Good Housekeeping BMPs

Section 4: Maintenance

Mississippi Department of Environmental Quality (MDEQ) Specifications

## CONTACT INFORMATION

Property Owner Contact	Contact	Address
Troy Lirette	228-861-3940 Troy_Lirette@yahoo.com	13924 Deneen Road Ocean Springs 39565
Project Contractor		
Gary Sleaf	Office : (985) 649-7381 Gary@kbkaufmann.com	3173 Terrace Ave. E. Slidell, La. 70458

## **Section 1: Site Evaluation, Assessment, and Planning**

Construction Activity: Construction for this project includes grading, fire main relocation, storm sewer installation for an expansion at the existing plant and sanitary sewer lift station with forcemain. The sanitary sewer forcemain will be bored from new construction to the existing forcemain, approximate 1000 ft of new forcemain. No additional domestic water services are required for this project.

Disturbance: The anticipated disturbance for this project is 2.735 acres

Existing Soils: The existing soils for this project consist of silty clays. These soils are moderately erodible given the gentle slopes of the existing and proposed grades of the project.

Existing Topography: The existing slopes are generally less than five percent except for the side slopes on drainage swale(s).

Receiving Waters: The drainage from the site area where disturbance is planned, post development is less than pre development for this site, thus requiring no measures for mitigation of the quality of storm water.

Potential Sources of Pollution: Sources of pollution include sediment from construction operations and pollutants related to building construction such as concrete and mortar.

## **Section 2: Construction Best Management Practices (BMPs) and Controls**

### Construction Phasing:

- A. Strip and stockpile topsoil.
- B. Construct the temporary sediment basin and direct storm water to it with grading operations as soon as practicable.
- C. Install storm sewer in conjunction with grading operations.
- D. Install permanent outlet protection for all storm sewer once it is installed except for the areas located inside of the sediment basin. As shown on sheet C104.
- E. Finalize grading operations.
- F. Spread topsoil and place permanent seeding on areas that will not be disturbed by building construction.
- G. Finalize building construction.
- H. Place topsoil.
- I. Finalize permanent stabilization.
- J. Remove temporary BMPs.

### Site Preparation BMPs:

- A. Construction Exit Pad- MDEQ specification attached.
- B. Topsoiling- MDEQ specification attached.

### Surface Stabilization BMPs:

- A. Dust Control- MDEQ specification attached.
- B. Housekeeping Practices- MDEQ specification attached.
- C. Mulching- MDEQ specification attached.
- D. Permanent Seeding- MDEQ specification attached.
- E. Temporary Seeding- MDEQ specification attached.

### Runoff Conveyance BMPs:

- A. Check Dam- MDEQ specification attached.
- B. Outlet Protection- MDEQ specification attached.

Sediment Control BMPs:

- A. Brush Fabric Barrier- MDEQ specification attached.
- B. Sediment Barrier (Silt Fence)- MDEQ specification attached.
- C. Sediment Basin- MDEQ specification attached.

### Section 3: Good Housekeeping BMPs

Material Handling and Waste Management:

- A. Construction equipment, tools, etc. should be stored in a central location when not in use.
- B. Garbage and other waste materials should be properly disposed.
- C. A wash out facility shall be installed at least 50 feet upstream of any stormdrains.
- D. All sanitary facilities shall be installed at least 50 feet upstream of any stormdrains.
- E. An area for equipment and vehicle fueling and maintenance shall be located on the site at least 50 feet upstream of any storm drains.
- F. All fuel tanks shall be double walled or placed inside a berm lined with an impervious layer with at least 110% containment. See detail on sheet ED-1.
- G. See the attached MDEQ specification for housekeeping for further information regarding these items.

### Section 4: Maintenance

- A. Site Preparation BMPs: Inspect these items weekly at a minimum and following each 1/2" rain event in 24 hours. Below are more specific maintenance requirements
  - 1 *Construction Exit Pad:* Inspect daily for large chunks of soil. Inspect following heavy use and after each storm event.
  - 2 *Topsoil:* Inspect until vegetation is established.
- B. Surface stabilization BMPs: Inspect these items weekly at a minimum and following each 1/2" rain event in 24 hours. Below are more specific maintenance requirements:
  - 1 *Dust Control:* Inspect construction site during vehicular traffic or windy conditions until the site is stabilized.
  - 2 *Housekeeping Practices:* Inspect once per week and following each 1/2" rain event in 24 hours. See specifications and sheets EC-1, EC-2, and EC-3 for further maintenance for individual BMPs.
  - 3 *Mulching:* Inspect weekly and following each rain event. Continue inspections until vegetation is well established.
  - 4 *Permanent Seeding:* Inspect weekly until vegetative cover is established. Generally, vegetation is not determined to be fully established until it has been maintained for one year.
  - 5 *Temporary Seeding:* Inspect for erosion weekly until established. After establishment, inspect monthly.
- C. Runoff Conveyance BMPs: Inspect these items weekly at a minimum and following each 1/2" rain event in 24 hours. Below are more specific maintenance requirements:

- 1 *Check Dam*: Inspect for rock displacement and abutments following each storm event.
  - 2 *Outlet Protection*: Inspect following heavy rain events to see if stones have become dislodged. If so, replace with a larger size stone.
- D. *Sediment Control BMPs*: Inspect these items weekly at a minimum and following each ½" rain event. Below are more specific maintenance requirements:
- 1 *Brush/Fabric Barrier*: Inspect weekly and remove sediment once it reaches half the depth of the original fabric height.
  - 2 *Sediment Barrier (Silt Fence)*: Inspect weekly for anchorage and tears. Remove sediment and replace the fabric once sediment has reached half the height of the fence.
  - 3 *Sediment Pond*: Inspect the depth of sediment monthly. Remove sediment once it reaches half the basin volume.
- E. *Specifications*: See the attached MSDEQ specifications for additional maintenance of all BMPs.

Insert EC-1 & EC-2

Insert Volume 1 page 4-6 thru 4-11

Insert Volume 1 page 4-20 – 4-24

Insert Volume 1 page 4-29 - 4-32

Insert Volume 1 page 4-43 - 4-52

Insert Volume 1 page 4-53 - **4-63**

Insert Volume 1 page 4-103 - 4-109

Insert Volume 1 page 4-117 - 4-130

Insert Volume 1 page 4-199 - 4-209

Insert Volume 1 page 4-255 - 4-260

Insert Volume 1 – 4-284 - 4-321

## Construction-Exit Pad (CEP)



### Practice Description

A construction-exit pad is a stone-base pad designed to provide a buffer area where mud- and caked-soil can be removed from the tires of construction vehicles to avoid transporting it onto public roads. This practice applies anywhere traffic will be leaving a construction site and moving directly onto a public road or street.

### Planning Considerations

Roads and streets adjacent to construction sites should be kept clean for the general safety and welfare of the public. A construction-exit pad (Figure CEP-1) should be provided where mud can be removed from construction vehicle tires before they enter a public road.

If the action of the vehicle traveling over the gravel pad does not sufficiently remove the mud, or if the site is in a particularly sensitive area, a washing facility should be included with the pad (Figure CEP-2). When a washing facility is required, all wash water shall be diverted into a sediment trap or basin.

If the construction-exit pad is located in an area with soils that will not support traffic when wet, a geotextile liner located beneath the aggregate will be required to provide stability to the pad.

Construction of stabilized roads throughout the development site should be considered to lessen the amount of mud transported by vehicular traffic. The construction-exit pad

should be located to provide for maximum use by construction vehicles. Consideration should be given to limiting construction vehicles to only one ingress and egress point. Measures may be necessary to make existing traffic use the construction-exit pad.

## Design Criteria and Construction

### Site Preparation

Remove all vegetation and other unsuitable material from the foundation area.

### Grading

Grade and crown the area for positive drainage. Utilize a diversion to direct any surface flow away from the construction-exit pad. Any runoff from the pad should be diverted into a sediment trap or basin. Install a pipe under the pad, if needed, to maintain drainage ditches along public roads.

### Aggregate Size

Aggregate should be Mississippi Department of Transportation Size 1 Stabilizer. Aggregate surface shall be left smooth and sloped for drainage.

### Pad Dimensions

The exit pad shall have a minimum aggregate thickness of 6". The exit pad must be a minimum of 50 feet long and shall provide for entering and parking the longest construction vehicles anticipated. MDOT Drawing ECD-15 provides an example of a stabilized construction entrance. The exit pad shall have a typical width of 20 feet, but may be narrower or wider to equal the full width of the vehicular egress.

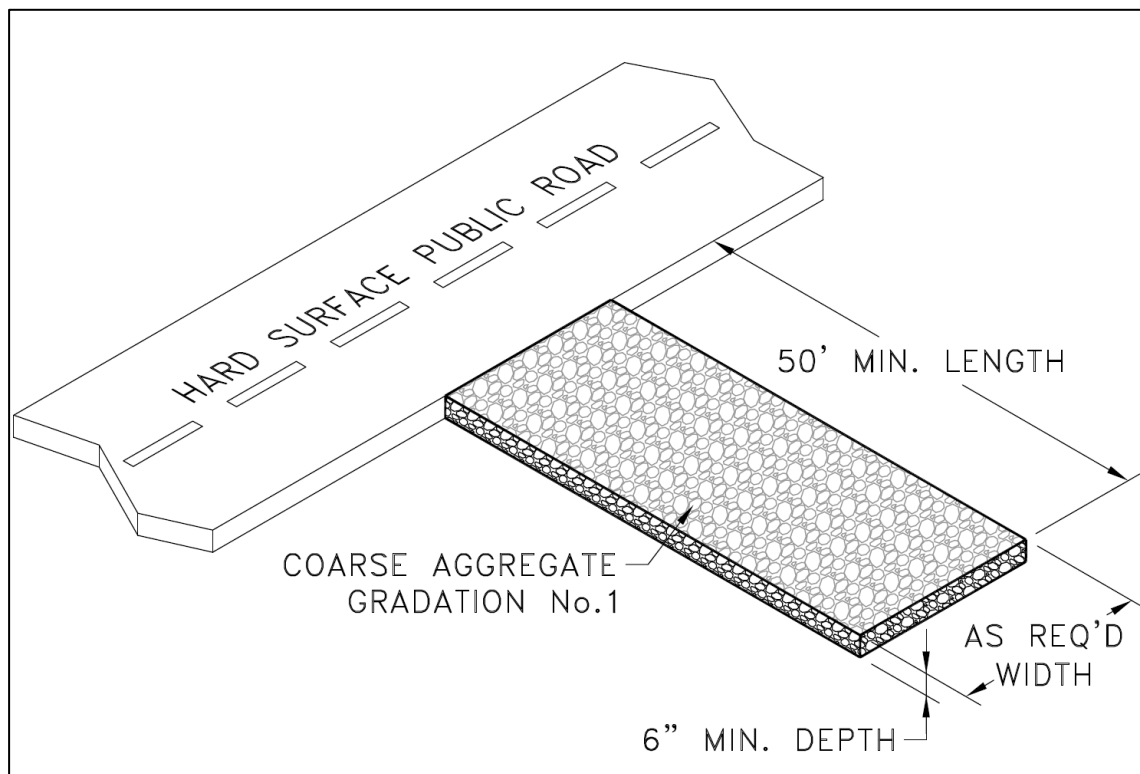

Figure CEP-1 Gravel Construction Exit

## Geotextiles

A non-woven geotextile meeting the requirements shown in the table below for Class IV geotextiles should be used under the rock when the subgrade is soft or the blow count is less than 10.

Table CEP-1 Requirements for Nonwoven Geotextile

Property	Test method	Class I	Class II	Class III	Class IV <sup>1</sup>
Tensile strength (lb) <sup>2</sup>	ASTMD 4632 grab test	180 minimum	120 minimum	90 minimum	115 minimum
Elongation at failure (%) <sup>2</sup>	ASTMD 4632	≥ 50	≥ 50	≥ 50	≥ 50
Puncture (pounds)	ASTMD 4833	80 minimum	60 minimum	40 minimum	40 minimum
Ultraviolet light (% residual tensile strength)	ASTMD 4355 150-hr exposure	70 minimum	70 minimum	70 minimum	70 minimum
Apparent opening size (AOS)	ASTMD 4751	As specified max. #40 <sup>3</sup>	As specified max. #40 <sup>3</sup>	As specified max. #40 <sup>3</sup>	As specified max. #40 <sup>3</sup>
Permittivity sec <sup>-1</sup>	ASTMD 4491	0.70 minimum	0.70 minimum	0.70 minimum	0.10 minimum

Table copied from NRCS Material Specification 592.

<sup>1</sup> Heat-bonded or resin-bonded geotextile may be used for classes III and IV. They are particularly well suited to class IV. Needle-punched geotextile required for all other classes.

<sup>2</sup> Minimum average roll value (weakest principal direction).

<sup>3</sup> U.S. standard sieve size.

## Washing

A washing facility shall be provided, if necessary, to prevent mud- and caked-soil from being transported to public streets and highways. It shall be constructed of concrete, stone, and/or other durable materials. Provisions shall be provided for the mud and other material to be carried away from the washing facility into a sediment trap or basin to allow for settlement of the sediment from the runoff before it is released from the site.

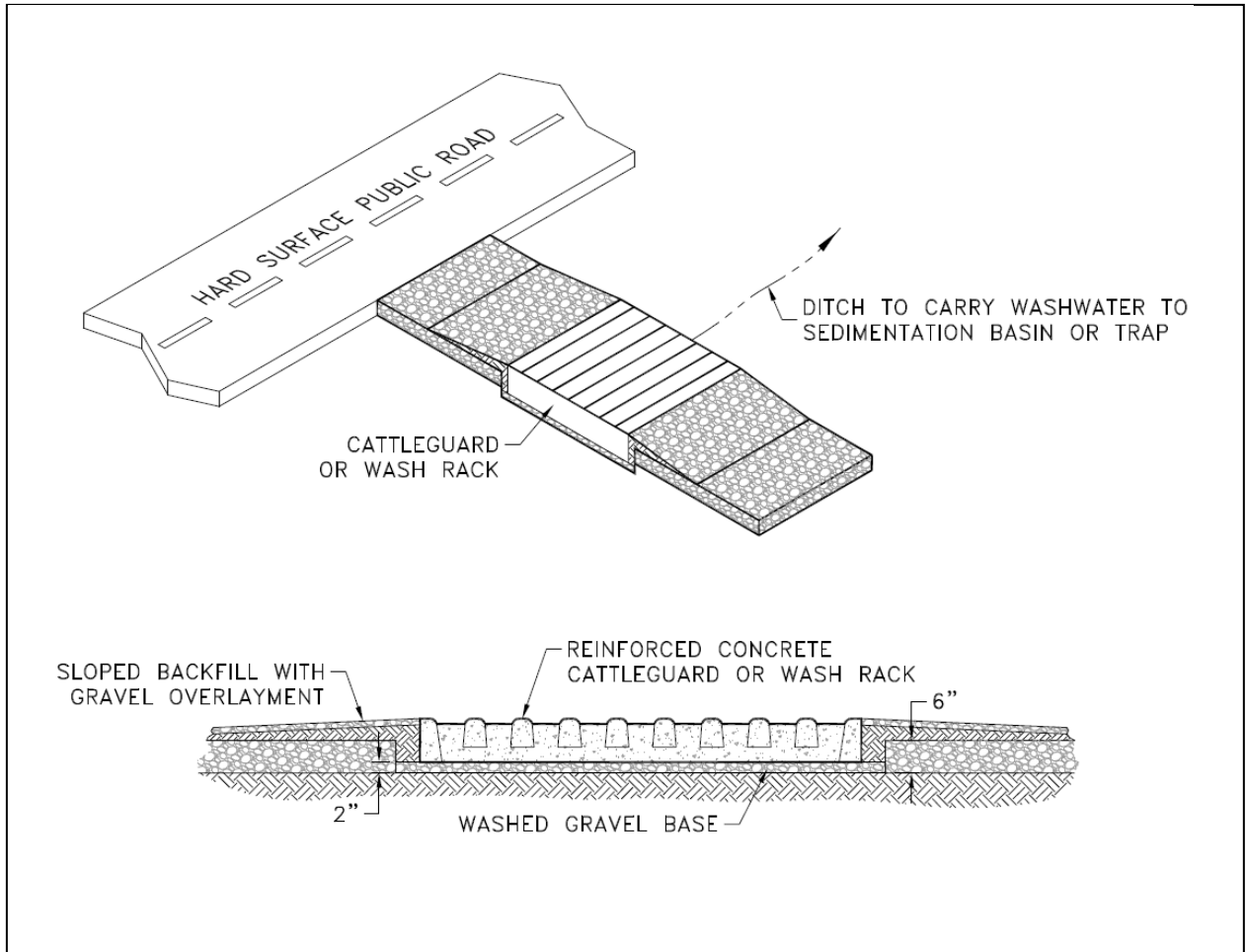

Figure CEP-2 Construction Exit with Wash Rack

## Common Problems

*Consult with a qualified design professional if any of the following occur:*

Inadequate runoff control and sediment washes onto public road: install diversions or other runoff-control measures.

Ruts and muddy conditions develop as stone are pressed into soil: increase stone size or pad thickness, or add geotextile fabric.

Pad too short for heavy-construction traffic: consult design professional about extending pad to the necessary length

## Maintenance

Remove large chunks of mud- or caked-soil from construction-exit pad daily to minimize sediment buildup.

Inspect stone pad and sediment-disposal area weekly and after storm events or heavy use.

Reshape pad as needed for drainage and runoff control.

Top-dress with clean-specified stone as needed to maintain effectiveness of the practice.

Immediately remove mud or sediment tracked or washed onto public road.

Repair any broken-road pavement immediately.

Remove unneeded exit-pad materials from areas where permanent vegetation will be established.

## References

### BMPs from Volume 1

#### Chapter 4

Construction Phasing/Sequencing (CPS)	4-3
Land Grading (LG)	4-16
Housekeeping (HK)	4-43
Preservation of Vegetation (PV)	4-64

#### MDOT Drawings Referenced

ECD-15 Stabilized Construction Entrance	4-11
---	------

STATE	PROJECT NO.
MISS.	

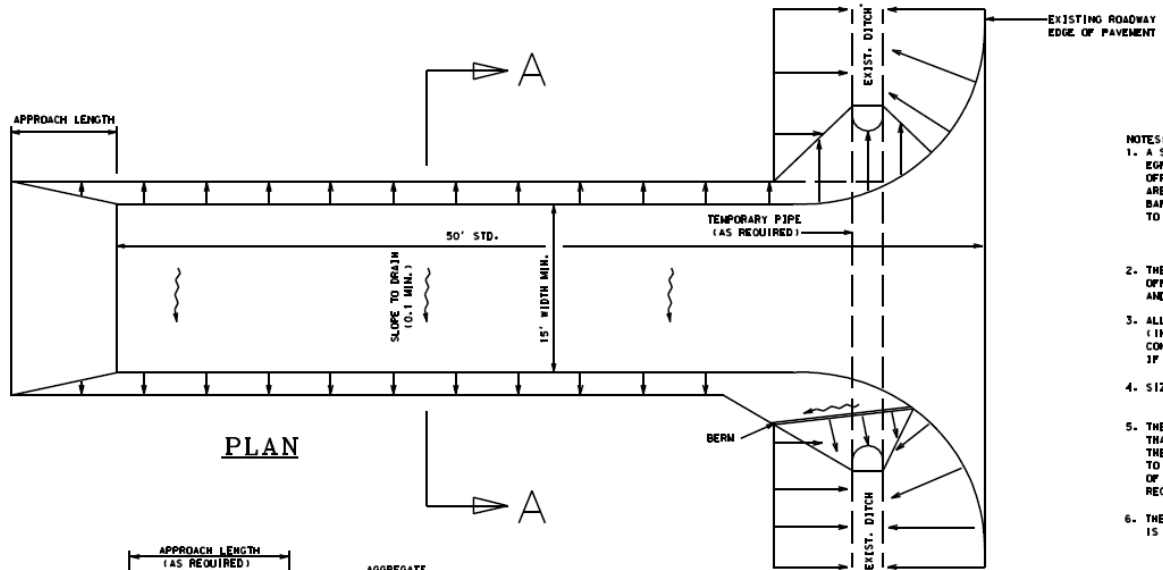

- NOTES:
1. A STABILIZED CONSTRUCTION ENTRANCE SHALL BE CONSTRUCTED AT POINTS OF EGRESS FROM UNSTABILIZED AREAS OF THE PROJECT TO PUBLIC ROADS WHERE OFFSITE TRACKING OF MUD COULD OCCUR. TRAFFIC FROM UNSTABILIZED AREAS OF THE PROJECT SHALL BE DIRECTED THRU THE STABILIZED ENTRANCE. BARRIERS, FLAGGING, OR OTHER POSITIVE MEANS SHALL BE USED AS REQUIRED TO LIMIT AND DIRECT VEHICULAR EGRESS ACROSS THE STABILIZED ENTRANCE.
  2. THE CONTRACTOR MAY PROPOSE AN ALTERNATIVE TECHNIQUE TO MINIMIZE OFFSITE TRACKING OF SEDIMENT. THE ALTERNATIVE MUST BE REVIEWED AND APPROVED BY THE ENGINEER PRIOR TO ITS USE.
  3. ALL MATERIALS SPILLED, DROPPED, OR TRACKED ONTO PUBLIC ROADS (INCLUDING THE STABILIZED CONSTRUCTION ENTRANCE AGGREGATE AND CONSTRUCTION MUD) SHALL BE REMOVED DAILY, OR MORE FREQUENTLY IF SO DIRECTED BY THE ENGINEER.
  4. SIZE 1 STABILIZER AGGREGATE SHALL BE USED
  5. THE STABILIZED CONSTRUCTION ENTRANCE SHALL BE MAINTAINED IN A CONDITION THAT WILL ALLOW IT TO PERFORM IT'S FUNCTION TO PREVENT OFFSITE TRACKING. THE STABILIZED CONSTRUCTION ENTRANCE SHALL BE RINSED WHEN NECESSARY TO MOVE ACCUMULATED MUD DOWNWARD THRU THE STONE. ADDITIONAL STABILIZATION OF THE VEHICULAR ROUTE LEADING TO THE STABILIZED ENTRANCE MAY BE REQUIRED TO LIMIT THE MUD TRACKED.
  6. THE NOMINAL SIZE OF A STANDARD STABILIZED CONSTRUCTION ENTRANCE IS 15' X 50' UNLESS OTHERWISE SHOWN IN THE EROSION CONTROL PLAN

PLAN

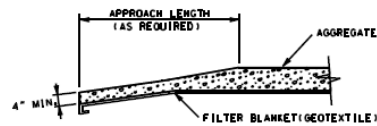

TRANSITION DETAIL

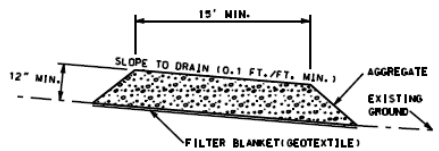

SECTION A-A

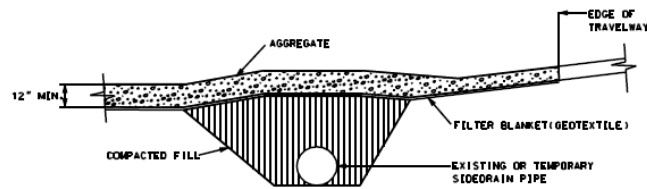

RURAL CONNECTION DETAIL

MISSISSIPPI DEPARTMENT OF TRANSPORTATION	
STABILIZED CONSTRUCTION ENTRANCE	
WORKING NUMBER	ECD-15
SHEET NUMBER	
FILE NAME: EROSION CONTROL ECD-15.DGN	
DESIGN DATE: _____	DATE: _____

## Topsoiling (TSG)



### Practice Description

Topsoiling is the removal of a desirable soil surface, referred to as topsoil, at a site prior to construction and using it on areas to be vegetated. Topsoiling a site usually improves the quality of the plant-growth medium at the site and increases the likelihood of successful plant establishment and performance. This practice applies to sites that are to be disturbed by excavation, compaction or filling, and to other areas where the subsoil is unsuitable for plant growth.

### Planning Considerations

Topsoil is the surface layer of the soil profile, generally characterized as darker than the subsoil due to enrichment with organic matter. It is the major zone of root development and biological activity. Microorganisms that enhance plant growth thrive in this layer. Topsoil can usually be differentiated from subsoil by texture as well as color. Clay content usually increases in the subsoil.

The depth of topsoil may be quite variable. On severely eroded sites it may be non-existent.

Advantages of topsoil include its high organic-matter content, friable consistency (soil aggregates can be crushed with only moderate pressure), its available water-holding capacity, and nutrient content. Most often, it is superior to subsoil in the above characteristics. The texture and friability of topsoil are usually much more conducive to seedling emergence and root growth than subsoils.

In addition to being a better growth medium, topsoil is often less erodible than subsoils, and the coarse texture of topsoil increases infiltration capacity and reduces runoff.

Although topsoil provides an excellent growth medium, there are disadvantages to its use. Stripping, stockpiling, and reapplying topsoil, or importing topsoil, may not always be cost effective. Topsoiling can delay seeding or sodding operations, increasing the exposure time of denuded areas. Most topsoil contains weed seeds, and weeds may compete with desirable species.

In site planning, the option of topsoiling should be compared with that of preparing a seedbed in subsoil. The clay content of subsoils does provide high moisture availability and deter leaching of nutrients. When properly limed and fertilized, subsoils may provide a good growth medium, especially if there is adequate rainfall or irrigation water to allow root development in otherwise high-density material.

Topsoiling is strongly recommended where ornamental plants or high-maintenance turf will be grown. Topsoiling is a recommended procedure when establishing vegetation on shallow soils, soils containing potentially toxic materials, and soils of critically low-pH (high acid) levels.

If topsoiling is to be done, the following items should be considered:

- An adequate volume of topsoil should exist on the site. Topsoil will be spread at a compacted depth of 4" or greater.
- The topsoil stockpile should be located so that it meets specifications and does not interfere with work on the site, block drainage, or release appreciable amounts of sediment.
- Allow sufficient time in scheduling for topsoil to be spread and bonded to the subsoil prior to seeding, sodding, or planting.
- Care must be taken not to apply topsoil to subsoil if the two soils have contrasting textures. Clayey topsoil over sandy subsoil is a particularly poor combination because as water creeps along the junction between the soil layers, sloughing of the topsoil may occur.
- If topsoil and subsoil are not properly bonded, water will not infiltrate into the soil profile evenly and it will be difficult to establish vegetation.

## Design Criteria and Construction

### Materials

Field exploration of the site should be made to determine if there is sufficient surface soil of good quality to justify stripping. Topsoil shall be friable and loamy (loam, sandy loam, silt loam, sandy-clay loam, and clay loam). It shall be free of debris, trash, stumps, rocks, roots, and noxious weeds, and shall give evidence of being able to support healthy vegetation. It shall contain no substance that is potentially toxic to plant growth.

Potential topsoil should be tested by a recognized laboratory. It should meet the following criteria:

- Organic-matter content should be not less than 1.0% by weight.
- The pH range should be from 6.0-7.5. If pH is less than 6.0, lime should be added in accordance with soil-test results or in accordance with the recommendations of the vegetative-establishment practice being used.
- Soluble salts shall not exceed 500 ppm.
- If additional off-site topsoil is needed, it should meet the standards stated above.
- The depth of material meeting the above qualifications should be at least 4". Soil factors such as rock fragments, slope, depth to water table, and layer thickness affect the ease of excavation and spreading of topsoil.

Generally, the upper part of the soil, which is richest in organic matter, is most desirable; however, material excavated from deeper layers may be worth storing if it meets the other criteria listed above.

### **Stripping**

Strip only those areas that will be affected by construction or development. A normal stripping depth is 4-6", but deeper depths may be satisfactory if the soil is suitable and undercutting is allowable in locations such as buildings, water-impoundment structures, roadways, etc. Appropriate sediment-control measures such as sediment barriers, sediment basins, inlet protection, etc., should be in place before the topsoil is stripped. Stripping should not be done on areas intended to support conventional, on-site effluent, disposal lines (field lines).

### **Stockpiling**

The stockpile location should be out of drainageways and traffic routes. Stockpiles should not be placed on steep slopes where undue erosion will take place. Measures should be taken to prevent erosion of the stockpiles. These would include

- Mulching the stockpile when it is left inactive for 14 days or longer.
- Planting temporary vegetation when the stockpile is to be inactive over 30 days.
- Covering the stockpile with plastic whenever the piles are small or any soil loss would damage existing buildings or facilities.
- Planting permanent vegetation when the stockpile use will be inactive over 12 months.
- In cases where the stockpile is small and will be removed in fewer than 14 days, it may be more practical to use a sediment barrier than an erosion-control practice.

### **Site Preparation**

Areas to be covered with topsoil shall be excavated, graded, filled, and shaped to the proper lines, grades, and elevations before topsoil placement is started.

The subgrades should be checked for pH and limed if the pH is less than 6.0. Liming shall be done in accordance with soil tests and in relation to the seeding mixture to be planted. Incorporate lime to a depth of at least 2" by discing.

### Applying Topsoil

Immediately before placement of topsoil, the subsoil should be disced or scarified to a depth of 2" to enhance bonding of the subsoil and topsoil. Topsoil should be uniformly spread to a minimally compacted depth of 4". Required volumes of topsoil may be determined using Table TSG-1.

Table TSG-1 Volume of Soil Needed for Topsoiling

Depth to Spread (inches)	Cubic Yards Per 1,000 Sq. Ft.	Cubic Yards Per Acre
1	3.1	134
2	6.2	268
3	9.3	403
4	12.4	537
5	15.5	672
6	18.6	806

When applying topsoil, maintain needed erosion-control practices such as diversions, grass swales, lined swales, etc. Topsoil should not be spread when it or the subgrade is frozen or muddy.

Precautions should be taken to prevent layering of the topsoil over the subsoil. Mixing and bonding of the two soils should be enhanced by use of discing or cultivation tools.

Settling of the topsoil is necessary to bond the soils together, but undue compaction should be prevented. Light compaction is necessary to increase soil strength, reduce erosion, and enhance vegetation establishment. Excessive compaction should be prohibited as it increases runoff and inhibits seed germination and root development.

Surface irregularities that would impede drainage, increase erosion, or otherwise damage the site should be removed in final grading.

### Common Problems

*Consult with a qualified design professional if any of the following occur:*

Depth of surface being stripped is significantly different than anticipated.

Topsoil appears to contain contaminants.

Topsoil appears too compacted during spreading; may need to loosen by discing or scarifying.

### Maintenance

Inspect topsoiled areas frequently until vegetation is established.

Repair eroded or damaged areas and revegetate.

Repair sloughing on steep slopes—remove topsoil, roughen subgrade and respread topsoil.

Consult with a qualified design professional if drainage (wetness caused by seepage) or shallowness to bedrock (less than 24") is involved.

## References

### BMPs from Volume 1

#### Chapter 4

Land Grading (LG)

4-16

Mulching (MU)

4-48

Temporary Seeding (TS)

4-103

## Dust Control (DC)



### Practice Description

Dust control includes a wide range of techniques that prevent or reduce movement of wind-borne soil particles (dust) during land disturbing activities. This practice applies to construction routes and other disturbed areas where on-site and off-site damage or hazards may occur if dust is not controlled.

### Planning Considerations

Construction activities that disturb soil can be a significant source of air pollution. Large quantities of dust can be generated, especially in “heavy” construction activities such as land grading for road construction and commercial, industrial, or subdivision development.

The scheduling of construction operations so that the least amount of area is disturbed at one time is important in planning for dust control.

The greatest dust problems occur during dry periods. Therefore, to the extent practicable, do not expose large areas of bare soil during drought conditions.

Where wind erosion is a potential cause of dust problems, preserving vegetation should be considered as a passive measure. Leave undisturbed buffer areas between graded areas wherever possible.

Installing temporary- or permanent- surface stabilization measures immediately after completing land grading will minimize dust problems.

## **Design Criteria and Construction**

Dust-control requirements should be designed by a qualified design professional and plans and specifications should be made available to field personnel prior to start of construction. Whenever possible, leave vegetated-buffer areas undisturbed between graded areas.

## **Scheduling**

Schedule construction operations so that the smallest area is disturbed at any one time.

## **Permanent Methods**

### ***Vegetative Cover***

For disturbed areas not subject to traffic, vegetation provides the most practical method of dust control. Establish vegetative cover according to the *Permanent Seeding* or *Temporary Seeding Practice*.

### ***Topsoiling***

This entails covering the surface with less erosive soil material. See *Topsoiling Practice* for guidance.

### ***Stone***

Stone used to stabilize construction roads can also be effective for dust control. Stone should be spread a minimum of 6" thick over construction roads in the disturbed area. For heavily traveled roads or roads subjected to heavy loads, the stone thickness should be 8" to 10". A non-woven geotextile meeting the requirements shown in the Table DC-1 for Class IV geotextiles should be used under the rock when the subgrade is soft or the blow count is less than 10.

## **Temporary Methods**

### ***Mulches***

Mulch offers a fast, effective means of controlling dust when properly applied. See *Mulching Practice* for guidelines on planning and installing the practice.

### ***Temporary Vegetative Cover***

For disturbed areas where no activity is anticipated for 14 days or longer, temporary seeding can effectively control dust. Establish vegetative cover according to *Temporary Seeding Practice* guidelines.

### ***Calcium Chloride***

Calcium chloride may be applied by mechanical spreader as loose, dry granules or flakes at a rate that keeps the surface moist, but not so high as to cause water pollution or plant damage. Sites may need to be retreated because the product degrades over time.

Table DC-1 Requirements for Nonwoven Geotextile

Property	Test method	Class I	Class II	Class III	Class IV <sup>1</sup>
Tensile strength (lb) <sup>2</sup>	ASTM D 4632 grab test	180 minimum	120 minimum	90 minimum	115 minimum
Elongation at failure (%) <sup>2</sup>	ASTM D 4632	≥ 50	≥ 50	≥ 50	≥ 50
Puncture (pounds)	ASTM D 4833	80 minimum	60 minimum	40 minimum	40 minimum
Ultraviolet light (% residual tensile strength)	ASTM D 4355 150-hr exposure	70 minimum	70 minimum	70 minimum	70 minimum
Apparent opening size (AOS)	ASTM D 4751	As specified max. no.40 <sup>3</sup>	As specified max. no.40 <sup>3</sup>	As specified max. no.40 <sup>3</sup>	As specified max. no.40 <sup>3</sup>
Permittivity sec-1	ASTM D 4491	0.70 minimum	0.70 minimum	0.70 minimum	0.10 minimum

Table copied from NRCS Material Specification 592.

- <sup>1</sup> Heat-bonded or resin-bonded geotextile may be used for classes III and IV. They are particularly well suited to class IV. Needle-punched geotextile are required for all other classes.
- <sup>2</sup> Minimum average roll value (weakest principal direction).
- <sup>3</sup> U.S. standard sieve size.

**Spray-on Adhesives**

Spray-on adhesives may be used on mineral soils for dust control. Traffic must be kept off treated areas to prevent the product from becoming ineffective. Examples of spray-on adhesives for use in dust control are listed in Table DC-2.

Table DC-2 Spray-on Adhesives for Dust Control on Mineral Soil

Material	Water Dilution	Type of Nozzle	Apply Gal/Ac
Latex Emulsion	12.5:1	Fine Spray	235
Resin In Water	4:1	Fine Spray	300

**Chemical Stabilization (CHS)**

PAM may be used on mineral soils for dust control. Traffic must be kept off treated areas to prevent the product from becoming ineffective. The manufacturer or supplier shall provide written application methods for PAM and PAM mixtures. The application method shall ensure uniform coverage to the target and avoid drift to non-target areas including waters of the State. The manufacturer or supplier shall also provide written instructions to ensure proper safety, storage, and mixing of the product. Refer to the *Planning Considerations for Chemical Stabilization (PAM) Practice* for planning considerations before deciding to use this product.

***Sprinkling or Irrigation***

Sprinkling is especially effective for dust control on haul roads and other traffic routes. Sprinkle the site until the surface is wet. Repeat as needed. Also, bare areas may be kept wet with irrigation to control dust as an emergency treatment.

***Tillage***

Tillage is used to roughen the site and bring clods and moist soil to the surface. This is a temporary emergency measure that can be used on large, open, disturbed areas as soon as soil blowing starts. Begin tilling on the windward edge of the site. The depth of tillage is determined by the depth to moist soil and the amount of moist soil desired at the surface. In sandy soils, the depth to moist soil may make tillage impractical.

***Barriers***

A board fence, wind fence, sediment fence, hay bales, or similar barriers can control air currents and blowing soil. Place barriers perpendicular to prevailing air currents at intervals about 15 times the barrier height.



Figure 1 Sand Fence (<http://www.gulfmex.org/crp/7004/fence.jpg>)

***Street Cleaning***

Use a street sweeper to remove the source materials.

**Maintenance**

Check construction site during vehicular traffic or windy conditions to see if measures are working adequately. Maintain dust-control measures continuously throughout dry-weather periods, until all disturbed areas have been stabilized.

**References**

**BMPs from Volume 1**

**Chapter 4**

Topsoiling (TSG)	4-20
Chemical Stabilization (CHS)	4-25
Mulching (MU)	4-48
Permanent Seeding (PS)	4-53
Temporary Seeding (TS)	4-103

# Housekeeping Practices (HK)



## Practice Description

Housekeeping practices describes the various activities and measures, in addition to the specific practices used for erosion and sediment control that are essential during construction for the protection of environmental quality. Housekeeping is applicable at all construction sites.

## Planning Considerations

In addition to the sediment- and erosion-control practices included in the manual that deal directly with sediment and erosion control, some general housekeeping practices are essential to the pollution prevention aspect of a Stormwater Pollution Prevention Plan. Housekeeping addresses these practices. Included in the practice are the following different areas:

- Inspection and Maintenance Procedures
- Materials Inventory
- Spill Prevention and Material Management Practices
- Spill Controls
- Hazardous Products
- Air Emissions (excessive odor)
- Other Good Housekeeping Practices (i.e. fugitive spray, excessive noise and aesthetics)

## Design Criteria

### Inspection and Maintenance Procedures

The following inspection and maintenance procedures need to be followed to maintain adequate sediment and erosion controls:

- All control measures need to be inspected at least once per week and following any accumulation of rainfall of 1/2" or more within a 24-hour period.
- All measures need to be maintained in good working order. If a repair is necessary, it should be initiated within 24 hours of report.
- Silt fence and straw bales need to be inspected weekly for proper anchorage and leakage underneath. Silt fencing should also be inspected for tears.
- Built-up sediment needs to be removed from silt barriers when it has reached 1/2 of the height of the barrier. Sediment needs to be placed in a stabilized site to prevent re-entry into the same site or another entrapment area.
- Sediment basins need to be inspected for depth of sediment on a monthly basis and built-up sediment needs to be removed when 1/2 of the basin volume is filled.
- Temporary and permanent seeding and plantings need to be inspected for bare spots, washouts and healthy growth. A person should be designated to be responsible for maintaining planted areas until growth has reached 1" in height and the area planted has 70% ground cover.

### Materials Inventory

A materials list should be compiled for items that will be stored outside on the site during construction. For example:

\_\_\_\_\_ Pipe, fittings and joint compounds for underground utility piping  
 \_\_\_\_\_ Gravel and stone bedding material  
 \_\_\_\_\_ Concrete forming materials  
 \_\_\_\_\_ Other (specify) \_\_\_\_\_  
 \_\_\_\_\_  
 \_\_\_\_\_  
 \_\_\_\_\_

*NOTE: Fuels, oils and other petroleum products; forming oils and compounds; fertilizers; pesticides; strippers; detergents; cleaners; or any other hazardous or toxic compounds should not be stored outside on the site unless specifically agreed upon by all responsible parties, including those persons responsible for enforcing local ordinances and policies. On-site storage should meet all local, state and federal rules regarding secondary containment. Additionally, local ordinances may require fencing and security measures for storage of these products.*

---

## **Spill Prevention and Material Management Practices**

### ***Petroleum Products***

All vehicles kept on the site need to be monitored for leaks and receive regular preventive maintenance to reduce the chance of leakage. A Spill Prevention Control and Countermeasures (SPCC) plan should be developed for the facility to address the safe storage, handling and clean up of petroleum products and other chemicals. Petroleum products should be stored in tightly sealed containers, that are clearly labeled. If petroleum products are stored on site, a secondary containment facility will be required if the cumulative storage capacity of all tanks, greater than 55 gallons, at the site exceeds 1,320 gallons.

### ***Fueling & Servicing***

No fueling, servicing, maintenance, or repair of equipment or machinery should be done within 50 feet of a stream, or within 100 feet of a stream classified for public water supply (PWS), with special designation, protected vegetation (tree drip-line), or a sinkhole.

### ***Mud Tracking***

A stabilized construction entrance needs to be designated on the plan. The practice construction exit pad provides design details for planning such an entrance.

Only designated entrances should be used for construction access to the site. The General Contractor should be responsible for keeping mud cleaned from adjoining streets on a daily basis if needed.

### ***Concrete Trucks***

Concrete trucks should be allowed to wash only in locations where discharge is directed to a sediment basin. It is not permissible to discharge concrete wash directly to streams or storm drains. Alkalinity and chemical additives could be harmful to fish, stream bottom macroinvertebrates and wildlife.

### ***Disposal of Oil***

No fuels, oils, lubricants, solvents, or other hazardous materials can be disposed of on the site. All hazardous material must be properly disposed of in accordance with State law.

### ***Trash/Solid Waste***

The General Contractor is responsible for disposing of all solid waste from the site in accordance with State law. Dumpsters or other collection facilities must be provided as needed. Solid waste may not be buried on the site.

### ***Sanitary Waste***

The General Contractor is responsible for providing sanitary facilities on the site. Sanitary waste may be disposed only in locations having a State permit.

### **Other Discharges**

Water for pressure testing sanitary sewers, flushing water lines, sand blasting, concrete cleansing, etc., may be discharged only in approved areas. Discharge of hydrostatic test water may require additional permitting, particularly if chlorinated public water is used.

### **Spill Controls**

In addition to the good housekeeping practices and material management practices listed previously, the following procedures need to be followed for spill prevention and clean-up:

- Manufacturer's recommended methods for spill cleanup needs to be clearly posted and site personnel need to be made aware of the procedures and the location of the information and cleanup supplies. Refer to material safety data sheets (Material Safety Data Sheet).
- Material and equipment necessary for spill cleanup needs to be kept in the material storage area on-site. Equipment and materials include, but are not limited to; brooms, dust pans, mops, rags, gloves, goggles, absorbent clay (kitty litter), sand, sawdust, absorbent mats, and plastic and metal trash containers specifically for this purpose.
- All spills need to be cleaned up immediately after discovery and properly containerized for proper disposal. Burial is not acceptable.
- The spill area must be kept well ventilated and personnel need to wear appropriate protective clothing to prevent injury from contact with a hazardous substance.
- Spills of toxic or hazardous material must be reported immediately to the appropriate state or local government agency, regardless of the size.
- The spill prevention plan needs to be adjusted to include measures to prevent this type of spill from being repeated, and the plan needs to show how to clean up the spill if another one does occur.

### **Contaminated Soils**

Removal of contaminated soils and underground storage tanks should be based on information provided by the Mississippi Department of Environmental Quality following a proper site assessment.

### **Hazardous Products**

Products must be kept in original containers unless they are not resealable. If product is transferred to a new container, it must be properly marked and labeled.

Original labels and material safety data sheets should be retained.

If surplus product must be disposed, disposal must be done in accordance with Mississippi Department of Environmental Quality regulations.

## Air Emissions

Open burning must meet the criteria found in the State of Mississippi's Air Emissions Regulations found in APCS-1, Section 3.7. Other considerations are discussed below.

### **Burning**

Burning on the site may require a permit from the Mississippi Forestry Commission. County or city ordinances may also apply. Starting disposal fires with diesel fuel or old tires is not a recommended practice. The use of burn pits with fans to generate hot disposal fires decreases the fire disposal time and minimizes smoke.

### **Dust Control**

Apply measures that minimize dust. Stabilizing areas with mulch as soon as possible can minimize dust. Watering should be provided in unstabilized areas (See *Dust Control Practice*).

## Other Good Housekeeping Practices

In addition to the foregoing, the following good housekeeping practices need to be followed during the construction of the project:

- An effort should be made to store only enough products to do the job.
- All materials stored on-site should be stored in a neat, orderly manner in their appropriate containers and, if possible, under a roof or other enclosure.
- Products should be kept in their original containers with the original manufacturer's label.
- Whenever possible, all of a product should be used up before disposing of the container.
- Manufacturer's recommendations for proper use and disposal must be followed (see Material Safety Data Sheet).
- The site superintendent should inspect daily to ensure proper usage, storage and disposal of materials.
- Fertilizers need to be applied only in the minimum amounts recommended by the manufacturer.
- All paint containers need to be tightly sealed and stored when not required for use. Excess paint shall not be dumped into the storm sewer system but should be properly disposed of according to manufacturer's instructions (see Material Safety Data Sheet) and State regulations.
- The site should be kept clean and well groomed (trash picked up regularly, weeds mowed and signs maintained).
- Offsite fugitive spray from dust control, sand blasting and pressure washing must be minimized to the extent possible.
- Locate activities that generate odors and noise as far from surrounding properties as possible (this item includes portable toilets, burn sites, fueling areas, equipment repair areas and dumpsters).

## References

### BMPs from Volume 1

#### Chapter 4

Dust Control (DC)

4-29

## Mulching (MU)



### Practice Description

Mulching is the application of plant residues such as straw or other suitable materials to the soil surface. Mulch protects the soil surface from the erosive force of raindrop impact and reduces the velocity of overland flow. It helps seedlings germinate and grow by conserving moisture, protecting against temperature extremes and controlling weeds. Mulch also maintains the infiltration capacity of the soil. Mulch can be applied to seeded areas to help establish plant cover. It can also be used in unseeded areas to protect against erosion over the winter or until final grading and shaping can be accomplished except in areas with concentrated flow.

### Planning Considerations

Surface mulch is the most effective, practical means of controlling runoff and erosion on disturbed land prior to vegetation establishment. Mulch absorbs the energy associated with raindrops and thereby minimizes soil-particle detachment, which is the initiation step of erosion.

Mulch also reduces soil moisture loss by evaporation, prevents crusting and sealing of the soil surface, moderates soil temperatures, and provides a suitable microclimate for seed germination.

Organic mulches such as straw, wood chips and shredded bark have been found to be very effective mulch materials. Materials containing weed and grass seeds that may compete with establishing vegetation should not be used. Also, decomposition of some wood products can tie up significant amounts of soil nitrogen, making it necessary to modify fertilization rates or add fertilizer with the mulch.

A variety of erosion-control blankets have been developed in recent years for use as mulch, particularly in critical areas such as waterways and channels. Various types of netting materials are also available to anchor organic mulches.

The choice of materials for mulching should be based on soil conditions, season, type of vegetation to establish, and size of the area. Properly applied and tacked mulch is always beneficial. Mulching is especially important when conditions of germination are not optimum, such as midsummer and early winter, and on difficult sites with cut slopes, or fill slopes and droughty soils.

Straw is the most commonly used material in conjunction with seeding. Wheat straw is the mostly commonly used straw, and can be spread by hand or with a mulch blower. If the site is susceptible to blowing wind, the straw should be tacked down with a tackifier, a crimper, or a disk to prevent loss. Some site developers always require that straw mulch be tacked by an approved method.

Wood chips are suitable for areas that will not be closely mowed, and around ornamental plantings. Chips do not require tacking. Because they decompose slowly, they must be treated with 12 pounds of nitrogen per ton to prevent nutrient deficiency in plants. They can be an inexpensive mulch if the chips are obtained from trees cleared on the site.

Wood fiber refers to short cellulose fibers applied as a slurry in hydroseeding operations. Wood-fiber hydroseeder slurries may be used to tack straw mulch on steep slopes, critical areas, and where harsh climatic conditions exist.

Compost, peanut hulls, and pine straw are organic materials that potentially make excellent mulches but may only be available locally or seasonally. Creative use of these materials may reduce costs.

Jute mesh or the various types of netting is very effective in holding mulch in place on waterways and slopes before grasses become established.

Erosion-control blankets promote seedling growth in the same way as organic mulches and are suited for use in areas with concentrated flows (see *Erosion-Control Blanket Practice*).

## **Design Criteria and Installation**

Mulching should be designed by a qualified design professional and plans and specifications should be made available to field personnel prior to start of construction.

### **Site Preparation**

Divert runoff water from areas above the site that will be mulched.

Remove stumps, roots, and other debris from the construction area.

Grade area as needed to permit the use of equipment for seeding, mulching, and maintenance. Shape area so that it is relatively smooth.

If the area will be seeded, follow seeding specifications in the design plan and apply mulch immediately after seeding.

### **Spreading the Mulch**

Select a mulch material based on the site and practice requirements, availability of material, and availability of labor and equipment. Table MU-1 lists commonly used mulches.

Uniformly spread organic mulches by hand or with a mulch blower at a rate which provides about 75% ground cover. When spreading straw mulch by hand, divide the area to be mulched into sections of approximately 1000 sq. ft. and place 70-90 pounds of straw (1 ½ to 2 bales) in each section to facilitate uniform distribution. Caution, an over-application of wheat straw will reduce stand success – do not over-apply wheat straw when mulching a seeding application!

Anchor straw- or wood-cellulose mulch by one of the following methods:

- Crimp with a weighted, straight, notched disc or a mulch-anchoring tool to punch the straw into the soil.
- Tack with a liquid tackifier designed to hold mulch in place. Use suitable spray equipment and follow manufacturer's recommendations.
- In more erosive areas, cover with netting, using a degradable natural or synthetic mesh. The netting should be anchored according to manufacturer's specifications (see *Erosion-Control Blanket Practice*).
- On steep slopes and other areas needing a higher degree of protection, use one of the following: 1) heavy natural nets without additional mulch; 2) synthetic netting with additional mulch or; 3) erosion control mats/blankets. These areas include grassed waterways, swales and diversion channels.
- Install netting and mats/blankets according to manufacturer's specifications making sure materials are properly anchored (see *Erosion-Control Blanket Practice*).

Table MU-1 Mulching Materials and Application Rates

<b>Material</b>	<b>Rate Per Acre and (Per 1000 ft.<sup>2</sup>)</b>	<b>Notes</b>
<b>Straw with Seed</b>	1 ½-2 tons (70 lbs-90 lbs)	Spread by hand or machine to attain 75% groundcover; anchor when subject to blowing.
<b>Straw Alone (no seed)</b>	2 ½-3 tons (115 lbs-160 lbs)	Spread by hand or machine; anchor when subject to blowing.
<b>Wood Chips</b>	5-6 tons (225 lbs-270 lbs)	Treat with 12 lbs. nitrogen/ton.
<b>Bark</b>	35 cubic yards (0.8 cubic yard)	Can apply with mulch blower.
<b>Pine Straw</b>	1-2 tons (45 lbs-90 lbs)	Spread by hand or machine; will not blow like straw.
<b>Peanut Hulls</b>	10-20 tons (450 lbs-900 lbs)	Will wash off slopes. Treat with 12 lbs. nitrogen/ton.

Liquid-mulch binders can also be used to tack mulch subject to being blown away by wind. Applications of liquid-mulch binders and tackifiers should be heaviest at the edges of areas and at crests of ridges and banks, to resist wind. Binders should be applied uniformly to the rest of the area. Binders may be applied after mulch is spread or may be sprayed into the mulch as it is being blown onto the soil. Applying straw and binder together is the most effective method. Liquid binders include an array of commercially available synthetic binders.

Straw mulch may also be anchored with lightweight plastic, cotton, jute, wire or paper netting which is stapled over the mulch. The manufacturer's recommendations on stapling netting should be followed.

### Verification of Installation

Check materials and installation for compliance with specifications.

### Common Problems

*Consult with qualified design professional if either of the following occurs:*

Variations in topography on site indicate the mulching materials will not function as intended; changes in plan may be needed.

Design specifications for mulching materials or seeding requirements cannot be met; substitution may be required. Unapproved substitutions could result in erosion or seeding failure.

*Problems that require remedial actions:*

Erosion, washout and poor plant establishment; repair eroded surface, reseed, re-mulch and anchor mulch.

Mulch is lost to wind or stormwater runoff; reapply mulch and anchor appropriately by crimping, netting or tacking.

## **Maintenance**

Inspect all mulched areas periodically and after rainstorms for erosion and damage to the mulch. Repair promptly and restore to original condition. Continue inspections until vegetation is well established. Keep mower height high if plastic netting is used to prevent netting from wrapping around mower blades or shaft.

## **References**

### **BMPs from Volume 1**

#### **Chapter 4**

Erosion-Control Blanket (ECB)	4-33
Permanent Seeding (PS)	4-53
Temporary Seeding (TS)	4-103

## Permanent Seeding (PS)



### Practice Description

Permanent seeding is the establishment of perennial vegetation on disturbed areas from seed. Permanent vegetation provides economical long-term erosion control and helps prevent sediment from leaving the site. This practice is used when vegetation is desired and appropriate to permanently stabilize the soil.

### Planning Considerations

The advantages of seeding over other means of establishing plants include the smaller initial cost, lower labor input, and greater flexibility of method.

Disadvantages of seeding include potential for erosion during the establishment stage, seasonal limitations on suitable seeding dates, and weather-related problems such as droughts.

The probability of successful plant establishment can be maximized through good planning. The selection of plants for permanent vegetation must be site specific. Factors that should be considered are types of soils, climate, establishment rate, and management requirements of the vegetation. Other factors that may be important are wear, mowing tolerance, and salt tolerance of vegetation.

Plant selection for permanent vegetation should be based on plant characteristics, site and soil conditions, time of year of planting, method of planting, and the intended use of the vegetated area. Climate factors can vary widely in Mississippi. Important plant attributes are discussed in *Vegetation Establishment for Erosion and Sediment Control* in Chapter 2.

Plant selection may include companion plants to provide quick cover on difficult sites, late seedings, or where the desired permanent cover may be slow to establish. Annuals are usually used for companion plants and should be selected carefully to prevent using a species that provide so much competition that it prevents the establishment of the desired species.

Seeding properly carried out within the optimum dates has a higher probability of success. It is also possible to have satisfactory establishment when seeding outside these dates. However, as plantings are deviated from the optimum dates, the probability of failure increases rapidly. Seeding dates should be taken into account in scheduling land-disturbing activities.

Site quality impacts both short-term and long-term plant success. Sites that have compacted soils, soils that are shallow to rock, or have textures that are too clayey or too sandy should be modified whenever practical to improve the potential for plant growth and long-term cover success.

The operation of equipment is restricted on slopes steeper than 3:1, severely limiting the quality of the seedbed that can be prepared. Provisions for establishment of vegetation on steep slopes can be made during final grading. In construction of fill slopes, for example, the last 4-6" might not be compacted. A loose, rough seedbed with irregularities that hold seeds and lime and fertilizer is essential for hydroseeding. Cut slopes should be roughened (see *Land Grading Practice*).

Proper mulching is critical to protect against erosion on steep slopes. When using straw, anchor with netting. On slopes steeper than 2:1, jute, excelsior, or synthetic matting may be required.

The use of irrigation (temporary or permanent) will greatly improve the success of vegetation establishment.

## **Design Criteria and Installation**

Prior to start of construction, plant materials, seeding rates and planting dates should be specified by a qualified design professional. Plans and specifications should be referred to by field personnel throughout the installation process.

Permanent seeding should be done during the specified planting period whenever possible. When sites are only available for planting outside of the recommended planting period, either an out-of-season permanent seeding, a temporary seeding, mulching or chemical stabilization will be more appropriate than leaving the surface bare for an extended period. If lime and fertilizer application rates are not specified, take soil samples during final grading from the top 6" in each area to be seeded. Submit samples to a soil testing laboratory for lime and fertilizer recommendations.

## **Scheduling**

The schedule for work at the site should consider the recommended planting period and whenever practical, the site work should accommodate seeding during the recommended planting period.

### Plant Selection

Select plants that can be expected to meet planting objectives. To simplify plant selection, use Figure PS-1 Geographical Areas for Species Adaptation and Table PS-1, Commonly Used Plants for Permanent Cover. Mixtures commonly specified by the Mississippi Department of Transportation are an appropriate alternative for plantings on rights-of-ways. Additional information related to plantings in Mississippi is found in Chapter 2 under the section *Vegetation for Erosion and Sediment Control*.

The plants used for temporary vegetation may be used for companion plants provided the seeding rate is reduced by one half. See the *Temporary Seeding Practice* for additional information on establishing temporary vegetation. **Ryegrass or other highly competitive plants should not be used as a companion plant.**

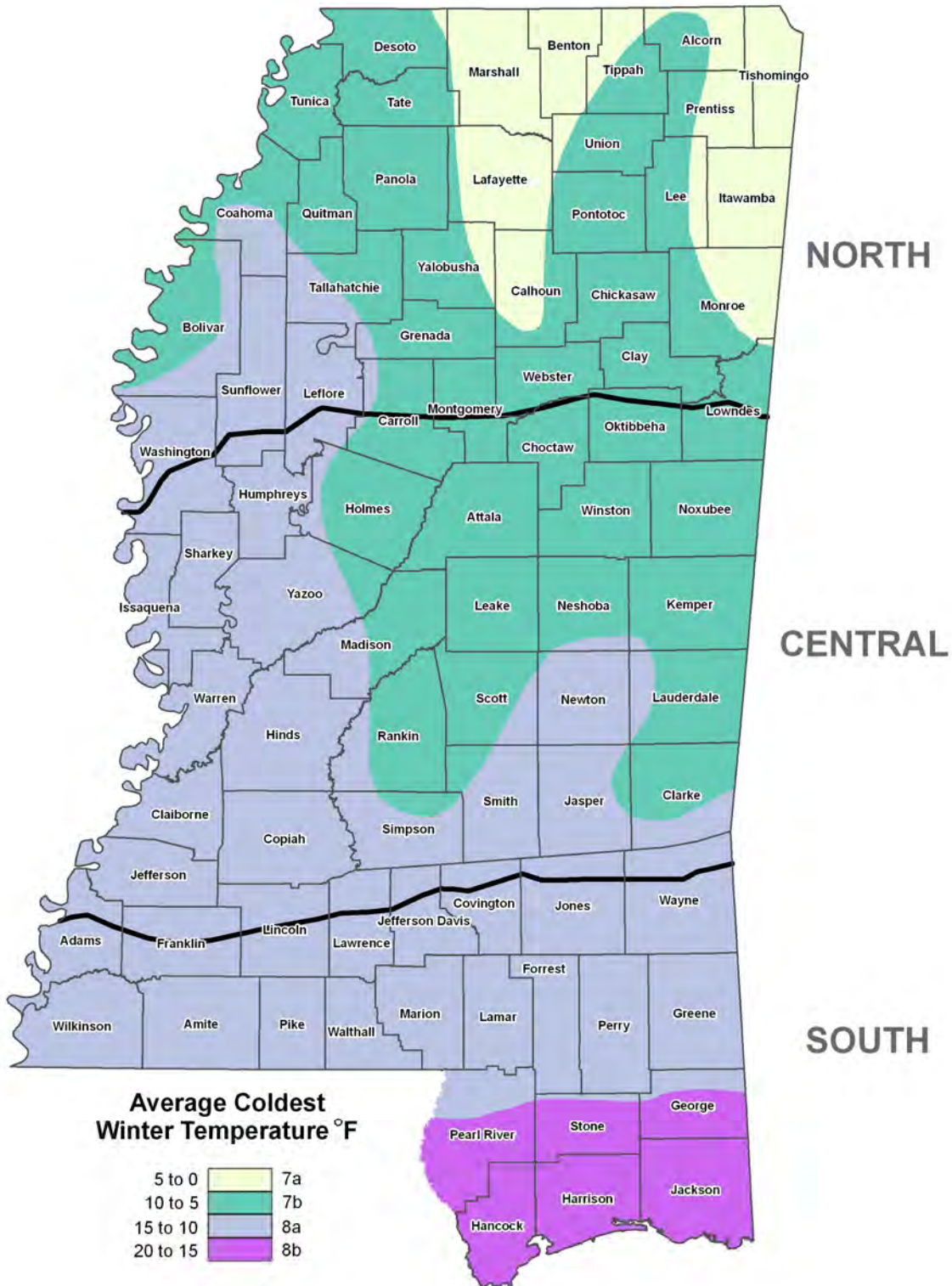

Figure PS-2 Geographical Areas for Species Adaptation

Table PS-1 Commonly Used Plants for Permanent Cover with Seeding Rates and Dates

Species	Seeding Rates/Ac	Planting Time	Desired pH Range	Fertilization Rate/Acre	Method of Establishment	Zone of Adaptability	Native / Introduced
<b>Common Bermuda</b>	15 lbs. alone 10lbs. mix	3/1 – 7/15 9/1 – 11/30	6.0 – 7.0	600 lbs. 13-13-13	Seed or sod	All	Introduced * Potential for Invasiveness
<b>Bahia</b>	40 lbs. alone 30 lbs. mix	3/1 – 7/15 9/1 – 11/30	6.0 – 7.0	600 lbs. 13-13-13	Seed	Central and South	Introduced
<b>Fescue</b>	40 lbs. alone 30 lbs. mix	9/1 – 11/30	6.0 – 7.0	600 lbs. 13-13-13	Seed	North and Central	Native
<b>Saint Augustine</b>	--	3/1 – 7/15	6.0 – 7.0	600 lbs. 13-13-13	Sod only	Central and South	Native
<b>Centipede</b>	4 lbs. alone 2.5 lbs mix	3/1 – 7/15	6.0 – 7.0	600 lbs. 13-13-13	Seed or sod	All	Introduced
<b>Carpet Grass</b>	15 lbs. alone 10 lbs. mix	3/1 – 7/15	6.0 – 7.0	600 lbs. 13-13-13	Seed or sod	All	Native
<b>Zoysia Grass</b>	--	3/1 – 7/15	6.0 – 7.0	600 lbs. 13-13-13	Sod only	All	Introduced
<b>Creeping Red Fescue</b>	30 lbs. alone 22.5 lbs. mix	9/1 – 11/30	6.0 – 7.0	600 lbs. 13-13-13	Seed	All	Native
<b>Weeping Lovegrass</b>	10 lbs. alone 5 lbs. mix	3/1 – 7/15	6.0 – 7.0	600 lbs. 13-13-13	Seed	All	Introduced
<b>*Wheat</b>	90 lbs. alone	9/1 – 11/30	6.0 – 7.0	600 lbs 13-13-13	Seed	All	Native
<b>*Ryegrass</b>	30 lbs.	9/1 – 11/30	6.0 – 7.0	600 lbs 13-13-13	Seed	All	Native
<b>*White Clover</b>	5 lbs.	9/1 – 11/30	6.0 – 7.0	400 lbs 6-24-24	Seed	All	Introduced
<b>*Crimson Clover</b>	15 lbs.	9/1 – 11/30	6.0 – 7.0	400 lbs 6-24-24	Seed	All	Introduced
<b>Sericea Lespedeza</b>	40 lbs.	3/1 – 7/15 9/1 – 11/30	6.0 – 7.0	400 lbs. 13-13-13	Seed	All	Introduced
<b>*Hairy Vetch</b>	30 lbs.	9/1 – 11/30	6.0 – 7.0	400 lbs 6-24-24	Seed	All	Introduced
<b>*Browntop Millet</b>	40 lbs. alone 15 lbs. mix	4/1 – 8/30	6.0 – 7.0	600 lbs 13-13-13	Seed	All	Introduced

\* Note on Annuals: For permanent seeding, annuals can only be used in a mixture with perennials.

## Seedbed Requirements

Establishment of vegetation should not be attempted on sites that are unsuitable due to compaction or inappropriate soil texture, poor drainage, concentrated overland flow, or steepness of slope until measures have been completed to correct these problems. To maintain a good stand of vegetation, the soil must meet certain minimum requirements as a growth medium. A good growth medium should have these attributes:

- Sufficient pore space to permit root penetration.
- Enough fine-grained soil material (silt and clay) to maintain adequate moisture and nutrient supply.
- Sufficient depth of soil to provide an adequate root zone. The depth to rock or impermeable layers such as hardpans should be 12" or more, except on slopes steeper than 2:1 where topsoiling is not feasible.
- A favorable pH range for plant growth, usually 6.0-6.5.
- Sufficient nutrients (nitrogen, phosphorus and potassium) for initial plant establishment.
- Freedom from large roots, branches, stones, or large clods. Clods and stones may be left on slopes steeper than 3:1 if they are to be hydroseeded.

If any of the above attributes are not met; i.e., if the existing soil is too dense, coarse, shallow or acidic to foster vegetation – chiseling, topsoil, or special amendments should be used to improve soil conditions. The soil conditioners described below may be beneficial or topsoil may be applied (for guidance on topsoiling see *Topsoiling Practice*). These amendments should only be necessary where soils have limitations that make them poor for plant growth or for turf establishment.

- Peat-appropriate types are sphagnum moss peat, reed-sedge peat, or peat humus, all from fresh-water sources. Peat should be shredded and conditioned in storage piles for at least 6 months after excavation.
- Sand-should be clean and free of toxic materials.
- Vermiculite-use horticultural grade.
- Rotted manure-use stable or cattle manure not containing undue amounts of straw or other bedding materials.
- Thoroughly rotted sawdust-should be free of stones and debris. Add 6 lbs of nitrogen to each cubic yard.

## Soil Amendments

### *Liming Materials*

Lime (Agricultural limestone) should have a neutralizing value of not less than 90 percent calcium carbonate equivalent and 90 percent will pass through a 10-mesh sieve and 50 percent will pass through a 60-mesh sieve.

Selma chalk should have a neutralizing value of not less than 80-percent calcium carbonate equivalent and 90 percent will pass through a 10-mesh sieve.

Other liming materials that may be selected should be provided in amounts that provide equal value to the criteria listed for agricultural lime or be used in combination with agricultural limestone or Selma chalk to provide equivalent values to agricultural limestone.

### **Plant Nutrients**

Commercial grade fertilizers that comply with current Mississippi Fertilizer Laws should be used to supply nutrients required to establish vegetation.

### **Rates of Soil Amendments**

Lime and fertilizer needs should be determined by soil tests. Soil testing is performed by the Mississippi State University Extension Service Soil Testing Laboratory and provides recommendations based on field tests on Mississippi soils. The local county Cooperative Extension Service can provide information on obtaining soil tests. Commercial laboratories that make recommendations based on soil analysis may be used.

When soil tests are not available, use the following rates for application of soil amendments.

### **Lime (Agricultural Limestone or Equivalent – see Liming Materials)**

Sandy soils: Use 1 ton/acre (exception on sandy soils – if the cover will be tall fescue and clover use 2 tons/acre).

Clayey soils: 2 tons/acre.  
(Do not apply lime to alkaline soils).

### **Fertilizer**

Grasses alone: Use 400 lbs/acre of 8-24-24 or the equivalent. Apply 30 lbs of additional nitrogen when grass has emerged and begun growth (approximately 0.8lbs/1000 ft<sup>2</sup>).

Grass-legume mixtures: Use 800 to 1200 lbs/acre of 5-10-10 or the equivalent.

Legumes Alone: Use 800 to 1200 lbs/acre of 0-10-10 or the equivalent.

*Note: Fertilizer can be blended to meet exact fertilizer recommendations. Take soil test recommendations to local fertilizer dealer for bulk fertilizer blends. This may be more economical than bagged fertilizer.*

### **Application of Soil Amendments**

Apply lime and fertilizer evenly and incorporate into the top 6" of soil by disking, chiseling, or other suitable means during seedbed preparation. Operate machinery on the contour.

### **Seedbed Preparation**

Install necessary sediment-control practices before seedbed preparation and complete grading according to the approved plan.

Grade and loosen the soil to a smooth, firm surface to enhance rooting of seedlings and reducing rill erosion. Break up large clods and loosen compacted, hard, or crusted-soil surfaces with a disk, ripper, chisel, harrow or other tillage equipment. Avoid preparing the seedbed under excessively wet conditions. Operate the equipment on the contour.

For broadcast seeding and drilling, tillage, as a minimum, should adequately loosen the soil to a depth of at least 6", alleviate compaction, and smooth and firm the soil for the proper placement of seed.

For no-till drilling, the soil surface does not need to be loosened unless the site has surface compaction.

Incorporate lime and fertilizer to a depth of at least 6" with a disk or rotary tiller on slopes of up to 3:1. On steeper slopes, lime and fertilizer may be applied to the surface without incorporation. Lime and fertilizer may be applied through hydroseeding equipment; however, fertilizer should not be added to the seed mixture during hydroseeding. Lime may be added with the seed mixture.

## **Planting Methods**

### **Seeding**

Use certified seed for permanent seeding whenever possible. Certified seed is inspected by the Mississippi Crop Improvement Association to meet high quality standards and will be tagged with a "Certified Seed" tag. (Note: all seed sold in Mississippi is required by law to be tagged to identify seed purity, germination, and presence of weed seeds. Seed must meet state standards for content of noxious weeds.)

Seeding dates are determined using Figure PS-1 and Table PS-1.

Inoculate legume seed with the *Rhizobium* bacteria appropriate to the species of legume. Details of legume inoculation are located in Chapter 2 in the part on *Vegetation for Erosion and Sediment Control* under Inoculation of Legumes.

Seed should be uniformly planted with a cyclone seeder, a drill seeder, a cultipacker seeder, or by hand on a fresh, firm, friable seedbed. If the seedbed has been sealed by rainfall, it should be disked so the seed will be sown into a freshly prepared seedbed.

When using broadcast-seeding methods, subdivide the area into workable sections and determine the amount of seed needed for each section. Apply one-half the seed while moving back and forth across the area, making a uniform pattern; then apply the second half in the same way, but moving at right angles to the first pass.

Cover broadcast seed by raking or chain dragging; then firm the surface with a roller or cultipacker to provide good seed contact. Small grains should be planted no more than 1" deep and grasses and legume seed no more than ½" deep.

### **Hydroseeding**

Surface roughening is particularly important when hydroseeding, as a roughened slope will provide some natural coverage for lime, fertilizer, and seed. The surface should not be compacted or smooth. Fine seedbed preparation is not necessary for hydroseeding operations; large clods, stones, and irregularities provide cavities in which seeds can lodge.

Mix seed, inoculant if required, and a seed carrier with water and apply as a slurry uniformly over the area to be treated. The seed carrier should be a cellulose fiber, natural wood fiber or other approved fiber mulch material which is dyed an appropriate color to

facilitate uniform application of seed. Use the correct legume inoculant at 4 times the recommended rate when adding inoculant to a hydroseeder slurry. The mixture should be applied within one hour after mixing to reduce damage to seed.

Fertilizer should not be mixed with the seed-inoculant mixture because fertilizer salts may damage seed and reduce germination and seedling vigor.

Fertilizer may be applied with a hydroseeder as a separate operation after seedlings are established.

Agricultural lime is usually applied as a separate operation and spread in dry form. It is not normally applied with a hydraulic seeder because it is abrasive and, also, may clog the system. On the other hand, liquid lime is applied with a hydraulic seeder but because of cost is used primarily to provide quick action for benefit of plants during their seedling stage with the bulk of liming needs to be provided by agricultural lime. Dry lime may be applied with the fertilizer mixture.

### ***Sprigging***

Hybrid Bermuda grass cannot be grown from seed and must be planted vegetatively. Vegetative methods of establishing common and hybrid Bermuda grass, centipede grass and zoysia include sodding, plugging and sprigging (see *Sodding Practice*).

When sprigs are planted with a sprigging machine, furrows should be 4-6" deep and 2 feet apart. Place sprigs no farther than 2 feet apart in the row and so that at least one rooting node is in the furrow.

Broadcasting of sprigs is not recommended as the practice requires additional vegetative material and is an unreliable method of planting. Hand planting of sprigs is recommended instead with furrows 4-6" deep and 2 feet apart. Place sprigs no farther than 2 feet apart in the row and so that at least one rooting node is in the furrow.

### ***Mulching***

The use of mulch provides instant cover and helps ensure establishment of vegetation under normal conditions and is essential to seeding success under harsh site conditions (see *Mulching Practice*). Harsh site conditions include slopes steeper than 3:1 and adverse soils (shallow, rocky, or high in clay or sand). Areas with concentrated flow should be treated differently and require sod, a hydromulch formulated for channels or an appropriate erosion control blanket.

### ***Irrigation***

Moisture is essential for seed germination and vegetation establishment. Supplemental irrigation can be very helpful in assuring adequate stands in dry seasons or to speed development of full cover. It is a requirement for establishment of vegetation from sod and sprigs and should be used elsewhere when feasible. However, irrigation is rarely critical for low-maintenance vegetation planted at the appropriate time of the year.

Water application rates must be carefully controlled to prevent runoff. Inadequate or excessive amounts of water can be more harmful than no supplemental water.

### **Installation Verification**

Check materials and installation for compliance with specifications during installation of products.

### **Common Problems**

*Consult with a qualified design professional if the following occurs:*

Design specifications for seed variety, seeding dates or mulching cannot be met; substitutions may be required. Unapproved substitutions could lead to failure.

Seeding at the wrong time of the year results in an inadequate stand. Reseed according to specifications of a qualified design professional (see recommendations under *Maintenance*)

Inadequate mulching results in an inadequate stand, bare spots or eroded areas—prepare seedbed, reseed, cover seed evenly and tack or tie down mulch, especially on slopes, ridges and in channels (see recommendations under *Maintenance*).

### **Maintenance**

Generally, a stand of vegetation cannot be determined to be fully established until vegetative cover has been maintained for 1 year from planting.

#### **Reseeding**

Inspect seedlings monthly for stand survival and vigor. Also, inspect the site for erosion.

If stand is inadequate identify the cause of failure (choice of plant materials, lime and fertilizer quantities, poor seedbed preparation or weather) and take corrective action. If vegetation fails to grow, have the soil tested to determine whether pH is in the correct range or nutrient deficiency is a problem.

Stand conditions, particularly the coverage, will determine the extent of remedial actions such as seedbed preparation and reseeding. A qualified design professional should be consulted to advise on remedial actions. Consider drill seeding where possible.

Eroded areas should be addressed appropriately by filling and/or smoothing, and reapplication of lime, fertilizer, seed and mulch.

#### **Fertilizing**

Satisfactory establishment may require refertilizing the stand in the second growing season. Follow soil test recommendations or the specifications provided to establish and maintain the planting.

#### **Mowing**

Mow vegetation on structural practices such as embankments and grass-lined channels to prevent woody plants from invading.

Other areas should be mowed to compliment the use of the site.

Certain species can be weakened by mowing regimes that significantly reduce their food reserves stored for the next growing season: fescue should not be mowed close during the summer; sericea should not be mowed close in late summer.

Bermuda grass is tolerant of most mowing regimes and can be mowed often and close, if so desired, during its growing season.

## References

### Volume 1

#### Chapter 2

Vegetation for Erosion and Sediment Control 2-10

#### Chapter 4

Land Grading (LG) 4-16

Topsoiling (TSG) 4-20

Mulching (MU) 4-48

Temporary Seeding (TS) 4-103

### Appendices Volume

#### Appendix G

MDOT Vegetation Schedule G-1

## Temporary Seeding (TS)



### Practice Description

Temporary seeding is the establishment of fast-growing annual vegetation from seed on disturbed areas. Temporary vegetation provides economical erosion control for up to a year and reduces the amount of sediment moving off the site.

This practice applies where short-lived vegetation can be established before final grading or in a season not suitable for planting the desired permanent species. It helps prevent costly maintenance operations on other practices such as sediment basins and sediment barriers. In addition, it reduces problems of mud and dust production from bare soil surfaces during construction. Temporary or permanent seeding is necessary to protect earthen structures such as dikes, diversions, grass-lined channels and the banks and dams of sediment basins.

### Planning Considerations

Temporary vegetative cover can provide significant short-term erosion and sediment reduction before establishing perennial vegetation.

Temporary vegetation will reduce the amount of maintenance associated with sediment basins.

Temporary vegetation is used to provide cover for no more than 1 year. Permanent vegetation should be established at the proper planting time for permanent vegetative cover.

Certain plants species used for temporary vegetation will produce large quantities of residue which can provide mulch for establishment of the permanent vegetation.

Proper seedbed preparation and selection of appropriate species are important with this practice. Failure to follow establishment guidelines and recommendations carefully may result in an inadequate or short-lived stand of vegetation that will not control erosion.

The selection of plants for temporary vegetation must be site specific. Factors that should be considered are types of soils, climate, establishment rates, and management requirements of the vegetation. Other factors that may be important are wear, mowing tolerance, and salt tolerance of vegetation.

Seeding properly carried out within the optimum dates has a higher probability of success. It is also possible to have satisfactory establishment when seeding outside these dates. However, as plantings are deviated from the optimum dates, the probability of failure increases rapidly. Seeding dates should be taken into account in scheduling land-disturbing activities.

Site quality impacts both short-term and long-term plant success. Sites that have compacted soils should be modified whenever practical to improve the potential for plant growth.

The operation of equipment is restricted on slopes steeper than 3:1, severely limiting the quality of the seedbed that can be prepared. Provisions for establishment of vegetation on steep slopes can be made during final grading. In construction of fill slopes, for example, the last 4-6" might not be compacted. A loose, rough seedbed with irregularities that hold seeds and fertilizer is essential for hydroseeding. Cut slopes should be roughened (see practice *Land Grading*).

Good mulching practices are critical to protect against erosion on steep slopes. When using straw, anchor with netting or asphalt. On slopes steeper than 2:1, jute, excelsior, or synthetic matting may be required to protect the slope.

The use of irrigation (temporary or permanent) will greatly improve the success of vegetation establishment.

## **Design Criteria and Installation**

Prior to start of installation, plant materials, seeding rates and planting dates should be specified by a qualified design professional. Plans and specifications should be referred to by field personnel throughout the installation process.

### **Scheduling**

Plantings should be made during the specified planting period if possible. When sites become available to plant outside of the recommended planting period, either temporary seeding, mulching or chemical stabilization will be more appropriate than leaving the surface bare for an extended period. If lime and fertilizer application rates are not specified, take soil samples during the final grading operation from the top 6" in each area to be seeded. Submit samples to a soil testing laboratory for lime and fertilizer recommendations.

## Plant Selection

Select plants that can be expected to meet planting objectives. To simplify plant selection, use Table TS-1, *Commonly Used Plants for Temporary Cover* and Figure TS-1, *Geographical Areas for Species Adaptation and Seeding Dates*. Seeding mixtures commonly specified by the Mississippi Department of Transportation are an appropriate alternative for plantings on rights-of-ways. Additional information related to plantings in Mississippi is found in Chapter 2 in the section *Non-woody Vegetation for Erosion and Sediment Control*.

Table TS-1 Commonly Used Plants for Temporary Cover

Species	Seeding Rates/Ac	Planting Time	Desired pH Range	Fertilization Rate/Acre	Method of Establishment	Zone of Adaptability
<b>Wheat</b>	90 lbs. alone	9/1 – 11/30	6.0 – 7.0	600 lbs. 13-13-13	Seed	All
<b>Ryegrass</b>	30 lbs.	9/1 – 11/30	6.0 – 7.0	600 lbs. 13-13-13	Seed	All
<b>White Clover</b>	5 lbs	9/1 – 11/30	6.0 – 7.0	400 lbs. 13-13-13	Seed	All
<b>Crimson Clover</b>	25 lbs. alone 15 lbs. mix	9/1 – 11/30	6.0 – 7.0	400 lbs. 13-13-13	Seed	All
<b>Hairy Vetch</b>	30 lbs.	9/1 – 11/30	6.0 – 7.0	400 lbs. 13-13-13	Seed	All
<b>Browntop Millet</b>	40 lbs. alone 15 lbs. mix	4/1 – 8/30	6.0 – 7.0	600 lbs. 13-13-13	Seed	All

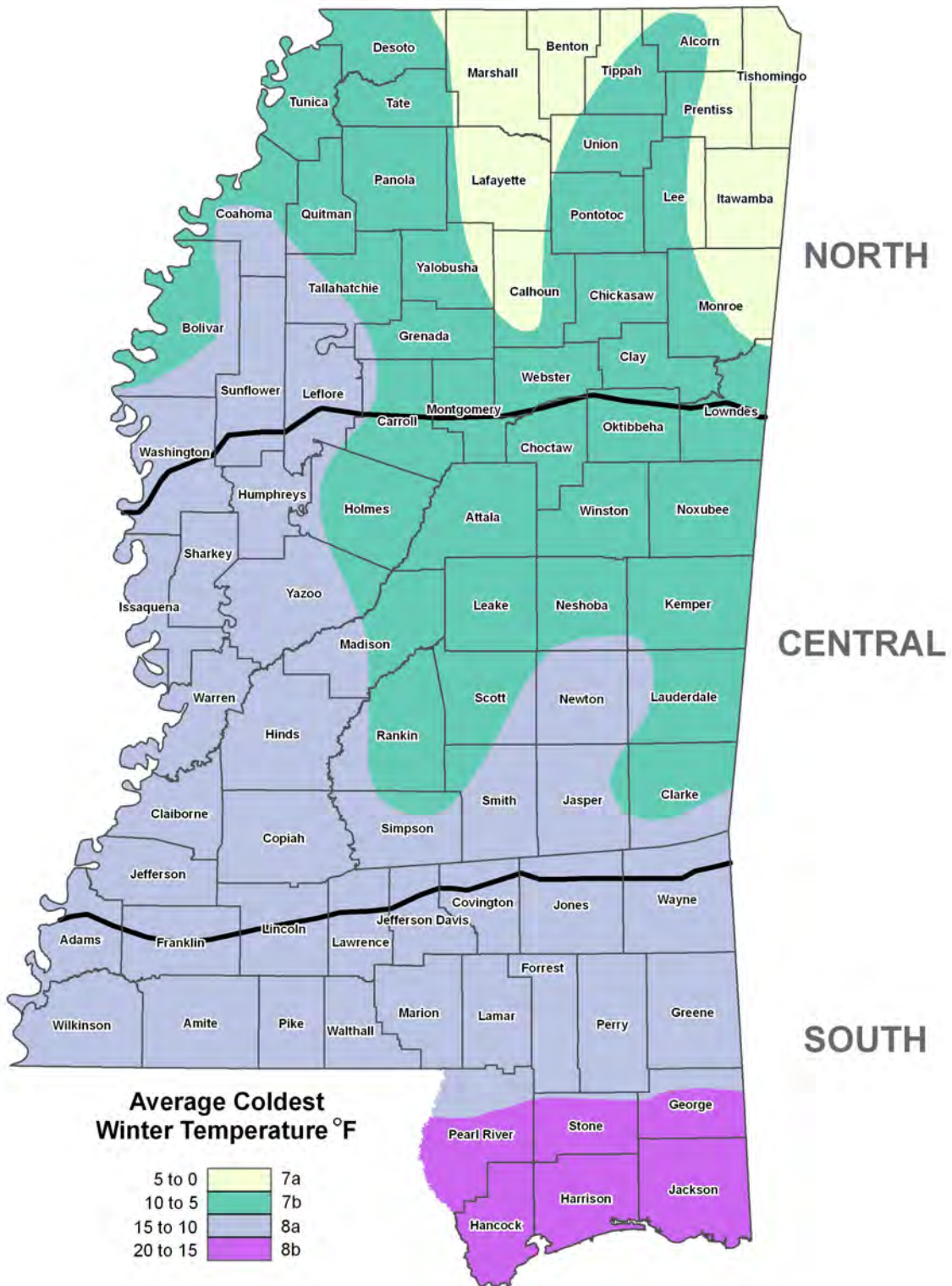

Figure TS- 1 Geographical Areas for Species Adaptation

**Site Preparation and Soil Amendments**

Complete grading and shaping before applying soil amendments, if needed, to provide a surface on which equipment can safely and efficiently be used to apply soil amendments and accomplish seedbed preparation and seeding. Incorporate lime and fertilizer into the top 6" of soil during seedbed preparation.

**Lime**

Apply lime according to soil-test recommendations. If a soil test is not available, use 1 ton of agricultural limestone or equivalent per acre on coarse-textured soils and 2 tons per acre on fine textured soils. Do not apply lime to alkaline soils or to areas that have been limed during the preceding 2 years. Other liming materials that may be selected should be provided in amounts that provide equal value to the criteria listed for agricultural lime or be used in combination with agricultural limestone or Selma chalk to provide equivalent values to agricultural limestone.

**Fertilizer**

Apply fertilizer according to soil-test results. If a soil test is not available, apply 8-24-24 fertilizer.

When vegetation has emerged in a stand and is growing, 30 to 40 lbs/acre (approximately 0.8 lbs/1000 ft<sup>2</sup>) of additional nitrogen fertilizer should be applied.

*Note: Fertilizer can be blended to meet exact fertilizer recommendations. Take soil-test recommendations to local fertilizer dealer for bulk-fertilizer blends. This may be more economical than bagged fertilizer.*

**Seedbed Preparation**

Good seedbed preparation is essential to successful plant establishment. A good seedbed is well pulverized, loose, and smooth. If soils become compacted during grading, loosen them to a depth of 6" to 8" using a ripper or chisel plow.

If rainfall has caused the surface to become sealed or crusted, loosen it just prior to seeding by disking, raking, harrowing, or other suitable methods. When hydroseeding methods are used, the surface should be left with a more irregular surface of clods.

**Planting Methods****Seeding**

Evenly apply seed using a cyclone seeder (broadcast), drill seeder, cultipacker seeder, or hydroseeder. Broadcast seeding and hydroseeding are appropriate for steep slopes where equipment cannot operate safely. Small grains should be planted no more than 1" deep, and grasses and legumes no more than ½" deep. Seed that are broadcast must be covered by raking or chain dragging, and then lightly firmed with a roller or cultipacker.

**Hydroseeding**

Surface roughening is particularly important when hydroseeding, as a roughened slope will provide some natural coverage for lime, fertilizer, and seed. The surface should not be compacted or left smooth. Fine seedbed preparation is not necessary

for hydroseeding operations; large clods, stones, and irregularities provide cavities in which seeds can lodge.

Mix seed, use an inoculant if required, and mix a seed carrier with water and apply as slurry uniformly over the area to be treated. The seed carrier should be a cellulose fiber, natural-wood fiber or other approved fiber-mulch material which is dyed an appropriate color to facilitate uniform application of seed. Use the correct legume inoculant at 4 times the recommended rate when adding inoculant to a hydroseeder slurry. The mixture should be applied within one hour after mixing to reduce damage to seed.

Fertilizer should not be mixed with the seed-inoculant mixture because fertilizer salts may damage seed and reduce germination and seedling vigor. Fertilizer may be applied with a hydroseeder as a separate operation after seedlings are established.

## **Mulching**

The use of an appropriate mulch provides instant cover and helps ensure establishment of vegetative cover under normal conditions and is essential to seeding success under harsh site conditions (see the *Mulching Practice* for guidance). Harsh site conditions include the following: slopes steeper than 3:1 and adverse soils (soils that are shallow to rock, rocky, or high in clay or sand). Areas with concentrated flow should be treated differently and require a hydromulch formulated for channels or use of an appropriate erosion control blanket.

## **Verification of Installation**

Check materials and installation for compliance with specifications during installation of products.

## **Common Problems**

*Consult with a qualified design professional if the following occurs:*

Design specifications for seed variety, seeding dates or mulching cannot be met; substitutions may be required. Unapproved substitutions could lead to failure.

Seeding outside of the recommendations results in an inadequate stand. Reseed according to specifications of a qualified design professional (see recommendations under Maintenance).

## **Maintenance**

### **Reseeding**

Inspect seedings weekly until a stand is established and at least monthly thereafter for stand survival and vigor. Also, inspect the site for erosion.

Eroded areas should be addressed appropriately by filling and/or smoothing, and a reapplication of lime, fertilizer, seed and mulch.

A stand should be uniform and dense for best results. Stand conditions, particularly the vegetative coverage, will determine the extent of remedial actions, such as seedbed preparation and reseeded. A qualified design professional should be consulted to advise on remedial actions. Consider no-till planting.

**Fertilizing**

If vegetation fails to grow, have the soil tested to determine whether its pH is in the correct range or whether nutrient deficiency is a problem.

Satisfactory establishment may require refertilizing the stand, especially if the planting is made early in the planting season. Follow soil-test recommendations or the specifications provided to establish the planting.

**Mowing**

Temporary plantings may be mowed and baled or simply mowed to complement the use of the site.

Millet, rye, and wheat may be mowed, but no lower than 6" (closer mowing may damage the stand).

Ryegrass is tolerant of most mowing regimes and may be mowed often and as close as 4" to 6" if this regime is started before it attains tall growth (over 8").

Bermuda grass is tolerant of most mowing regimes and can be mowed often and close, if so desired, during its growing season.

**References**

**Volume 1**

**Chapter 2**

Vegetation for Erosion and Sediment Control 2-10

**Chapter 4**

Land Grading (LG) 4-16

Topsoiling (TSG) 4-20

Mulching (MU) 4-48

Permanent Seeding (PS) 4-53

**Appendices Volume**

**Appendix G**

MDOT Vegetation Schedule G-1

## Check Dam (CD)

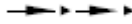

### Practice Description

A check dam is a small barrier or dam constructed across a swale, drainage ditch or other area of concentrated flow for the purpose of reducing channel erosion. Channel erosion is reduced because check dams flatten the gradient of the flow channel and slow the velocity of channel flow. Most check dams are constructed of rock, but hay bales, logs and other materials may be acceptable. Contrary to popular opinion, most check dams trap an insignificant volume of sediment.

This practice applies in small open channels and drainageways, including temporary and permanent swales. It is not to be used in a live stream. Situations of use include areas in need of protection during establishment of grass and areas that cannot receive a temporary or permanent non-erodible lining for an extended period of time.

### Planning Considerations

Check dams are used in concentrated flow areas to provide temporary channel stabilization during the intense runoff periods associated with construction disturbances. Check dams may be constructed of rock, logs, hay bales or other suitable material, including manufactured products. MDOT Drawing ECD-4 at the end of this practice shows the typical application of check dam structures. Most check dams are constructed of rock. Rock may not be acceptable in some installations because of aesthetics; therefore, alternative types of check dams need to be considered.

### Rock check dams

Rock check dams (Figures CD-1 and CD-2) are usually installed with backhoes or other suitable equipment, but hand labor is likely needed to complete most installations to the quality needed. The rock is usually purchased, and some locations in the state may not have rock readily available. The use of rock should be considered carefully in areas to be

mowed. Some rock may be washed away during heavy rain events and should be removed before each mowing operation. Additional installation drawings are provided at the end of this practice as MDOT Drawings ECD-8 and ECD-9.

### Log check dams

Log check dams (Figure CD-3) are more economical from a materials cost standpoint since logs can usually be salvaged from clearing operations. The time and labor required would be greater for log check dams. Increased labor costs would offset the reduced material costs. Log check dams would not be permanent but may last long enough to get grass linings established.

### Hay bale check dams

Check dams constructed of hay bales (Figure CD-4) have the shortest life of the materials discussed and are only used as a temporary means to help establish a channel to vegetation. MDOT Drawing ECD-5 is provided at the end of this practice and shows more specifics for hay bale check dams. MDOT Drawing ECD-6 shows typical details for a straw wattle ditch check as an alternative to hay bale check dams. Hay bale check dams should not be used where permanent watercourse protection is needed and should be used only in concentrated-flow areas where only minimal runoff occurs.

**Without proper installation, which is rarely done, hay bale check dams always fail.**

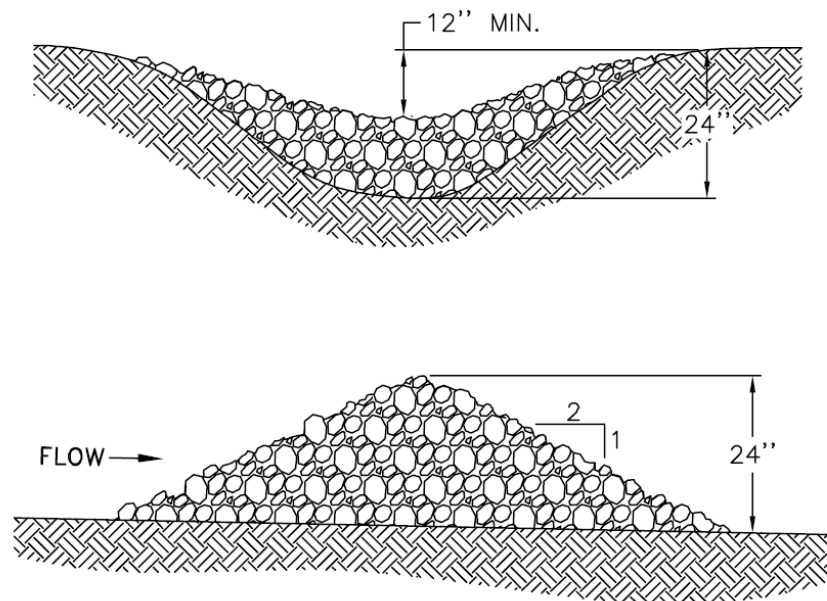

Figure CD-1 Profile of Typical Rock Check Dams

Check dams should be planned to be compatible with the other features such as streets, walks, trails, sediment basins and rights-of-way or property lines. Check dams are normally constructed in series, and the dams should be located at a normal interval from other grade controls such as culverts or sediment basins.

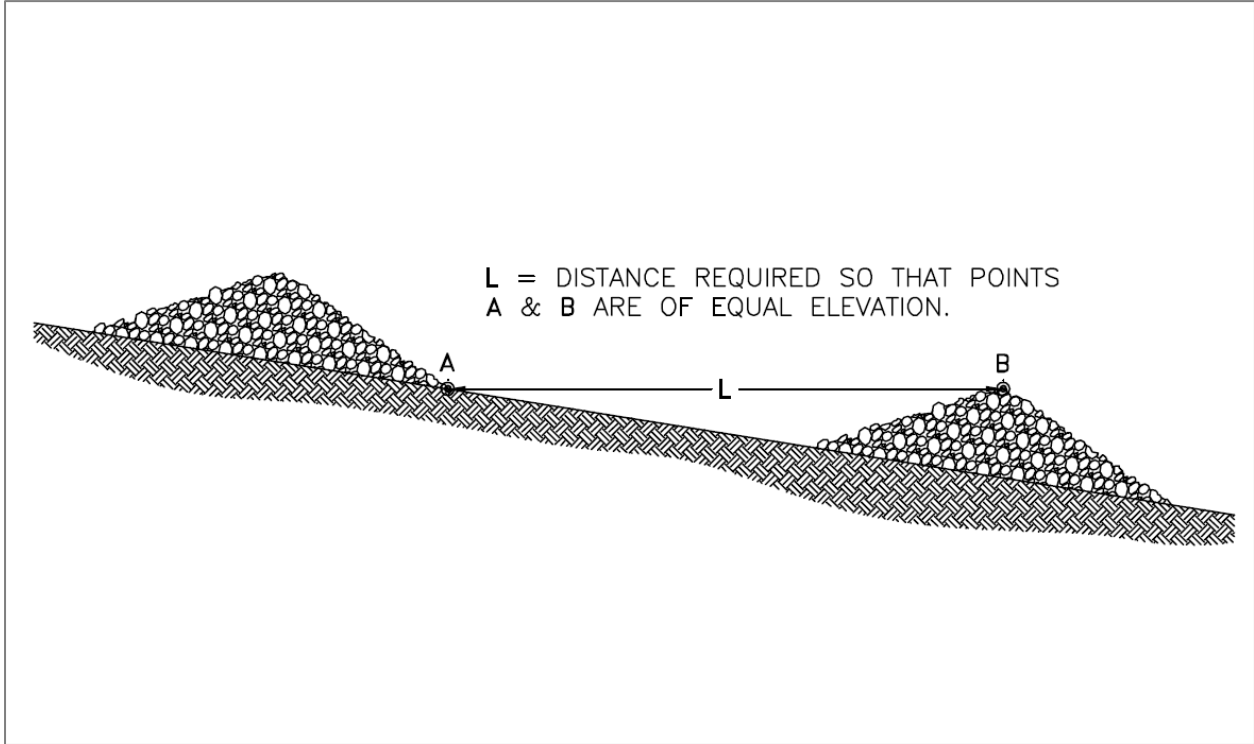

Figure CD-2 Cross Section of Typical Rock Check Dam

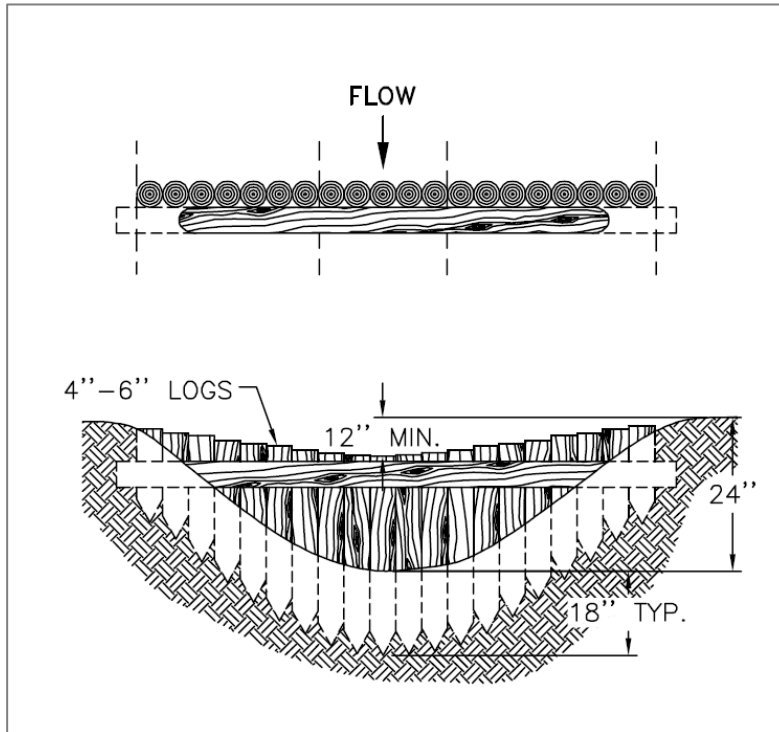

Figure CD-3 Typical Log Check Dam

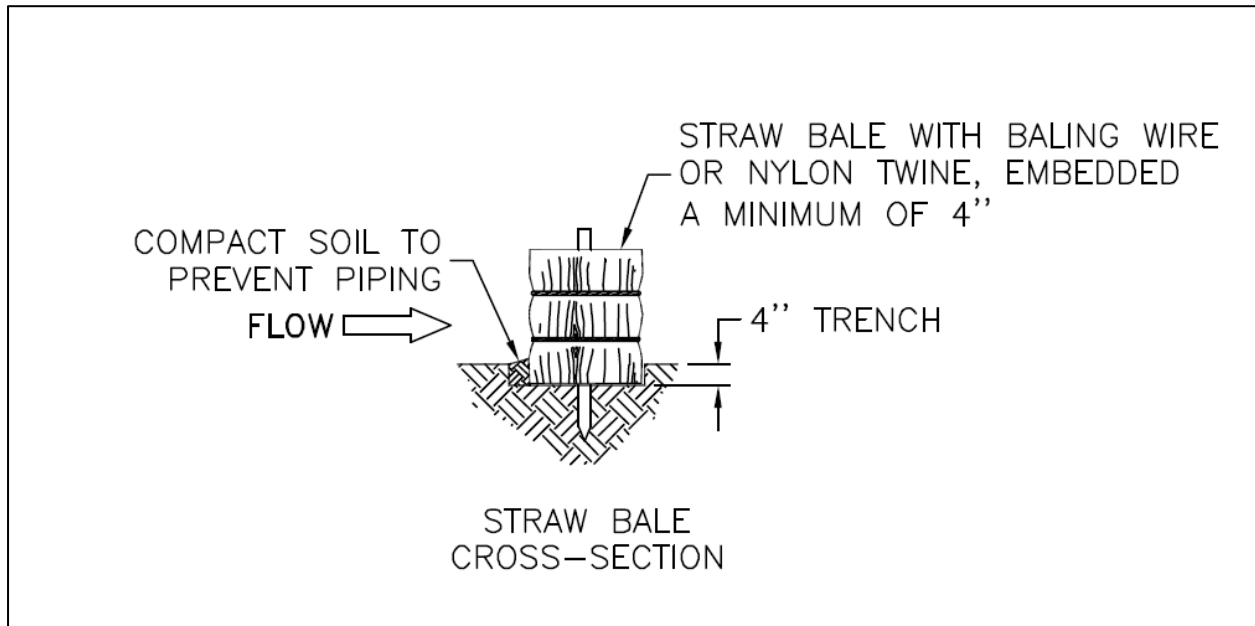

Figure CD-4 Typical Hay Bale Check Dam

(NOTE: Without proper installation, which is rarely done, hay bale check dams always fail.)

## Design Criteria and Installation

Formal design is not required. The following limiting factors should be adhered to when designing check dams.

### Drainage Area

Ten acres or less (rock or logs).

### Maximum Height

Two feet when drainage area is less than 5 acres.

Three feet when drainage area is 5 to 10 acres.

### Depth of Flow

Six inches when drainage area is less than 5 acres.

Twelve inches when drainage area is 5 to 10 acres.

The top of dam, perpendicular to flow, should be parabolic. The center of the dam should be constructed lower than the ends. The elevation of the center of the dam should be lower than the ends by the depth of flow listed above.

### Side Slopes

2:1 or flatter.

### Spacing

Elevation of the toe of the upstream dam is at or below elevation of the crest of the downstream dam.

## Keyway

The rock or log check dam should be keyed into the channel bottom and abutments to a depth of 12 to 24". The keyway width should be at least 12". The keyway is to prevent erosion around the end of and beneath the dam. Hay bale check dams should be embedded into the soil at least 3".

## Rock Check Dams

Rock check dams should be constructed of durable rock riprap. Rock material diameter should be 2" to 15".

In soils where failure by piping of soils into the rock is likely, a geotextile will be used as a filter to separate the soils from the rock. Geotextile should conform to the requirements of type I geotextile in Table CD-1.

Table CD-1 Requirements for Nonwoven Geotextile

Property	Test method	Class I	Class II	Class III	Class IV <sup>1</sup>
Tensile strength (lb) <sup>2</sup>	ASTM D 4632 grab test	180 minimum	120 minimum	90 minimum	115 minimum
Elongation at failure (%) <sup>2</sup>	ASTM D 4632	≥ 50	≥ 50	≥ 50	≥ 50
Puncture (pounds)	ASTM D 4833	80 minimum	60 minimum	40 minimum	40 minimum
Ultraviolet light (% residual tensile strength)	ASTM D 4355 150-hr exposure	70 minimum	70 minimum	70 minimum	70 minimum
Apparent opening size (AOS)	ASTM D 4751	As specified max. no.40 <sup>3</sup>	As specified max. no.40 <sup>3</sup>	As specified max. no.40 <sup>3</sup>	As specified max. no.40 <sup>3</sup>
Permittivity sec <sup>-1</sup>	ASTM D 4491	0.70 minimum	0.70 minimum	0.70 minimum	0.10 minimum

Table copied from NRCS Material Specification 592.

- 1 Heat-bonded or resin-bonded geotextile may be used for Classes III and IV. They are particularly well suited to Class IV. Needle-punched geotextile is required for all other classes.
- 2 Minimum average roll value (weakest principal direction).
- 3 U.S. standard sieve size.

### **Site Preparation**

Determine location of any underground utilities.

Locate and mark the site for each check dam in strategic locations (to avoid utilities and optimize effectiveness of each structure in flattening channel grade).

Remove debris and other unsuitable material that would interfere with proper placement of the check dam materials.

Excavate a shallow keyway (12"-24" deep and at least 12" wide) across the channel and into each abutment for each check dam.

### **Materials Installation**

As specified, install a non-woven geotextile fabric in the keyway in sandy or silty soils. This may not be required in clayey soils.

Construct the dam with a minimum 2:1 side slope over the keyway and securely embed the dam into the channel banks. Position rock to form a parabolic top, perpendicular to channel flow, with the center portion at the elevation shown in the design so that the flow goes over the structure and not around the structure.

### **Erosion and Sediment Control**

Install vegetation (temporary or permanent seeding) or mulching to stabilize other areas disturbed during the construction activities.

### **Construction Verification**

Check finished size, grade and shape for compliance with standard drawings and materials list (check for compliance with specifications if included in contract specifications).

### **Common Problems**

*Consult with a qualified design professional if any of the following occur:*

Variations in topography on site indicate check dam will not function as intended. Change in plan will be needed.

Materials specified in the plan are not available.

### **Maintenance**

Inspect the check dam for rock displacement and abutments for erosion around the ends of the dam after each significant rainfall event. If the rock appears too small, add additional stone and use a larger size.

Inspect the channel after each significant rainfall event. If channel erosion exceeds expectations, consult with the design professional and consider adding another check dam to reduce channel flow grade.

Sediment should be removed if it reaches a depth of ½ the original dam height. If the area behind the dam fills with sediment, there is a greater likelihood that water will flow around the end of the check dam and cause the practice to fail.

Check dams may be removed when their useful life has been completed. The area where check dams are removed should be seeded and mulched immediately unless a different treatment is prescribed. In some instances check dams should be left as a permanent measure to support channel stability.

## References

### BMPs from Volume 1

#### Chapter 4

Temporary Seeding (TS) 4-103

#### MDOT Drawing ECD-4

Ditch Check Structures, Typical Applications and Details 4-124

#### MDOT Drawing ECD-5

Temporary Erosion, Sediment and Water Pollution Control Measures, Silt Fence and Hay Bale Ditch Check 4-125

#### MDOT Drawing ECD-6

Details of Erosion Control Wattle Ditch Check 4-126

#### MDOT Drawing ECD-7

Details of Erosion Control Silt Dike Ditch Check 4-127

#### MDOT Drawing ECD-8

Rock Ditch Check 4-128

#### MDOT Drawing ECD-9

Rock Ditch Check with Sump Excavation 4-129

#### MDOT Drawing ECD-20

Details of Erosion Control Sandbag Ditch Check 4-130

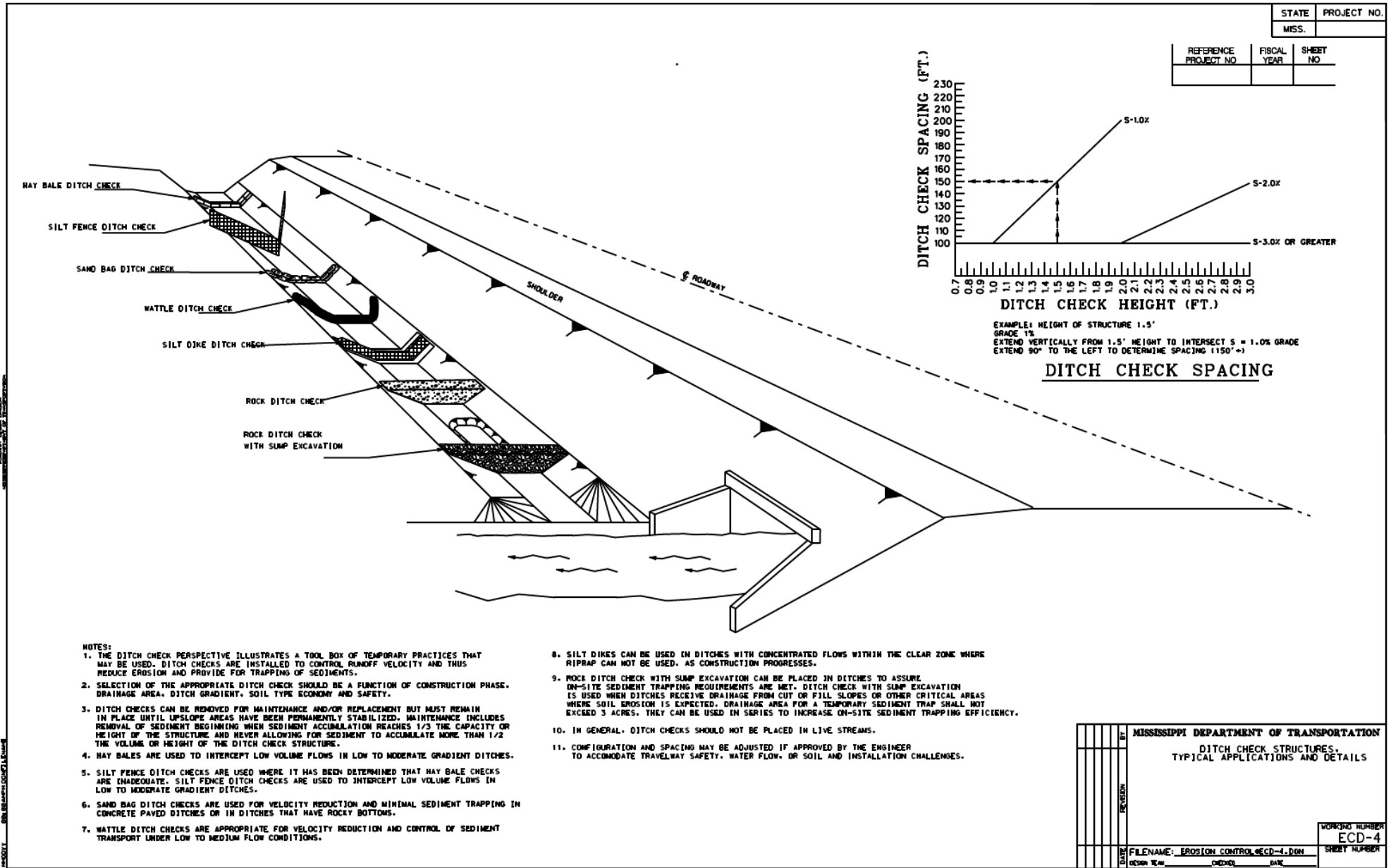

STATE	PROJECT NO.
MISS.	

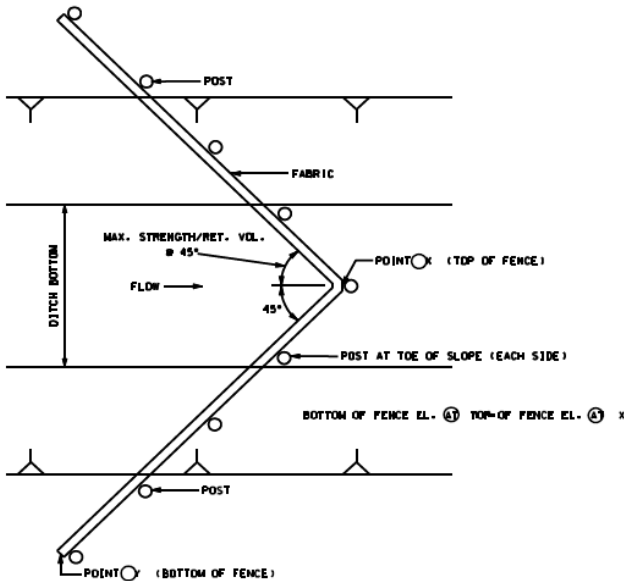

**PLAN VIEW**

- NOTES:
1. ANCHOR AND INSTALL PER DETAILS FOR SILT FENCE SPACING GUIDELINES ON ECD-4
  2. A "W" SHAPE MAY BE USED FOR WIDER DITCHES.

**SILT FENCE DITCH CHECK SELECTION GUIDELINES**

SILT FENCE DITCH CHECKS ARE USED WHERE IT HAS BEEN DETERMINED THAT HAY BALE CHECKS ARE INADEQUATE. SILT FENCE DITCH CHECKS ARE USED TO INTERCEPT LOW VOLUME FLOWS IN LOW TO MODERATE GRADIENT DITCHES.

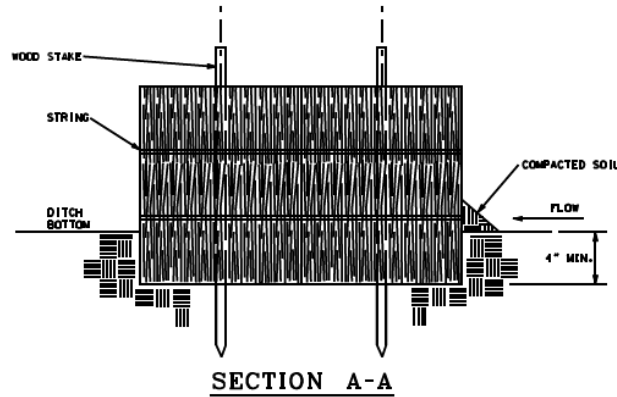

**SECTION A-A**

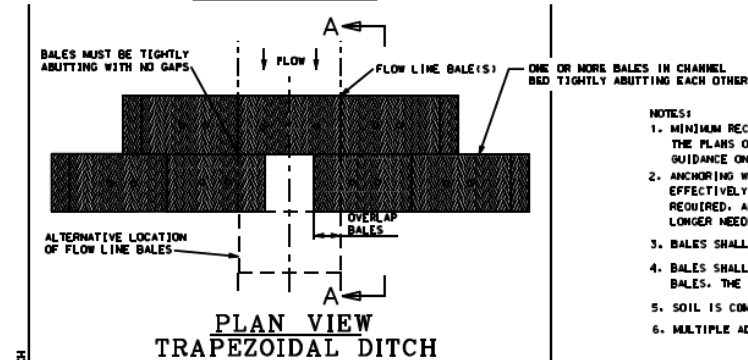

**PLAN VIEW  
TRAPEZOIDAL DITCH**

- NOTES:
1. MINIMUM RECOMMENDED CHECK SPACING IS 100 FEET UNLESS SHOWN OTHERWISE ON THE PLANS OR EROSION CONTROL PLAN APPROVED BY THE ENGINEER. SEE SPACING GUIDANCE ON ECD-4.
  2. ANCHORING WOOD STAKES SHALL BE SIZED, SPACED, AND BE OF A MATERIAL THAT EFFECTIVELY SECURES THE CHECK. A MINIMUM OF TWO STAKES PER BALE IS REQUIRED. ALL NON-DEGRADABLE MATERIALS SHALL BE REMOVED WHEN NO LONGER NEEDED.
  3. BALES SHALL BE EMBEDDED IN THE SOIL A MIN. OF 4".
  4. BALES SHALL BE PLACED IN A ROW WITH ENDS TIGHTLY ABUTTING THE ADJACENT BALES. THE BALES SHALL BE PLACED WITH BINDINGS PARALLEL TO THE GROUND.
  5. SOIL IS COMPACTED ALONG THE BASE OF THE UPSTREAM FACE TO PREVENT PIPING.
  6. MULTIPLE ADJACENT ROWS OF BALES ARE REQUIRED AS SHOWN.

**HAY BALE DITCH CHECK SELECTION GUIDELINES**

HAY BALES ARE USED TO INTERCEPT LOW VOLUME FLOWS IN LOW TO MODERATE GRADIENT DITCHES.

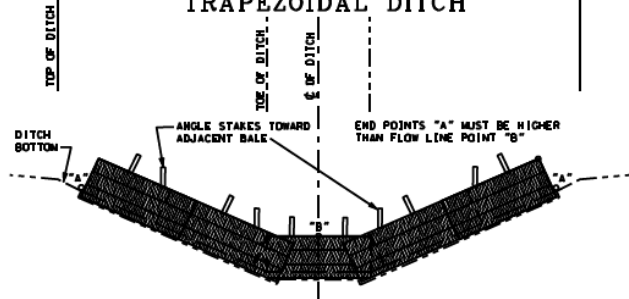

**PROFILE VIEW  
TRAPEZOIDAL DITCH**

DATE	BY	MISSISSIPPI DEPARTMENT OF TRANSPORTATION	
		TEMPORARY EROSION, SEDIMENT AND WATER POLLUTION CONTROL MEASURES - SILT FENCE AND HAY BALE DITCH CHECKS	
DESIGN TEAM	CHECKED	DATE	WORKING NUMBER ECD-5
FILENAME: EROSION_CONTROL/ECD-5.DGN	SHEET NUMBER		

STATE	PROJECT NO.
MSS.	

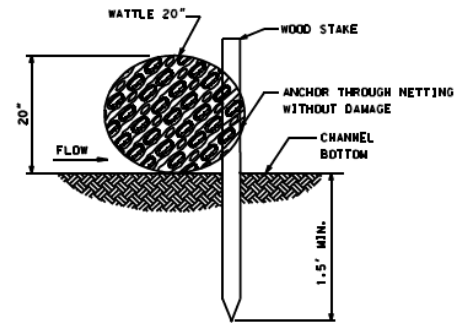
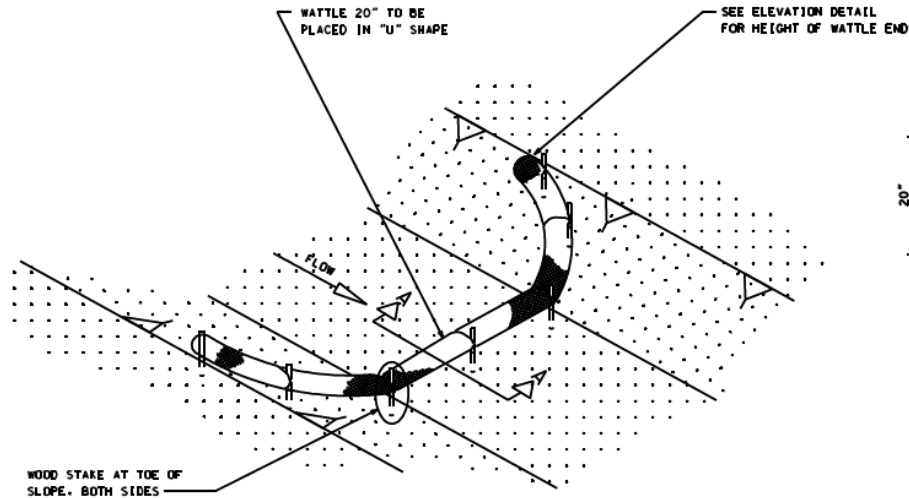

**SECTION A-A**

**DETAIL (DITCH CHECK)**

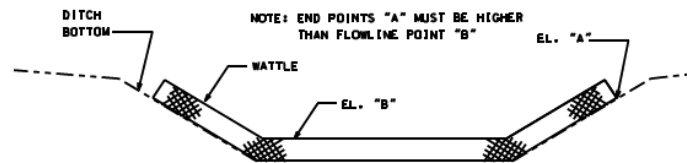

**ELEVATION DETAIL**

**NOTES:**

1. MINIMUM RECOMMENDED PLACEMENT INTERVAL BETWEEN WATTLE DITCH CHECK IS 100' UNLESS SHOWN OTHERWISE ON THE PLANS OR EROSION CONTROL PLAN APPROVED BY THE ENGINEER. SEE SPACING GUIDANCE ON ECD-4
2. ANCHORING WOOD STAKES SHALL BE SIZED, SPACED, DRIVEN, AND BE OF A MATERIAL THAT EFFECTIVELY SECURES THE CHECK. STAKE SPACING SHALL BE A MAXIMUM OF THREE FEET. ALL NON-DEGRADABLE MATERIALS SHALL BE REMOVED WHEN NO LONGER NEEDED.
3. TRENCHING OF WATTLES MAY BE NECESSARY IF PIPING BECOMES EVIDENT.
4. WATTLES SHOULD NOT BE USED IN HARD BOTTOM CHANNELS.

**WATTLE DITCH CHECK SELECTION GUIDELINES**

WATTLE DITCH CHECKS ARE APPROPRIATE FOR VELOCITY REDUCTION AND CONTROL OF SEDIMENT TRANSPORT UNDER LOW TO MEDIUM FLOW CONDITIONS.

BY		MISSISSIPPI DEPARTMENT OF TRANSPORTATION	
DATE		DETAILS OF EROSION CONTROL	
		WATTLE DITCH CHECK	
FILENAME:	EROSION_CONTROL-ECD-6.DGN	WORKING NUMBER	ECD-6
DESIGN TEAM:	CHECKED: JMT	SHEET NUMBER	

STATE	PROJECT NO.
MISS.	

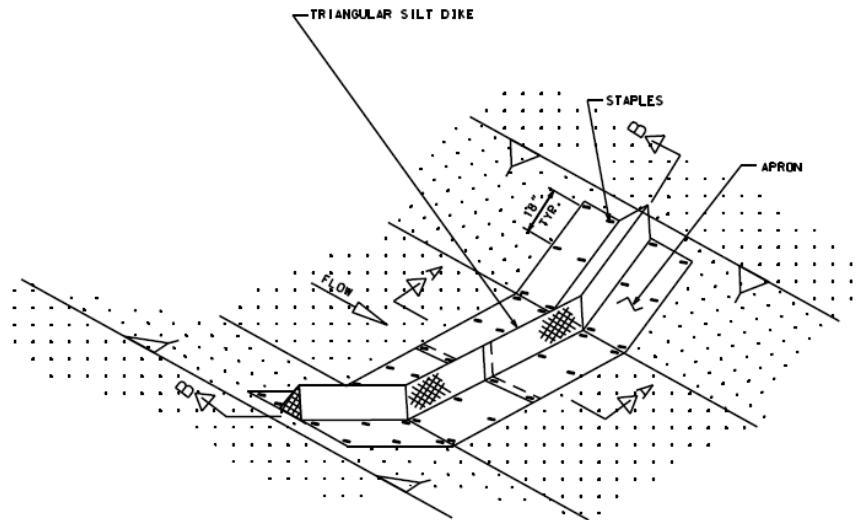

**SILT DIKE DITCH CHECK SELECTION GUIDELINES**

SILT DIKES CAN BE USED IN DITCHES WITH CONCENTRATED FLOWS WITHIN THE CLEAR ZONE WHERE RIPRAP CAN NOT BE USED.

**PLAN VIEW**

- NOTE:**
1. MINIMUM RECOMMENDED PLACEMENT INTERVAL BETWEEN SILT DIKE DITCH CHECK IS 100' UNLESS SHOWN OTHERWISE ON THE PLANS OR EROSION CONTROL PLAN APPROVED BY THE ENGINEER. SEE SPACING GUIDANCE ON ECD-4
  2. INSTALLATION SHALL BE IN ACCORDANCE WITH MANUFACTURERS RECOMMENDATIONS.

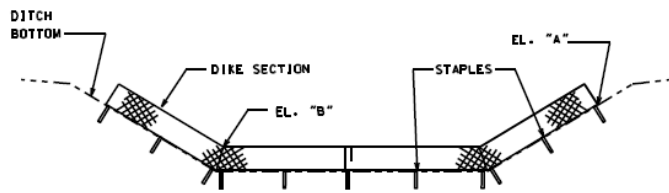

POINT "A" MUST BE HIGHER THAN POINT "B" TO ENSURE THAT WATER FLOWS OVER THE DIKE AND NOT AROUND THE ENDS

**SECTION B-B**

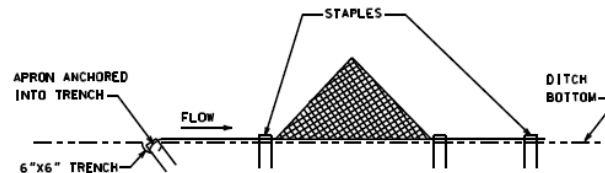

**NOTE:** STAPLES SHALL BE PLACED WHERE THE UNITS OVERLAP AND IN THE CENTER OF THE UNIT

**SECTION A-A**

**SILT DIKE INSTALLATION FOR ROADWAY DITCHES**

DATE	BY	MISSISSIPPI DEPARTMENT OF TRANSPORTATION
		DETAILS OF EROSION CONTROL SILT DIKE DITCH CHECK
FILENAME: _EROSION_CONTROL\ECD-7.DGN	WORKING NUMBER ECD-7	SHEET NUMBER
DESIGN TEAM	CHECKED	DATE

STATE	PROJECT NO.
MSS.	

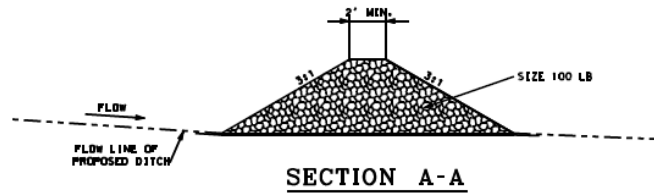
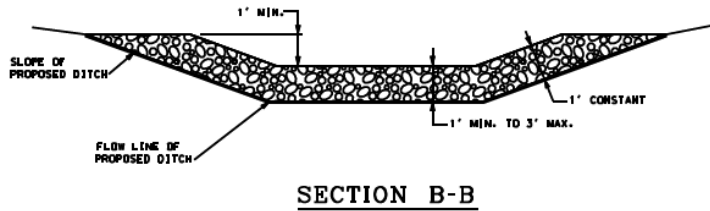
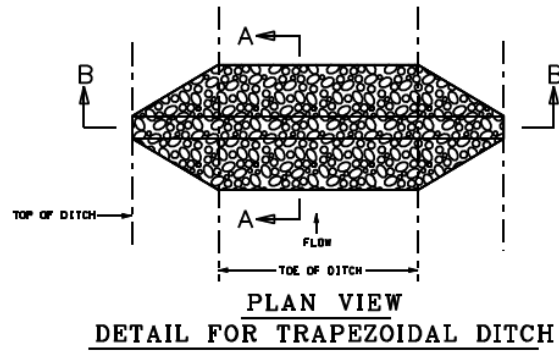

**TEMPORARY ROCK DITCH CHECKS IN ROADSIDE DITCHES**

- NOTES:**
1. MINIMUM SPACING FOR ROCK DITCH CHECKS SHALL BE 100 FEET OR EROSION CONTROL PLAN APPROVED BY THE ENGINEER. SEE SPACING GUIDANCE ON ECD-4
  2. ROCK DITCH CHECKS MAY ALSO BE CHECKED WITH FABRIC.
  3. SIZE 300 LB RIP RAP MAY BE USED FOR SPECIFIED APPLICATIONS AS SHOWN ON EROSION CONTROL PLAN

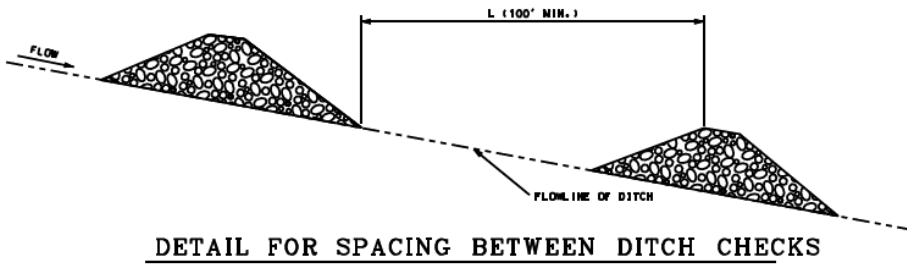

BY: MISSISSIPPI DEPARTMENT OF TRANSPORTATION	
ROCK DITCH CHECK	
DATE:	WORKING NUMBER: ECD-8
DESIGN TEAM:	PROJECT NUMBER:
CHECKED:	DATE:

STATE	PROJECT NO.
MISS.	

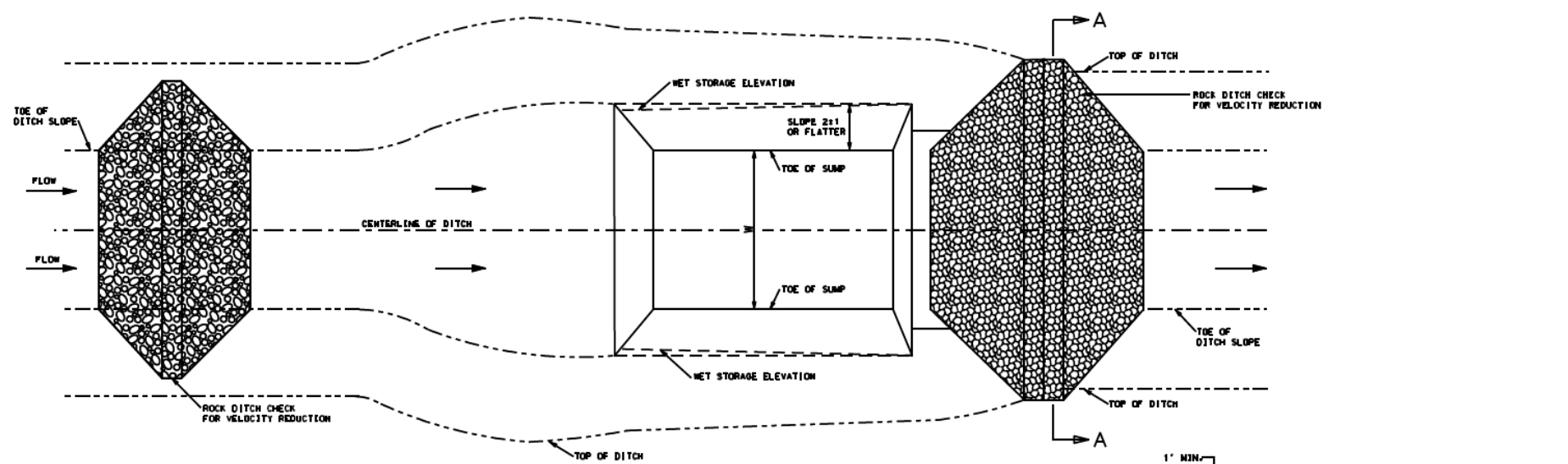

**PLAN VIEW**

**SECTION A-A**

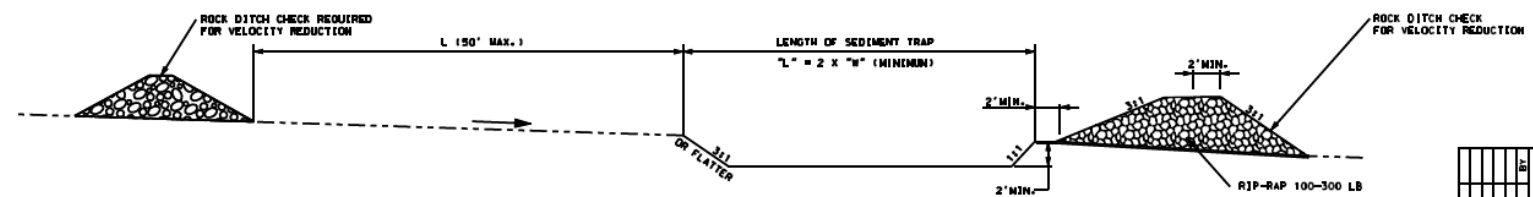

**PROFILE VIEW**

BY: MISSISSIPPI DEPARTMENT OF TRANSPORTATION	
ROCK DITCH CHECK WITH SUMP EXCAVATION	
DATE	WORKING NUMBER
DESIGN TEAM	ECD-9
CHECKED	SHEET NUMBER
DATE	
FILENAME: EROSION CONTROL #ECD-9.DGN	

STATE	PROJECT NO.
MISS.	

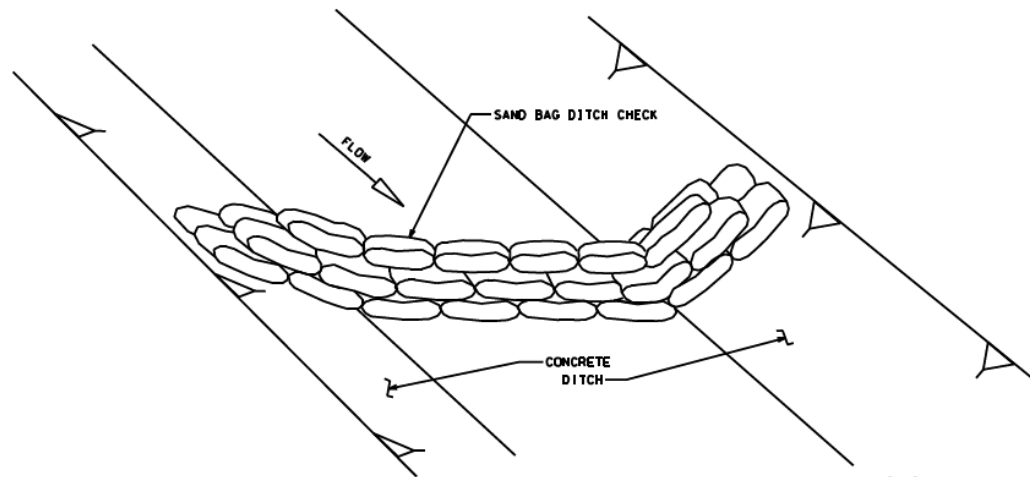

**DETAIL (DITCH CHECK)**

- NOTES:
1. MINIMUM RECOMMENDED PLACEMENT INTERVAL BETWEEN SAND BAG DITCH CHECK IS 100' UNLESS SHOWN OTHERWISE ON THE PLANS OR APPROVED BY THE ENGINEER. SEE SPACING GUIDANCE ON ECD-4.
  2. PREVENTING SEDIMENT FROM ENTERING A PAVED DITCH IS PREFERABLE TO CAPTURING SEDIMENT WITHIN PAVED DITCH.

**SAND BAG DITCH CHECK SELECTION GUIDELINES**

SAND BAG DITCH CHECKS ARE USED FOR VELOCITY REDUCTION AND MINIMAL SEDIMENT TRAPPING IN CONCRETE PAVED DITCHES OR IN DITCHES THAT HAVE ROCKY BOTTOMS.

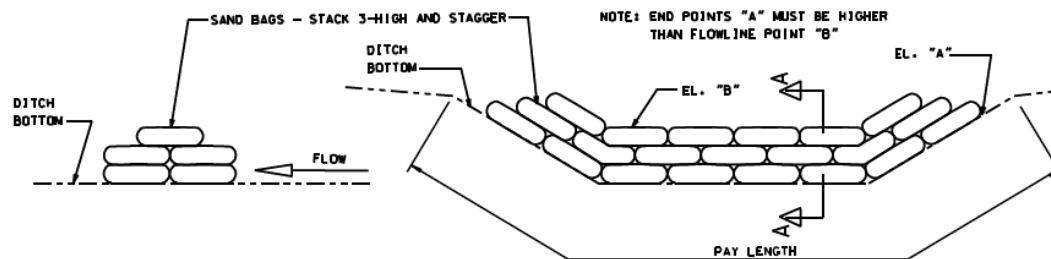

**SECTION A-A**

**ELEVATION DETAIL**

DATE	BY	MISSISSIPPI DEPARTMENT OF TRANSPORTATION
		DETAILS OF EROSION CONTROL
		SANDBAG DITCH CHECK
FILENAME:	DESIGN TEAM	CREATED DATE
WORKING NUMBER	ECD-20	
SHEET NUMBER		

## Outlet Protection (OP)

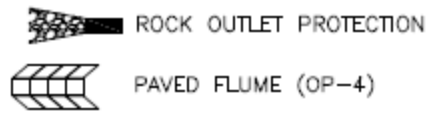

### Practice Description

This practice is designed to prevent erosion at the outlet of a channel or conduit by reducing the velocity of flow and dissipating the energy. Outlet protection measures usually consist of a riprap-lined apron, a reinforced concrete flume with concrete baffles, a reinforced concrete box with chambers or baffles, and possibly pre-manufactured products. This practice applies wherever high-velocity discharge must be released on erodible material.

### Planning Considerations

The outlets of pipes and structurally lined channels are points of critical erosion potential. Stormwater that is transported through man-made conveyance systems at design capacity generally reaches a velocity that exceeds the ability of the receiving channel or area to resist erosion. To prevent scour at stormwater outlets, a flow transition structure is required, which will absorb the initial impact of the flow and reduce the flow velocity to a level that will not erode the receiving channel or area of discharge.

The most commonly used structure for outlet protection is an erosion-resistant lined apron. These aprons are generally lined with loose rock riprap, grouted riprap, or concrete. They are constructed at zero grade for a distance that is related to the outlet flow rate and the tailwater level. Criteria for designing these structures are contained in this practice. Several outlet conditions are shown in Figure OP-1. Example design problems for outlet protection are found at the end of this practice.

Where the flow is excessive for the economical use of an apron, excavated stilling basins may be used. Acceptable designs for stilling basins may be found in the following documents available from the U.S. Government Printing Office.

- 1) Hydraulic Design of Energy Dissipaters for Culverts and Channels, Hydraulics Engineering Circular No.14, U.S. Department of Transportation, Federal Highway Administration.
- 2) Hydraulic Design of Stilling Basins and Energy Dissipaters, Engineering Monograph No. 25, U.S. Department of Interior-Bureau of Reclamation.

## Design Criteria and Construction

Structurally lined aprons at the outlets of pipes and paved channel sections should be designed according to the following criteria:

### Pipe Outlets

#### Capacity

The structurally lined apron should have the capacity to carry the peak stormflow from the 25-year 24-hour frequency storm, or the storm specified in state laws or local ordinances, or the design discharge of the water conveyance structure, whichever is greatest.

#### Tailwater

The depth of tailwater immediately below the pipe outlet must be determined for the design capacity of the pipe. Manning's Equation may be used to determine tailwater depth. Manning's Equation may be found in Appendix A: Erosion and Stormwater Runoff Calculations (available in the Appendices Volume). If the tailwater depth is less than half the diameter of the outlet pipe, it shall be classified as a Minimum Tailwater Condition. If the tailwater depth is greater than half the pipe diameter, it shall be classified as a Maximum Tailwater Condition. Pipes that outlet to flat areas, with no defined channel, may be assumed to have a Minimum Tailwater Condition.

#### Apron Length

The apron length should be determined from Figure OP-2 or OP-3 according to the tailwater condition.

#### Apron Thickness

The apron thickness should be determined by the maximum stone size ( $d_{max}$ ), when the apron is lined with riprap. The maximum stone size shall be  $1.5 \times d_{50}$  (median stone size), as determined from Figure OP-2 or OP-3. The apron thickness shall be  $1.5 \times d_{max}$ .

When the apron is lined with concrete, the minimum thickness of the concrete shall be 4".

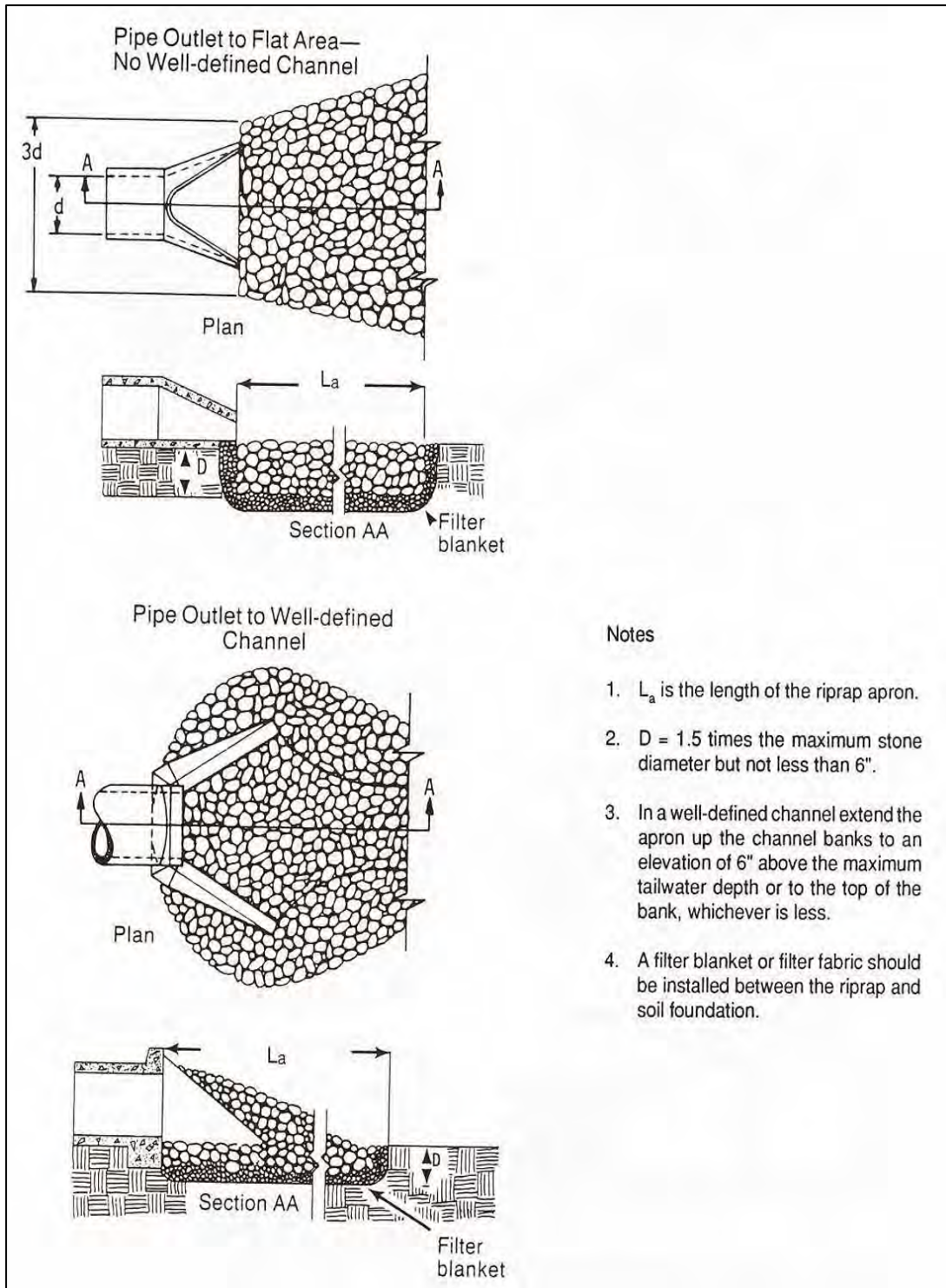

Notes

1.  $L_a$  is the length of the riprap apron.
2.  $D = 1.5$  times the maximum stone diameter but not less than 6".
3. In a well-defined channel extend the apron up the channel banks to an elevation of 6" above the maximum tailwater depth or to the top of the bank, whichever is less.
4. A filter blanket or filter fabric should be installed between the riprap and soil foundation.

Figure OP-1 Pipe Outlet Conditions

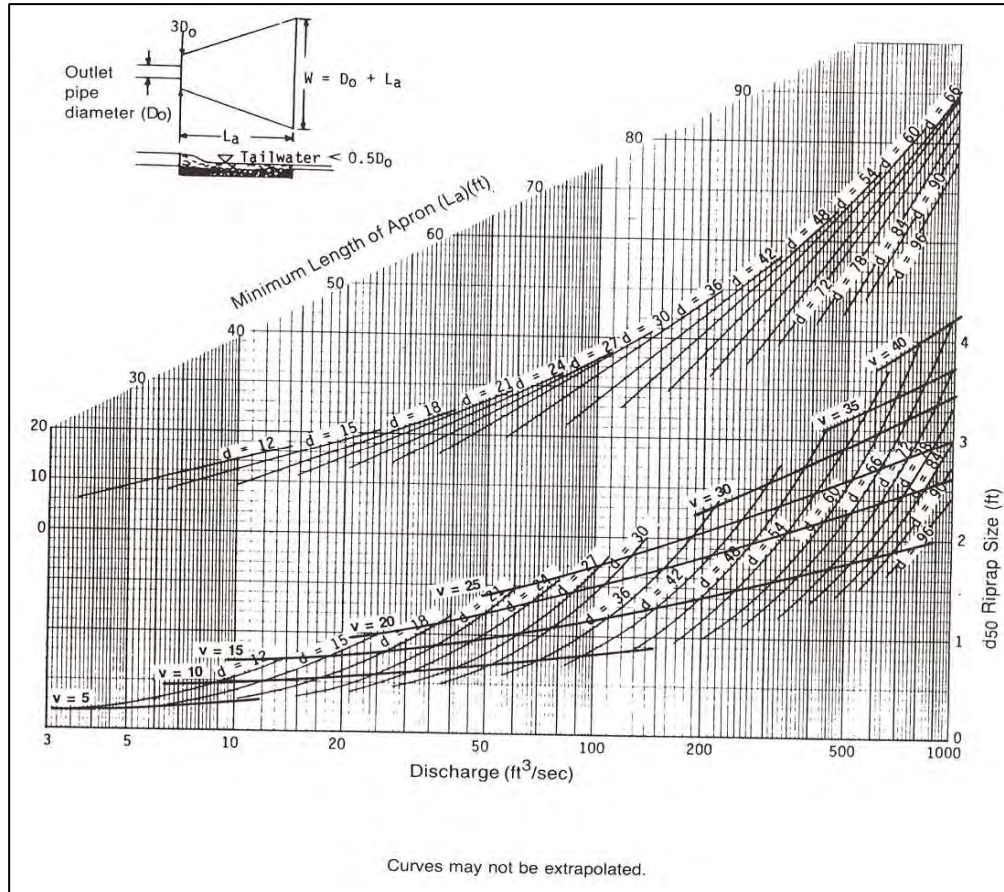

Figure OP-2 Outlet Protection Design for Tailwater  $< 0.5$  Diameter

### Apron Width

If the pipe discharges directly into a well-defined channel, the apron should extend across the channel bottom and up the channel banks to an elevation 1 foot above the maximum tailwater depth or to the top of the bank, whichever is the least.

If the pipe discharges onto a flat area with no defined channel, the width of the apron should be determined as follows:

- The upstream end of the apron, adjacent to the pipe, should have a width 3 times the diameter of the outlet pipe.
- For a Minimum Tailwater Condition, the downstream end of the apron should have a width equal to the pipe diameter plus the length of the apron obtained from the figures.
- For a Maximum Tailwater Condition, the downstream end shall have a width equal to the pipe diameter plus 0.4 times the length of the apron from Figure OP-2 or OP-3.

### Bottom Grade

The apron should be constructed with no slope along its length (0.0% grade). The invert elevation of the downstream end of the apron shall be equal to the elevation of the invert of the receiving channel. There shall be no overfall at the end of the apron.

### Side Slope

If the pipe discharges into a well-defined channel, the side slopes of the channel should not be steeper than 2:1 (Horizontal: Vertical).

### Alignment

The apron should be located so that there are no bends in the horizontal alignment.

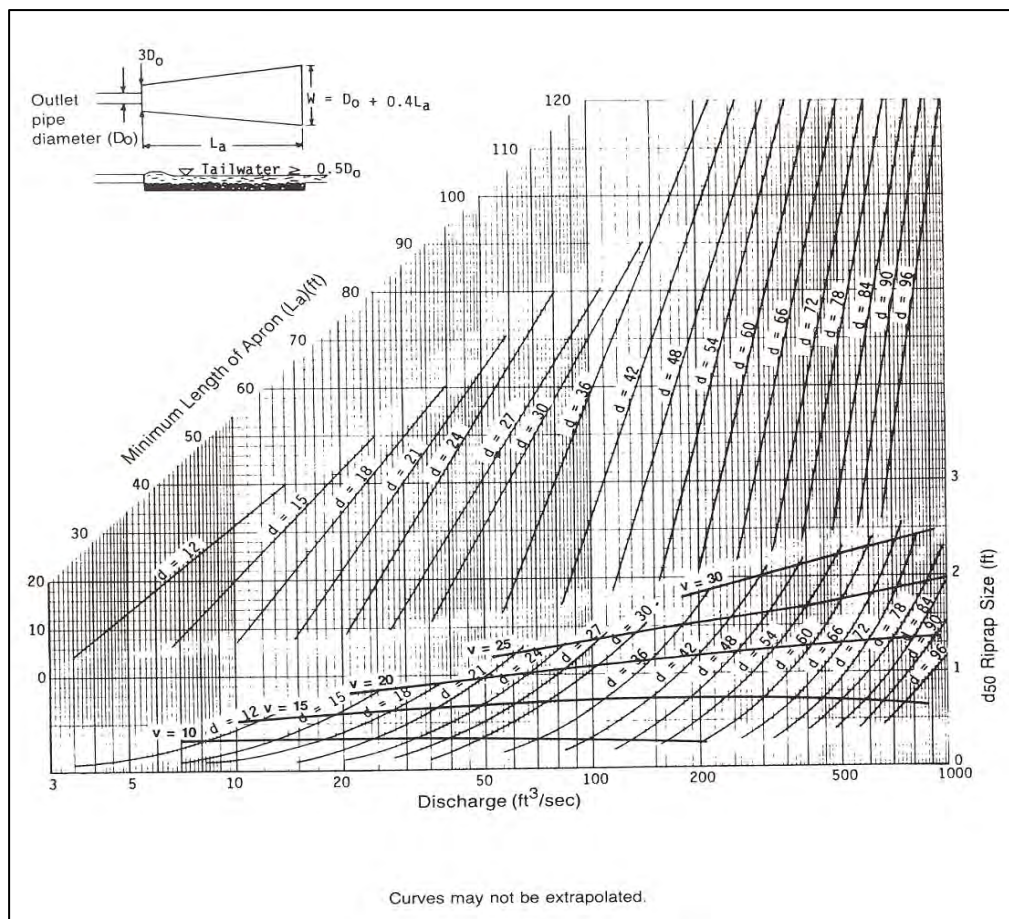

Figure OP-3 Outlet Protection Design for Tailwater  $\geq 0.5$  Diameter

### Geotextile

When riprap is used to line the apron, geotextile should be used as a separator between the graded stone, the soil subgrade, and the abutments. Geotextile should be placed immediately adjacent to the subgrade without any voids between the fabric and the subgrade. The geotextile will prevent the migration of soil particles from the subgrade

into the graded stone. The geotextile shall meet the requirements shown in the table below for Class I geotextile:

Table OP-1 Requirements for Nonwoven Geotextile

Property	Test method	Class I	Class II	Class III	Class IV <sup>1</sup>
Tensile strength (lb) <sup>2</sup>	ASTMD 4632 grab test	180 minimum	120 minimum	90 minimum	115 minimum
Elongation at failure (%) <sup>2</sup>	ASTMD 4632	≥ 50	≥ 50	≥ 50	≥ 50
Puncture (pounds)	ASTMD 4833	80 minimum	60 minimum	40 minimum	40 minimum
Ultraviolet light (% residual tensile strength)	ASTMD 4355 150-hr exposure	70 minimum	70 minimum	70 minimum	70 minimum
Apparent opening size (AOS)	ASTMD 4751	As specified max. no.40 <sup>3</sup>	As specified max. no.40 <sup>3</sup>	As specified max. no.40 <sup>3</sup>	As specified max. no.40 <sup>3</sup>
Permittivity sec <sup>-1</sup>	ASTMD 4491	0.70 minimum	0.70 minimum	0.70 minimum	0.10 minimum

Table copied from NRCS Material Specification 592.

- 1 Heat-bonded or resin-bonded geotextile may be used for Classes III and IV. They are particularly well suited to Class IV. Needle-punched geotextiles are required for all other classes.
- 2 Minimum average roll value (weakest principal direction).
- 3 U.S. standard sieve size.

## Materials

The apron may be lined with loose rock-riprap, grouted riprap, or concrete. The median-sized stone for riprap should be determined from the curves on Figures OP-2 and OP-3 according to the tailwater condition.

After the median stone size is determined, the gradation of rock to be used should be specified using Tables OP-2 and OP-3. Table OP-2 is used to determine the weight of the median stone size ( $d_{50}$ ). Using this median weight, a gradation can be selected from Table OP-3, which shows commercially available riprap gradations.

Stone for riprap should consist of field stone or rough unhewn quarry stone of approximately rectangular shape. The stone should be hard and angular and of such quality that it will not disintegrate on exposure to water or weathering; it shall be suitable in all other respects for the purpose intended. The specific gravity of the individual stones should be at least 2.5.

When the apron is lined with concrete, the concrete should have a minimum compressive strength at 28 days of 3000 pounds per square inch. American Concrete Institute

guidelines should be used to design concrete structures and reinforcement. As a minimum, the concrete should be reinforced with steel-welded wire fabric.

## **Construction**

Prior to start of construction, the practice should be designed by a qualified design professional. Plans and specifications should be referred to by field personnel throughout the construction process. The structure should conform to the dimensions, grades and alignments shown on the plans and specifications.

## **Site Preparation**

Completely remove stumps, roots, and other debris from the construction area. Fill depressions caused by clearing and grubbing operations with clean, non-organic soil. Grade the site to the lines and grades shown on the plans. Compact any fill required in the subgrade to the density of the surrounding undisturbed material.

If possible, the alignment should be straight throughout its length. If a curve is required, it should be located in the upstream section of the outlet.

## **Riprap Structures**

Ensure that the subgrade for the filter and riprap follows the required lines and grades shown in the plan. Low areas in the subgrade on undisturbed soil may also be filled by increasing the riprap thickness.

Geotextile fabric must meet design requirements and be properly protected from puncturing or tearing during installation. Repair any damage by removing the riprap and placing another piece of filter cloth over the damaged area. All connecting joints should overlap a minimum of 1.5 feet with the upstream edge over the downstream edge. If the damage is extensive, replace the entire geotextile fabric.

Riprap may be placed by equipment; however, care should be taken to avoid damaging the filter.

Construct the apron on zero grade with no overfall at the end. Make the top of the riprap at the downstream end level with the receiving area or slightly below it.

## **Concrete Structures**

Reinforcing steel-welded wire fabric should be placed in strict accordance with the design plans and maintained in the proper position during the pouring of concrete. Concrete should be placed in horizontal layers not exceeding 24" in thickness, or as specified in the design, and consolidated by mechanical vibrating equipment supplemented by hand-spading, rodding, or tamping.

Concrete should be placed in sturdy wood or metal forms, adequately supported to prevent deformation. Forms should be oiled prior to placement to prevent bonding between concrete and forms.

If possible, concrete should not be placed during inclement weather or periods of temperature extremes. If temperature extremes cannot be avoided, American Concrete Institute guidelines for placement of concrete during such extremes should be consulted.

Concrete should be allowed to cure as required by the plans and specifications.

Typically, the surface should be kept wet during curing by covering it with wet burlap sacks or other means. Design strengths should be confirmed by laboratory tests on representative cylinders made during concrete placement. Form work should not be removed prior to the specified time.

Table OP-2 Size of Riprap Stones

Weight	Mean Spherical Diameter (feet)	Rectangular Shape	
		Length	Width, Height (feet)
50	0.8	1.4	0.5
100	1.1	1.75	0.6
150	1.3	2.0	0.67
300	1.6	2.6	0.9
500	1.9	3.0	1.0
1000	2.2	3.7	1.25
1500	2.6	4.7	1.5
2000	2.75	5.4	1.8
4000	3.6	6.0	2.0
6000	4.0	6.9	2.3
8000	4.5	7.6	2.5
20000	6.1	10.0	3.3

Table OP-3 Graded Riprap

Class	Weight (lbs.)					
	d <sub>10</sub>	d <sub>15</sub>	d <sub>25</sub>	d <sub>50</sub>	d <sub>75</sub>	d <sub>90</sub>
1	10	-	-	50	-	100
2	10	-	-	80	-	200
3	-	25	-	200	-	500
4	-	-	50	500	1000	-
5	-	-	200	1000	-	2000

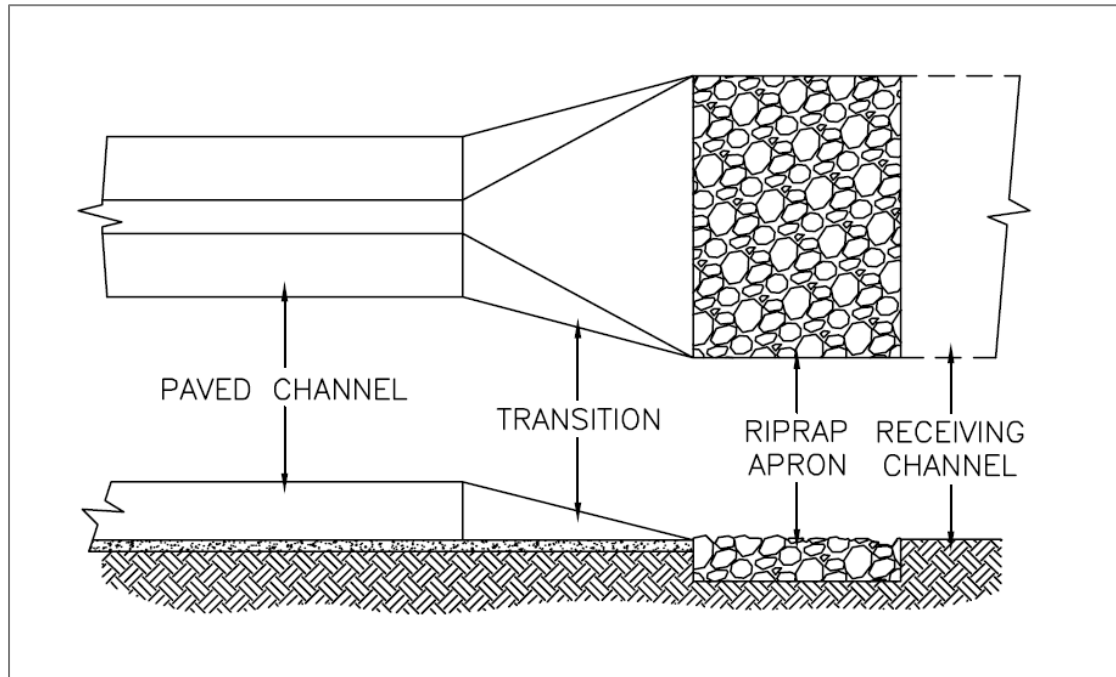

Figure OP-4 Paved Channel Outlet

- 1) The flow velocity at the outlet of paved channels flowing at design capacity should not exceed the velocity, which will cause erosion and instability in the receiving channel.
- 2) The end of the paved channel should merge smoothly with the receiving channel section. There should be no overfall at the end of the paved section. Where the bottom width of the paved channel is narrower than the bottom width of the receiving channel, a transition section should be provided. The maximum side divergence of the transition shall be 1 in 3F where

$$F = v/gd, \text{ and}$$

$$F = \text{Froude no.}$$

$$v = \text{Velocity at beginning of transition (ft/sec.)}$$

$$d = \text{Depth of flow at beginning of transition (feet.)}$$

$$g = 32.2 \text{ ft/sec.}^2$$

- 3) Bends or curves in the horizontal alignment of the transition are not allowed unless the Froude no. (F) is 0.8 or less, or the section is specifically designed for turbulent flow.

## Example Design Problems

### Example 1

Given: An 18" pipe discharges 24 cu. ft/sec at design capacity onto a grassy slope (no defined channel).

Find: The required length, width and median stone size ( $d_{50}$ ) for a riprap-lined apron.

### Solution

Since the pipe discharges onto a grassy slope with no defined channel, a Minimum Tailwater Condition may be assumed.

From Figure OP-2, an apron length ( $L_a$ ) of 20 feet and a median stone size ( $d_{50}$ ) of 0.8 foot is determined.

The upstream apron width equals 3 times the pipe diameter:  $3 \times 1.5 \text{ feet} = \underline{4.5 \text{ feet}}$ .

The downstream apron width equals the apron length plus the pipe diameter:  
 $20 \text{ feet} + 1.5 \text{ foot} = \underline{21.5 \text{ feet}}$ .

### Example 2

Given: The pipe in example No. 1 discharges into a channel with a triangular cross section, 2 feet deep and 2:1 side slopes. The channel has a 2% slope and an "n" coefficient of 0.045.

Find: The required length, width and the median stone size ( $d_{50}$ ) for a riprap lining.

### Solution

Determine the tailwater depth using Manning's Equation and the Continuity Equation.

$$Q = 1.49/n R^{2/3} S^{1/2} A$$

$$24 = 1.49/n [2d/4.47]^{2/3} (0.02)^{1/2} (2d^2)$$

where,  $d$  = depth of tailwater  
 $d = 1.74 \text{ feet}^*$

\*Since  $d$  is greater than half the pipe diameter, a Maximum Tailwater Condition exists.

From Figure OP-3, a median stone size ( $d_{50}$ ) of 0.5 foot and an apron length ( $L_a$ ) of 41 feet is determined.

The entire channel cross section should be lined, since the maximum tailwater depth is within 1 foot of the top of the channel.

### **Construction Verification**

Check finished structures for conformance with design specifications.

### **Common Problems**

*Consult with a qualified design professional if any of the following occur:*

Variations in topography on site indicate measure will not function as intended.

Design specifications for riprap, filter fabric, concrete, reinforcing steel, or backfill cannot be met; substitutions may be required. Unapproved substitutions could lead to failure.

Problems with the structure develop during or after installation.

### **Maintenance**

Inspect riprap outlet structures after heavy rains to see if any erosion around or below the riprap has taken place or if stones have been dislodged. Check concrete structures for cracks and movement. Immediately make all needed repairs to prevent further damage.

### **References**

#### **BMPs from Volume 1**

##### **Chapter 4**

Grass Swale (GS)

4-162

## Brush/Fabric Barrier (BFB)



### Practice Description

A brush/fabric barrier is a dam-like structure constructed from woody residue and faced with a geotextile fabric to provide a temporary sediment basin. This practice is applicable on sites with a small drainage area where brush and other woody debris are available from a clearing and grubbing operation.

### Planning Considerations

This practice is intended to be a temporary sediment basin with a limited life span and applicable only for small drainage areas.

The barrier should be located downslope from areas with potential sheet and rill erosion, with adequate storage volume in front of the barrier, and with no more than 2 acres of drainage area.

Adequate woody material from clearing and grubbing required on the site must be available for the construction of the barrier.

The practice should be located and designed so that adequate storage volume and detention time can be obtained, and failure of the barrier will not result in hazard to the public or damage to work on either on-site or off-site property.

### Design Criteria and Construction

Prior to start of construction, a qualified design professional should determine the location and storage for the barrier. Typically, brush/fabric barriers are constructed where materials are readily available and at a location with adequate storage characteristics.

### Drainage Area

Brush/fabric barriers should be designed with no more than 2 acres of drainage area. A sediment basin should be considered for larger drainage areas (see *Sediment Basin Practice*).

### Structure Life

The design life of the structure should be 1 year or less. The barrier should be removed, and sediment accumulations properly stabilized prior to completion of the construction project.

### Sediment Storage

The barrier should be designed to provide 67 cubic yards of sediment storage per acre of disturbed drainage area. Sediment should be removed and properly utilized on-site when half of the sediment storage volume has been filled.

### Site Location and Preparation

The site for the barrier should be located so that a basin capable of providing the sediment storage required can be obtained or created. The site for the barrier should be smoothed prior to placement of the brush.

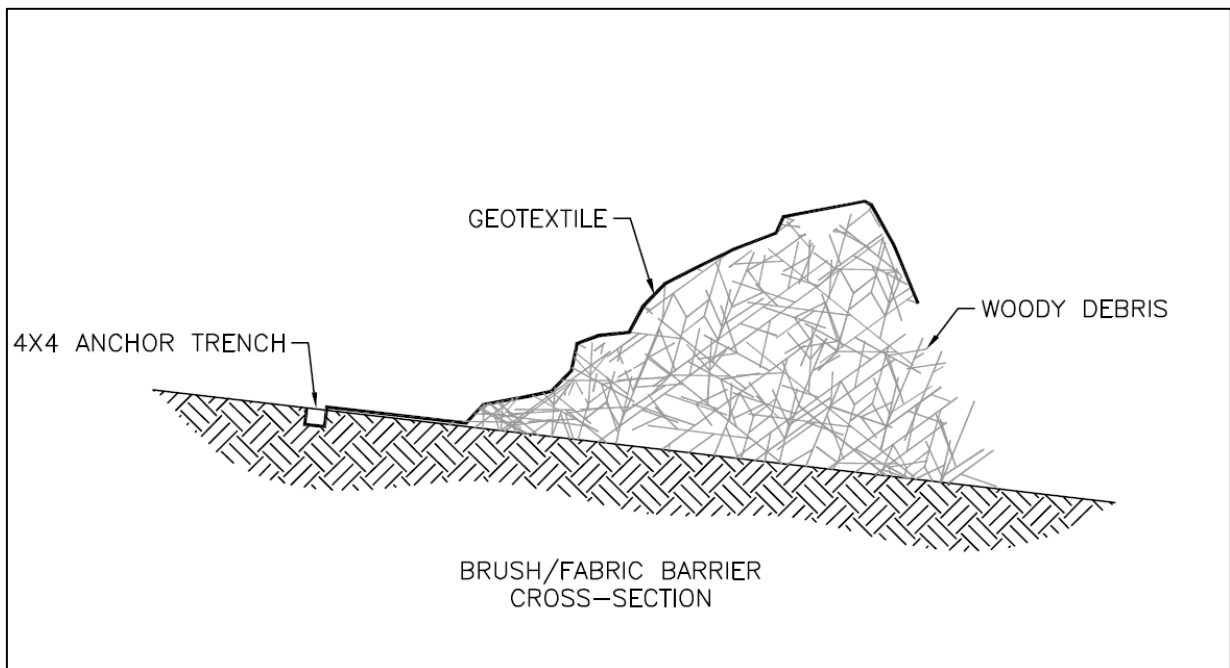

Figure BFB-1 Typical Installation

### Materials Installation

Place the cleared and grubbed material in a densely compacted row, mostly on the contour, with each end upturned so that excessive flows will go over the top of the barrier and not around the ends of the barrier. Figure BFB-1 shows the typical installation.

Densely packed material should be placed so that the main stems of the woody debris are aligned with the length of the barrier. Small stems and limbs protruding from the bundle that could damage the fabric should be trimmed.

Generally, the barrier should be at least 3 feet tall, but no more than 6 feet tall. The width of the barrier perpendicular to the direction of flow should be at least 5 feet at its base.

Geotextile filter fabric consistent with the fabric used for silt fencing can be used to cover the face of the barrier. It is best to use wide and long rolls of the fabric so that splicing is minimized or eliminated. The fabric used to face the upstream surface of the brush should be non-woven geotextile equivalent to Class II fabric (see Table BFB-1).

The fabric should be securely buried at the bottom of an excavated trench that is at least 6" deep in front of the barrier. Prior to backfilling the trench, the fabric should be securely staked at 3-foot centers with minimum 18" long wooden stakes.

The fabric to be used should be supplied in lengths and widths to minimize vertical splices and eliminate horizontal splices. Avoid longitudinal splices of the fabric. Vertical splices must be securely fastened to each other so that flows will not short-circuit through the splice. The minimum vertical splice overlap should be 3 feet. Vertical splices must be securely fastened to each other so that flows will not short-circuit through the splice.

The top edge of the fabric should be secured so that it will not sag below the designed storage elevation. The upper edge can be anchored with twine fastened to the fabric and secured to stakes behind the barrier.

Table BFB-1 Requirements for Nonwoven Geotextile

Property	Test method	Class I	Class II	Class III	Class IV <sup>1</sup>
Tensile strength (lb) <sup>2</sup>	ASTMD 4632 grab test	180 minimum	120 minimum	90 minimum	115 minimum
Elongation at failure (%) <sup>2</sup>	ASTMD 4632	≥50	≥50	≥50	≥50
Puncture (pounds)	ASTMD 4833	80 minimum	60 minimum	40 minimum	40 minimum
Ultraviolet light (% residual tensile strength)	ASTMD 4355 150-hr exposure	70 minimum	70 minimum	70 minimum	70 minimum
Apparent opening size (AOS)	ASTMD 4751	As specified max. no. 40 <sup>3</sup>	As specified max. no. 40 <sup>3</sup>	As specified max. no. 40 <sup>3</sup>	As specified max. no. 40 <sup>2</sup>
Permittivity sec <sup>-1</sup>	ASTMD 4491	0.70 minimum	0.70 minimum	0.70 minimum	0.10 minimum

Table copied from NRCS Material Specification 592.

<sup>1</sup> Heat-bonded or resin-bonded geotextiles may be used for Classes III and IV. They are particularly well suited to Class IV. Needle-punched geotextile is required for all other classes.

<sup>2</sup> Minimum average roll value (weakest principal direction).

<sup>3</sup> U.S. standard sieve size.

## Construction Verification

Check finished size, elevation, storage, and shape for compliance with standard drawings and materials list. (Check for compliance with specifications if included in contract specifications.)

## Common Problems

*Consult with a qualified design professional if any of the following occurs:*

Variations in topography on-site indicate brush/fabric barrier will not function as intended. Change in design plan will be needed.

There is not adequate cleared, woody material to construct the barrier.

Materials specified in the plan are not available.

## Maintenance

Inspect the barrier for short-circuiting of water or flow around the ends of the barrier after each significant rainfall event.

Sediment should be removed if it reaches a depth half of the original fabric height. If the area behind the barrier fills with sediment, there is a greater likelihood that water will flow around the end of the barrier and cause the practice to fail.

Large rainfall events that overtop the structure can result in gully erosion behind the barrier. This should be repaired as needed.

Brush/fabric barriers are temporary structures and should be removed when their useful life has been completed. All accumulated sediment should be properly stabilized, and the area where the barrier was located should be seeded and mulched immediately unless a different treatment is prescribed.

## References

### BMPs from Volume 1

#### Chapter 4

Sediment Basin (SBN) 4-298

#### MDOT Drawing ECD-2

Details of Sediment Barrier Applications 4-259

#### MDOT Drawing TEC-1

Typical Temporary Erosion Control Measures 4-260

STATE	PROJECT NO.
MSS.	

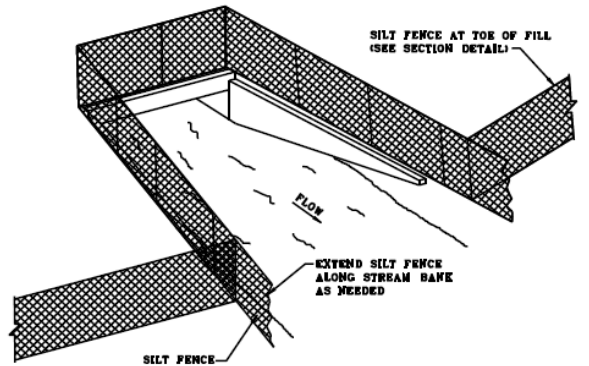

**SEDIMENT BARRIER AT CROSS DRAIN**

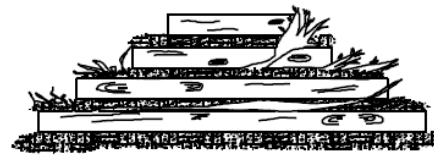

**FRONT ELEVATION**

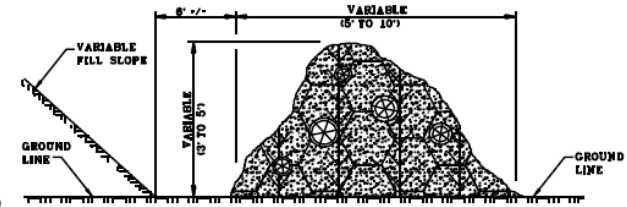

**SIDE ELEVATION**

**TEMPORARY BRUSH BARRIER**

- NOTES:
1. BRUSH BARRIER MAY BE USED WHERE NATURAL GROUND IS LEVEL OR SLOPING AWAY FROM PROJECT.
  2. PLACE BRUSH LOG AND TREE LAPS APPROXIMATELY PARALLEL TO TOE OF FILL SLOPE WITH SOME OF THE HEAVIER MATERIALS BEING PLACED ON TOP TO PROPERLY SECURE THE BARRIER AS DETAILED AT LOCATIONS SHOWN ON PLANS OR AS DIRECTED OR PERMITTED BY THE ENGINEER.
  3. TO ALLOW WATER TO SEEP THROUGH BRUSH BARRIER, INTERMINGLE THE BRUSH LOG AND TREE LAPS SO AS NOT TO FORM A SOLID DAM.
  4. THE BRUSH BARRIER MAY BE CHOKED WITH FILTER FABRIC.
  5. TEMPORARY BRUSH BARRIER WILL NOT BE MEASURED FOR SEPARATE PAYMENT.

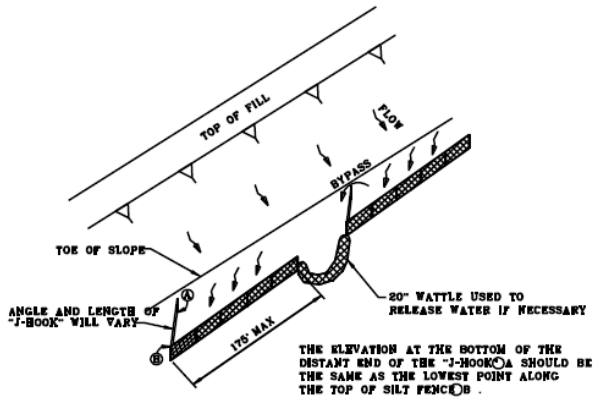

**"J-HOOK" SILT FENCE APPLICATION**

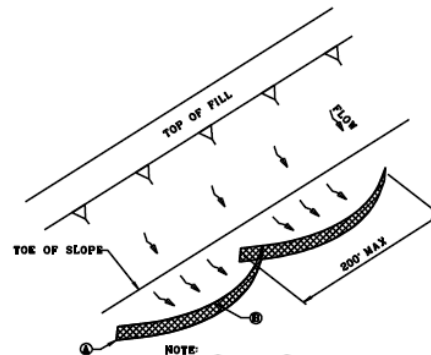

**"SMILE-CONFIGURATION" SILT FENCE APPLICATION**

- NOTE:
1. ANCHOR AND INSTALL SILT FENCE PER DETAILS SHOWN ON ECD-3

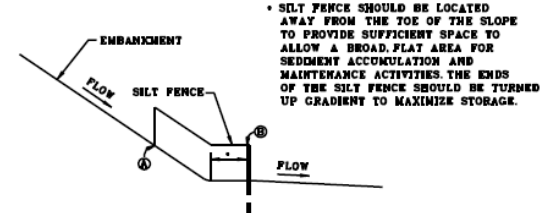

**SILT FENCE SECTION AT TOE OF FILL**

MISSISSIPPI DEPARTMENT OF TRANSPORTATION	
DETAILS OF SEDIMENT BARRIER APPLICATIONS	
WORKING NUMBER	ECD-2
FILENAME: EROSION CONTROL\ECD-2.DGN	SHEET NUMBER
DESIGN TEAM	CHECKED DATE

STATE	PROJECT NO.
MISS.	

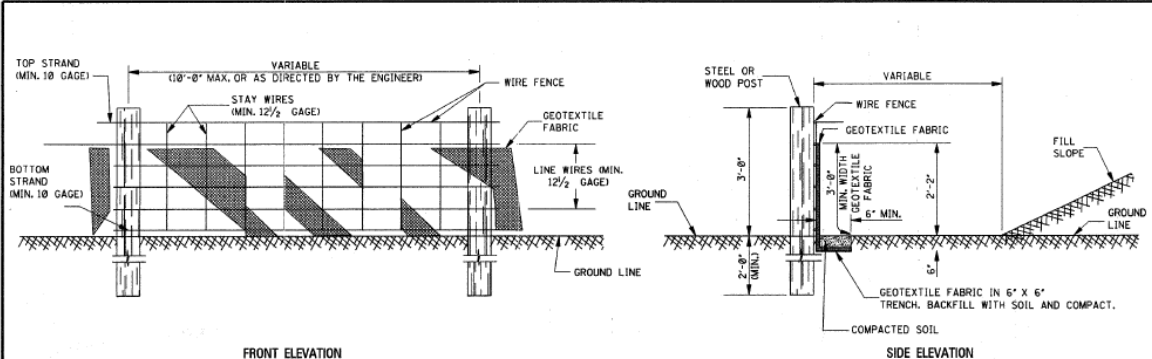

FRONT ELEVATION

SIDE ELEVATION

**TEMPORARY SILT FENCE**

- NOTES:
1. WIRE SHALL BE MINIMUM OF 32" IN WIDTH AND SHALL HAVE A MINIMUM OF 6 LINE WIRES WITH 12" STAY SPACING.
  2. GEOTEXTILE FABRIC SHALL BE A MINIMUM OF 36" IN WIDTH AND SHALL BE FASTENED ADEQUATELY TO THE WIRE AS DIRECTED BY THE ENGINEER.
  3. STEEL POST SHALL BE 5'-0" IN HEIGHT AND OF THE SELF-FASTENER ANGLE STEEL TYPE. WOOD POST SHALL BE A MINIMUM OF 3'-0" IN HEIGHT AND 3" OR MORE IN DIAMETER. WIRE FENCE SHALL BE FASTENED TO WOODEN POST WITH NOT LESS THAN 9 GAGE WIRE STAPLES 1' LONG.
  4. GEOTEXTILE FABRIC MEETING THE TYPE II MATERIAL REQUIREMENTS AND INSTALLED ACCORDING TO SPECIFICATIONS MAY BE USED WITHOUT WIRE FENCE.

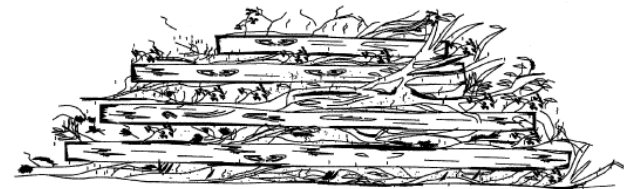

FRONT ELEVATION

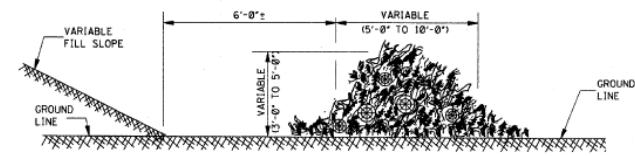

SIDE ELEVATION

**TEMPORARY BRUSH BARRIER**

- NOTES:
1. BRUSH BARRIER TO BE USED WHERE NATURAL GROUND IS LEVEL OR SLOPING AWAY FROM PROJECT.
  2. PLACE BRUSH, LOG AND TREE LAPS APPROXIMATELY PARALLEL TO TOE OF FILL SLOPE WITH SOME OF THE HEAVIER MATERIALS BEING PLACED ON TOP TO PROPERLY SECURE THE BARRIER AS DETAILED AT LOCATIONS SHOWN ON PLANS OR AS DIRECTED BY THE ENGINEER.
  3. TO ALLOW WATER TO FLOW THROUGH BRUSH BARRIER, INTERMINGLE THE BRUSH, LOG AND TREE LAPS SO AS NOT TO FORM A SOLID DAM.

GENERAL NOTES:

1. THE CONTRACTOR SHALL BE REQUIRED TO FURNISH ALL MATERIALS AND PERFORM ALL WORK FOR THE PROPER INSTALLATION, MAINTENANCE AND REMOVAL OF TEMPORARY EROSION CONTROL MEASURES NECESSARY TO CONTROL SILTATION.
2. TEMPORARY BRUSH BARRIERS SHALL BE USED AS REQUIRED BUT WILL NOT BE MEASURED FOR SEPARATE PAYMENT.
3. THE USE OF TEMPORARY EROSION CONTROL MEASURES OTHER THAN TEMPORARY BRUSH BARRIERS WILL ONLY BE REQUIRED AND MEASURED FOR SEPARATE PAYMENT WHEN APPROPRIATE PAY ITEM(S) IS INCLUDED IN THE BID SCHEDULE OF THE PROPOSAL.

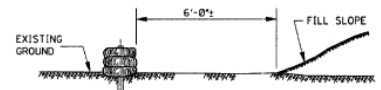

ELEVATION

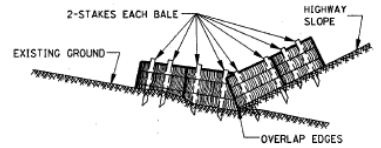

ELEVATION

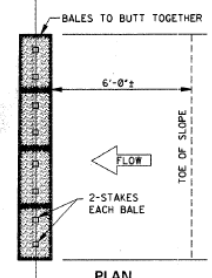

PLAN

FALL OF DITCH (ft)	DISTANCE* (ft)
0 - 1	100'
1 - 2	50'
>2	25'

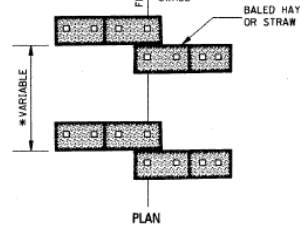

PLAN

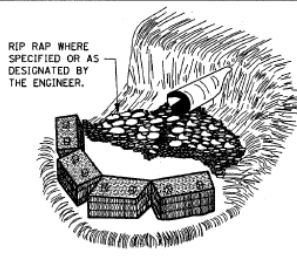

CULVERT

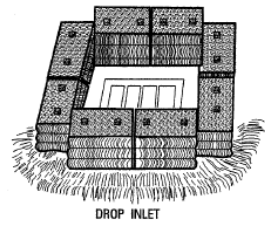

DROP INLET

**TEMPORARY EROSION CHECKS USING HAY OR STRAW BALES**

NOTE: EMBED ALL BALES 3" MINIMUM INTO GROUND AND STAKE (2" X 2" X 36") SECURELY.

MISSISSIPPI DEPARTMENT OF TRANSPORTATION ROADWAY DESIGN DIVISION STANDARD PLAN	
<b>TYPICAL TEMPORARY EROSION CONTROL MEASURES</b> (SILT FENCE, HAY BALES & BRUSH BARRIER)	
WORKING NUMBER TEC-1	 SHEET NUMBER 142
ISSUE DATE: OCTOBER 1, 1998	