

Proposed shop drawings for

Terrell Mint Dentistry

Default

Finishes	
Code	Finish
PL1	Wilsonart 4168-60 Grey Pampas
PL2	Wilsonart 7995-60 Sterling Ash

****note-all dimensions to be field verified prior to fabrication**

Sheet No.:
Sheet 1

Drawn By:
Scott Marrs
Date:
08/03/19

Terrell Mint Dentistry
SHEET TITLE:
Cover Sheet

AEP
MILLWORK
CUSTOM CABINETS + COUNTERTOPS
817.522.4542



Business Office	
Item	Finish
Cabinet	RT 2
Countertop	RT 1
Transition Top	Stone by other

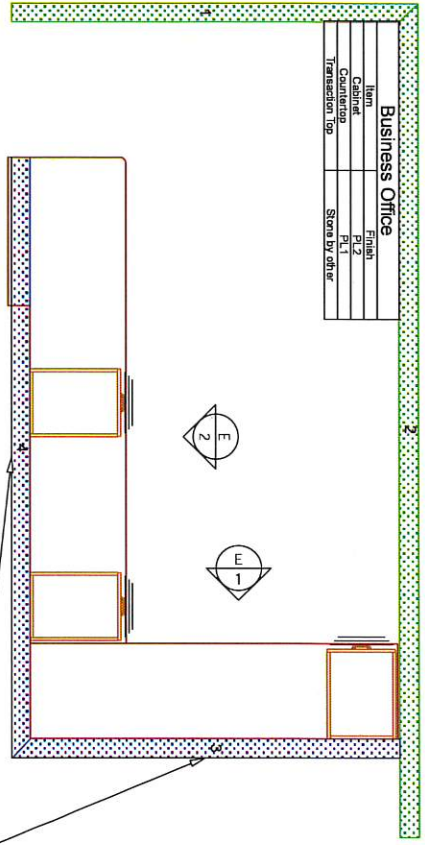

Wall to be skinned with WA 7395-50

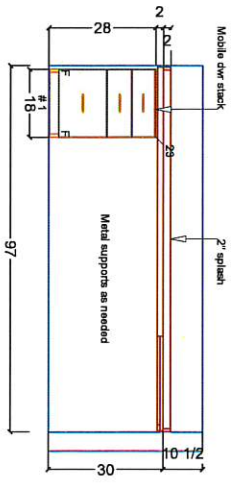

Business Office
Scale: 3/8" = 1'

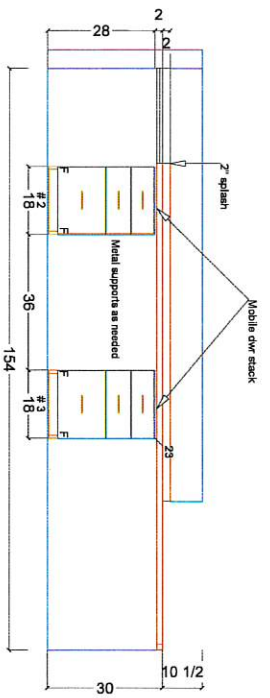

Business Office
Scale: 3/8" = 1'

Sheet No.:
Sheet 2

Drawn By:
Scott Marrs
Date:
06/03/19

Terrell Mint Dentistry
SHEET TITLE:
Business Office

AEP MILLWORK
CUSTOM CABINETS + COUNTERTOPS
817.522.4542

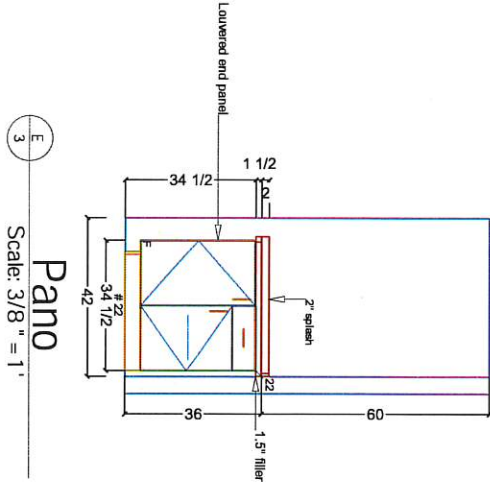
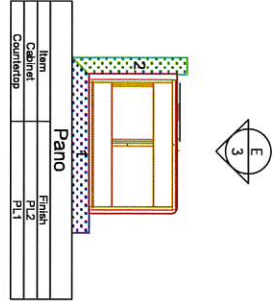

3

Pano

Scale: 3/8" = 1'

Item	Finish
Business Manager	P.L.
Cabinet	P.L.
Countertop	P.L.

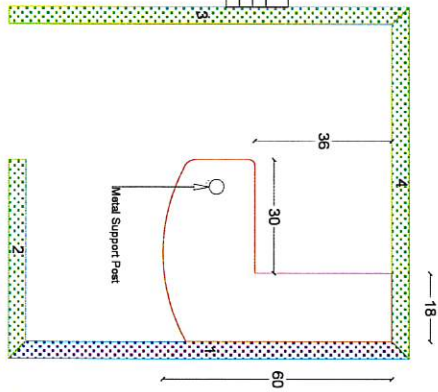

Sheet No.:
Sheet 3

Drawn By:
Scott Marrs
Date:
06/03/19

Terrell Mint Dentistry

SHEET TITLE:

Pano, Business Manager

AEP
MILLWORK
CUSTOM CABINETS + COUNTERTOPS

817.522.4542

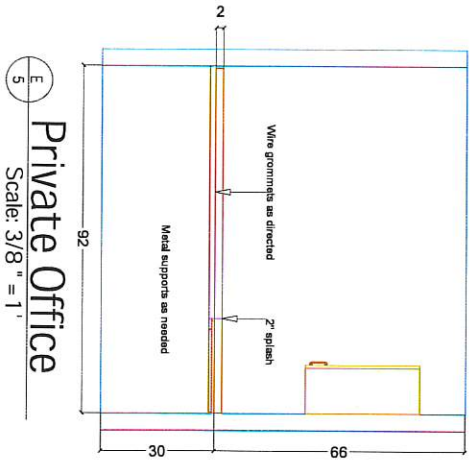
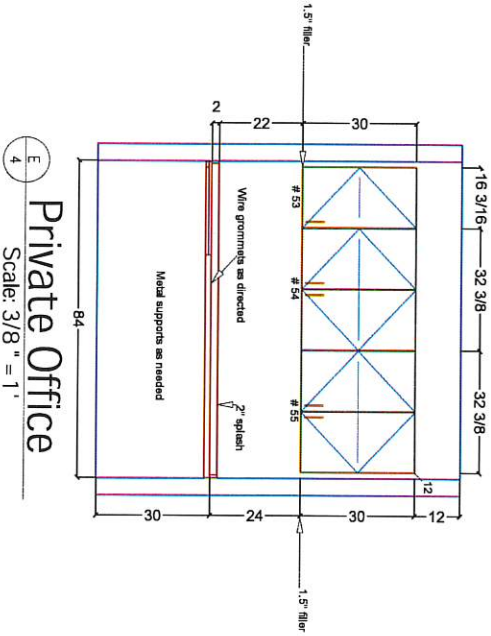
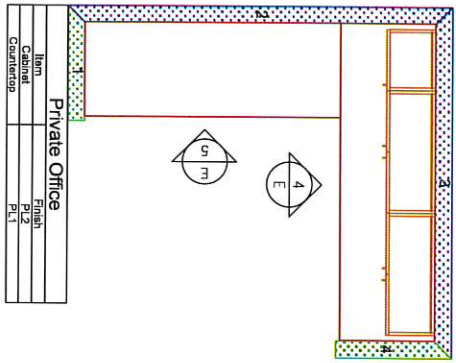

Sheet No.: Sheet 4	Drawn By: Scott Marrs Date: 06/03/19	Terrell Mint Dentistry SHEET TITLE: Private Office	 AEP MILLWORK CUSTOM CABINETS + COUNTERTOPS 817.522.4542
------------------------------	---	--	---

Clinical Storage	
Turn	Finish
Standard	Veneer Material

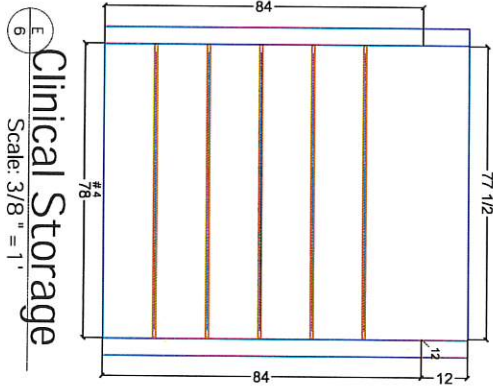

Clinical Storage
Scale: 3/8" = 1"

Sheet No.:
Sheet 5

Drawn By:
Scott Marrs
Date:
06/03/19

Terrell Mint Dentistry
SHEET TITLE:
Clinical Storage

AEP MILLWORK
CUSTOM CABINETS + COUNTERTOPS
817.522.4542

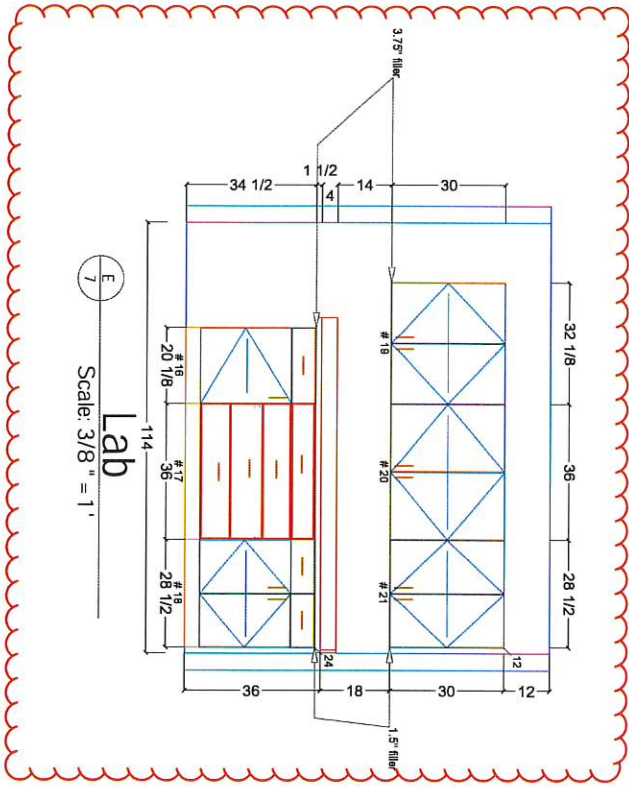

Lab 7
Scale: 3/8" = 1'

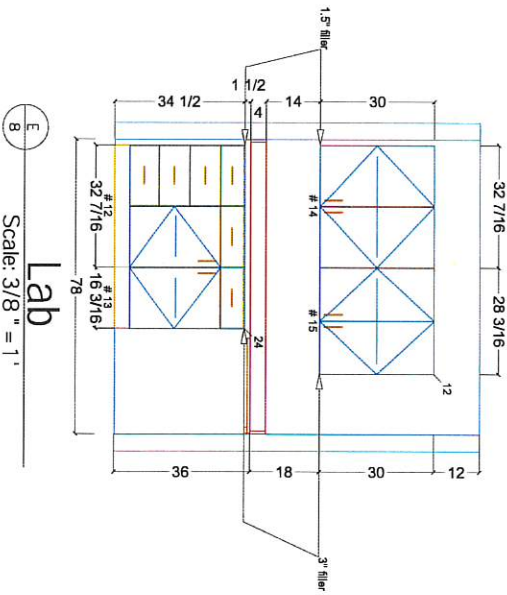

Lab 8
Scale: 3/8" = 1'

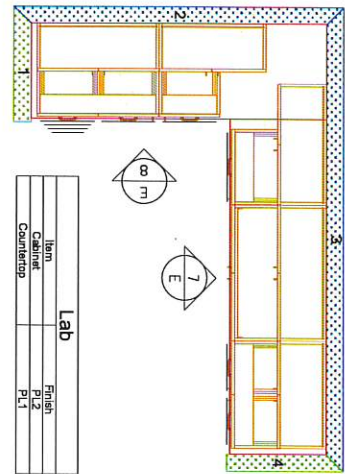

Lab	
Item	Finish
Cabinet	PL2
Countertop	PL1

Sheet No.:
Sheet 6

Drawn By:
Scott Marrs
Date:
06/03/19

Terrell Mint Dentistry

SHEET TITLE:

Lab



817.522.4542

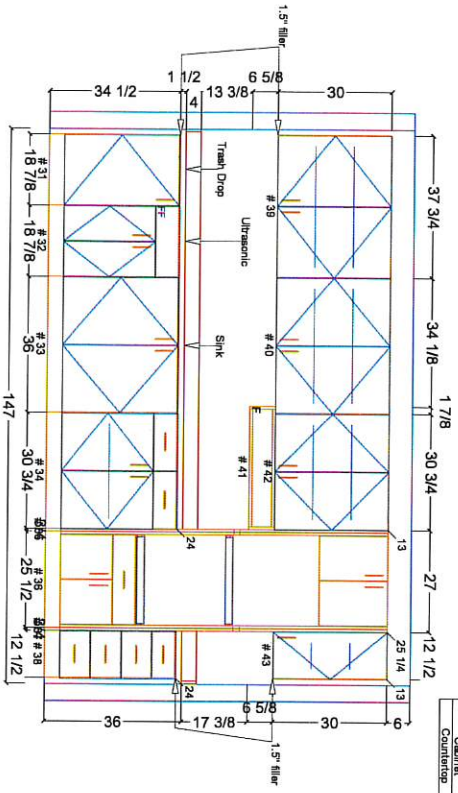

Sterile
Scale: 3/8" = 1'

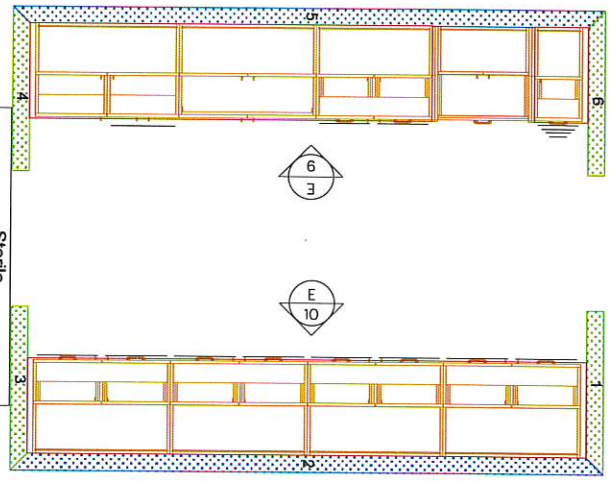

Item	Finish
Cabinet	P1.2
Countertop	P1.2

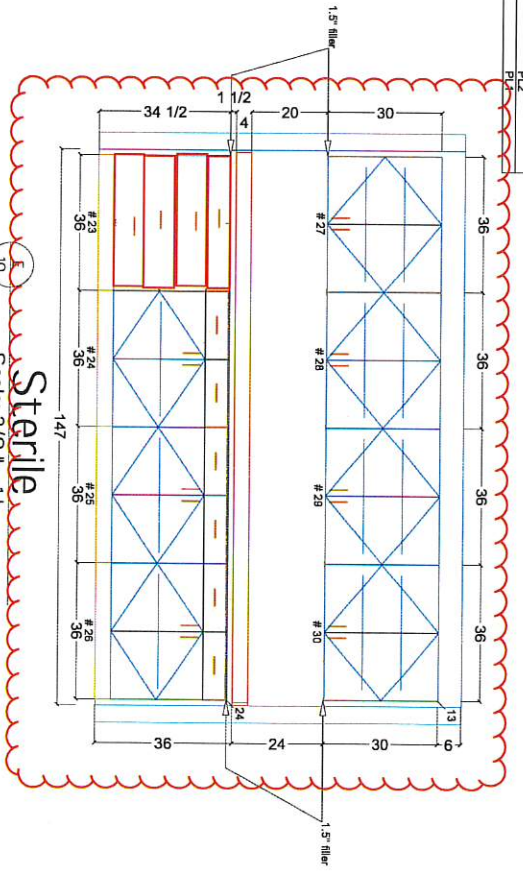

Sterile
Scale: 3/8" = 1'

Sheet No.:
Sheet 7

Drawn By:
Scott Morris
Date:
06/03/19

Terrell Mint Dentistry
SHEET TITLE:
Sterile

AEP MILLWORK
CUSTOM CABINETS + COUNTERTOPS
817.522.4542

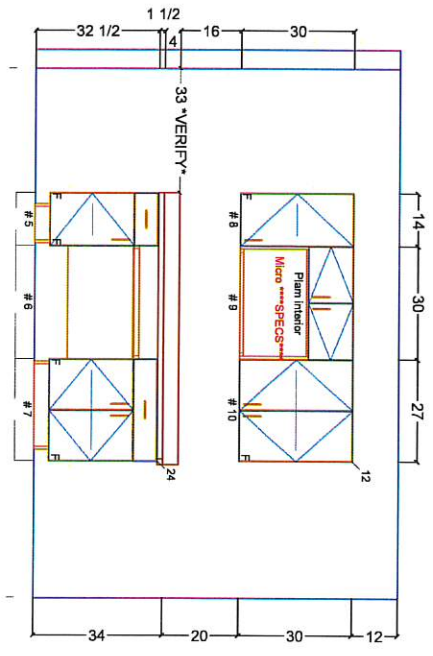
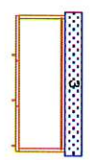
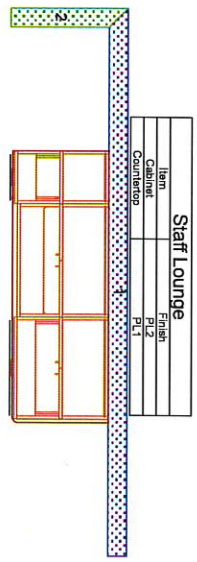

E-11
Staff Lounge
Scale: 3/8" = 1'1"

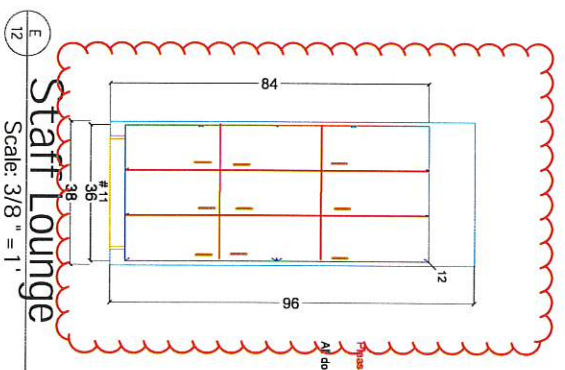

E-12
Staff Lounge
Scale: 3/8" = 1'1"

Please specify what wall this is to go on
All doors to receive Padlock Hasp Cam style lock

Sheet No.:
Sheet 8

Drawn By:
Scott Marrs
Date:
06/03/19

Terrell Mint Dentistry
SHEET TITLE:
Staff Lounge

AEP MILLWORK
CUSTOM CABINETS + COUNTERTOPS
817.522.4542

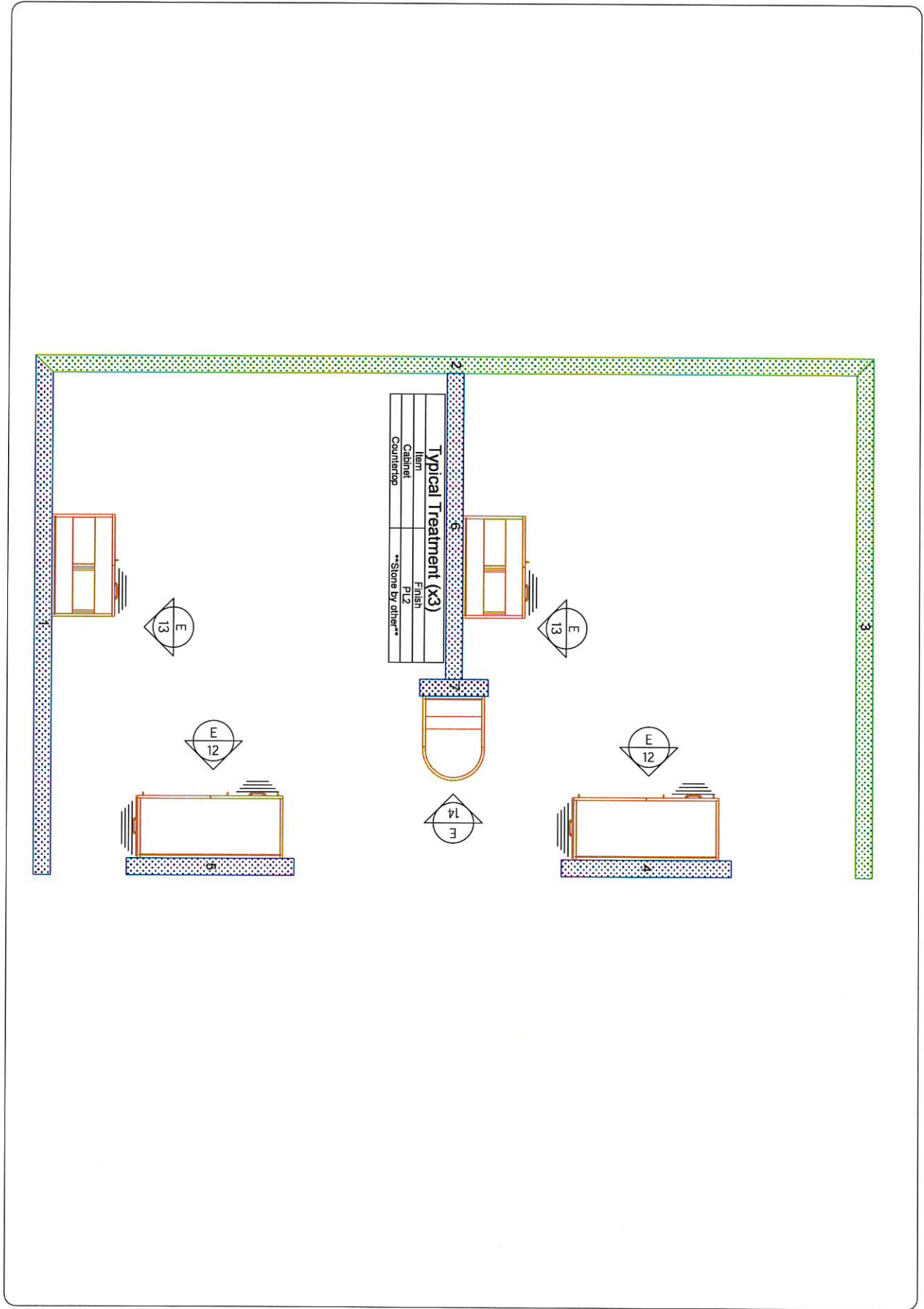

Sheet No:
Sheet 9

Drawn By:
 Scott Marrs
 Date:
 06/03/19

Terrell Mint Dentistry
 SHEET TITLE:
Typical Treatment (x3)

AEP MILLWORK 
 CUSTOM CABINETS + COUNTERTOPS
 817.522.4542

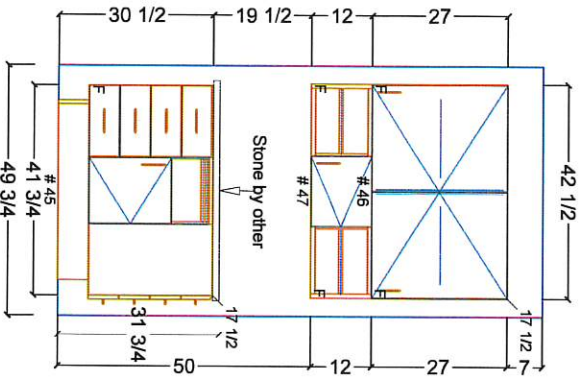

E
16
Typical treatment (x6)
Scale: 1/2" = 1'

**note: drawers to have typical Mint divider layout

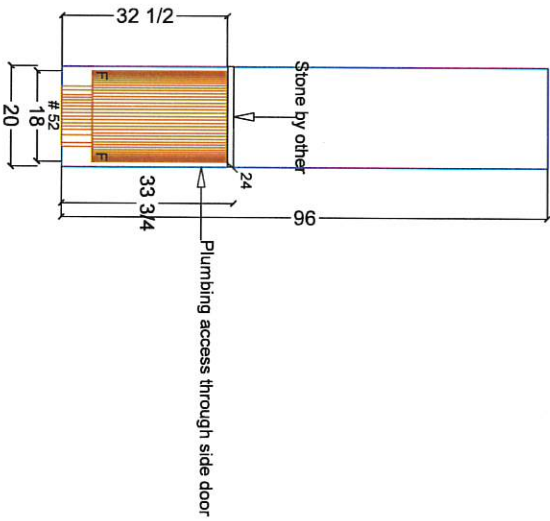

E
17
Typical Treatment (x3)
Scale: 1/2" = 1'

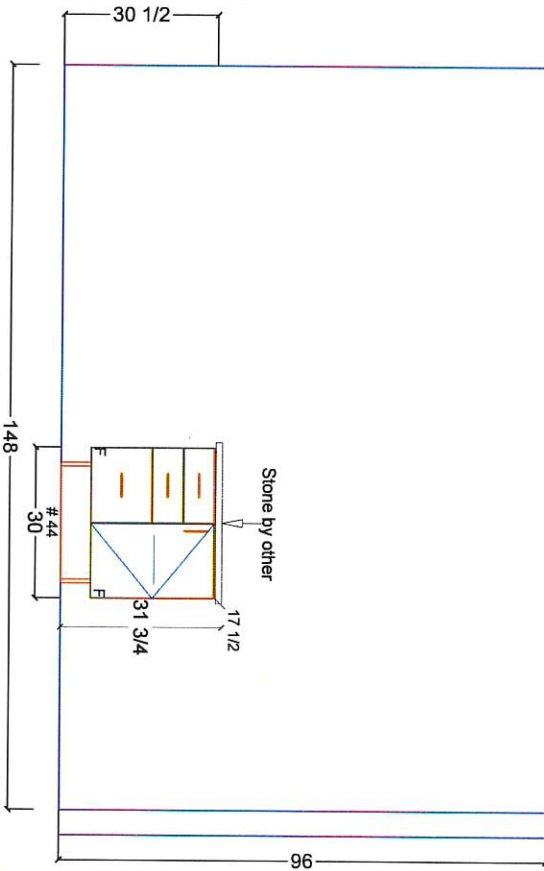

⊕ E
18

Typical treatment (x6)
Scale: 1/2" = 1'

**note: drawers to have typical Mint divider layout

Drawn By:
Scott Marrs
Date:
06/03/19
Sheet No.:

Terrell Mint Dentistry
SHEET TITLE:
Typical Treatment (x3) (cont.)

AEP
MILLWORK
CUSTOM CABINETS + COUNTERTOPS
817.522.4542

