

MISSISSIPPI STORM WATER POLLUTION PREVENTION PLAN (SWPPP) GUIDANCE MANUAL FOR CONSTRUCTION ACTIVITIES

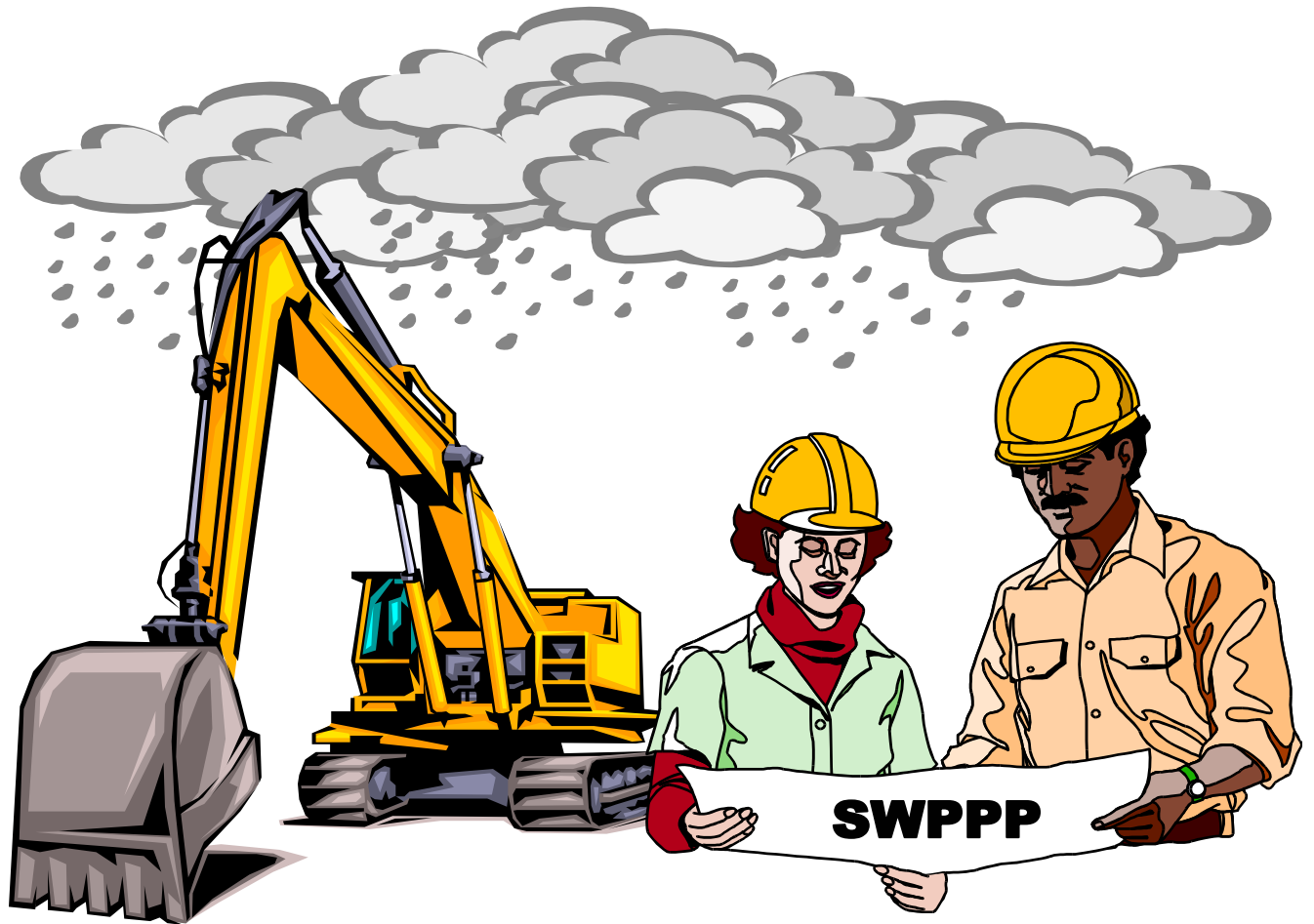

*General Permits Branch
Office of Pollution Control
Mississippi Department of Environmental Quality
P. O. Box 10385
Jackson, Mississippi 39289-0385
May 2005*

TABLE OF CONTENTS

	<u>Page</u>
INTRODUCTION	3
PART I COLLECT SITE INFORMATION	4
PART II CHOOSE CONTROLS.....	5
PART III PREPARE SWPPP	15
PART IV APPLY FOR PERMIT COVERAGE.....	16
PART V IMPLEMENT CONTROLS	16
PART VI STABILIZE SITE & TERMINATE COVERAGE.....	16
SAMPLE STORM WATER POLLUTION PREVENTION PLAN (SWPPP).....	17
SAMPLE SITE MAP.....	18
SAMPLE STORM WATER POLLUTION PREVENTION PLAN FOR INDIVIDUAL LOTS IN A RESIDENTIAL SUBDIVISION	19
INDIVIDUAL RESIDENTIAL LOT SWPPP SAMPLES.....	21
WORKSHEET 1 – CHECKLIST SHEET FOR EROSION & SEDIMENT CONTROLS	22
FREQUENTLY ASKED QUESTIONS	23
EROSION & SEDIMENT CONTROL MANUAL ORDER FORM	26
 CHARTS 	
CHART 1 - SEEDING CHART FOR THE STATE OF MISSISSIPPI	7

This manual is primarily derived from Chapters 2, 3 and 4 of EPA's "Storm Water Management for Construction Activities, Developing Pollution Prevention Plans and Best Management Practices," September 1992, and Chapters 3, 4 and 5 of The Mississippi Department of Environmental Quality, Mississippi Soil & Water Conservation Commission and USDA Soil Conservation Service's "Planning & Design Manual for the Control of Erosion, Sediment & Stormwater," April 1994. It was originally edited by Mississippi Office of Pollution Control staff Kenneth LaFleur and Louis Lavallee, and most recently by Jim Morris, Kenneth LaFleur, and Brigid Steed, who thank those who reviewed and commented on the draft. See our web site for more Storm Water information at www.deq.state.ms.us.

INTRODUCTION

This document is a guide for developing a **Storm Water Pollution Prevention Plan (SWPPP)** for the Mississippi Department of Environmental Quality (MDEQ) as required in the State of Mississippi's Large and Small Construction Storm Water General NPDES Permits. The Large Construction General Permit authorizes storm water discharges from land disturbing activities of five (5) acres or greater; or for land disturbing activities that are part of a larger common plan of development or sale that will disturb five (5) or more acres. The Small Construction General Permit authorizes storm water discharges from land disturbing activities of one (1) acre to less than five (5) acres; or for land disturbing activities less than one (1) acre that are part of a larger common plan of development or sale that will disturb one (1) to less than five (5) acres. These permits should be consulted for complete requirements. For a more thorough description of erosion and sediment controls, see the most recent edition of the "**Planning & Design Manual for the Control of Erosion, Sediment & Stormwater**," MDEQ, MSSWCC, U. S. Dept. of Agriculture NRCS (which may be purchased from the MDEQ by completing the form found on page 26, or the electronic form at <http://abe.msstate.edu/csd/p-dm/>).

This document is organized according to the six parts of SWPPP planning and implementation:

- **PART I** **Collect Site Information**
- **PART II** **Choose Controls**
- **PART III** **Prepare SWPPP**
- **PART IV** **Apply for Permit Coverage**
- **PART V** **Implement Controls**
- **PART VI** **Stabilize Site & Terminate Coverage**

When developing a SWPPP, always consider the following items:

- C **Disturb** the smallest area possible. Remember, by disturbing large areas that have high erosion potential, the cost of erosion and sediment controls will greatly increase.
- C **Preserve** existing vegetation where possible, especially trees.
- C **Avoid** disturbing sensitive areas such as:
 - Steep and/or unstable slopes.
 - Land upslope of surface waters.
 - Areas with erodible soils.
 - Existing drainage channels.
- C **Divert** upslope water around disturbed areas.
- C **Limit** exposure of disturbed areas to the shortest time possible.
- C **Re-vegetate** disturbed areas as soon as possible.
- C **Slow rainfall runoff velocities** to prevent erosive flows.
- C **Remove sediment from storm water before it leaves the site** by allowing runoff to pond in controlled areas to drop out sediment. Filter runoff by using natural vegetation, brush barriers, silt fences or hay bales.
- C **Transport runoff** down steep slopes through lined channels or piping.
- C **Minimize** the amount of cut and fill.

PART I

COLLECT SITE INFORMATION

- C **Existing soils information** - *Are the soils susceptible to erosion?* For information see the Natural Resources Conservation Service (NRCS) soil surveys or call the State Conservationist through the State Office in Jackson at **(601) 965-5196** or **5205**. The NRCS is the former Soil Conservation Service.
- C **Receiving water(s)** - Identify any lakes, streams, ponds or wetlands that may receive site runoff. If sensitive water bodies are downstream (for example: wild and scenic rivers, recreational streams, natural aquatic sites, private ponds and lakes or receiving streams listed on the Impaired Water Bodies 303(d) list) extra erosion controls may be needed. A discussion of the Impaired Water Bodies 303(d) list follows. For assistance, see the appropriate USGS Quad map(s), a photocopy of which must be submitted along with the SWPPP. To obtain USGS Quad maps contact the Mississippi Office of Geology at **(601) 961-5523**.
- C **List of Impaired Water bodies (Pursuant to Section 303(d) of the Clean Water Act)** - Mississippi's waters are used for public water supply, shell fish harvesting, recreation, and fishing & aquatic life support. The MDEQ assesses State waters every two years to determine if their uses are supported. A water body is said to be impaired when its use is partially or non-supportive. Construction sites, whose receiving streams are on the list of impaired waters due to siltation, suspended solids, sediment, turbidity or habitat alterations, require additional erosion and sediment controls. These additional controls are intended to ensure that sediment will not further impact those impaired waters. For more information concerning 303(d) listed streams, please contact the Water Quality Assessment Branch of the MDEQ at **(601) 961-5171**.
- C **U. S. Army Corps of Engineers** - If your project is rerouting, filling or crossing a water conveyance of any kind, you should contact the U. S. Army Corps of Engineers, Regulatory Branch in your area for possible permitting requirements. For information call the Vicksburg Corps District at **(601) 631-5289** or **5290** or the Mobile Corps District at **(334) 694-3776**.
- C **Calculating total acreage disturbed** – Total acreage disturbed includes the total area disturbed over the course of the project. For subdivisions, this includes roads, utilities, drainage and home sites. A minimum of 10,000 ft² per home site or the entire lot, if smaller, shall be included. Acreage may be determined by dividing square footage by 43,560, as demonstrated in the following example:
- Convert 54,450 ft² to acres (*square footage is obtained by multiplying the length of the disturbed area by the width of the disturbed area*)
- C Divide 54,450 ft² by 43,560 square feet per acre:
C 54,450 ft²) 43,560 ft²/acre = 1.25 acres
(Small construction coverage would be required for 1.25 acres)
- C **Determine drainage areas** - For each point where concentrated flow will leave the site, the drainage area should be determined. Drainage areas are portions of the site where runoff will flow in one particular direction or to a particular discharge point. This will help you select and design the appropriate sediment controls. The USGS Quad map(s) may be useful in determining drainage areas.

PART II

CHOOSE CONTROLS

Select vegetative and structural controls; housekeeping practices; post-construction/storm water management measures & controls to be used prior to, during and after land disturbing activities. The SWPPP must include a description of the measures and controls that will be used throughout the construction project. Incorporate any municipal, county or other required controls into your SWPPP.

1. **Vegetative controls** are an inexpensive and effective way to protect soil from raindrop impact, a major erosion force. It also decreases erosion due to flowing water by reducing its velocity. Roots from vegetation hold the soil in place and increase infiltration. **Topsoil should be added where existing soils are not suitable for adequate vegetative growth.** Amendments may include composted manures, sawdust or sludge. Check with the MDEQ, Solid Waste Branch, at (601) 961-5171 before using sewage sludge.

- C **Vegetative buffer zones** are undisturbed or planted vegetated areas that surround a development, land disturbance activity or that border an intermittent stream or permanent water body. Buffer zones aid in sediment filtration and removal. If possible, construction site runoff should be spread out over entire buffer zone length.

A minimum 15-foot wide buffer zone is recommended. A minimum 150-foot buffer zone is recommended adjacent to perennial streams and water bodies.

- C **Sod stabilization**, the most effective vegetative practice available, involves establishing long-term stands of grass with sod on exposed surfaces. Properly installed and maintained sodding can be more than 99 percent effective in reducing erosion.

- C **Protection of trees** involves preserving and protecting selected trees that exist on the site prior to development. Mature trees provide extensive canopy and root systems that hold soil in place. It is important to provide tree protection to the tree drip line rather than only around the perimeter of the trunk. Shade trees also keep soils from drying rapidly and becoming susceptible to erosion, as well as increasing property value.

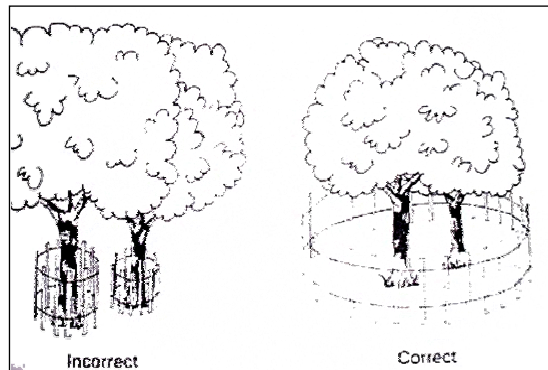

- C **Tillage, with lime and fertilizer**, may be important before seeding. The Cooperative Extension Service local agent can analyze soil for lime and fertilizer needs.

- C **Temporary seeding** is the planting of fast-growing annual grasses to hold the soil in areas that will not be disturbed again for 30 or more days. For long term protection (greater than one year), permanent seeding should be initiated. The seeding chart on page 7 lists annuals that may be used. Mulching helps insure seed growth and is essential when slopes are steep, weather is hot or dry and soil conditions are poor.

- C **Permanent seeding** is the use of perennial grass (with trees & shrubs) to stabilize the soil. The seeding chart on page 7 lists perennials that may be used. Vegetation is often not fully established until one year from planting. Inspect, repair and re-seed as needed, evaluating choice of seed and quantities of lime and fertilizer. Use temporary seeding if the time of year is not appropriate for permanent seeding. **Sodding may be needed in highly erodible areas.**

- C **Mulching** is the placement of hay, grass, wood chips, straw, or synthetic material on the soil. Mulch holds moisture, dampens temperature extremes and retards erosion on steep slopes during seed establishment. Soils that cannot be seeded due to the season should be mulched to provide temporary protection.
- C **Erosion & sediment control blankets** are machine-produced mats of straw or other fibers held together with netting that provide temporary or permanent stabilization in critical areas, such as slopes or channels, so that vegetation may be established. On slopes shallower than 2:1, blankets should be laid perpendicular to the direction of flow. However, on steep slopes (> 2:1) and in areas of concentrated flows (ditches, swales, storm water conveyance channels), blankets should be laid in parallel to the direction of flow. Blankets should be anchored in a 6 inch trench and should overlap by 3 inches if strips are laid side by side.
- C **Surface roughening** involves using heavy equipment to create grooves on bare soil in a perpendicular direction across the slope. Roughening loosens compacted soils in order to reduce runoff velocity and erosion while aiding in seed growth. Roughened slopes should be immediately seeded and mulched.

Slopes that will be mowed should be grooved with shallow grooves 1 to 3 inches deep and no further apart than 10 to 12 inches.

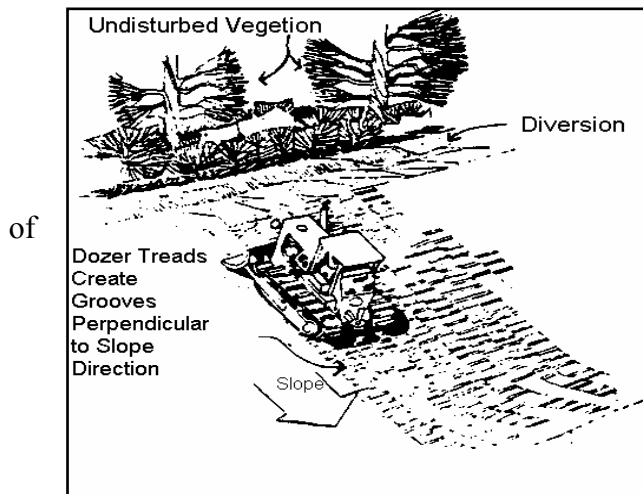
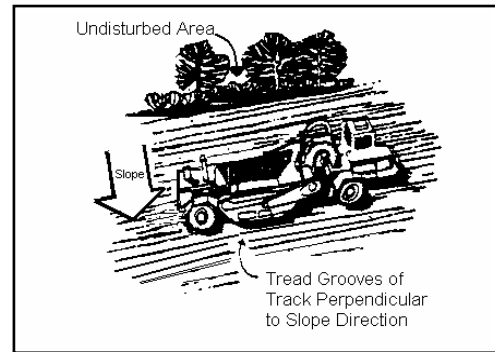

Cut slopes that will not be mowed can either be "stair-stepped" or grooved. If stair-step grading, the horizontal portion each step must be longer than the vertical portion and should be sloped into the vertical portion. Individual vertical cuts should be no higher than 24 inches or 36 inches if the material is rocky.

SEEDING CHART FOR THE STATE OF MISSISSIPPI

SPECIES	SEEDING RATE/ACRE	PLANTING TIME	DESIRED pH RANGE	FERTILIZATION RATE/ACRE	METHOD OF ESTABLISHMENT	ZONE OF ADAPTABILITY ¹
Common Bermuda	15 lbs. alone 10 lbs. mixture	3/1 - 7/15 9/1 - 11/30	6.0 - 7.0	600 lbs. 13-13-13	seed or sod	All
Bahia	40 lbs. alone 30 lbs. mixture	3/1 - 7/15 9/1 - 11/30	6.0 - 7.0	600 lbs. 13-13-13	seed	Central South
Fescue	40 lbs. alone 30 lbs. mixture	9/1 - 11/30	6.0 - 7.0	600 lbs. 13-13-13	seed	North Central
Saint Augustine	--	3/1 - 7/15	6.0 - 7.0	600 lbs. 13-13-13	sod only	Central South
Centipede	4 lbs. alone 2.5 lbs. mix	3/1 - 7/15	6.0 - 7.0	600 lbs. 13-13-13	seed or sod	All
Carpet Grass	15 lbs. alone 10 lbs. mixture	3/1 - 7/15	6.0 - 7.0	600 lbs. 13-13-13	seed or sod	All
Oysia Grass	--	3/1 - 7/15	6.0 - 7.0	600 lbs. 13-13-13	sod only	All
Creeping Red Fescue	30 lbs. alone 22.5 lbs. mix	9/1 - 11/30	6.0 - 7.0	600 lbs. 13-13-13	seed	All
Weeping Lovegrass	10 lbs. alone 5 lbs. mix	3/1 - 7/15	6.0 - 7.0	600 lbs. 13-13-13	seed	All
Sericea Lespedeza	40 lbs.	3/1 - 7/15 9/1 - 11/30	6.0 - 7.0	400 lbs. 6-24-24	seed	All
*Wheat	90 lbs. alone	9/1 - 11/30	6.0 - 7.0	600 lbs. 13-13-13	seed	All
*Ryegrass	30 lbs.	9/1 - 11/30	6.0 - 7.0	600 lbs. 13-13-13	seed	All
*White Clover	5 lbs.	9/1 - 11/30	6.0 - 7.0	400 lbs. 6-24-24	seed	All
*Crimson Clover	25 lbs. alone 15 lbs. mix	9/1 - 11/30	6.0 - 7.0	400 lbs. 6-24-24	seed	All
*Hairy Vetch	30 lbs.	9/1 - 11/30	6.0 - 7.0	400 lbs. 6-24-24	seed	All
*Browntop Millet	40 lbs. alone 15 lbs. mix	4/1 - 8/30	6.0 - 7.0	600 lbs. 13-13-13	seed	All

* Annuals. For permanent seeding, annuals can only be used in a mixture with perennials.

North- north of Hwy. 82

Central- south of Hwy. 82 & north of Hwy. 84

South- South of Hwy. 84

2. **Structural Controls** divert flows away from disturbed areas, reduce runoff velocities, filter out sediment and remove sediment by ponding.

Temporary structures are installed before and during construction. After removing temporary storm water controls the area should be vegetated. **Permanent structures** remain after construction.

- C **Diversion** ridges or channels of stabilized soil can divert off-site runoff from disturbed areas or sediment-laden runoff into sediment basins. If diversions will remain in place more than 30 days they should be covered with temporary or permanent vegetation. Diversions must have enough grade to assure drainage, but not enough

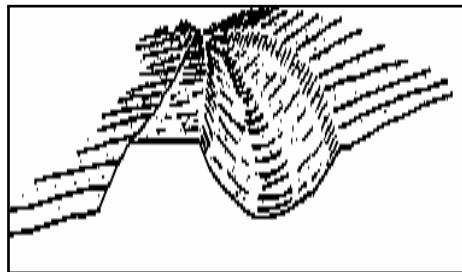
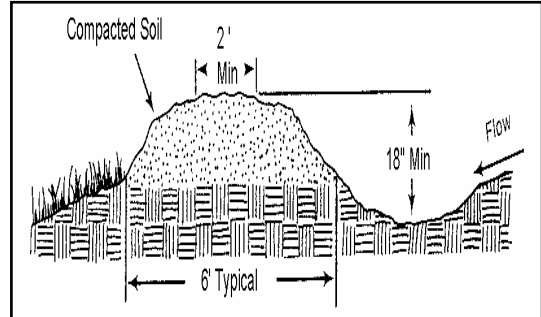

to cause erosion within the channel. Allow sufficient room around diversions to accommodate machine regrading, if needed. The maximum allowable drainage area is five acres.

- C **Silt fences** are used below small disturbed areas to capture sediment from sheet flow. Eight inches of fence should be buried in a trench about four inches deep and four inches wide. **Silt fences that are not buried are improperly installed, have no useful function, are a waste of money, and could result in substantial fines.** The maximum slope length behind a fence is 100 feet with maximum gradient two horizontal to one vertical. Under no circumstances should silt fences be installed across flowing streams. They may be placed in minor swales or ditch lines where the maximum contributing drainage area is no more than two acres. The fence must be maintained and the sediment removed when deposits reach one-half the fence height. After the fence is no longer needed, the area should be graded, seeded and mulched.

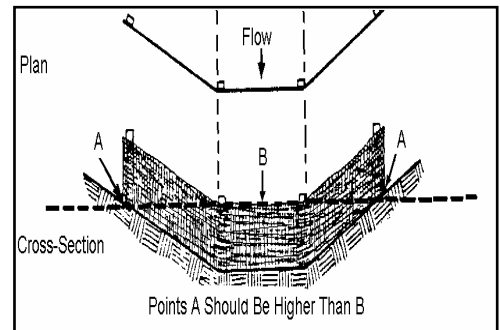

Install fence steel fence posts or 4 inch diameter wooden posts that are 5 feet in length. Posts should be installed starting at the center of the

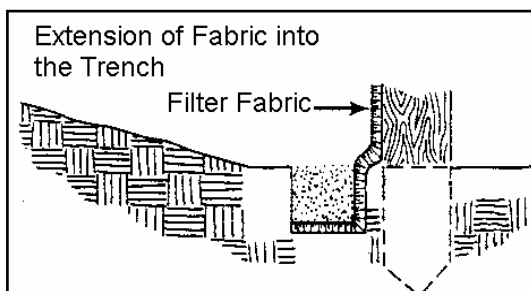

lowest point of the fence line and be driven 12 inches into the ground. Allow 6 inch overlap at joints. Machines that install silt fences are also acceptable methods of installation.

C

Straw bale barriers are also used on small disturbed areas to capture sediment from sheet flow. The drainage area must be restricted to 1/8 acre per 100 feet of barrier. Maximum gradient behind the barrier is three horizontal to one vertical. The barrier must be located so that the water depth does not exceed one foot at any point. Straw bales, with bindings oriented around the sides, shall be entrenched a minimum of four inches and anchored with two stakes driven toward the

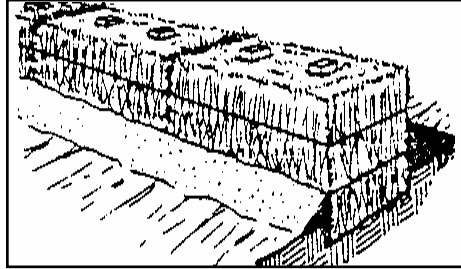

previously laid bale. **Straw bales that are not buried are improperly installed, have no useful function, are a waste of money, and could result in substantial fines.**

Bales should be placed so that the ends are tightly abutting each other. Bales should be staked down using 1" x 2" wood stakes or rebar. Use 2 stakes per bale and angle the first stake towards the previously laid bale. Stakes should be long enough to go through the bale and into the ground a minimum of 12 inches.

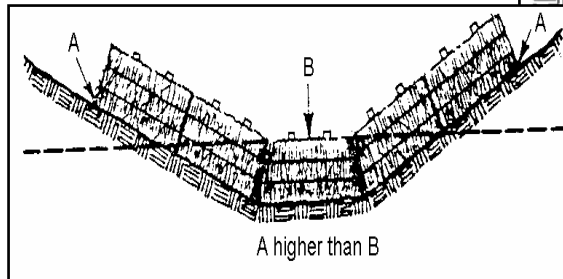
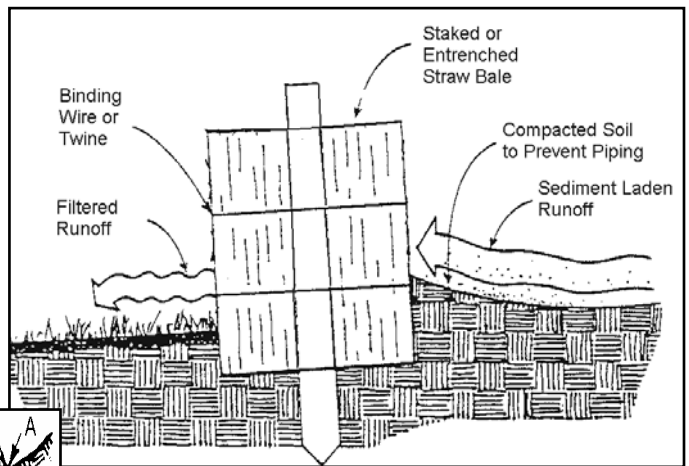

s between bales shall be wedged with straw. Loose straw scattered immediately uphill increases barrier efficiency. Under no circumstances should straw bale barriers be constructed in live streams. For minor dry swales, the end bale bottoms shall be higher than the

middle bale top to assure runoff will not flow around the barrier. Repair damaged bales, end runs and undercutting. Remove sediment when it reaches one-half barrier height. When upslope areas are stabilized, remove bales and grade, seed and mulch barrier line.

- C **Storm drain inlet protection** is a sediment filter (aggregate, silt fence, straw bales, or manufactured filter) or an excavated sediment trap around a storm drain inlet. Storm sewers installed before their drainage area is stabilized can convey large amounts of sediment to streams. Straw bale and silt fence inlet protection are used for drainage areas of less than one acre and slopes no greater than 5 percent.

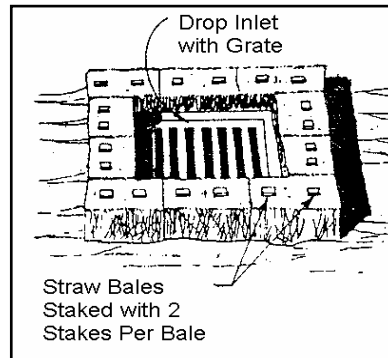
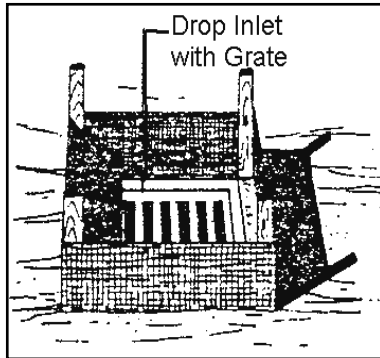

- C **Sediment basins** allow sediment to settle out. Sediment basins are made by diking, excavating or a combination of the two. The Planning and Design manual recommends a basin capacity of 134 yd³ per acre drainage area. Because of typical basin shapes and embankment side slope requirements of 2:1 or flatter, the capacity of the basin may be estimated by using the trapezoidal rule approximation of 40% x height x surface area. Sediment should be removed when the volume has been reduced to 67yd³ per acre drainage area. The length should be twice the width, with maximum surface area and outlet as far from the inlet as possible. If using a dike, it must be well compacted and vegetated, with an outlet pipe or coarse aggregate spillway. Install basins prior to construction but not in flowing streams and not in intermittent drains without a Corps of Engineers Permit. Use diversions to direct drainage to basins. Mississippi's Large Construction Storm Water General Permit requires that a sediment basin be installed in any drainage location where more than 10 acres in the upstream basin are disturbed at one time. See Planning and Design manual for basin design details.

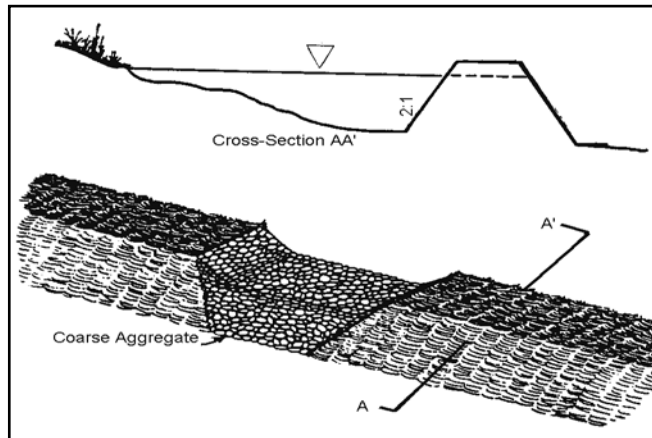

C

Slope drains are piping or lined channels carrying storm water downslope without erosion. Runoff is directed to the drain by earthen diversion with a minimum height of 18 inches. At the inlet, the diversion and inlet cover must be 6 inches higher than the top of the piping. The diversion and especially the inlet cover must be well compacted. Install piping hold-downs at 10-foot intervals and line the outlet area with riprap or other material to prevent scour and undermining. The maximum drainage area per drain should be five acres. Permanent slope drains would be subsurface or paved flumes.

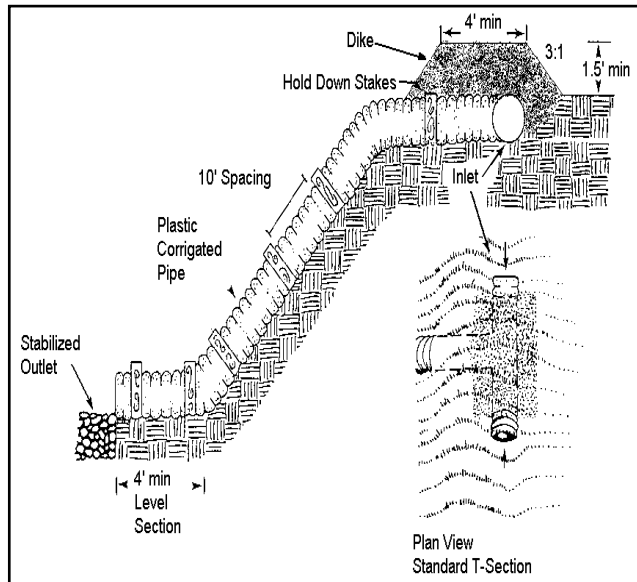

6 inches higher than the top of the piping. The diversion and especially the inlet cover must be well compacted. Install piping hold-downs at 10-foot intervals and line the outlet area with riprap or other material to prevent scour and undermining. The maximum drainage area per drain should be five acres. Permanent slope drains would be subsurface or paved flumes.

SIZE OF SLOPE DRAIN

Maximum Drainage Area (Acres)

Piping Diameter (Inches)

- 0.5
- 0.75
- 1.5
- 2.5
- 3.5
- 5.0

- 12
- 15
- 18
- 21
- 24
- 30

C

Slope breaks, diversions or benches, are used to reduce the slope length of a cut or fill to minimize rill erosion and prevent gullying. Drainage area should be less than one acre.

Slope Breaks		
Slopes	Spacing (ft)	
Steep Slopes	2:1	20
	3:1	35
	4:1	45
Gradual Slopes	15 - 25%	50
	10 - 15%	80
	6 - 10%	125
	3 - 6%	200
	<3%	300

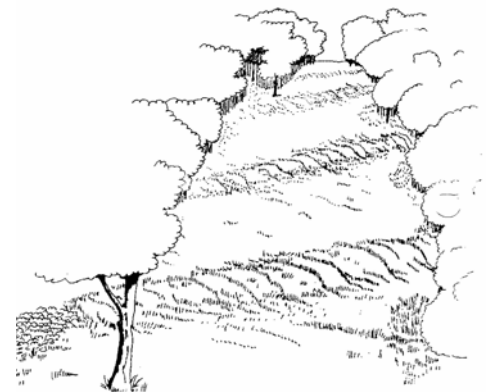

- C **Riprap outlet protection** is placed at the outlet end of culverts or channels to reduce the depth, velocity and energy of water so that the flow will not erode the receiving downstream reach.

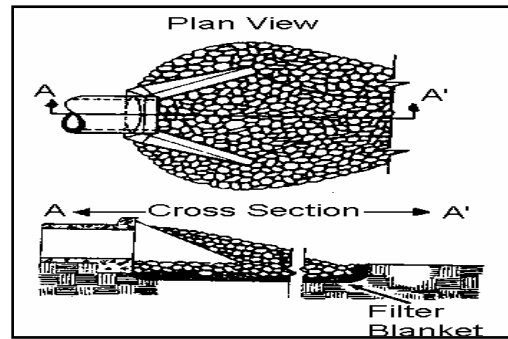

- C **Check dams** are small dams constructed across swales or drainage ditches to reduce flow velocity and erosion. The purpose of a check dam is to prevent erosion of the swale or drainage ditch. They are not used in streams. Check dams can be constructed of stone, straw bales, or logs, with a maximum height of two feet. **The check dam center must be at least 6 inches lower than the outer edges to prevent erosion around the edges.**

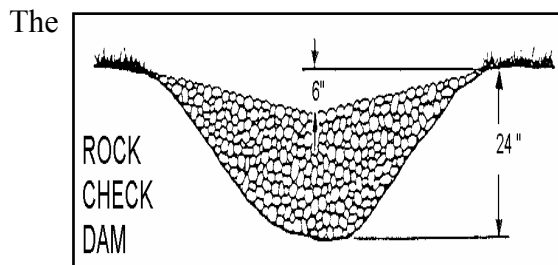

maximum spacing between dams should be such that the toe of the upstream dam is at the same elevation as the top of the downstream dam. Sediment will accumulate and should be removed from behind the check dams when it reaches one half the dam height. Erosion around dam edges should be corrected immediately, insuring that the dam center is six inches lower than the edges. In grass-lined

ditches, grass must be established prior to dam removal. The dam site should be seeded and mulched or sodded, as needed. The use of check dams should be limited to small open channels that drain 10 acres or less.

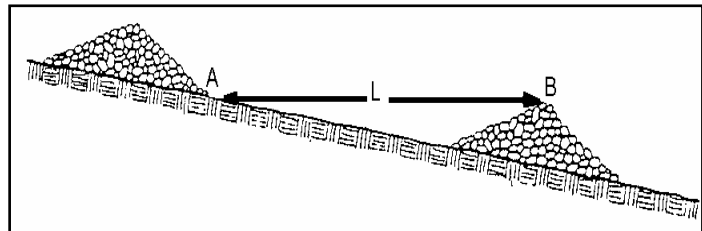

- C **Construction entrance/exits** are stone stabilized site entrances which reduce sediment transferred onto public roads. Aggregate should be at least six inches thick and 50 feet long. Tire washing may also be needed.

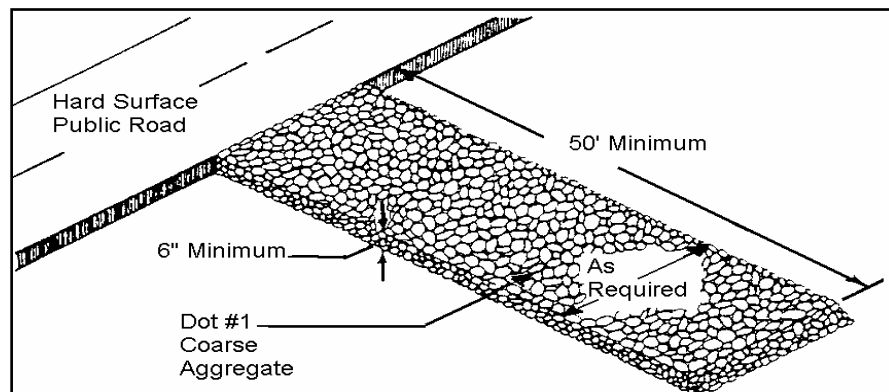

- C **Level spreaders** are diversion outlets allowing the flow to disperse uniformly over surrounding vegetated areas. Spreaders should be constructed on undisturbed soil with downstream areas having established vegetation. Used to divert upslope waters around disturbed areas.

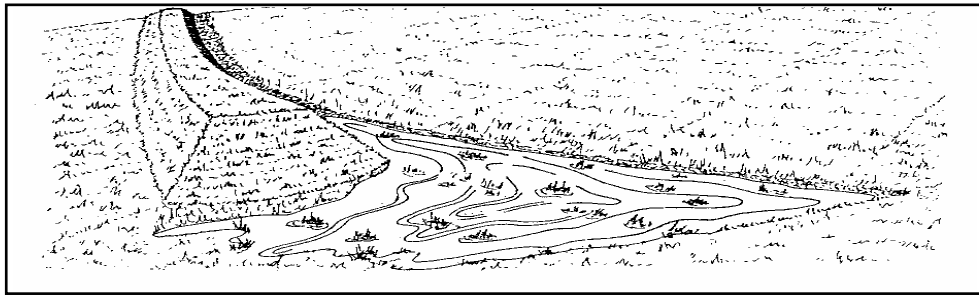

3.

Controls for individual lots in subdivisions and commercial developments.

The Large Construction Storm Water General Permit specifies that individual lots within residential and commercial developments, “that are part of a larger common plan of development or sale” are regulated regardless of size or owner. Therefore, requirements have been established for commercial and residential lots regarding storm water pollution prevention for lots and parcels that are sold by the original coverage recipient.

Commercial development: The original coverage recipient responsible for all construction activities until individual lots or parcels within the development are sold to others and the new owner submits a Large Construction Notice of Intent, SWPPP and obtains coverage. For commercial development, a SWPPP must be developed and submitted along with the LCNOI.

Residential Subdivision: The original coverage recipient is responsible for construction activities until the new owner or operator submits the Registration Form for Residential Lot Coverage and develops and implements a sediment and erosion control plan, submits a LCNOI and required documents, or applies for an individual storm water permit. Homebuilders are required to minimize off-site damage from soil erosion, sediment leaving the construction site, and poor "housekeeping" practices. Examples of individual lot sediment and erosion control plans are attached for your convenience. Sketch the controls on a copy of your site plan. Narrative notes on the site plan may also be used in addition to the erosion control symbols. In developing and implementing the plan, controls must be used from each control group (vegetative, structural, housekeeping) to prevent erosion and sediment and other pollutants from leaving the site.

4. **Housekeeping Practices.** Pollutants that may enter storm water from construction sites because of poor housekeeping may include, but are not limited to oils, grease, paints, gasoline, solvents, litter, debris, and sanitary waste.

The SWPPP should:

- C designate areas for equipment maintenance and repair;
- C designate areas for equipment wash off (i.e., concrete chute wash off);
- C provide waste receptacles at convenient locations and provide regular collection of waste;
- C provide protected storage areas for chemicals, paints, solvents, fertilizers, and other potentially toxic materials; and
- C provide adequately maintained sanitary facilities.

5. **Post - Construction/Storm Water Management Measures.** The Storm Water Construction General Permits require that the SWPPP describe any measures that will be installed and implemented to control pollutants in storm water after construction is complete. These controls include, but are not limited to, one or more of the following:

C **Detention ponds** detain runoff in a basin for a limited time releasing it slowly, allowing most of the sediment to drop out.

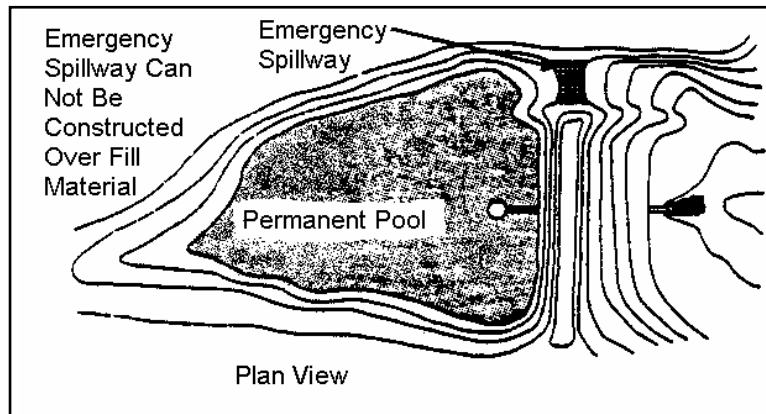

C **Retention Ponds** provides complete onsite storage and treatment of a specific volume of storm water runoff by using infiltration and evaporation. The specific volume is typically the first inch or half inch of storm water runoff containing “the first flush” of pollutants.

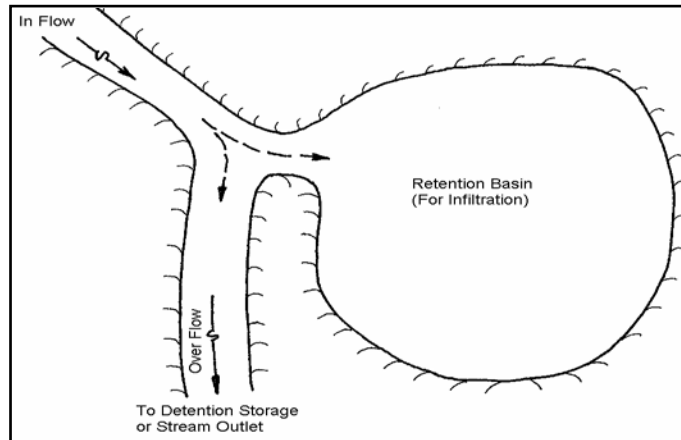

C **Constructed wetlands** are modified natural or constructed shallow basins for treatment of waters by wetland vegetation. Constructed wetlands are operated wet. They can achieve a high removal rate of sediments, BOD, organic nutrients and metals. They can also create wildlife habitat, recreation, and landscape amenities as well as corresponding higher property values.

C **Vegetated swales and natural depressions** are grass-lined, filtering sediments from the runoff and preventing erosion. Vegetated swales should have side slopes of 4:1 or flatter.

C **Velocity dissipation devices** prevent erosion from high runoff velocity, such as **riprap** placed at the discharge point.

C **Exfiltration trenches** are a feasible option where soils are permeable and the water table is well below the surface. Exfiltration trenches retain storm water for release into the soil. Storm water runoff is temporarily stored in perforated pipe or coarse aggregate and allowed to infiltrate the trench walls and, to some extent, trench bottoms. Trenches require regular maintenance to prevent clogs.

PART III

PREPARE SWPPP

1. **Write a Description of Controls.** Once you have finished selecting the vegetative and structural controls, list each control you plan to implement.
2. **Prepare a scaled site map** showing original and proposed contour lines, drainage ways, north arrow, and all erosion, vegetative and structural sediment controls (an example SWPPP and site plan is attached for construction projects and for individual residential lots).
3. **Implementation Sequence.** Indicate the order in which activities will take place. When work is discontinued for 30 days or more in a disturbed area or completed, appropriate vegetative and structural practices must be initiated within seven calendar days. Several general implementation principles are:
 - **install** downslope and perimeter controls before other site work. Build sediment basins before major site grading.
 - **divert** upslope water around area before major site grading.
 - **do not disturb** an area until it is necessary.
 - **time** construction activities to limit impact from seasonal weather.
 - **cover or stabilize** disturbed areas as soon as possible.
 - **do not remove** temporary controls until after site stabilization.
4. **Inspection and Maintenance Schedules.** A description of an inspection and maintenance schedule for all disturbed areas, material storage areas, and erosion and sediment controls that were identified as part of the plan shall be included in the SWPPP. Non-functioning controls shall be repaired, replaced or supplemented with functional controls within 24 hours of discovery or as soon as field conditions allow. During permit coverage all erosion controls must be inspected at least once per week for a minimum of 4 inspections per month and as often as necessary to ensure that appropriate erosion and sediment controls have been properly constructed and maintained and determine if additional or alternative control measures are required. The MDEQ strongly recommends that coverage recipients perform a “walk through” inspection of the construction site before anticipated storm events. Controls must be in good operating condition until the area they protect has been completely stabilized and the construction activity is complete. The inspection information must be recorded on the forms developed and provided by the MDEQ. These forms are available on the MDEQ website at www.deq.state.ms.us on the General Permits Branch page.

PART IV

APPLY FOR PERMIT COVERAGE

The MDEQ now has two different storm water general permits that cover construction activities in Mississippi. Construction activities that disturb one acre to less than five acres require coverage under the Small Construction General Permit. The requirements of the Small Construction General Permit are similar to the Large Construction General Permit. However, there is one fundamental difference. **The Small Construction General Permit has no submittals to the MDEQ unless specifically requested.** The owner or operator must complete the Small Construction Notice of Intent (SCNOI) and keep the form on the project site or locally available. In addition, the owner or operator must develop and implement a Storm Water Pollution Prevention Plan (SWPPP). The SWPPP must also be kept at the project site or locally available.

For projects that are considered large construction activities, the owner or operator must submit a Large Construction Notice of Intent (**LCNOI**) to the Office of Pollution Control (OPC) along with the **SWPPP** and the **USGS Quad Map** (or copy). The LCNOI summarizes information about you, your site, the prime contractor, and receiving water(s). The LCNOI is due at least 30 days prior to the commencement of construction or 15 days if an approved applicable SWPPP is already on file with OPC. An **authorized representative**, as described in the general permit, must sign the LCNOI. If the owner signs the LCNOI and will not serve as the prime contractor, the prime contractor should sign and submit the Prime Contractors Certification form provided in the LCNOI prior to actual construction.

The plan must be in compliance with applicable local storm water management, erosion and sediment control requirements.

PART V

IMPLEMENT CONTROLS

Erosion and sediment controls shall be constructed and the stabilization measures shall be applied in the order that was indicated in the implementation sequence. It is important that appropriate construction workers are aware of the SWPPP and have ready access to it. The owner or prime contractor must **inspect and maintain** controls, recording damages or deficiencies and corrective measures, and **complete monthly inspection reports** using the form provided by the MDEQ. Problems should be corrected within 24 hours or as soon as practicable after an inspection. Changes to correct deficiencies in the SWPPP should also be made as soon as practicable after the inspection. The SWPPP must accurately reflect the site and construction and be corrected if it does not.

PART VI

STABILIZE SITE & TERMINATE COVERAGE

Upon successful completion of all permanent erosion and sediment controls for a Large Construction project, the Office of Pollution Control must be notified by submission of a Notice of Termination (NOT) form. The NOT form must be fully completed by both the owner and operator and include original signatures by both parties. The NOT form is provided the Storm Water Large Construction General Permit. If the entire NOT form is fully completed and the MDEQ on site inspection does not show any problems, a letter will be sent to the coverage recipient stating the permit has been terminated. At this point, the permittees are relieved of their responsibility.

SAMPLE STORM WATER POLLUTION PREVENTION PLAN (SWPPP)

Site Information

The construction of two commercial buildings and associated pavements will disturb 7.2 acres. Three-fourths of this site has a medium erosion hazard. The remainder of the site has 10 to 20 percent slopes that are highly erodible. An intermittent drain on the north end of the property drains the site to "Any-Name" Creek. "Any-Name" Creek stream is not on the 303(d) list for siltation, turbidity or habitat alterations, therefore additional controls that are warranted for a site discharging to listed receiving streams are not required.

Controls

Vegetative Controls: A 15-foot undisturbed vegetative buffer zone will be maintained around the perimeter of the site. Existing trees will be preserved where possible. All diversions will be seeded (permanent seeding) within seven calendar days of construction. Topsoil will be stockpiled for use in landscaping. Grass-lined waterways will be constructed and lined with temporary straw-net liners and will be constructed around both buildings. All 3:1 cut slopes will be roughened by disking prior to seeding. The slope on the south side of the intermittent stream will be sodded with Bermuda grass. Any disturbed areas that will be left undisturbed for thirty or more days will be seeded (temporary seeding) within seven calendar days. After final grading, all disturbed areas will be seeded (permanent seeding) within seven calendar days.

Structural Controls: A sediment basin will be constructed at the end of the existing intermittent drainage to the north (drainage area: 4.8 acres). A sediment basin will be constructed at the southwest corner of the property where runoff leaves the property. Storm water will be directed to these basins with the assistance of diversions and grassed waterways. Upslope waters will be diverted around disturbed areas. A level spreader will serve as the outlet for the diversion southeast of the buildings. All cut slopes will be at or below a 3:1 grade. A construction entrance will be built and any accumulation of mud on vehicle tires will be washed, if needed, during muddy conditions. Inlet protection (silt fences) will be installed at all storm drain inlets. A silt fence will be constructed around the stockpile. The eroding natural drainage way on the north end of the site will be lined with rip rap (which is covered by a Nationwide Permit # 13 – *an individual 404 Permit is not required because the activity is less than 500 linear feet and has less than 1 cubic yard of rip rap per linear foot - no notification of Corps required.*). Riprap will be placed at all culvert outlet aprons. A sediment pond will be excavated for concrete trucks to wash the mixer chutes and a memo will be sent to the concrete supplier to use a minimum amount of water. Drivers will be instructed to return any materials to the concrete batch plant and complete final washing procedures at that location.

Housekeeping Practices. All equipment maintenance and repair will be done offsite. Trash cans will be placed at convenient locations throughout the site. The main trash collection bin will be located on the northeast corner of the site and will be picked up weekly by the city. Paints, solvents, fertilizers, or any other potentially toxic materials will not be stored onsite. Portable sanitary facilities will be provided for construction workers. There will be a designated area for concrete truck wash off.

Post Construction/Storm Water Management Measures: The temporary sediment basin will be converted to a detention basin after construction. Riprap will be placed at concentrated storm water discharge points to prevent erosion from high runoff velocities.

Implementation Sequence

1/ build construction entrance/exit. 2/ install sediment basin with needed riprap. 3/ contour and riprap intermittent drainage way to the north. 4/ rough grade site, construct diversions and drainage ways, stockpile topsoil and install silt fence around stockpile, install culverts with inlet/outlet protection (silt fence), level spreader and riprap. 5/ plant needed temporary vegetation on disturbed areas. 6/ construct buildings and parking lots. 7/ finish slopes around buildings, roughen slopes and vegetate. 8/ after site is stabilized, remove all temporary measures, vegetating these areas, and convert sediment basin to a detention basin.

Maintenance Plan

Check all disturbed areas, erosion and sediment controls after each significant rainfall but not less than once per week. Make needed repairs within 24 hours. Remove sediment from the basin, inlet protection devices and silt fences when accumulated sediment has reached 50 percent capacity. Replace non-functional silt fence. Maintain all vegetated areas to provide proper ground cover - reseed, fertilize, and mulch as needed.

SAMPLE SITE MAP

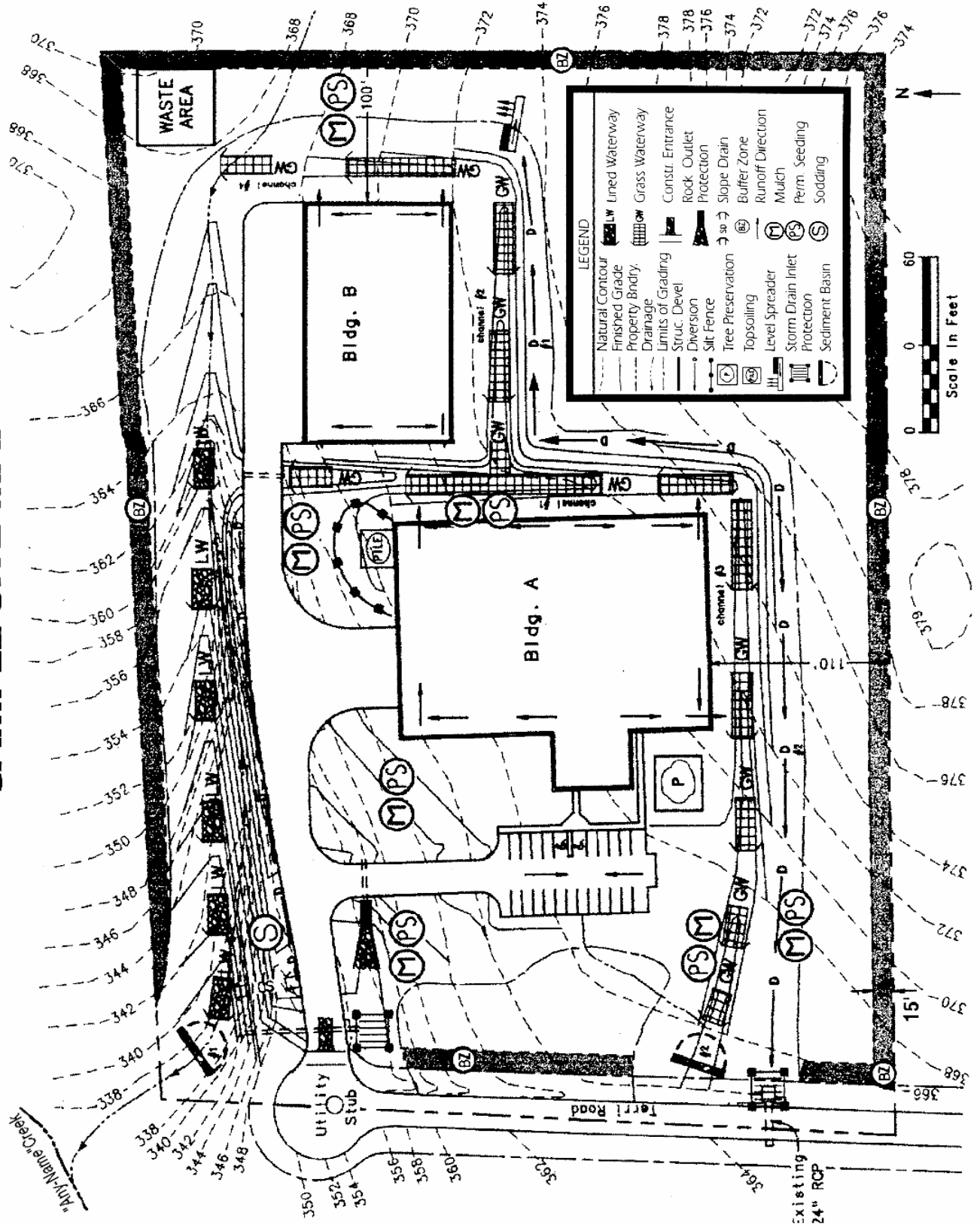

COMMON PLAN OF DEVELOPMENT OR SALE SWPPP REQUIREMENTS FOR INDIVIDUAL LOTS IN A RESIDENTIAL SUBDIVISION

When rain falls on exposed soil it can wash away valuable topsoil. It also carries soil, nutrients and other pollutants into streets, gutters and ditches, where it then travels to lakes, rivers, streams or wetlands. Polluted runoff can cause excessive growth of aquatic weeds and algae and reduce recreational opportunities such as swimming and fishing. Sediment laden runoff can also destroy fish habitat reducing productive fishing opportunities. In addition, sediment-laden runoff can also clog pipes, ditches, streams and basins resulting in increased flooding and maintenance cost. Therefore, the homebuilder is required to minimize off-site damage from soil erosion, sediment leaving the construction site, and poor "housekeeping" practices. This requirement must be accomplished by developing and implementing a Storm Water Pollution Prevention Plan (SWPPP). Some examples of individual lot SWPPPs are attached for your convenience. Sketch the controls on a copy of your site plan. Narrative notes on the site plan may also be used in addition to the erosion control symbols.

In developing and implementing the SWPPP, controls must be used from each control group (vegetative, structural, housekeeping) to prevent erosion and sediment and other pollutants from leaving the site. Commonly used controls include:

Vegetative Controls

Temporary vegetation includes annual grasses that sprout quickly such as annual rye, browntop millet, oats, and winter wheat. These grow quickly with little care and can protect the soil from rainfall and act as a filter. They will not provide permanent cover. Permanent cover must be established as soon as possible. When a disturbed area will be left undisturbed for thirty days or more, the appropriate temporary or permanent vegetative practices shall be implemented within seven calendar days.

Mulching is the placement of hay grass, woodchips, straw, or synthetic material on the soil to provide temporary cover to protect the soil from rain. Mulching may be the only option during the winter when seeding or sodding is not possible. Mulch must stay in place to be effective. Netting, stakes or chemical binders are used to anchor some types of mulch. Be sure to reinstall washed-out mulch and anchor if necessary until permanent cover is established.

Permanent stabilization is required as soon as possible. Silt fences, and other temporary measures must be removed following permanent stabilization. Establishing a permanent vegetative cover on disturbed areas using either sod, perennial seed, trees or shrubs is required. When a disturbed area will be left undisturbed for thirty days or more, the appropriate temporary or permanent vegetative practices shall be implemented within seven calendar days.

Vegetative buffer zones are undisturbed or planted vegetated areas that are between construction activities and water bodies.

Structural Controls

Silt fences are temporary sediment barriers made of filter fabric buried at the bottom, stretched, and supported by stakes. The silt fence slows runoff and allows it to puddle or pond, so soil and sediment can settle out before leaving the site. The bottom eight to twelve inches of fence must either be sliced in or buried in a trench about four to six inches deep by four to six inches wide. **Silt fences that are not buried are improperly installed. They have no useful function, are a waste of money, and may result in enforcement action.** Stakes must be on the downstream side of the fence and spaced about 3 feet apart. Silt fence must not be installed across streams, ditches, waterways, or other concentrated flow areas. Place fences on the contour or perpendicular to the slope of the hill so that water and sediment will pond behind the fence. **Turn ends uphill** to prevent water going around the end. Install on the downslope, downhill, downstream, or low side of your lot. Keep the fence/barrier in place until grass is established.

Construction entrance/exits are stone stabilized site entrances which reduce sediment tracked onto public roads. Apply gravel or crushed rock to the driveway area and restrict traffic to this one route. Use 3 to 6 inch gravel over a geotextile fabric. At the end of each day sweep or scrape up any soil tracked onto the

street. Limit "standard" vehicle access (including workers' vehicles) to only streets and roads, keep vehicles off of future yard areas; limit tracking of mud onto streets by requiring any required vehicles to use designated access drives. Streets are conduits for storm water, it is important to keep mud and sediment off the streets.

Stockpiles of sand or soil should be covered with plastic or tarps at the end of each workday, or surrounded with silt fence or haybales. Do not locate a stockpile near a street, storm drain inlet, or ditch.

Slope drains are piping or lined channels that carry storm water downslope without erosion. A good example would be a downspout extender. Extenders may be used to protect temporarily stabilized areas from roof runoff. Extenders can direct water from roof gutters to paved or grassed areas. Remove extenders following permanent stabilization.

Erosion control blankets or mats are machine-produced mats of straw or other fibers held together with netting that provide temporary or permanent stabilization in critical areas, such as slopes or channels, so that vegetation may be established.

Additional Controls: The above controls are the more common practices used at small construction sites. There are a number of other controls, techniques and manufactured product available. A few examples include hydro seeding, inlet protection devices, diversion berms, silt dikes and fiber logs. Even something as simple as a tarp or plastic may provide temporary cover for small exposed areas. You may wish to contact an erosion and sediment control specialist, local building official, or MDEQ for further information. In addition, MDEQ has several guidance manuals that may be of assistance and the internet has abundant guidance on construction BMPs.

Housekeeping Controls

Pollutants that may enter storm water from construction sites because of poor housekeeping include oils, grease, paints, gasoline, solvents, litter, debris, and sanitary waste. Good housekeeping practices include:

- Frequent cleaning of trash and debris, providing waste receptacles at convenient locations and providing regular collection of waste;
- Directing concrete trucks to the subdivision's designated wash-off area(s) or back to the Ready-Mix facility;
- Providing protected storage areas for chemicals, paints, solvents, fertilizers, and other potentially toxic materials; and
- Providing adequately maintained sanitary facilities.

In addition, you should be aware that State air regulations prohibit the open burning of residential solid waste.

EXAMPLE INDIVIDUAL LOT SITE MAPS

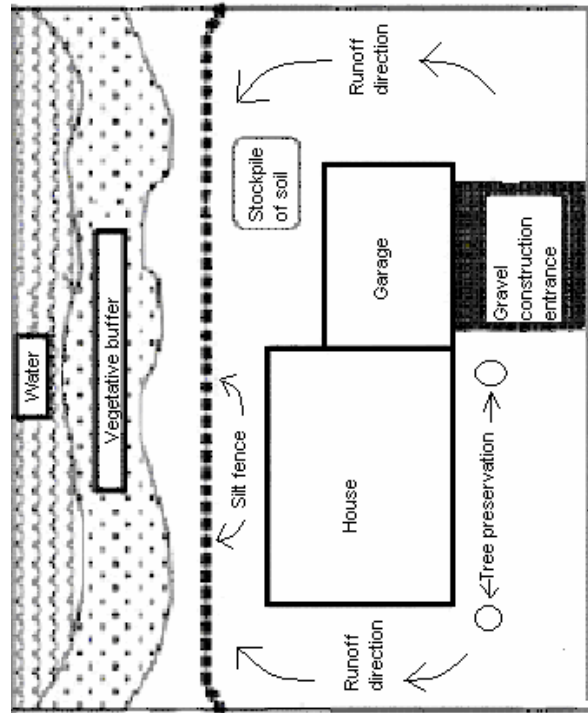
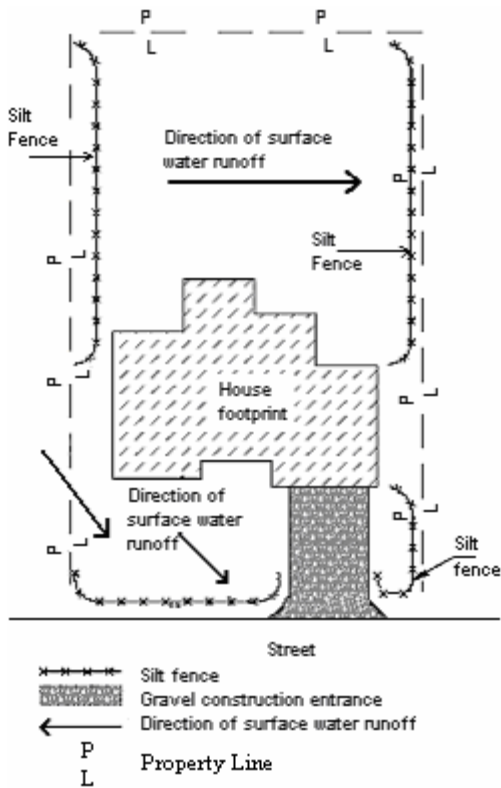
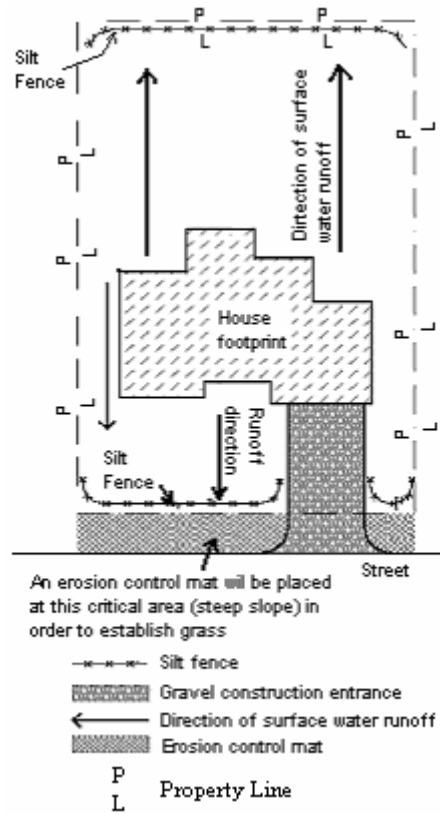
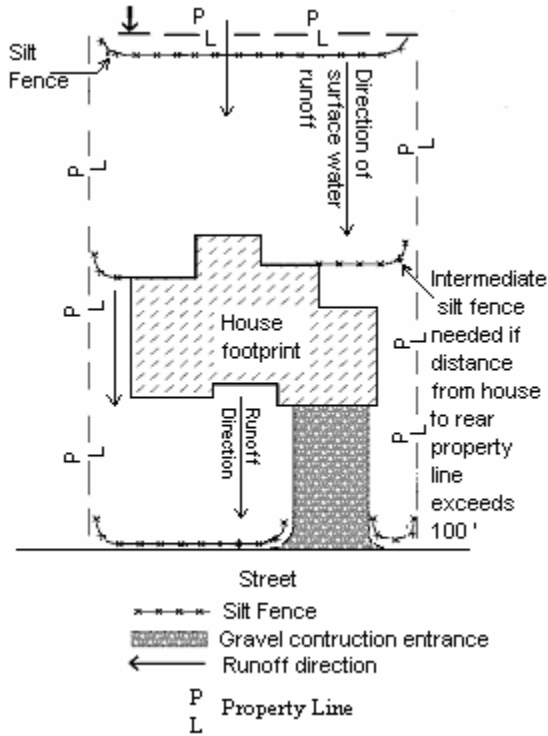

All disturbed areas will be temporarily seeded with ryegrass. After final grade has been reached, all disturbed areas will be sodded with bermuda grass.

Worksheet 1 - Checklist Sheet for Erosion and Sediment Controls

To aid in choosing all needed controls, check off practices to be used. Describe in SWPPP and show locations on site map.

STRUCTURAL PRACTICES

- | | |
|---|---|
| <input type="checkbox"/> Check Dam | <input type="checkbox"/> Construction Entrance/Exit |
| <input type="checkbox"/> Diversion | <input type="checkbox"/> Storm Drain Inlet Protection |
| <input type="checkbox"/> Level Spreader | <input type="checkbox"/> Lined Waterway |
| <input type="checkbox"/> Slope Drains | <input type="checkbox"/> Rip-Rap Outlet Protection |
| <input type="checkbox"/> Sediment Basin | <input type="checkbox"/> Silt Fence |
| <input type="checkbox"/> Slope Breaks | <input type="checkbox"/> Straw Bale Barrier |
| <input type="checkbox"/> Other Controls _____ | |

VEGETATIVE PRACTICES

- | | |
|---|--|
| <input type="checkbox"/> Mulching | <input type="checkbox"/> Permanent Seeding |
| <input type="checkbox"/> Protection of Trees | <input type="checkbox"/> Surface Roughening |
| <input type="checkbox"/> Sod Stabilization | <input type="checkbox"/> Temporary Seeding |
| <input type="checkbox"/> Tree Preservation | <input type="checkbox"/> Tillage, with Lime and Fertilizer |
| <input type="checkbox"/> Vegetative Buffer Strips | |
| <input type="checkbox"/> Other Controls _____ | |

CONTROLS FOR INDIVIDUAL LOTS IN SUBDIVISIONS

- | | |
|--|--|
| <input type="checkbox"/> Subdivision Covenants | <input type="checkbox"/> Lot Purchase Contract |
| <input type="checkbox"/> Local Ordinance | <input type="checkbox"/> Architectural Review Requirements |
| <input type="checkbox"/> Other Controls _____ | |

HOUSEKEEPING PRACTICES

- | | |
|---|--|
| <input type="checkbox"/> Areas for maintenance and repair | <input type="checkbox"/> Waste receptacles |
| <input type="checkbox"/> Storage for toxic materials | <input type="checkbox"/> Sanitary facilities |
| <input type="checkbox"/> Other Controls _____ | |

POST CONSTRUCTION CONTROL MEASURES

- | | |
|--|---|
| <input type="checkbox"/> Detention Basin | <input type="checkbox"/> Retention Pond |
| <input type="checkbox"/> Wetlands | <input type="checkbox"/> Velocity Dissipation Devices |
| <input type="checkbox"/> Vegetated Swales
and Natural Depressions | |
| <input type="checkbox"/> Other Controls _____ | |

FREQUENTLY ASKED QUESTIONS

Q. Are there any fees associated with CNOI applications or permit coverage?

A. No. The MDEQ general permits do not require a fee at this time.

Q. What should I do if my general permit coverage expires and my project has not been completed?

A. If the permit is reissued or replaced with a new one before the current one expires, you will need to comply with whatever conditions the new permit requires in order to transition coverage from the old permit. This usually includes submitting a re-coverage form that will be sent to you along with a letter of instruction and a copy of the reissued general permit. The MDEQ will contact you when a new permit is issued. You do not need to do anything until you are contacted.

Q. What is a SWPPP?

A. This acronym stands for Storm Water Pollution Prevention Plan. For construction activities, it is a plan which describes appropriate practices which will reduce or mitigate sediment from leaving the construction site - "an erosion and sediment control plan".

Q. Where can I get assistance?

A. If you don't have the expertise - hire an engineer or consultant who has knowledge of erosion and sediment control. Private land owners may go to the Natural Resource Conservation Service (NRCS).

Q. How do I terminate a project?

A.1. Within 30 days of final stabilization for a covered project, a completed Notice of Termination (NOT) of Coverage form (provided in the Large Construction Forms Package) shall be submitted to the Permit Board. The MDEQ staff will inspect the site, and if no erosion or sediment control problems are identified and adequate permanent controls are established, the owner or operator will receive a letter of termination from the MDEQ.

A.2. The coverage recipient of a "larger common plan of development or sale" must submit a NOT within 30 days after the following conditions are met:

(1) Final stabilization has been achieved on all portions of the site for which the coverage recipient is responsible, and

(2) Other owners or operators have assumed control over all areas of the site that have not achieved final stabilization.

A.3. The coverage recipient of a residential "larger common plan of development or sale" must submit a copy of the MDEQ Registration Form for each lot sold with the NOT.

A.4. Residential lot owners or operators that have completed the MDEQ Registration Form are not required to submit a NOT, unless specifically requested by the MDEQ staff. The lot permit coverage is considered terminated upon successful completion of all permanent erosion and sediment controls.

Q. What is the threshold of land disturbance that will require me to obtain storm water permit coverage?

A.1. Projects that are considered to be Large Construction are: land disturbing activities of five (5) acres or greater; or for land disturbing activities that are part of a larger common plan of development or sale that will disturb five (5) or more acres.

A.2. Projects that are considered to be Small Construction are: land disturbing activities of one (1) acre to less than five (5) acres; or for land disturbing activities less than one (1) acre that are part of a larger common plan of development or sale that will disturb one (1) to less than five (5) acres.

Q. What is meant by a “larger common plan of development or sale?”

A. A “larger common plan of development or sale” is a contiguous area where multiple separate and distinct construction activities may be taking place at different times on different schedules under one plan. For example, if a developer buys a 20-acre lot and builds roads, installs pipes, and runs electricity with the intention of construction homes or other structures sometime in the future, this would be considered a common plan of development or sale. If the land is parceled off or sold, and construction occurs on plots that are less than five acres by separate, independent builders, this activity still would be subject to storm water permitting requirements if the smaller plots were included on the original site plan.

Q. For projects such as a 100-mile pipeline project, what location should be provided on the CNOI?

A. The beginning of a linear construction project should be used as the location and all counties that the project traverses should be listed on the MDEQ’s CNOI Form.

Q. Is clearing of lands specifically for agricultural purposes regulated construction activity (40 CFR 122.26(b)(14)(x)) under the storm water program?

A. No. Although the clearing of land may be greater than five acres, any amount of clearing for agricultural purposes is not considered an industrial activity under the storm water regulations. Section 402(l)(1) of the 1987 Water Quality Act exempts agricultural storm water discharges from NPDES permitting requirements including storm water permitting. This exemption only applies, however, if the clearing of land is solely for agricultural purposes. For example, the clearing of land for the purpose of building a retail store would require permitting.

Q. If a construction activity that disturbs less than one acre occurs at a regulated industrial activity currently covered by the State’s industrial storm water permit, does the regulated industry have to modify its pollution prevention plan to include controls for the area of construction?

A. Yes. Regulated industrial activities covered by Mississippi’s storm water industrial general permits must revise their pollution prevention plan to address all new sources of pollution and runoff including those from construction activities disturbing less than one acre, that occurred on the site of the regulated industry. If the disturbance is five acres or greater then the facility should submit a CNOI for coverage under the States’s construction storm water general permit.

Q. For a construction activity that uses off site “borrow pits” for excavation of fill material or sand and gravel, should the number of disturbed acres at the borrow pit be added to the number of acres at the construction site to determine the total number of disturbed acres?

A. No, off site borrow pits are not considered part of the on site construction activity. If a borrow pit is specifically used for the removal of materials such as sand, gravel, and clay, the pit is considered a mine and is classified under SIC code 14. Such sites would be regulated as industrial activity as defined at 40 CFR 122.26(b)(14)(iii).

Q. Who must apply for permit coverage for construction activities?

A. Under the Mississippi storm water program, the owner or operator of a regulated activity or discharge must apply for storm water permit coverage. The operator of a construction activity is the party or parties that either individually or taken together meet the following two criteria: (1) they have operational control over the site specifications (including the ability to make modifications in specifications); and (2) they have the day-to-day operational control of those activities at the site necessary to ensure compliance with plan requirements and permit conditions (9/9/92 Federal Register page 41190). Usually the owner of the project initially files the CNOI and the contractor would complete and submit the "prime contractor form" when selected.

Q. Who is responsible for permit compliance?

A. The owner and the operator have joint and severable liability for permit compliance.

Q. Does construction activity encompass repaving of roads?

A. Repaving is not regulated under the large construction storm water general permit unless five or more acres of underlying and/or surrounding soil is cleared, graded or excavated as part of the repaving operation.

Q. Does construction activity encompass routine road maintenance?

A. No. Construction activity does not include routine maintenance that is performed to maintain the original line and grade, hydraulic capacity, or original purpose of the site.

Q. Are long-term maintenance programs for flood control channels (such as vegetation removal) or similar roadside maintenance programs subject to permitting if five or more acres are disturbed?

A. If grading, clearing or excavation activities disturb one or more acres of land either for an individual project or as part of a long-term maintenance plan, then the activity is subject to storm water permit application requirements.

Q. Would building demolition constitute a land disturbing activity and require a storm water construction permit application?

A. The definition of land disturbing activity includes but is not limited to clearing, grading and excavation. At a demolition site, disturbed areas might include where building materials, demolition equipment, or disturbed soil are situated, which may alter the surface of the land. Therefore, demolition activities that disturb five or more acres of land would be subject to storm water construction permit application requirements.

Q. Do storm water construction general permits authorize non-storm water discharges?

A. The following non-storm water discharges are authorized: discharges from fire-fighting activities, fire hydrant flushing, water used to control dust, potable water including uncontaminated water line flushing, routine external building wash down that does not use detergents, pavement wash waters where spills or leaks of toxic or hazardous materials have not occurred (unless all spilled material has been removed) and where detergents are not used, uncontaminated air conditioning or compressor condensate, uncontaminated ground water or spring water, foundation or tooting drains where flows are not contaminated with process materials such as solvents, uncontaminated excavation dewatering, landscape irrigation. However, they must be included in the SWPPP and addressed by the appropriate BMP.

ORDER TODAY!

The State of Mississippi's

Planning & Design Manual for the Control of Erosion, Sediment & Stormwater

A technical guidance manual for the control of erosion, sediment, and stormwater from nonpoint sources (NPS) and for the preparation of erosion, sediment, and stormwater control plans.

*A Cooperative Effort by:

- The Mississippi Department of Environmental Quality
- Mississippi Soil and Water Conservation Commission
- USDA Soil Conservation Service

COST PER COPY

\$20

(Includes Shipping & Handling)

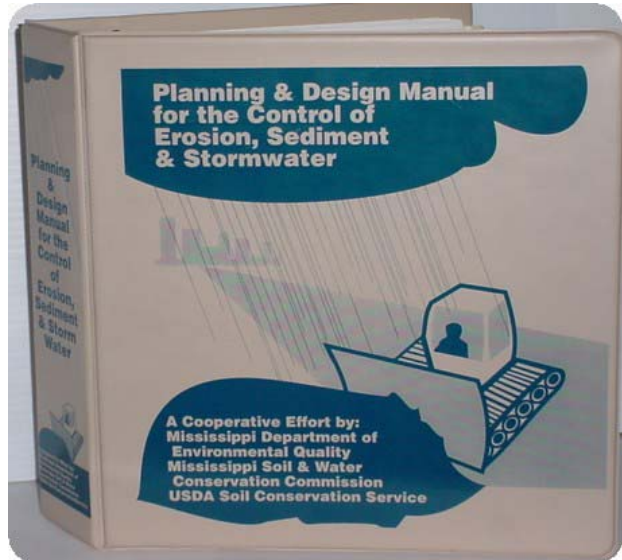

This guidance manual includes:
5171

Contact Ann Porter at (601) 961-

- **Ch. 1. Planning and Design Manual Introduction**
What is a best management practice?
- **Ch. 2. Erosion, Sediment and Stormwater Control Plan Guidance**
- **Ch. 3. Overview of Erosion, Sediment, and Stormwater Control Practices (BMPs)**
Over 42 color photographs of control practices!
- **Ch. 4. Best Management Practice Standards**
Temporary and Permanent Practices.
- **Ch. 5. Vegetative Practice Standards**
- **Ch. 6. Hydrology**
Procedures for determining peak watershed discharge.
- **Ch. 7. Sample Erosion, Sediment and Stormwater Control Plan**
- **Ch. 8. References**

TO ORDER A COPY OF THIS MANUAL, DETACH AND RETURN THIS PORTION ALONG WITH A CHECK OR MONEY ORDER PAYABLE TO:

**The Mississippi Department of Environmental Quality
P.O. Box 20305
Jackson, Mississippi 39289-1305**

FOR OFFICE USE ONLY:

Date Payment Received

Date Manual Shipped

NAME: _____

ADDRESS: _____

CITY: _____ **STATE:** _____ **ZIP CODE:** _____

PHONE #: () _____

Number of Manuals Ordered: _____ Total Amount Enclosed: _____