

TYPICAL JAMB DETAIL, (EXTERIOR)
NOT TO SCALE

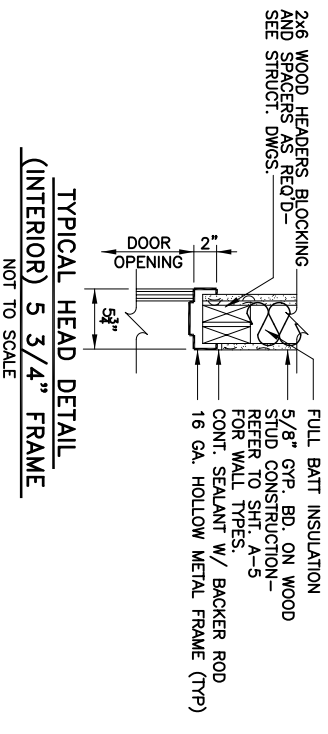

TYPICAL HEAD DETAIL (INTERIOR) 5 3/4\"
NOT TO SCALE

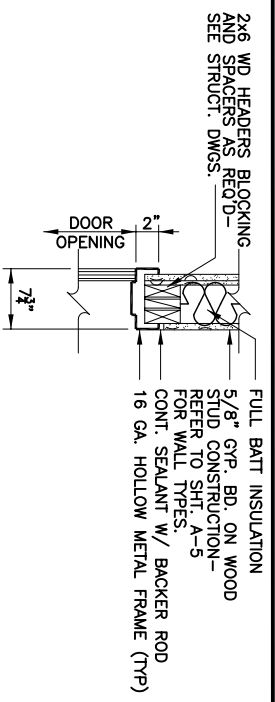

TYPICAL JAMB DETAIL (INTERIOR) 7 3/4\"
NOT TO SCALE

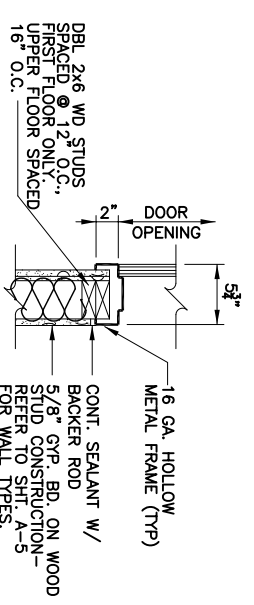

TYPICAL HEAD DETAIL (INTERIOR) 5 3/4\"
NOT TO SCALE

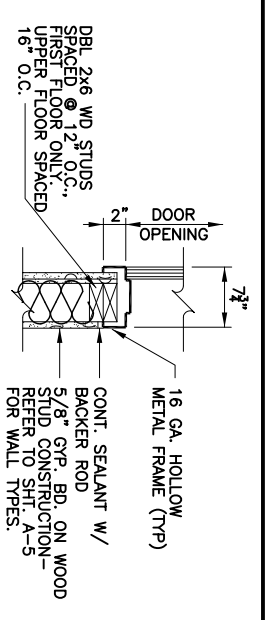

TYPICAL JAMB DETAIL (INTERIOR) 7 3/4\"
NOT TO SCALE

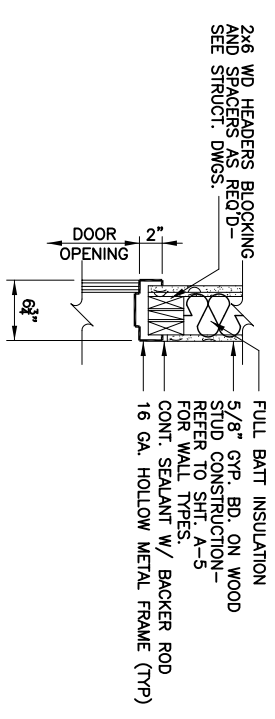

TYPICAL HEAD DETAIL (INTERIOR) 6 3/4\"
NOT TO SCALE

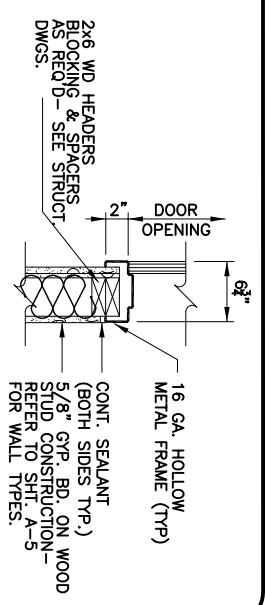

TYPICAL JAMB DETAIL (INTERIOR) 6 3/4\"
NOT TO SCALE

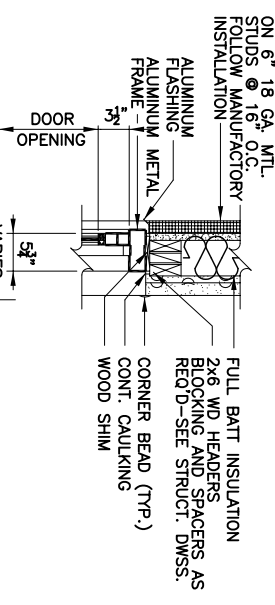

TYPICAL HEAD DETAIL, (EXTERIOR) (VARIOUS WIDTHS)
NOT TO SCALE

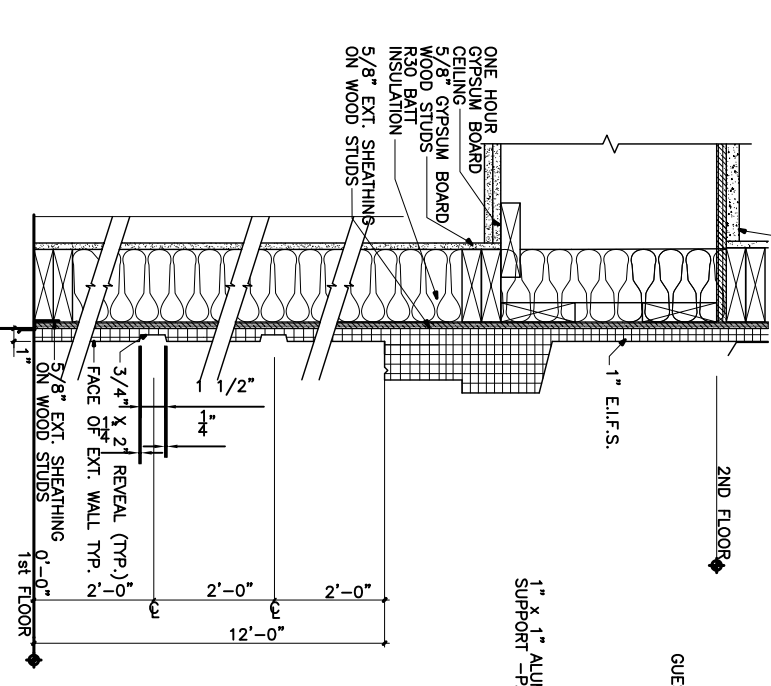

DECORATIVE BANDING @ 1st FLOOR
NOT TO SCALE

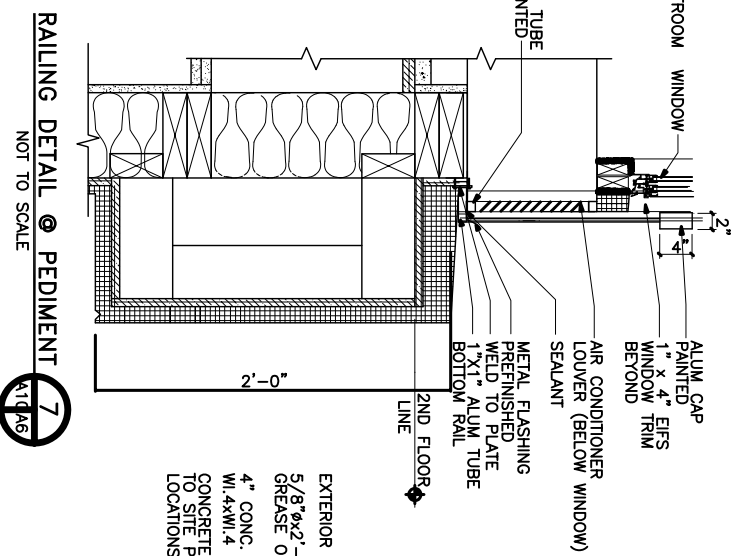

RAILING DETAIL @ PEDIMENT
NOT TO SCALE

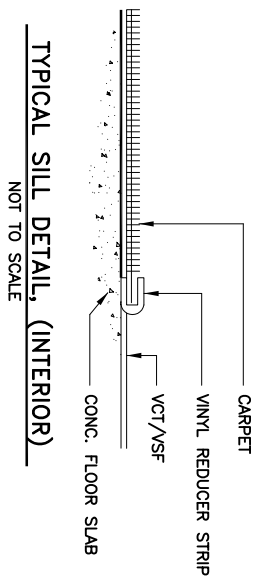

TYPICAL SILL DETAIL, (INTERIOR)
NOT TO SCALE

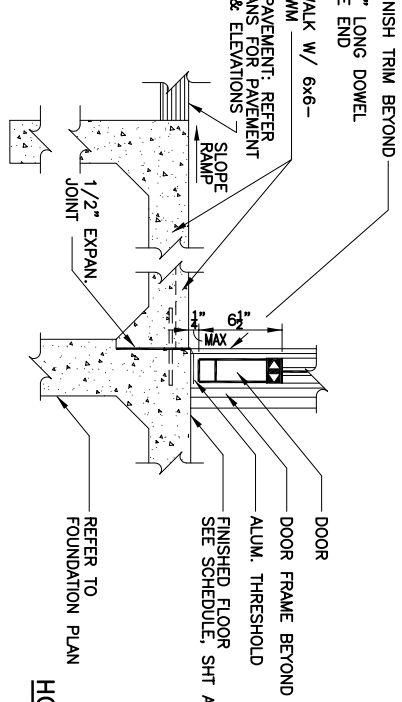

TYPICAL SILL DETAIL, (EXTERIOR)
NOT TO SCALE

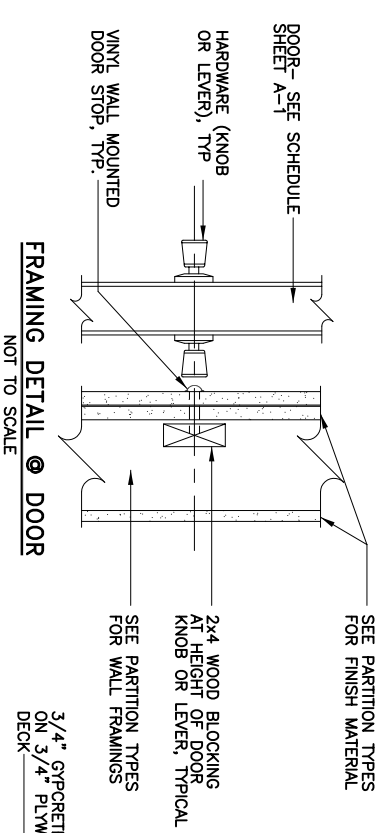

FRAMING DETAIL @ DOOR
NOT TO SCALE

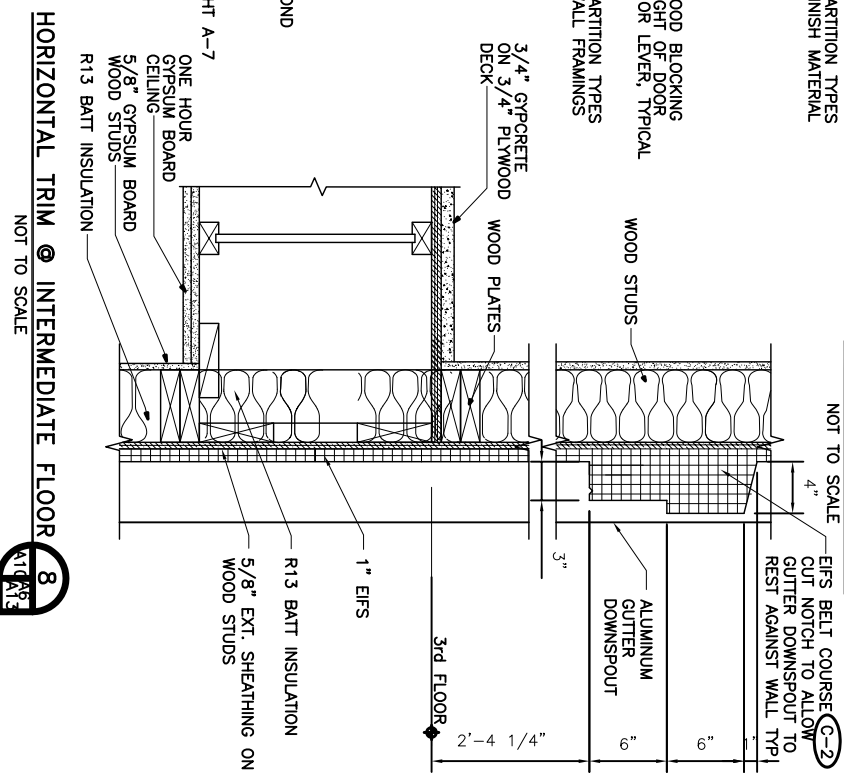

HORIZONTAL TRIM @ INTERMEDIATE FLOOR
NOT TO SCALE

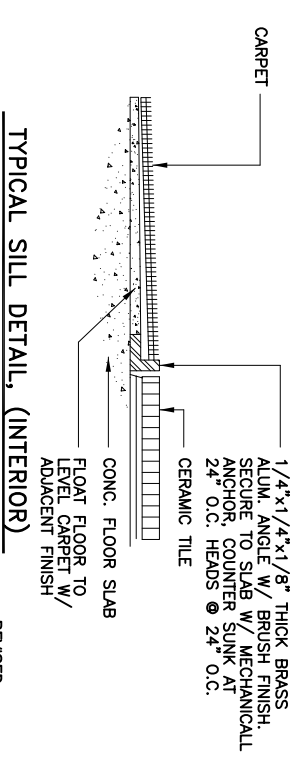

TYPICAL SILL DETAIL, (INTERIOR)
NOT TO SCALE

- GENERAL NOTES:**
1. ALL METAL FRAMES ARE TO BE KNOCK DOWN TYPE FRAME.
 2. 1-HOUR FIRE BARRIER SEPARATION DOOR AND FRAME ASSEMBLIES WILL HAVE SELF CLOSING LABELED 45 MIN. DOOR FRAME, 101:16 32.

- REVISIONS:**
- | | | |
|---|-------|--------------------------------------|
| 8 | 11/13 | HORIZONTAL TRIM @ INTERMEDIATE FLOOR |
| 9 | 11/16 | DECORATIVE BANDING @ 1st FLOOR |

DOOR DETAILS
DR. EDUARDO HERNANDEZ
CEDAR LAKE ROAD
BILOXI, MISSISSIPPI

LA QUINTA INN & SUITES
DAMMON ENGINEERING, INC.
1095 FLORIDA AVENUE 985-649-5832 SLIDELL, LA. 70458
DAMMONENGINEERING.COM

SCALE: 3/4"=1'
FILE:
JOB NO. 1694
DATE: 11-01-05
SHEET
A.10
OF