

GENERAL NOTES:

1. FOLLOW KE-1 AND KE-2 FOR PLUMBING AND ELECTRICAL EQUIPMENT ROOM-IN-LOCATIONS FOR EQUIPMENT SIZING.
2. ALL SHELVING TO BE MOUNTED AT 5'-8" A.F.F. UNLESS NOTED OTHERWISE.
3. EQUIPMENT REFERENCED ON THIS DRAWING ARE ITEMS REFERENCED ON THE OTHER GENERAL CONTRACT DRAWINGS.
4. REFER TO ROOM FINISH SCHEDULE FOR WALL FINISHES.
5. STAINLESS STEEL CORNER PROTECTORS WILL BE PROVIDED BY THE GENERAL CONTRACTOR.
6. FOLLOW REQUIREMENTS ON A-1 FOR WOOD BLOCKING.
7. WHEN BACK-UP CO2 TANK IS REQUIRED, CONTRACTOR SHALL PROVIDE AND INSTALL WITH ALL NECESSARY LAB BOLTS TO PREVENT OVERTURNING.

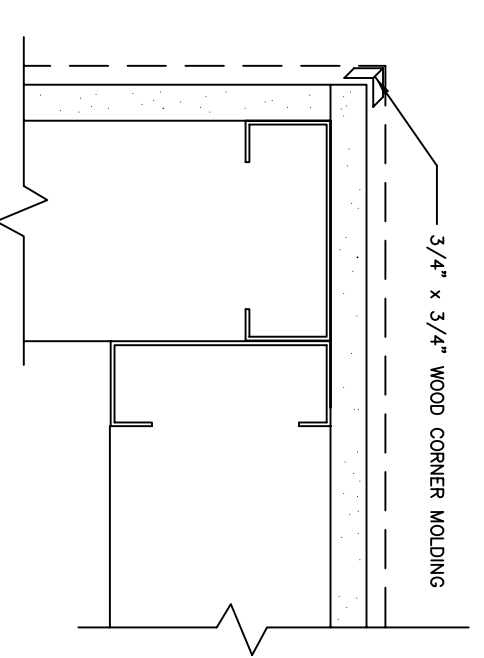

2 CORNER MOLDING DETAIL
SCALE: 3" = 1'-0"

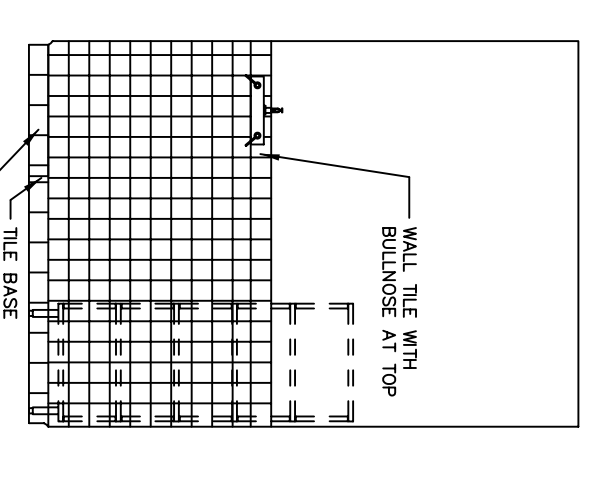

52 CHEM. ROOM
SCALE: 3/8" = 1'-0"

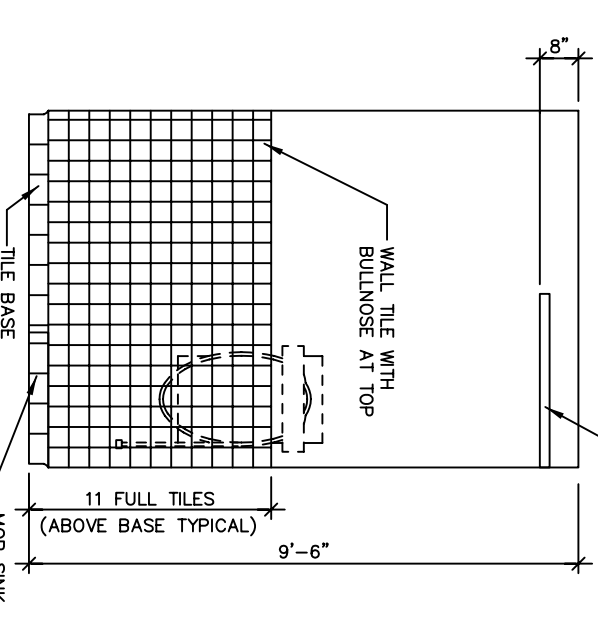

53 CHEM. ROOM
SCALE: 3/8" = 1'-0"

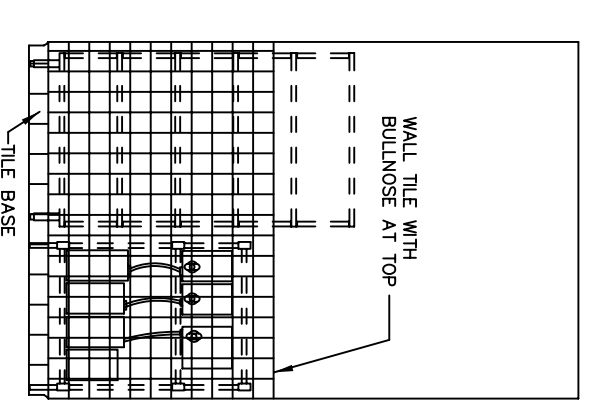

54 CHEM. ROOM
SCALE: 3/8" = 1'-0"

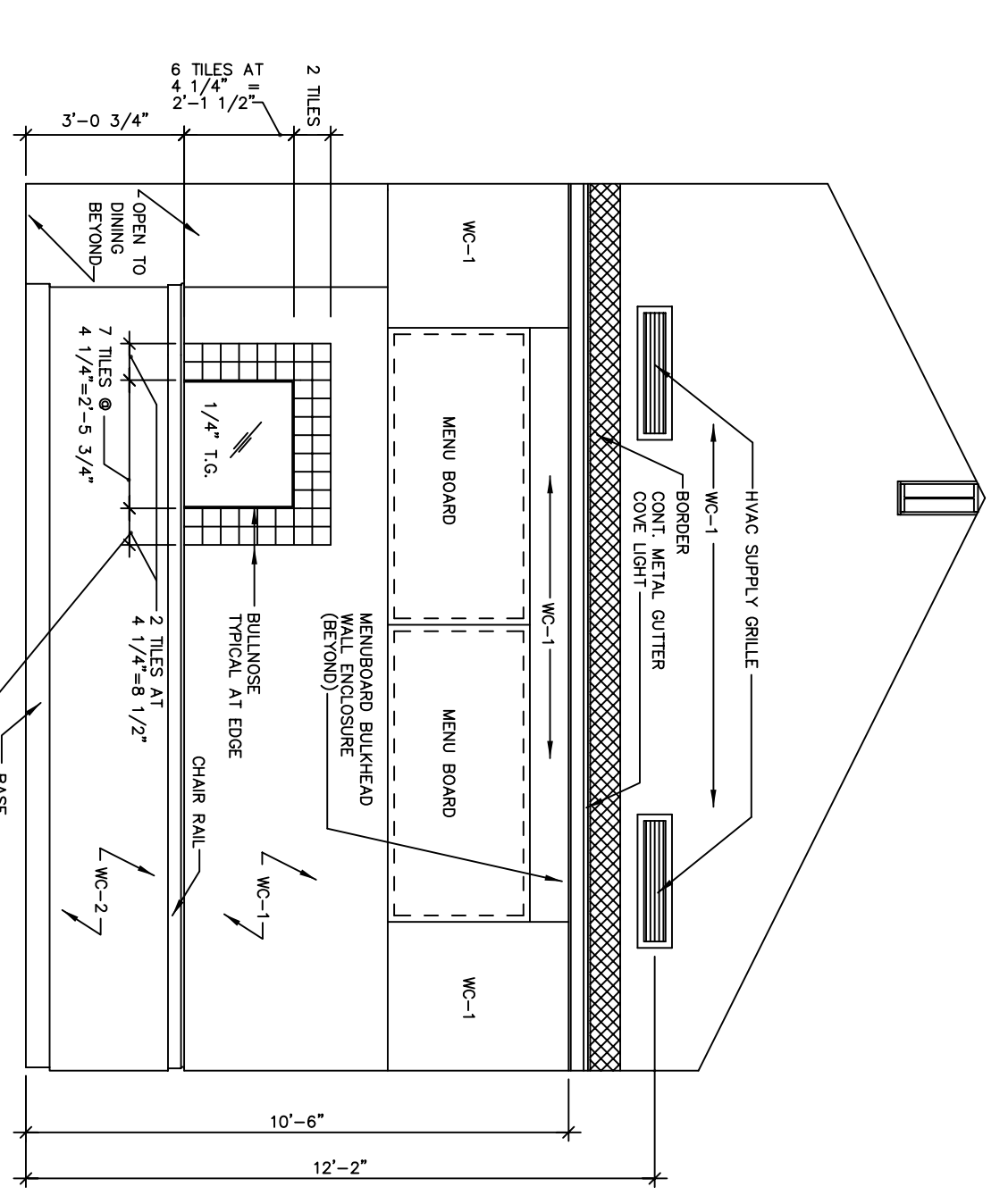

55 WAITING AREA
SCALE: 3/8" = 1'-0"

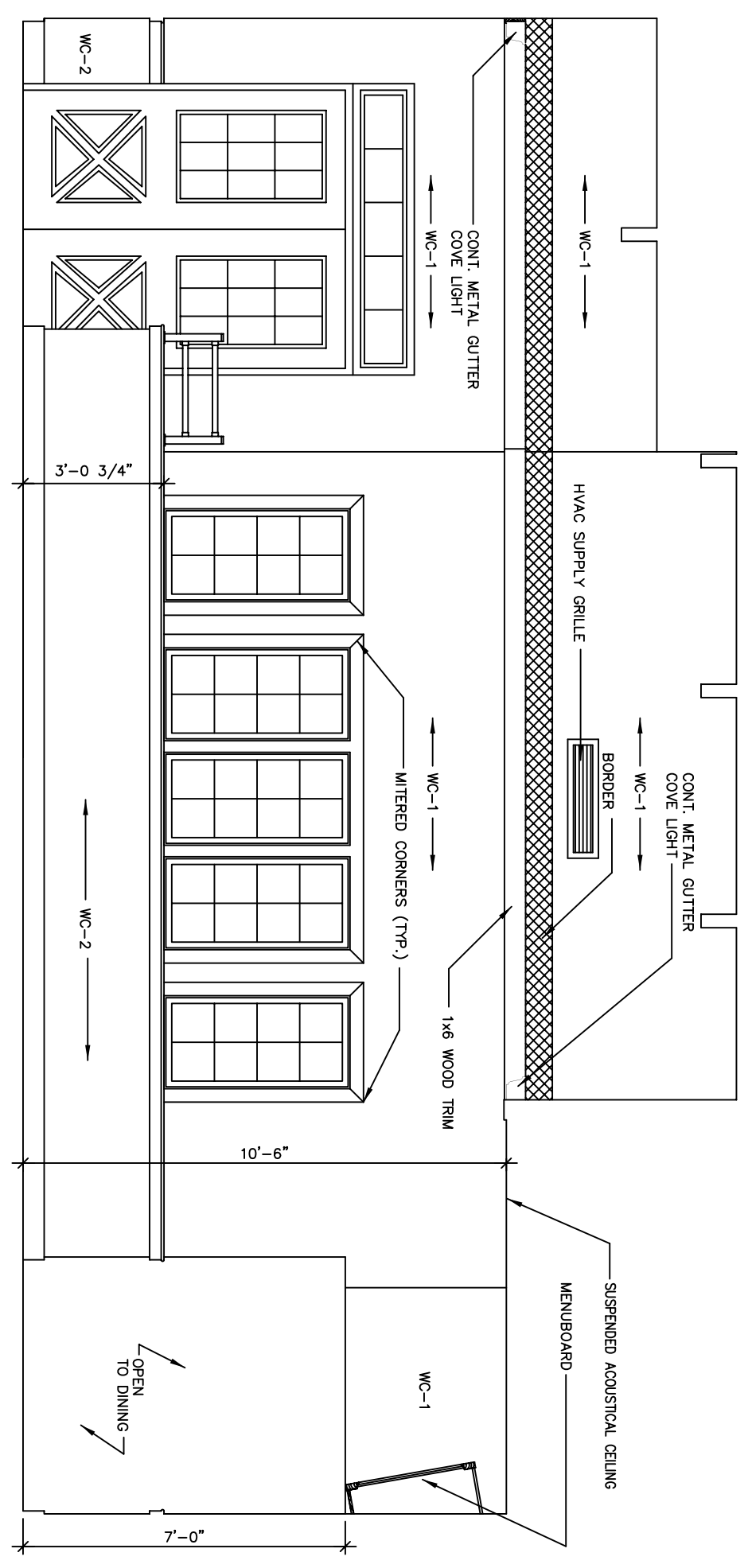

56 WAITING AREA
SCALE: 3/8" = 1'-0"

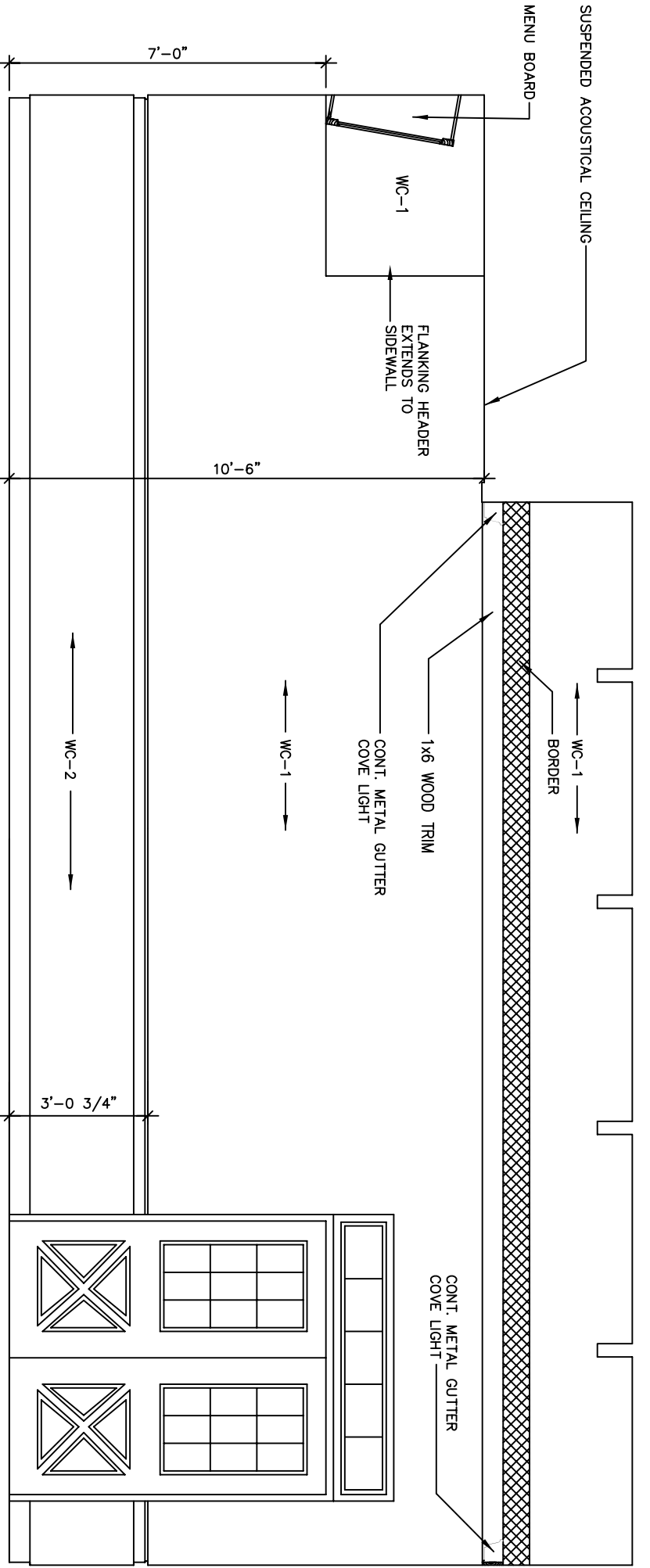

57 WAITING AREA
SCALE: 3/8" = 1'-0"

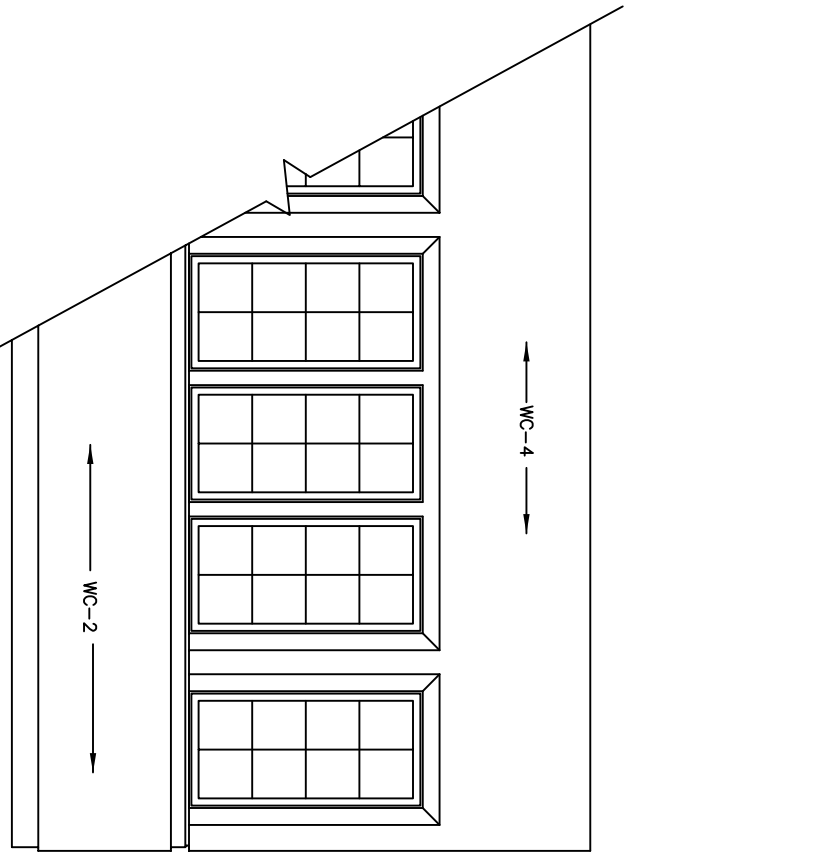

57A DINING AREA
SCALE: 3/8" = 1'-0"

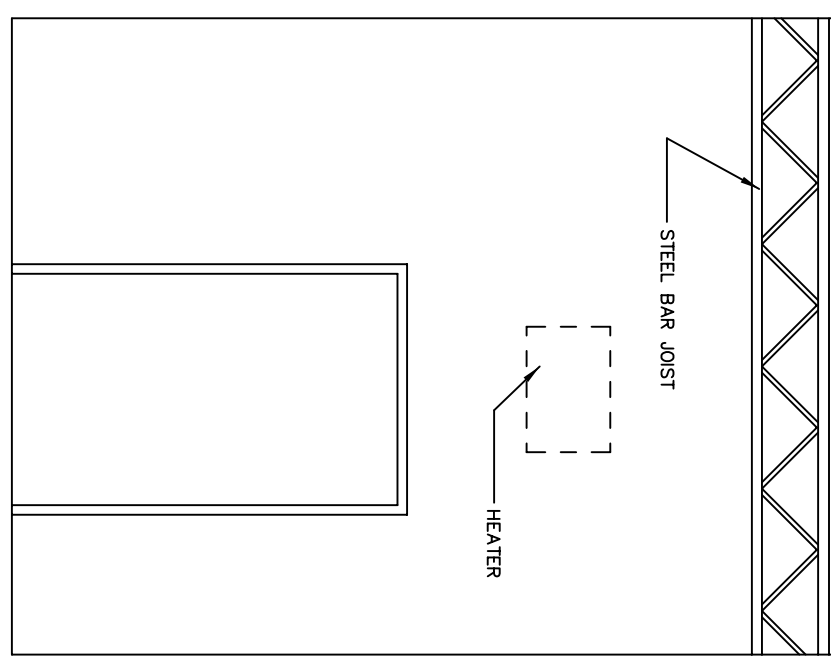

58 MECH. ROOM
SCALE: 3/8" = 1'-0"

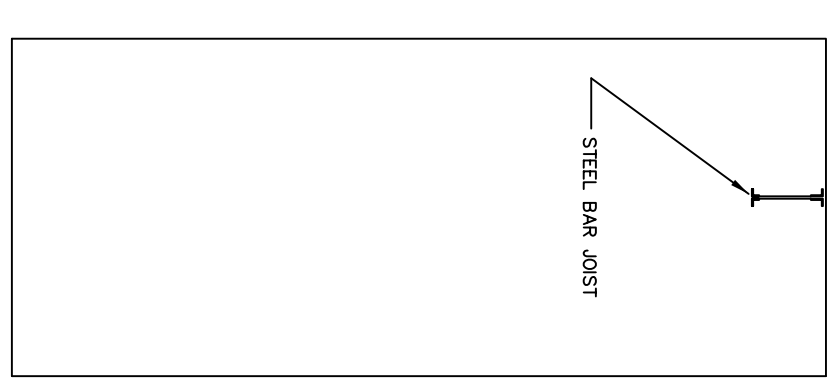

59 MECH. ROOM
SCALE: 3/8" = 1'-0"

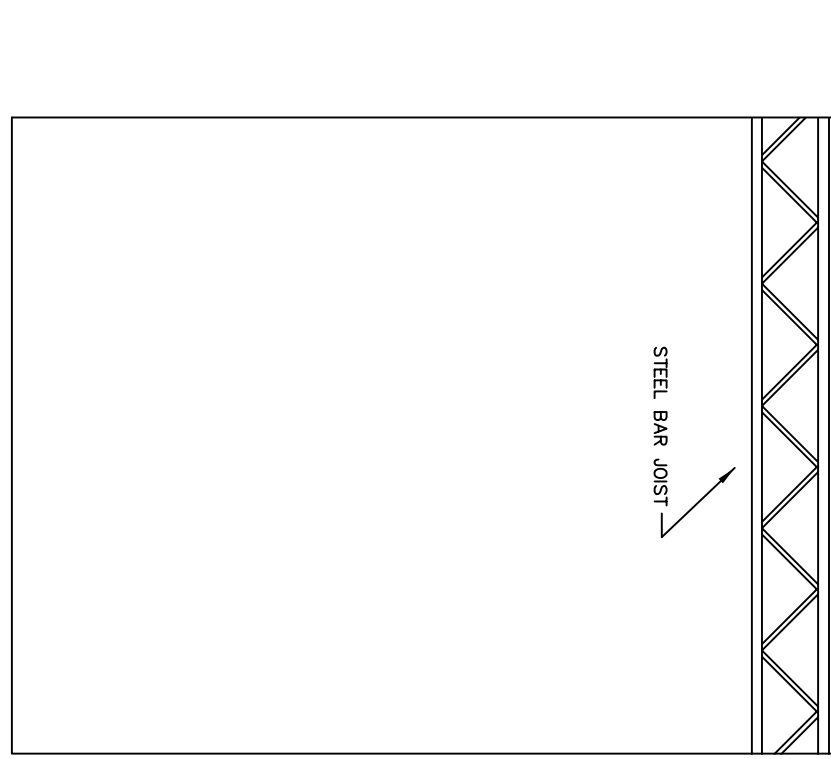

60 MECH. ROOM
SCALE: 3/8" = 1'-0"

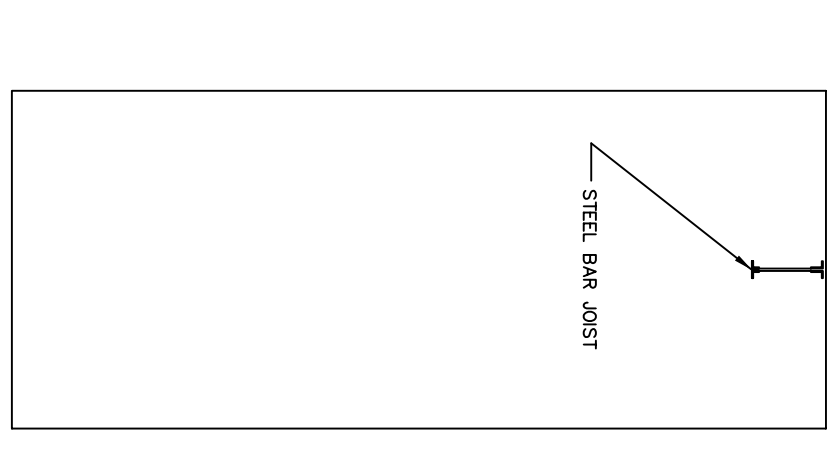

61 MECH. ROOM
SCALE: 3/8" = 1'-0"

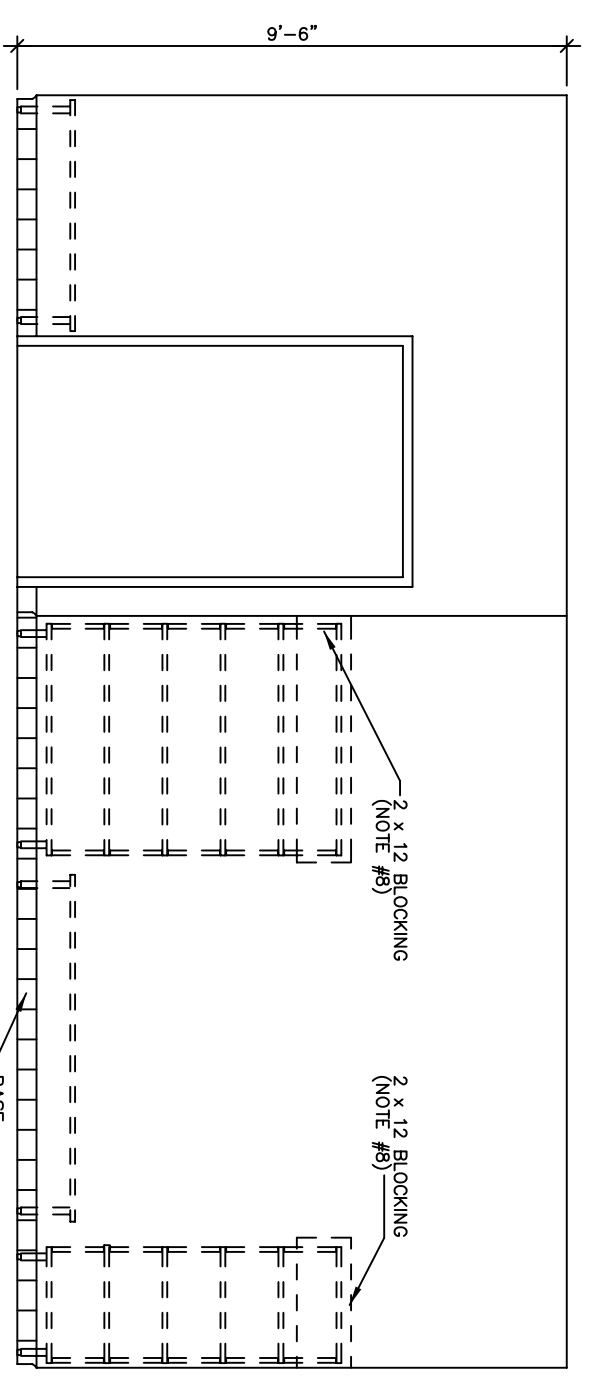

62 DRY STORAGE
SCALE: 3/8" = 1'-0"

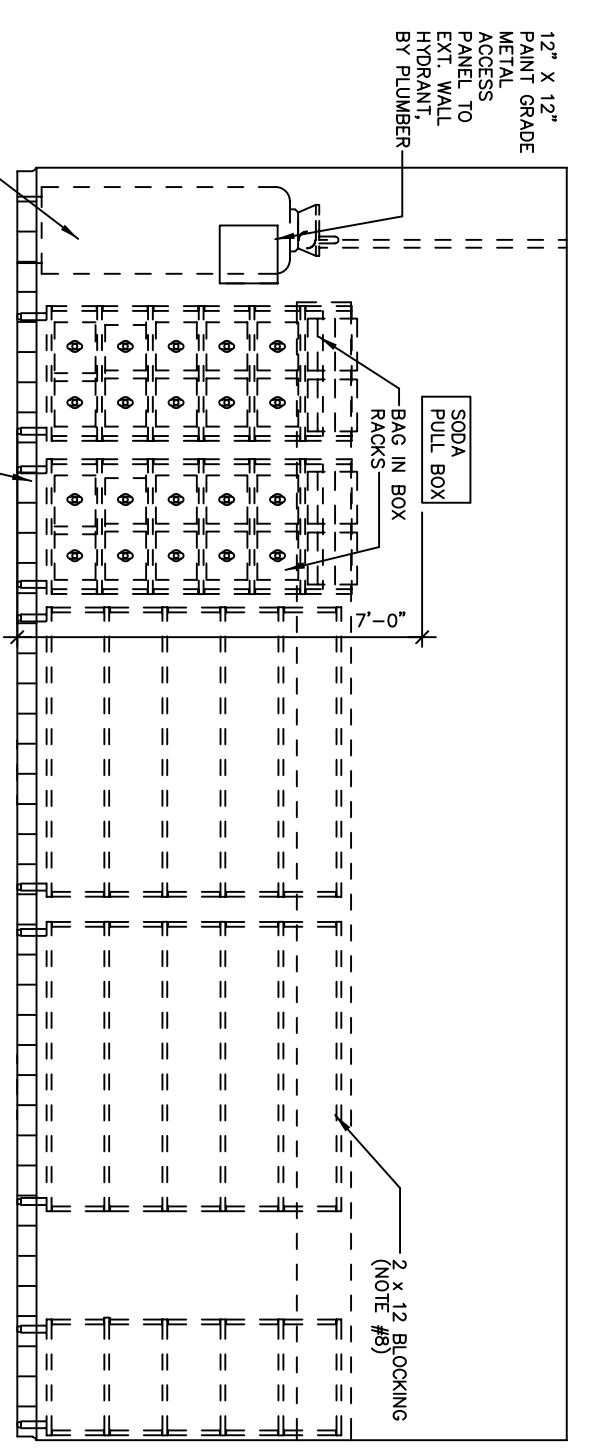

63 DRY STORAGE
SCALE: 3/8" = 1'-0"

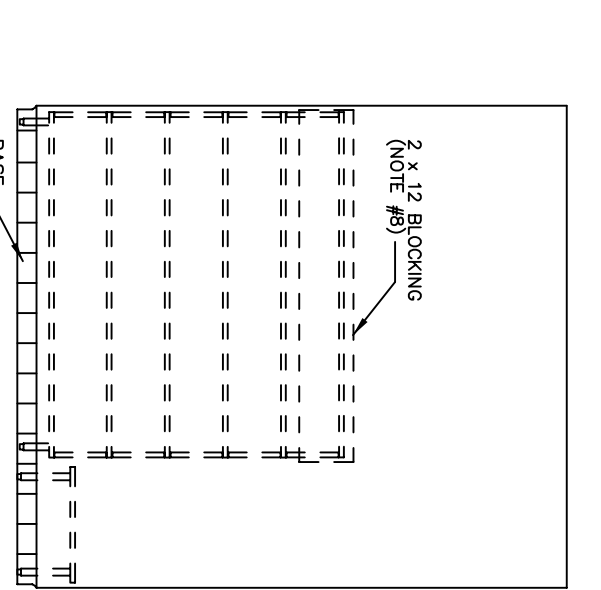

64 DRY STORAGE
SCALE: 3/8" = 1'-0"

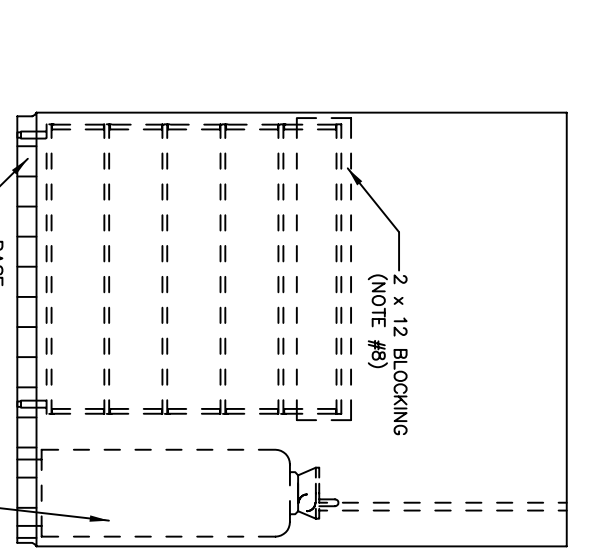

65 DRY STORAGE
SCALE: 3/8" = 1'-0"

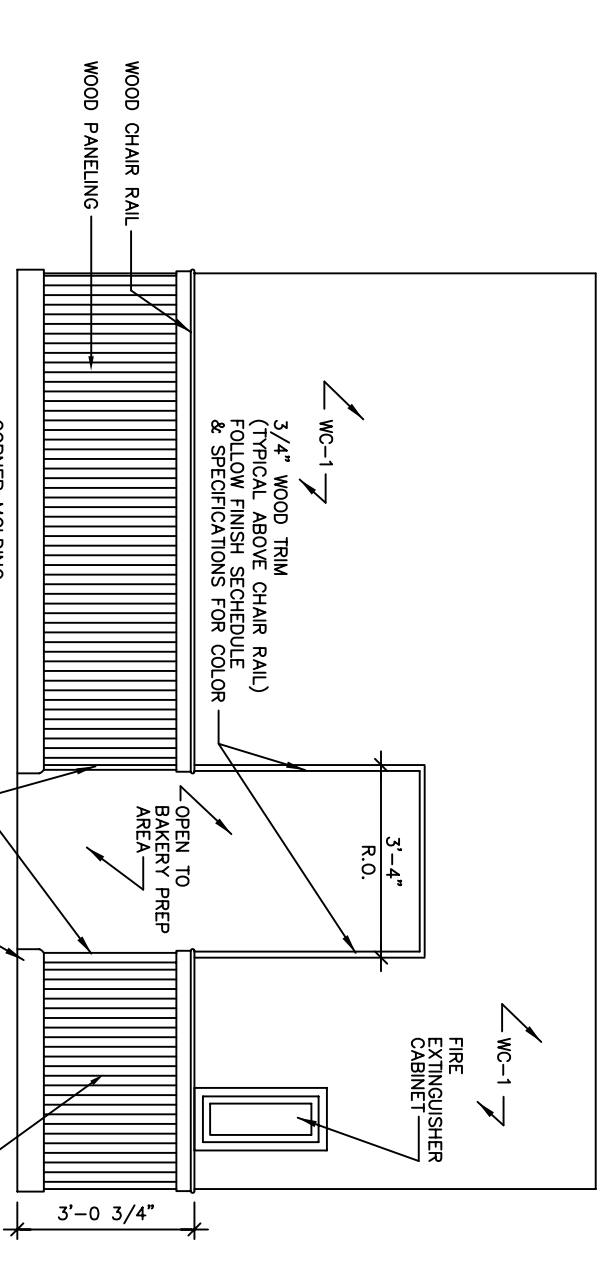

66 DINING AREA
SCALE: 3/8" = 1'-0"

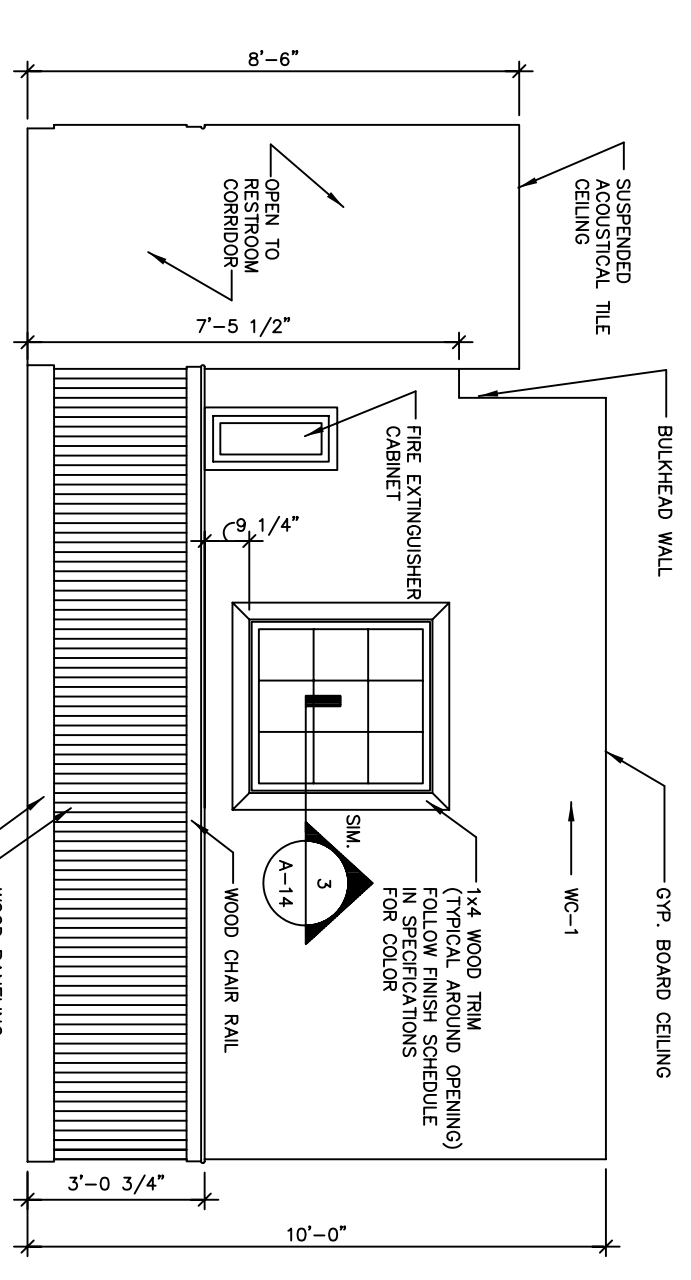

67 DINING AREA
SCALE: 3/8" = 1'-0"

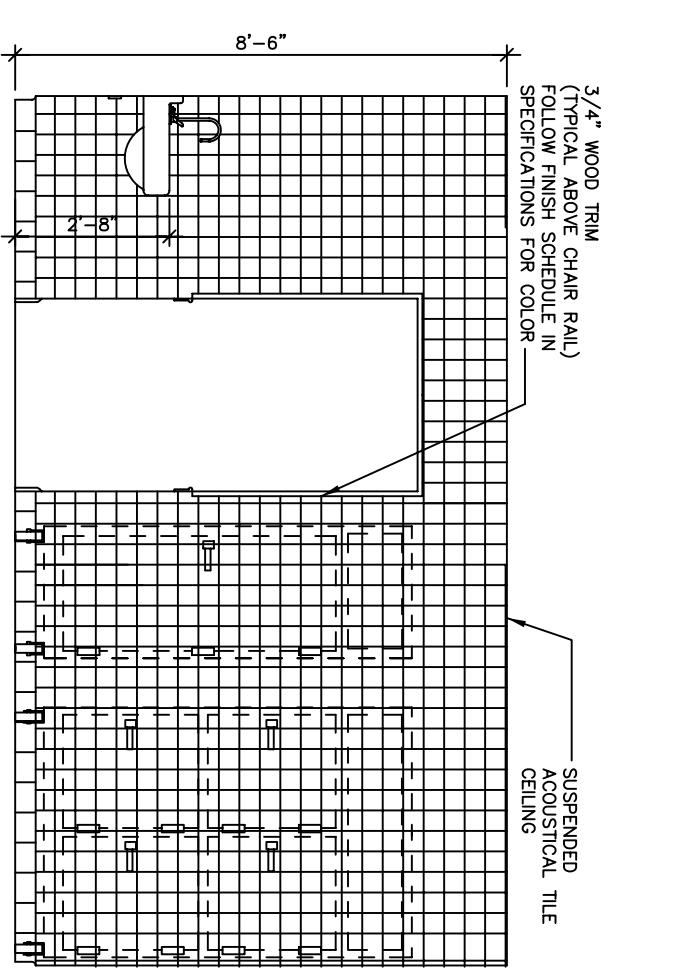

68 BAKERY PREP. AREA
SCALE: 3/8" = 1'-0"

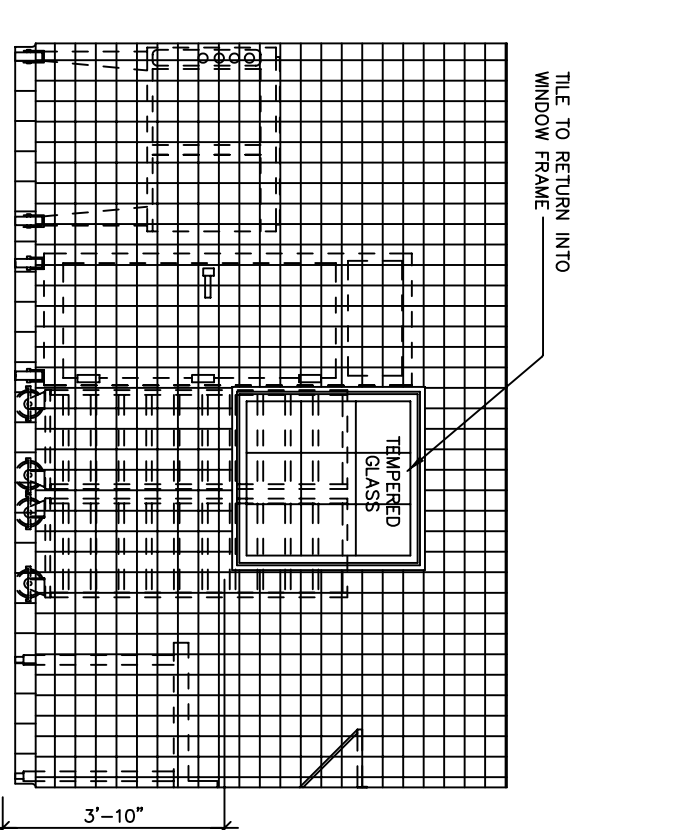

69 BAKERY PREP. AREA
SCALE: 3/8" = 1'-0"

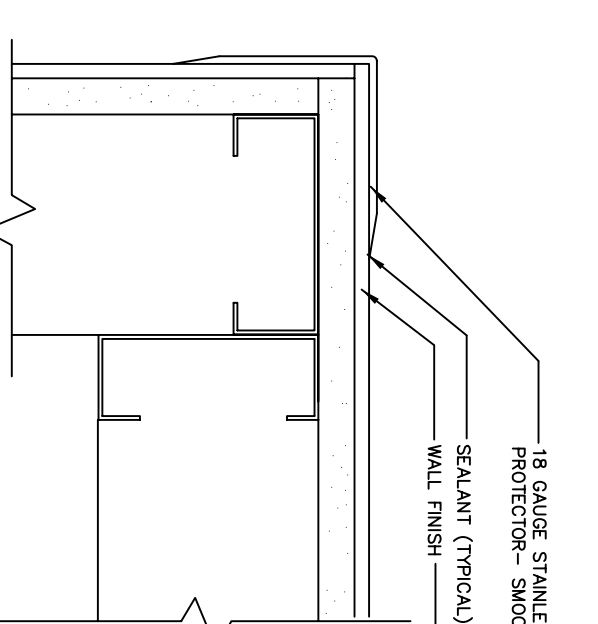

1 CORNER DETAIL
SCALE: 3" = 1'-0"

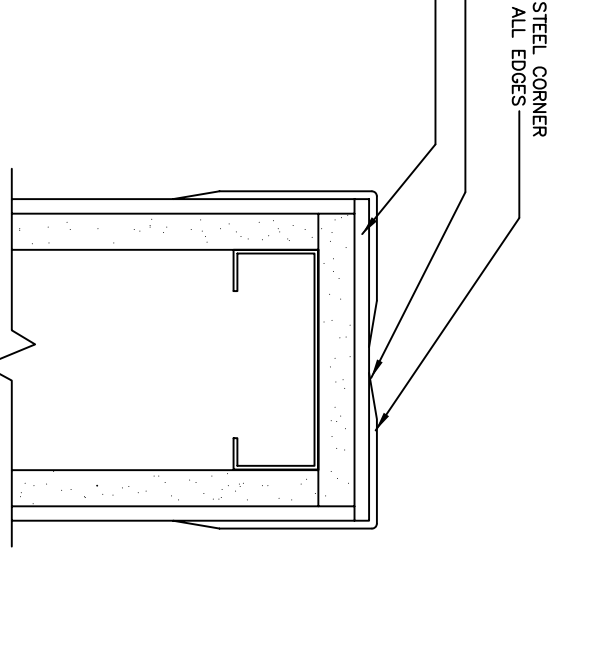

1A CORNER DETAIL
SCALE: 3" = 1'-0"

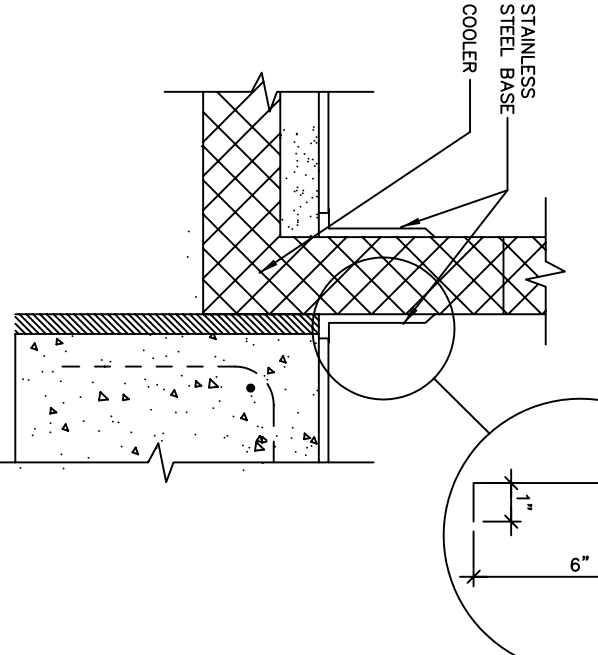

1B BASE DETAIL
SCALE: 1 1/2" = 1'-0"

REVISIONS

REV.	DESCRIPTION	DATE	BY

GRAPHIC LEGEND

- 23 DOOR REFERENCE SYMBOL.
- WINDOW REFERENCE SYMBOL.

RYAN'S FAMILY STEAK HOUSES, INC.
199 WEST STREET - CORAL GABLES, FL 33134 - (305) 991-1900

Ryan's
FAMILY STEAK HOUSE

INTERIOR ELEVATIONS
MISCELLANEOUS