

**4.6 PARKING AND PASSENGER LOADING ZONES.**

4.6.1 MINIMUM NUMBER. PARKING SPACES REQUIRED TO BE ACCESSIBLE BY 4.1 SHALL COMPLY WITH 4.6.2 THROUGH 4.6.4. PASSENGER LOADING ZONES REQUIRED TO BE ACCESSIBLE BY 4.1 SHALL COMPLY WITH 4.6.5 AND 4.6.6.

4.6.2 LOCATION. ACCESSIBLE PARKING SPACES SERVING A PARTICULAR BUILDING SHALL BE LOCATED ON THE SHORTEST ACCESSIBLE ROUTE OF TRAVEL FROM ADJACENT PARKING TO AN ACCESSIBLE ENTRANCE THAT DOES NOT SERVE A PARTICULAR BUILDING. ACCESSIBLE ROUTES OF TRAVEL TO AN ACCESSIBLE PREFERRED ENTRANCE OF PARKING, ACCESSIBLE ENTRANCES WITH ADJACENT PARKING, ACCESSIBLE PARKING SPACES SHALL BE DISPERSED AND LOCATED CLOSEST TO THE ACCESSIBLE ENTRANCES.

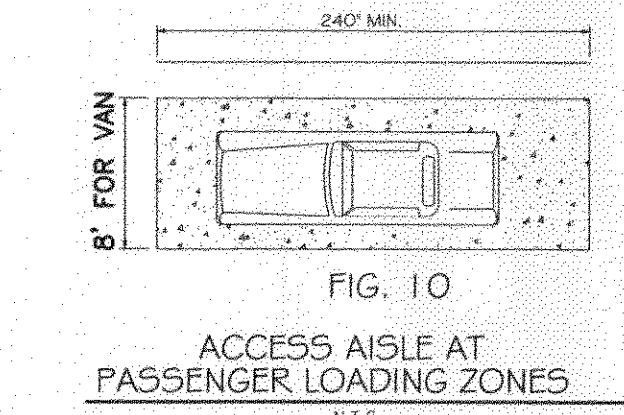

4.6.3 PARKING SPACES. PARKING SPACES FOR DISABLED PEOPLE SHALL BE AT LEAST 8' (2400mm) WIDE AND SHALL HAVE AN ADJACENT ACCESSIBLE ROUTE TO AN ADJACENT PARKING SPACE. PARKING SPACES SHALL BE PART OF AN ACCESSIBLE ROUTE TO THE BUILDING OR FACILITY ENTRANCE AND SHALL COMPLY WITH 4.6.2 THROUGH 4.6.4. PASSENGER LOADING ZONES SHALL SHARE A COMMON ACCESS AISLE. PARKED VEHICLES OVERHANGING SHALL NOT REDUCE THE CLEAR WIDTH OF AN ACCESSIBLE ROUTE. PARKING SPACES AND ACCESS AISLES SHALL BE LEVEL WITH SURFACE SLOPES NOT EXCEEDING 1:50 IN ALL DIRECTIONS.

4.6.4 SIGNAGE. ACCESSIBLE PARKING SPACES SHALL BE DESIGNATED AS RESERVED FOR THE DISABLED BY A SIGN SHOWING THE SYMBOL OF ACCESSIBILITY (SEE 4.3.0.3). SUCH SIGN SHALL NOT BE OBLSCURED BY A VEHICLE PARKED IN THE SPACE.

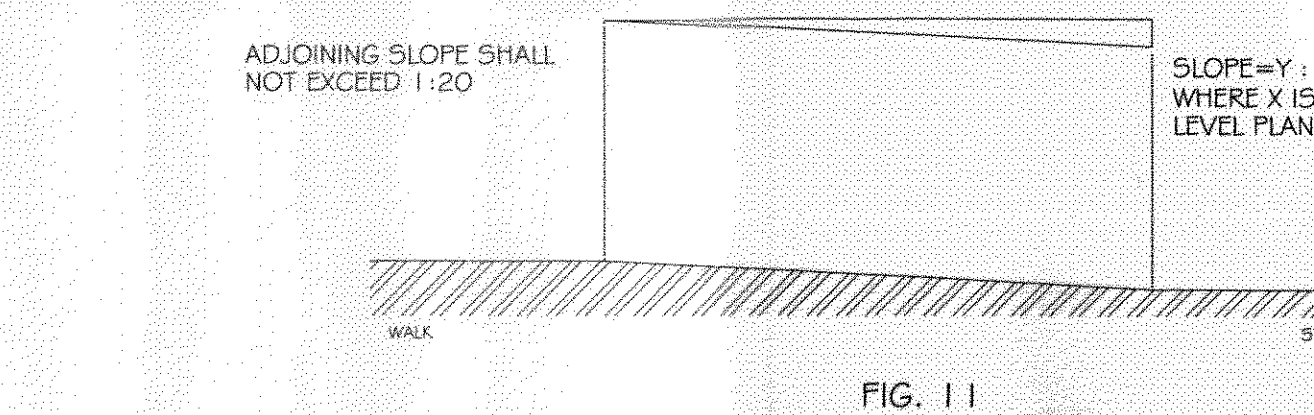
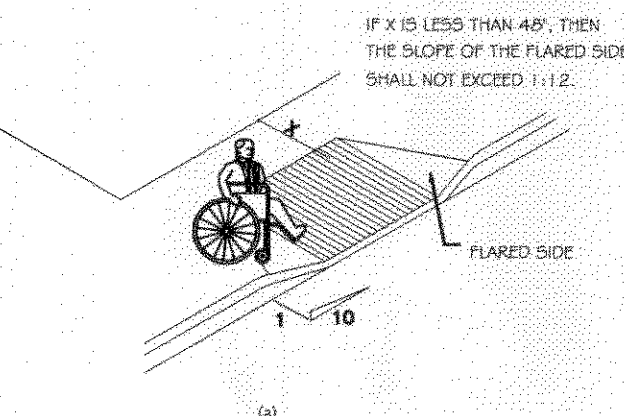

4.6.5 PASSENGER LOADING ZONES. PASSENGER LOADING ZONES SHALL PROVIDE AN ACCESS AISLE AT LEAST 6' (1829mm) WIDE AND 8' (2438mm) LONG ADJACENT AND PARALLEL TO THE VEHICLE FULL-UP SPACE (SEE FIG. 10). IF THERE ARE CURBS BETWEEN THE ACCESS AISLE AND THE VEHICLE FULL-UP SPACE, THEN A CURB RAMP COMPLYING WITH 4.7 SHALL BE PROVIDED. VEHICLE STANDING SPACES AND ACCESS AISLES SHALL BE LEVEL WITH SURFACE SLOPES NOT EXCEEDING 1:50 IN ALL DIRECTIONS.

4.6.6 VERTICAL CLEARANCE. PASSENGER LOADING ZONES SHALL PROVIDE AN ACCESS AISLE AT LEAST 6' (1829mm) WIDE AND 20' (2407mm) LONG ADJACENT AND PARALLEL TO THE VEHICLE FULL-UP SPACE (SEE FIG. 10). IF THERE ARE CURBS BETWEEN THE ACCESS AISLE AND THE VEHICLE FULL-UP SPACE, THEN A CURB RAMP COMPLYING WITH 4.7 SHALL BE PROVIDED. VEHICLE STANDING SPACES AND ACCESS AISLES SHALL BE LEVEL WITH SURFACE SLOPES NOT EXCEEDING 1:50 IN ALL DIRECTIONS.

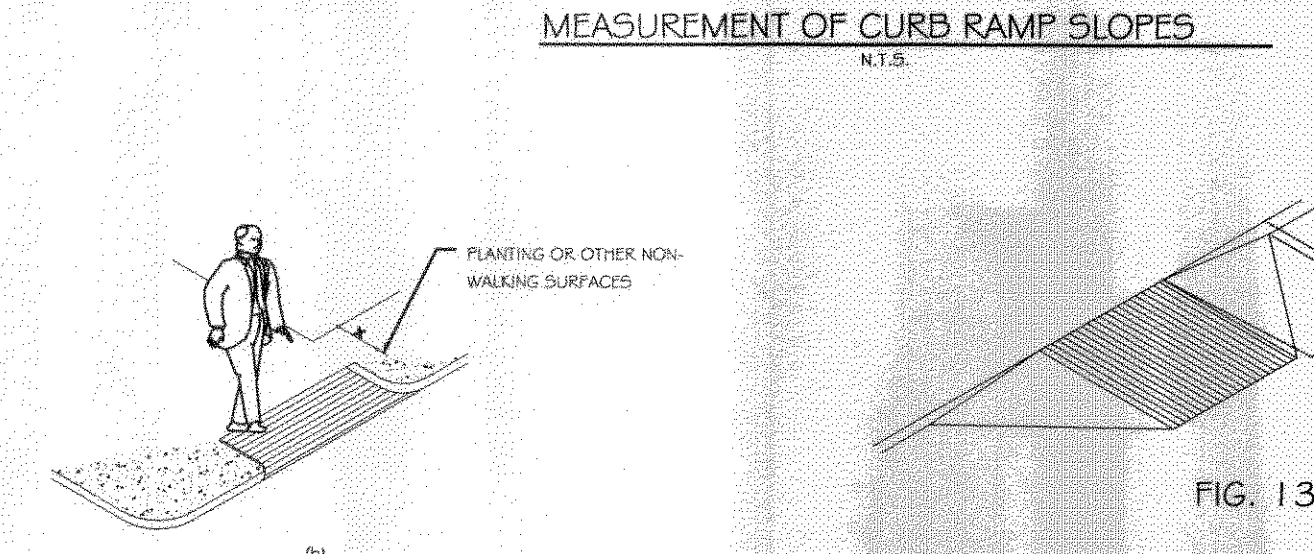

**4.7 CURB RAMPS.**

4.7.1 LOCATION. CURB RAMPS COMPLYING WITH 4.7 SHALL BE PROVIDED WHEREVER AN ACCESSIBLE ROUTE CROSSES A CURB.

4.7.2 SLOPE. SLOPES OF CURB RAMPS SHALL COMPLY WITH 4.6.2. THE SLOPE SHALL BE MEASURED AS SHOWN IN FIG. 11. TRANSITIONS FROM RAMPS TO WALKWAYS, GUTTERS, OR STREETS SHALL BE FLUSH AND FREE OF ABRUPT CHANGES. MAXIMUM SLOPES OF ADJOINING SURFACES, ROAD SURFACES IMMEDIATELY ADJACENT TO THE CURB RAMP, OR ACCESSIBLE ROUTE SHALL NOT EXCEED 1:20.

4.7.3 WIDTH. THE MINIMUM WIDTH OF A CURB RAMP SHALL BE 36", EXCLUSIVE OF FLARED SIDES.

4.7.4 SURFACE. SURFACES OF CURB RAMPS SHALL COMPLY WITH 4.5.

4.7.5 SIDES OF CURB RAMPS. IF A CURB RAMP IS LOCATED WHERE PEDESTRIANS MUST WALK, ACCESSIBLE RAMPS, OR WHERE IT IS NOT PROTECTED BY HANDRAILS OR GUARDRAILS, THEN IT SHALL HAVE FLARED SIDES. THE MINIMUM SLOPE OF THE FLARED SIDE SHALL BE 1:12. CURB RAMPS WITH RETURNED CURBS MAY BE USED WHERE PEDESTRIANS WOULD NOT NORMALLY WALK ACROSS THE RAMP (SEE FIG. 12b).

4.7.6 BUILT-UP CURB RAMPS. BUILT-UP CURB RAMPS SHALL BE LOCATED SO THAT THEY DO NOT PROJECT INTO VEHICULAR TRAFFIC LANES (SEE FIG. 13).

4.7.7 WARNING TEXTURES. (RESERVED)

4.7.8 OBSTRUCTIONS. CURB RAMPS SHALL BE LOCATED OR PROTECTED TO PREVENT THEIR OBSTRUCTION BY PARKED VEHICLES.

4.7.9 LOCATION AT MARKED CROSSINGS. CURB RAMPS AT MARKED CROSSINGS SHALL BE WHOLLY CONTAINED WITHIN THE MARKINGS, EXCLUDING ANY FLARED SIDES.

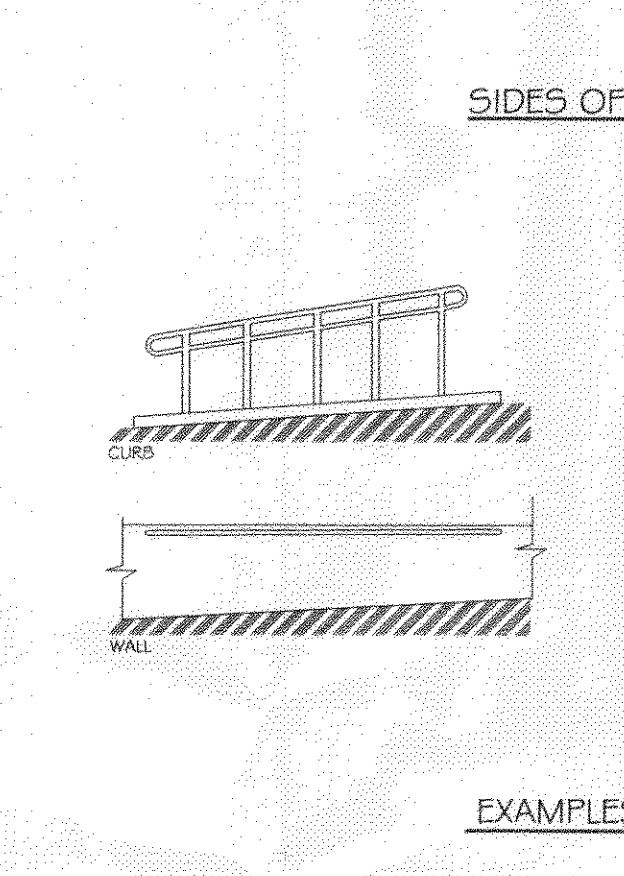

**4.8 RAMPS.**

4.8.1 GENERAL. ANY PART OF AN ACCESSIBLE ROUTE WITH A SLOPE GREATER THAN 1:20 SHALL BE CONSIDERED A RAMP AND SHALL COMPLY WITH 4.6.

4.8.2 SLOPE & RISE. THE LEAST POSSIBLE SLOPE SHALL BE USED FOR ANY RAMP. THE MAXIMUM SLOPE OF A RAMP IN NEW CONSTRUCTION SHALL BE 1:12. THE MAXIMUM RISE FOR ANY RAMP SHALL BE 6" (152mm). CURB RAMPS AND RAMPS TO BE CONSTRUCTED ON EXISTING SITES OR IN EXISTING BUILDINGS OR FACILITIES MAY HAVE SLOPES AND RISES AS SHOWN IN TABLE 2. IF SPACE LIMITATIONS PROHIBIT THE USE OF A 1:12 SLOPE OR LESS (SEE 4.1.4.6).

4.8.3 CLEAR WIDTHS. THE MINIMUM CLEAR WIDTH OF A RAMP SHALL BE 36" (915mm).

4.8.4 LANDINGS. RAMPS SHALL HAVE LEVEL LANDINGS AT THE BOTTOM AND TOP OF EACH RUN. LANDINGS SHALL HAVE THE FOLLOWING FEATURES:

- (1) THE LANDING SHALL BE AT LEAST AS WIDE AS THE RAMP RUN LEADING TO IT.
- (2) THE LANDING LENGTH SHALL BE A MINIMUM OF 60" (1525mm) CLEAR.
- (3) IF RAMPS CHANGE DIRECTION AT LANDINGS, THE MINIMUM LANDING SIZE SHALL BE 60" (1525mm) BY (1525mm).
- (4) IF A DOORWAY IS LOCATED AT A LANDING, THEN THE AREA IN FRONT OF THE DOORWAY SHALL COMPLY WITH 4.13.4.

4.8.5 HANDRAILS. IF A RAMP RUN HAS A RISE GREATER THAN 6" (152mm) OR A HORIZONTAL PROJECTION GREATER THAN 7' (2133mm), THEN IT SHALL HAVE HANDRAILS ON BOTH SIDES. HANDRAILS ARE NOT REQUIRED ON CURB RAMPS. HANDRAILS SHALL COMPLY WITH 4.8.6 AND SHALL HAVE THE FOLLOWING FEATURES:

- (1) HANDRAILS SHALL BE PROVIDED ALONG BOTH SIDES OF RAMP SEGMENTS. THE INSIDE HANDRAIL OR SWITCHBACK OR DOGGLE RAMPS SHALL ALWAYS BE CONTINUOUS.
- (2) IF HANDRAILS ARE NOT CONTINUOUS, THEY SHALL EXTEND AT LEAST 12" (305mm) BEYOND THE TOP AND BOTTOM OF THE RAMP SEGMENT AND SHALL BE PARALLEL WITH THE FLOOR OR GROUND SURFACE.
- (3) THE CLEAR SPACE BETWEEN THE HANDRAIL AND THE WALL SHALL BE 1-1/2" (38mm).
- (4) GRIPPING SURFACES SHALL BE CONTINUOUS.
- (5) TOP OF HANDRAIL GRIPPING SURFACES SHALL BE MOUNTED BETWEEN 30" & 34" (762mm & 863mm) ABOVE RAMP SURFACES.
- (6) ENDS OF HANDRAILS SHALL BE EITHER ROUNDED OR RETURNED SMOOTHLY TO FLOOR, WALL, OR POST.
- (7) HANDRAILS SHALL NOT ROTATE WITH THEIR FITTINGS.

4.8.6 CROSS SLOPE & SURFACES. THE CROSS SLOPE OF RAMP SURFACES SHALL BE NO GREATER THAN 1:50. RAMP SURFACES SHALL COMPLY WITH 4.5.

4.8.7 EDGE PROTECTION. RAMPS AND LANDINGS WITH DROP-OFFS SHALL HAVE CURBS, WALLS, RAILINGS, OR PROTECTIVE SURFACES THAT PREVENT PEOPLE FROM SLIPPING OFF THE RAMP. CURBS SHALL BE A MINIMUM OF 2" (50mm) HIGH (SEE FIG. 17).

4.8.8 OUTDOOR CONDITIONS. OUTDOOR RAMPS AND THEIR APPROACHES SHALL BE DESIGNED SO THAT WATER WILL NOT ACCUMULATE ON WALKING SURFACES.

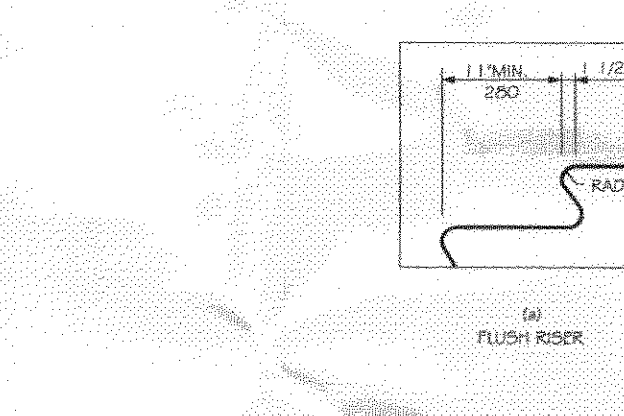

**4.9 STAIRS.**

4.9.1 MINIMUM NUMBER. STAIRS REQUIRED TO BE ACCESSIBLE BY 4.1 SHALL COMPLY WITH 4.9.

4.9.2 TREADS & RISERS. ON ANY GIVEN FLIGHT OF STAIRS, ALL STEPS SHALL HAVE UNIFORM RISER HEIGHTS AND UNIFORM TREAD WIDTHS. STAIR TREADS SHALL BE NO LESS THAN 11" (280mm) WIDE, MEASURING FROM RISER TO RISER (SEE FIG. 18a). OPEN RISERS ARE NOT PERMITTED ON ACCESSIBLE ROUTES.

4.9.3 NOSINGS. THE UNDERSIDES OF NOSINGS SHALL NOT BE ABRUPT. THE RADIUS OF CURVATURE AT THE LEADING EDGE OF THE TREAD SHALL BE NO GREATER THAN 1/2" (13mm). RISERS SHALL BE FLUSH OR THE UNDERSIDE OF THE NOSING SHALL HAVE AN ANGLE NOT LESS THAN 60 DEGREES FROM THE HORIZONTAL. NOSINGS SHALL PROJECT NO MORE THAN 1-1/8" (36mm) (SEE FIG. 18).

4.9.4 HANDRAILS. STAIRWAYS SHALL HAVE HANDRAILS AT BOTH SIDES OF ALL STAIRS. HANDRAILS SHALL COMPLY WITH 4.8.6 AND SHALL HAVE THE FOLLOWING FEATURES:

- (1) HANDRAILS SHALL BE CONTINUOUS ALONG BOTH SIDES OF STAIRS. THE INSIDE HANDRAIL OR SWITCHBACK OR DOGGLE STAIRS SHALL ALWAYS BE CONTINUOUS (SEE FIG. 19a) & (b).
- (2) IF HANDRAILS ARE NOT CONTINUOUS, THEY SHALL EXTEND AT LEAST 12" (305mm) BEYOND THE TOP AND BOTTOM OF THE STAIR SEGMENT. AT THE TOP, THE EXTENSION SHALL BE PARALLEL WITH THE FLOOR OR GROUND SURFACE. AT THE BOTTOM, THE HANDRAIL SHALL CONTINUE TO THE UNDERSIDE OF THE TREAD OF ONE TREAD FROM THE BOTTOM RISER. THE REMAINDER OF THE EXTENSION SHALL BE HORIZONTAL (SEE FIG. 19c) & (d). HANDRAIL EXTENSIONS SHALL COMPLY WITH 4.8.6.
- (3) THE CLEAR SPACE BETWEEN HANDRAILS AND WALLS SHALL BE 1-1/2" (38mm).
- (4) GRIPPING SURFACES SHALL BE UNINTERRUPTED BY NIBEL POSITS, OTHER CONSTRUCTION ELEMENTS, OR OBSTRUCTIONS.
- (5) TOP OF HANDRAIL GRIPPING SURFACE SHALL BE MOUNTED BETWEEN 30" & 34" (762mm & 863mm) ABOVE STAIR NOSINGS.
- (6) ENDS OF HANDRAILS SHALL BE EITHER ROUNDED OR RETURNED SMOOTHLY TO FLOOR, WALL, OR POST.
- (7) HANDRAILS SHALL NOT ROTATE WITH THEIR FITTINGS.

4.9.5 TACTILE WARNINGS AT STAIRS. (RESERVED)

4.9.6 OUTDOOR CONDITIONS. OUTDOOR STAIRS AND THEIR APPROACHES SHALL BE DESIGNED SO THAT WATER WILL NOT ACCUMULATE ON WALKING SURFACES.

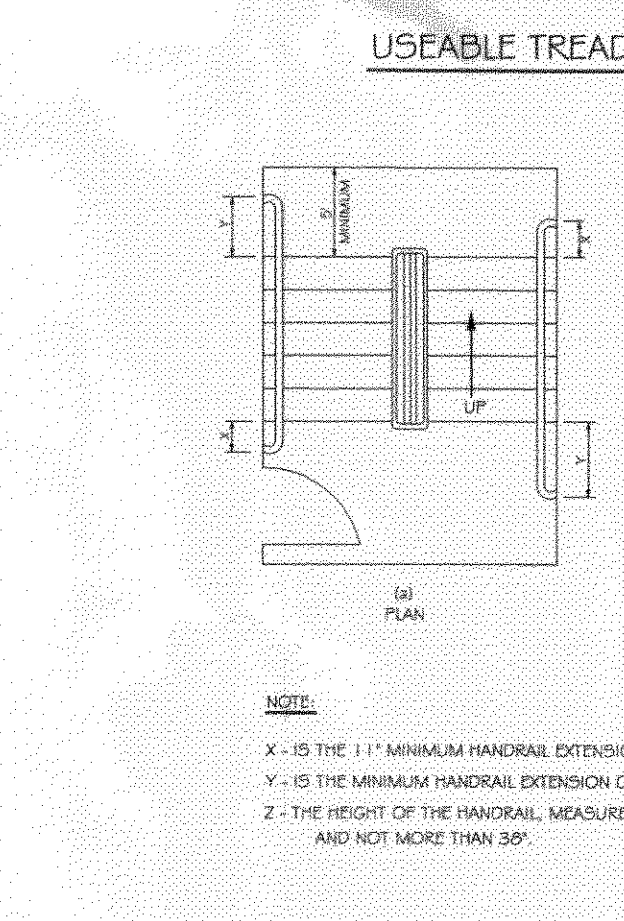

**4.10 ELEVATORS.**

4.10.1 GENERAL. ACCESSIBLE ELEVATORS SHALL BE ON AN ACCESSIBLE ROUTE AND SHALL COMPLY WITH 4.1.0 AND WITH THE ASME A17.1-1990 SAFETY CODE FOR ELEVATORS AND ESCALATORS. RESIDENT ELEVATORS SHALL NOT BE CONSIDERED AS MEETING THE REQUIREMENTS OF THIS SECTION UNLESS THE ONLY ELEVATORS PROVIDED ARE USED AS COMBINATION PASSENGER AND FREIGHT ELEVATORS FOR THE PUBLIC AND EMPLOYEES.

4.10.2 AUTOMATIC OPERATION. ELEVATOR OPERATION SHALL BE AUTOMATIC. EACH CAR SHALL BE EQUIPPED WITH A SELF-LEVING FEATURE THAT WILL AUTOMATICALLY BRING THE CAR TO FLOOR LANDINGS WITHIN A TOLERANCE OF 1/2" (13mm) UNLESS BATED LOADING 200% TO LOADING CONDITIONS. THIS SELF-LEVING FEATURE SHALL BE AUTOMATIC AND INDEPENDENT OF THE OPERATING DEVICE AND SHALL CORRECT THE OVERTRAVEL OR UNDERTRAVEL.

4.10.3 HALL CALL BUTTONS. CALL BUTTONS IN ELEVATOR LOBBIES AND HALLS SHALL BE CONTINUED AT 48" (1219mm) ABOVE THE FLOOR. SUCH CALL BUTTONS SHALL HAVE VISUAL SIGNALS TO INDICATE WHEN EACH CALL IS REGISTERED AND WHEN EACH CALL IS ANSWERED. CALL BUTTONS SHALL BE A MINIMUM OF 3 1/2" (89mm) IN THE SMALLEST DIMENSION. CALL BUTTONS SHALL BE LOCATED AT THE TOP OF THE CAR. BUTTONS SHALL BE 1 1/2" (38mm) IN DIAMETER. OBJECTS MOUNTED BENEATH HALL CALL BUTTONS SHALL NOT PROJECT INTO THE ELEVATOR LOBBY MORE THAN 4" (102mm).

4.10.4 HALL LANTERNS. A VISIBLE AND AUDIBLE SIGNAL SHALL BE PROVIDED AT EACH HOISTWAY ENTRANCE TO NOTIFY WHICH CAR IS RESPONDING A CALL. ALTERNATE SIGNALS SHALL SOUND ONCE FOR THE UP DIRECTION AND TWICE FOR THE DOWN DIRECTION OR SHALL HAVE VERBAL ANNOUNCEMENTS THAT SAY "UP" OR "DOWN". VISIBLE SIGNALS SHALL HAVE THE FOLLOWING FEATURES:

- (1) HALL LANTERN FIXTURES SHALL BE MOUNTED SO THAT THEIR CENTERLINE IS AT LEAST 2' (1829mm) IN THE SMALLEST DIMENSION.
- (2) VISIBLE ELEMENTS SHALL BE AT LEAST 2-1/2" (64mm) IN THE SMALLEST DIMENSION.
- (3) SIGNALS SHALL BE VISIBLE FROM THE VICINITY OF THE HALL CALL BUTTON, IN CAR LANTERNS LOCATED IN CARS, VISIBLE FROM THE VICINITY OF HALL CALL BUTTONS, AND CONFORMING TO THE ABOVE REQUIREMENTS, SHALL BE ACCEPTABLE.

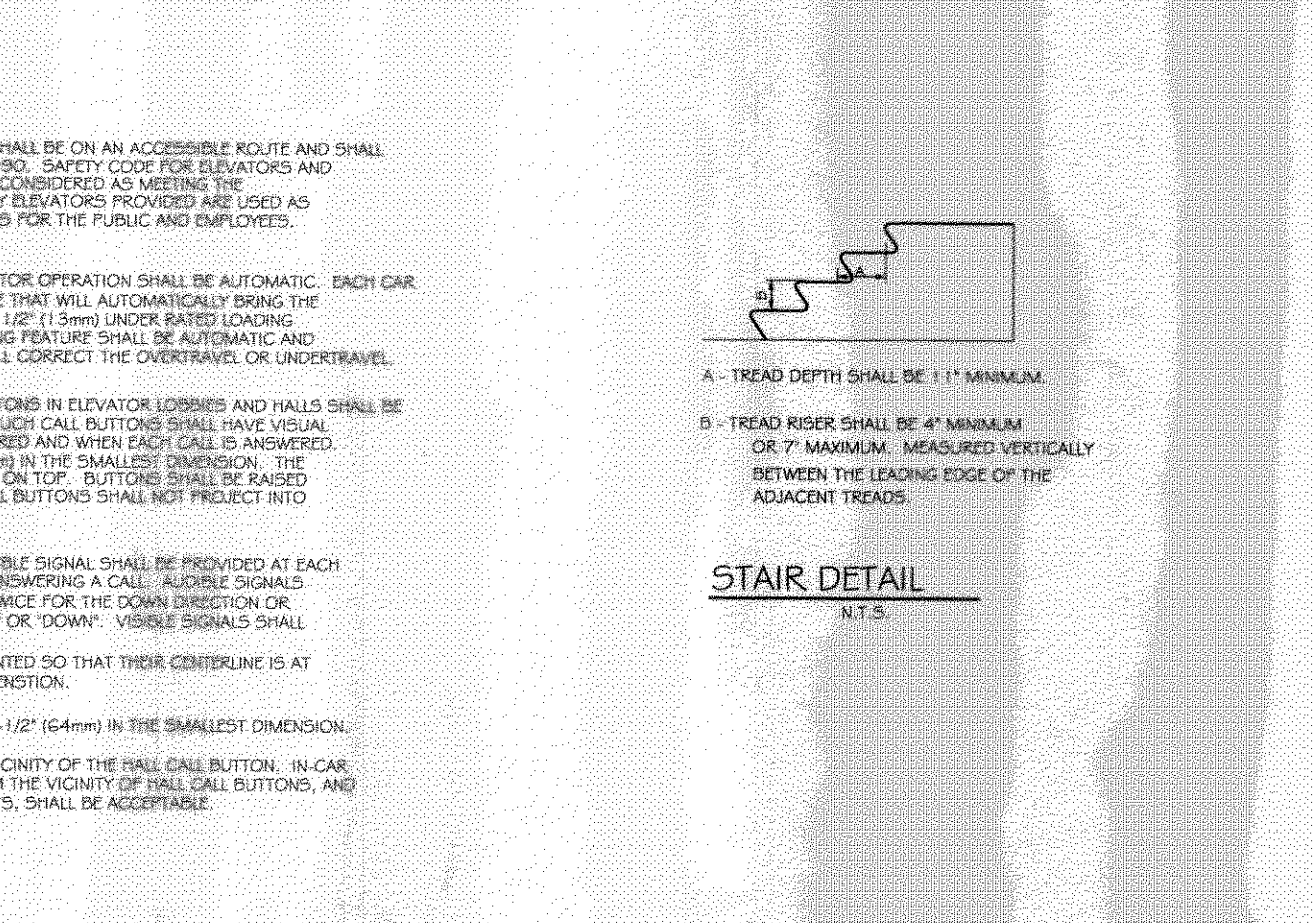

**4.10.5 RAISED & BRILLE CHARACTERS ON HOISTWAY ENTRANCES.**

ALL ELEVATOR HOISTWAY ENTRANCES SHALL HAVE RAISED AND BRILLE FLOOR DESIGNATIONS PROVIDED ON BOTH JAMBS. THE CENTERLINE OF THE CHARACTERS SHALL BE 42" (1067mm) ABOVE FINISH FLOOR. SUCH CHARACTERS SHALL BE 2" (50mm) HIGH AND SHALL COMPLY WITH 4.2.4. PERMANENTLY APPLIED FLOORS ARE ACCEPTABLE IF THEY ARE PERMANENTLY FIXED TO THE JAMBS.

4.10.6 DOOR PROTECTIVE DEVICES. ELEVATOR DOORS SHALL OPEN AND CLOSE AUTOMATICALLY. THEY SHALL BE PROVIDED WITH A REOPENING DEVICE THAT WILL STOP AND REOPEN A CAR OR HOISTWAY DOOR AUTOMATICALLY IF THE DOOR BECOMES OBSTRUCTED BY AN OBJECT OR PERSON. THE DEVICE SHALL BE CAPABLE OF COMPLETING THESE OPERATIONS WITHOUT REQUIRING CONTACT FOR AN OBSTRUCTION PASSING THROUGH THE OPENING AT HEIGHTS OF 5" & 29" (127mm & 738mm) ABOVE FINISH FLOOR. DOOR REOPENING DEVICES SHALL REMAIN EFFECTIVE FOR AT LEAST 20 SECONDS. AFTER SUCH AN INTERVAL, DOORS MAY CLOSE IN ACCORDANCE WITH THE REQUIREMENTS OF ASME A17.1-1990.

4.10.7 DOOR SIGNAL TIMING FOR HALL CALLS. THE MINIMUM ACCEPTABLE TIME FROM NOTIFICATION THAT A CAR IS RESPONDING UNTIL THE DOORS OF THAT CAR START TO CLOSE SHALL BE CALCULATED FROM THE FOLLOWING EQUATION:

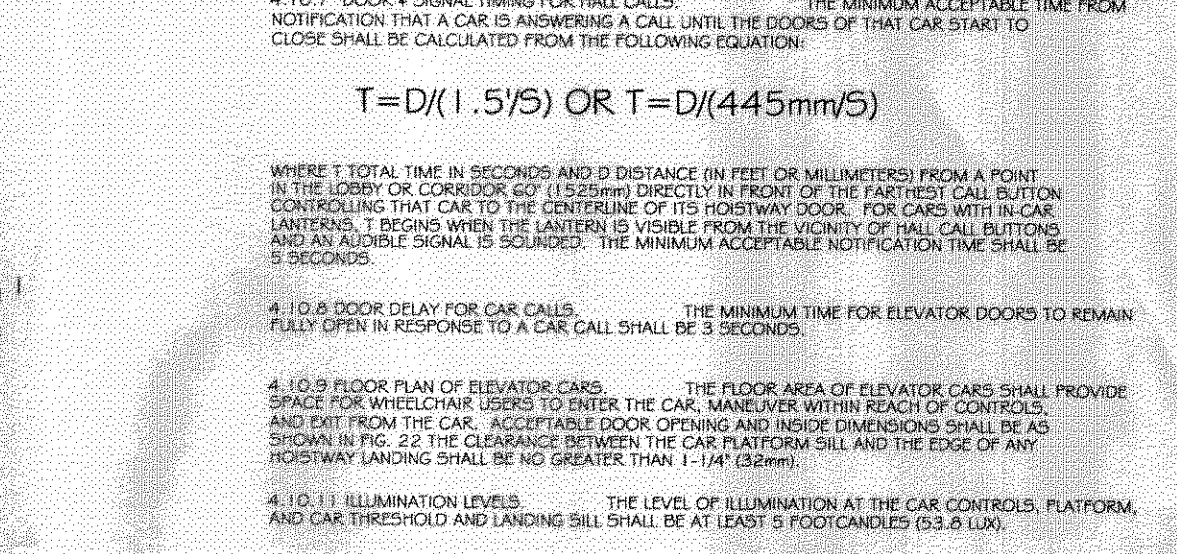
$$T = D / (1.5/5) \text{ OR } T = D / (445 \text{ mm/5})$$

**4.10.8 DOOR DELAY FOR CAR CALLS.**

THE MINIMUM TIME FOR ELEVATOR DOORS TO REMAIN FULLY OPEN IN RESPONSE TO A CAR CALL SHALL BE 3 SECONDS.

4.10.9 FLOOR PLAN OF ELEVATOR CARS. THE FLOOR AREA OF ELEVATOR CARS SHALL PROVIDE SPACE FOR WHEELCHAIR USERS TO ENTER THE CAR, MANEUVER WITHIN REACH OF CONTROL, AND EXIT FROM THE CAR. ACCESSIBLE DOOR OPENING AND INSIDE DIMENSIONS SHALL BE AS SHOWN IN FIG. 22. THE CLEARANCE BETWEEN THE CAR PLATFORM SILL AND THE EDGE OF ANY HOISTWAY LANDING SHALL BE NO GREATER THAN 1/4" (6.35mm).

4.10.10 ILLUMINATION AND LANDING. THE LEVEL OF ILLUMINATION AT THE CAR CONTROLS, PLATFORM, AND CAR THRESHOLD AND LEVELS SHALL BE AT LEAST 5 FOOT-CANDELES (53.5 LUX).

4.10.11 CAR CONTROLS. ELEVATOR CONTROL PANELS SHALL HAVE THE FOLLOWING FEATURES:

- (1) BUTTONS. ALL CONTROL BUTTONS SHALL BE AT LEAST 3/4" (19mm) IN THEIR SMALLEST DIMENSION. THEY SHALL BE RAISED OR FLUSH.
- (2) TACTILE, BRILLE, AND VISUAL CONTROL INDICATORS. ALL CONTROL BUTTONS SHALL BE DESIGNATED BY BRILLE AND RAISED STANDING ALPHABET CHARACTERS FOR LETTERS, DIGITS, AND SYMBOLS. RAISED STANDING ALPHABET CHARACTERS FOR LETTERS, DIGITS, AND SYMBOLS SHALL BE 1/8" (3.18mm) HIGH. STANDARD BRILLE SHALL BE AS SHOWN IN FIG. 23a. CALL BUTTONS FOR THE MAIN ENTRY FLOOR SHALL BE DESIGNATED BY A RAISED BRILLE CHARACTER. ALL RAISED DESIGNATIONS FOR CONTROL BUTTONS SHALL BE PLACED IMMEDIATELY TO THE LEFT OF THE BUTTON TO WHICH THEY APPLY. APPLIED PLATES, PERMANENTLY ATTACHED, ARE AN ACCEPTABLE MEANS TO PROVIDE BRILLE CONTROL DESIGNATIONS. FLOOR BUTTONS SHALL BE PROVIDED WITH VISUAL INDICATORS TO SHOW WHICH CALL IS REGISTERED. THE VISUAL INDICATORS SHALL BE EXTINGUISHED WHEN EACH CALL IS ANSWERED.
- (3) HEIGHT. ALL FLOOR BUTTONS SHALL BE NO HIGHER THAN 54" (1370mm) ABOVE THE FINISH FLOOR FOR SIDE APPROACH AND 48" (1220mm) FOR FRONT APPROACH. EMERGENCY CONTROL PANELS, INCLUDING THE EMERGENCY ALARM, SHALL BE MOUNTED AT THE BOTTOM OF THE PANEL AND SHALL HAVE THEIR CENTERLINE NO LESS THAN 30" (762mm) ABOVE THE FINISH FLOOR (SEE FIG. 23b) & (c).
- (4) LOCATION. CONTROLS SHALL BE LOCATED ON A FRONT WALL OF CARS HAVE CENTER OPENING DOORS, AND AT THE SIDE WALL OF CARS THAT WILL NOT TO THE DOOR IF CARS HAVE SIDE OPENING DOORS (SEE FIG. 23d) & (e).

4.10.12 CAR POSITION INDICATORS. IN ELEVATOR CARS, A VISUAL CAR POSITION INDICATOR SHALL BE PROVIDED ABOVE THE CAR CONTROL PANEL OR OVER THE DOOR TO SHOW THE POSITION OF THE ELEVATOR IN THE HOISTWAY. AS THE CAR PASSES OR STOPS AT A FLOOR SERVED BY THE ELEVATOR, THE CORRESPONDING NUMERALS SHALL ILLUMINATE, AND AN AUDIBLE SIGNAL SHALL SOUND. NUMERALS SHALL BE A MINIMUM OF 1/2" (13mm) HIGH. THE AUDIBLE SIGNAL SHALL BE NO LESS THAN 60 DECBELS WITH A FREQUENCY NO HIGHER THAN 1100 HZ. THE FLOOR NUMBER AT WHICH A CAR STOPS OR WHICH A CAR STOPS MAY BE SUBSTITUTED FOR AN AUTOMATIC VISUAL ANNOUNCEMENT THE AUDIBLE SIGNAL.

4.10.13 EMERGENCY COMMUNICATIONS. IF PROVIDED, EMERGENCY TWO-WAY COMMUNICATION SYSTEMS BETWEEN THE ELEVATOR AND A POINT OUTSIDE THE HOISTWAY SHALL COMPLY WITH ASME A17.1-1990. THE HIGHEST OPERABLE RATE OF A TWO-WAY COMMUNICATION SYSTEM SHALL BE A MINIMUM OF 48" (1219mm) FROM THE FLOOR OF THE CAR. IT SHALL BE IDENTIFIED BY A RAISED SYMBOL AND LETTERING COMPLETED BY THE CAR. IT SHALL BE LOCATED TO THE LEFT OF THE CAR CONTROL PANEL. THE LENGTH OF THE CORD FROM THE PANEL TO THE HANGING SHALL BE AT LEAST 29" (738mm). IF THE SYSTEM IS LOCATED IN A CLOSED COMPARTMENT, THE COMPARTMENT DOOR HARDWARE SHALL CONFORM TO 4.2.7. CONTROLS AND OPERATING MECHANISMS. THE EMERGENCY INTERCOMMUNICATION SYSTEM SHALL NOT REQUIRE VOICE COMMUNICATION.

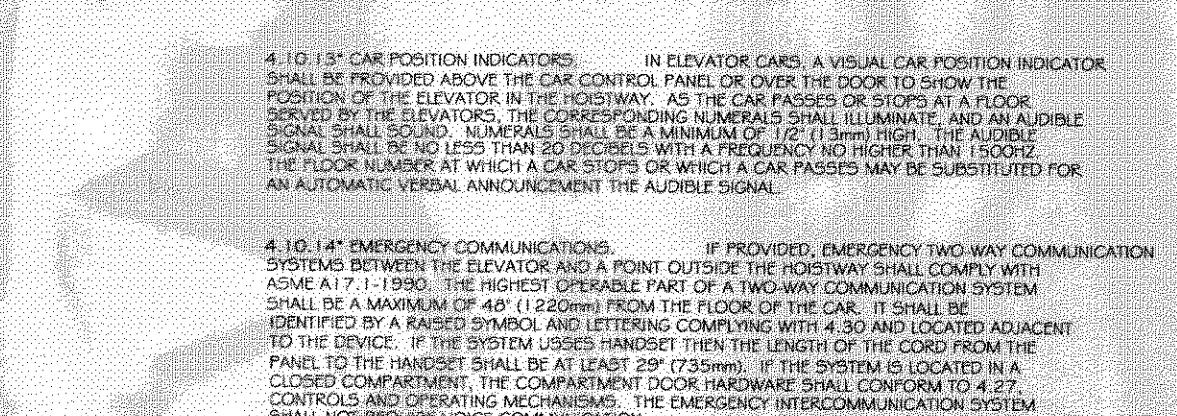

**4.10.14 EMERGENCY COMMUNICATIONS.**

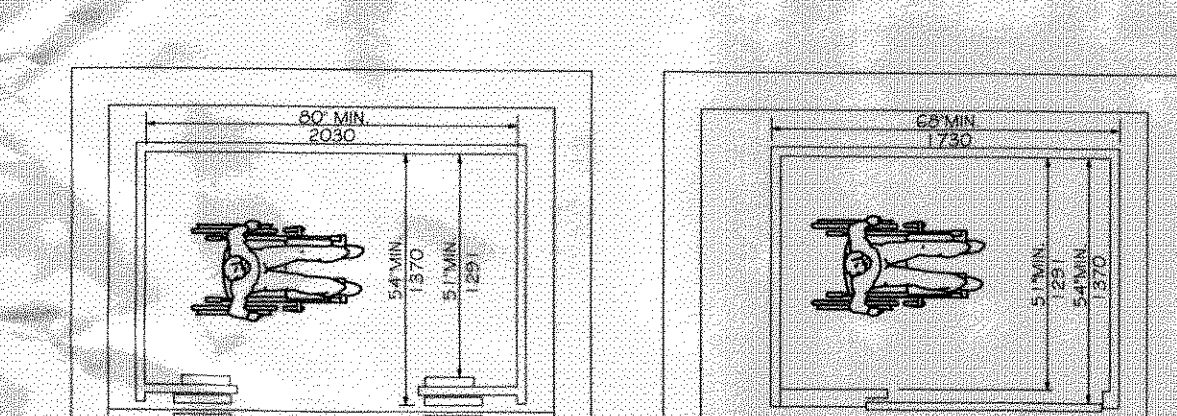

**4.10.15 CAR CONTROLS.**

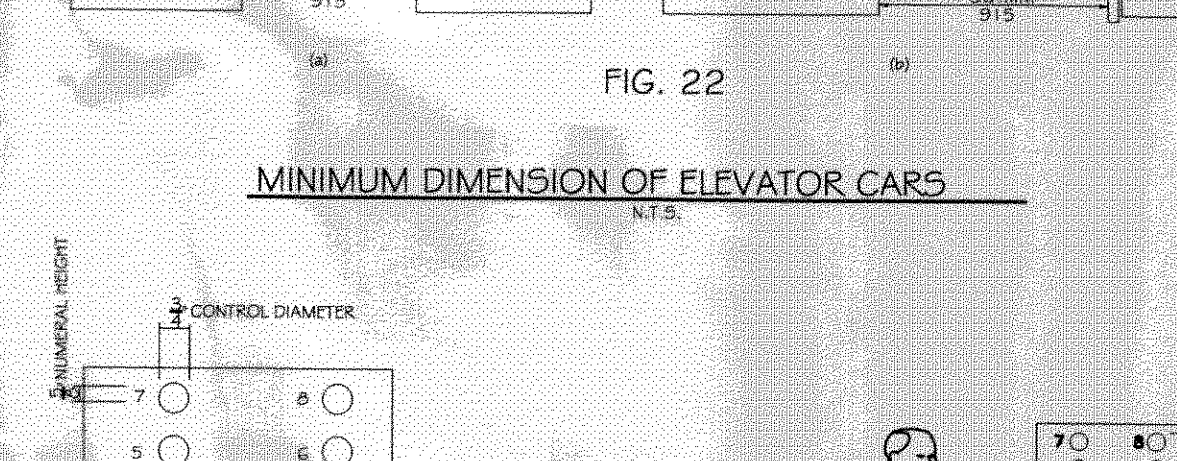

**4.10.16 EMERGENCY COMMUNICATIONS.**

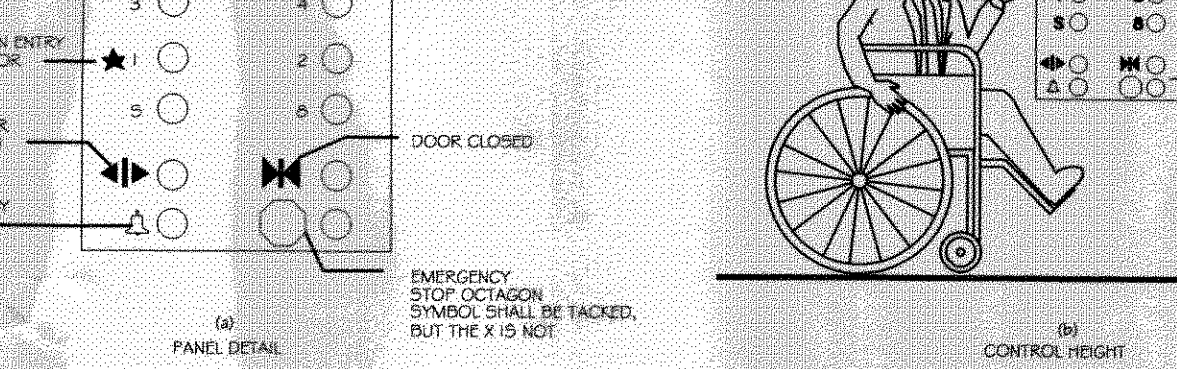

**4.10.17 CAR CONTROLS.**

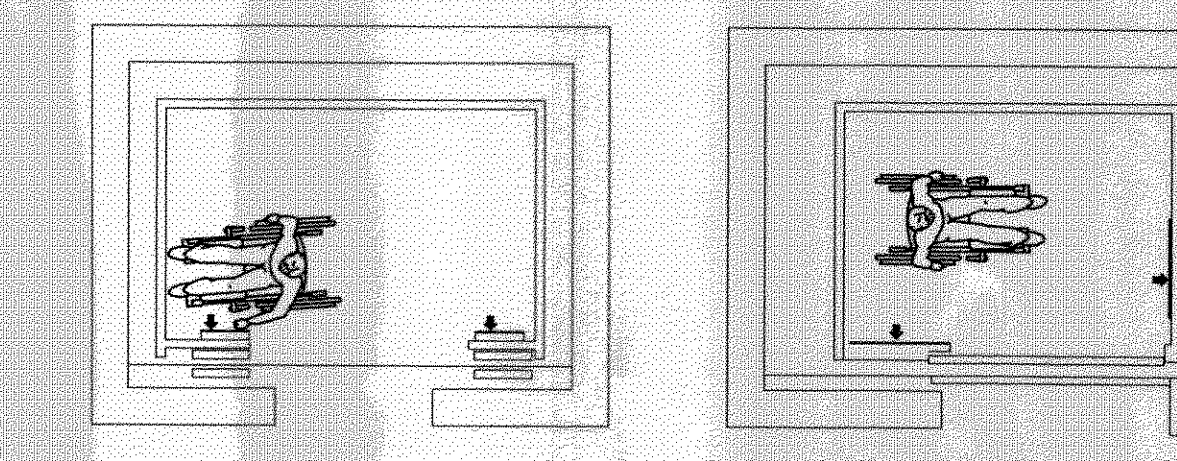

**4.10.18 EMERGENCY COMMUNICATIONS.**

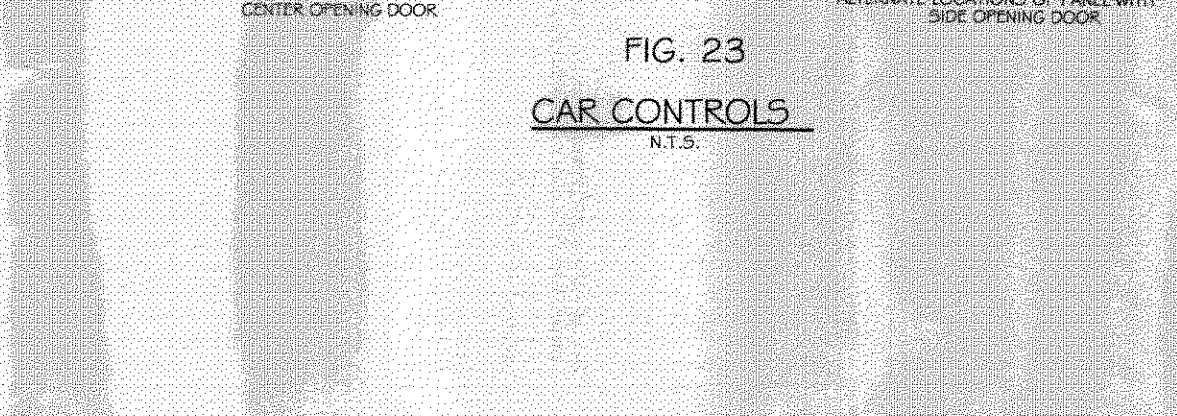

**4.11 PLATFORM LIFTS (WHEELCHAIR LIFTS).**

4.11.1 LOCATION. PLATFORM LIFTS (WHEELCHAIR LIFTS) PERMITTED BY 4.1 SHALL COMPLY WITH THE REQUIREMENTS OF 4.1.1.

4.11.2 OTHER REQUIREMENTS. IF PLATFORM LIFTS (WHEELCHAIR LIFTS) ARE USED, THEY SHALL COMPLY WITH 4.2.4, 4.5, 4.2.7, ASME A17.1 SAFETY CODE FOR ELEVATORS AND ESCALATORS, SECTION XI, 1990.

4.11.3 ENTRANCE. IF PLATFORM LIFTS ARE USED THEN THEY SHALL FACILITATE UNASSISTED ENTRY, OPERATION, AND EXIT FROM THE LIFT IN COMPLIANCE WITH 4.1.1.2.

**4.12 WINDOWS.**

4.12.1 GENERAL. (RESERVED)

4.12.2 WINDOW HARDWARE. (RESERVED)

**4.13 DOORS.**

4.13.1 GENERAL. DOORS REQUIRED TO BE ACCESSIBLE BY 4.1 SHALL COMPLY WITH THE REQUIREMENTS OF 4.1.3.

4.13.2 REVOLVING DOORS & TURNSTILES. REVOLVING DOORS OR TURNSTILES SHALL NOT BE THE ONLY MEANS OF PASSAGE AT AN ACCESSIBLE ENTRANCE OR ALONG AN ACCESSIBLE ROUTE. AN ACCESSIBLE GATE OR DOOR SHALL BE PROVIDED ADJACENT TO THE TURNSTILE OR REVOLVING DOOR AND SHALL BE SO DESIGNED AS TO FACILITATE THE SAME USE PATTERN.

4.13.3 GATES. GATES, INCLUDING TICKET GATES, SHALL MEET ALL APPLICABLE SPECIFICATIONS OF 4.1.3.

4.13.4 DOUBLE LEAF DOORWAYS. IF DOORWAYS HAVE TWO INDEPENDENTLY OPERATED DOOR LEAVES, THEN AT LEAST ONE LEAF SHALL MEET THE SPECIFICATIONS IN 4.1.3.3.4.1.3.6. THAT LEAF SHALL BE AN ACTIVE LEAF.

4.13.5 CLEAR WIDTH. DOORWAYS SHALL HAVE A MINIMUM CLEAR OPENING OF 30" (762mm) WITH THE DOOR OPEN 90 DEGREES, MEASURED BETWEEN THE FACE OF THE DOOR AND THE OPPOSITE STOP. OPENINGS MORE THAN 48" (1219mm) IN WIDTH SHALL COMPLY WITH 4.1.3.5.3. EXCEPTION: DOORS NOT REQUIRING FULL USER PASSAGE, SUCH AS SHALLOW CLOSERS, MAY HAVE THE CLEAR OPENING REDUCED TO 20" (508mm) MINIMUM.

4.13.6 MANEUVERING CLEARANCES AT DOORS. THE FLOOR OR GROUND AREA WITHIN THE REQUIRED CLEARANCES SHALL BE LEVEL AND CLEAR.

EXCEPTION: ENTRY DOORS TO ACUTE CARE HOSPITAL BEDROOMS FOR IN-PATIENTS SHALL BE DESIGNED FROM THE OPERATING ROOM SPACE AT THE LATCH SIDE OF THE DOOR IF THE DOOR IS AT LEAST 44" (1118mm) WIDE.

4.13.7 TWO DOORS IN SERIES. THE MINIMUM SPACE BETWEEN TWO HINGED OR PIVOTED DOORS IN SERIES SHALL BE 48" (1219mm) PLUS THE WIDTH OF ANY DOOR SWINGING INTO THE SPACE. SWINGING DOORS SHALL BE OPENED IN THE SAME DIRECTION OR AWAY FROM THE SPACE BETWEEN THE DOORS.

4.13.8 THRESHOLDS AT DOORWAYS. THRESHOLDS AT DOORWAYS SHALL NOT EXCEED 3/4" (19mm) IN HEIGHT FOR EXTERIOR SLIDING DOORS OR 1/2" (13mm) FOR OTHER TYPES OF DOORS. RAISED THRESHOLDS AND FLOOR LEVEL CHANGES AT ACCESSIBLE DOORWAYS SHALL BE DEVELOPED WITH A SLOPE NO GREATER THAN 1:2 (SEE 4.5.3).

4.13.9 DOOR HARDWARE. HANDLES, PULLS, LATCHES, LOCKS, AND OTHER OPERATING DEVICES ON ACCESSIBLE DOORS SHALL HAVE A SHAPE THAT IS EASY TO GRASP WITH ONE HAND AND DOES NOT REQUIRE TIGHT GRASPING, TIGHT FINGERING, OR TWISTING OF THE WRIST TO OPERATE. LEVER-OPERATED MECHANISMS, PUSH-TYPE MECHANISMS, AND LIGHTED HANDLES ARE ACCEPTABLE DESIGNS. WHEN SLIDING DOORS ARE FULLY OPEN, OPERATING HARDWARE SHALL BE EXPOSED AND LEADERS FROM BOTH SIDES. HARDWARE REQUIRED FOR ACCESSIBLE DOOR PASSAGE SHALL BE MOUNTED NO HIGHER THAN 48" (1219mm) ABOVE FINISHED FLOOR.

4.13.10 DOOR CLOSERS. IF A DOOR HAS A CLOSER, THEN THE SWEEP PERIODIC OF THE CLOSER SHALL BE ADJUSTED SO THAT FROM AN OPEN POSITION OF 70 DEGREES, THE DOOR WILL TAKE AT LEAST 3 SECONDS TO MOVE TO A POINT 3" (76mm) FROM THE LATCH, MEASURED TO THE LEADING EDGE OF THE DOOR.

4.13.11 DOOR OPENING FORCE. THE MAXIMUM FORCE FOR PUSHING OR PULLING OPEN A DOOR SHALL BE AS FOLLOWS:

- (1) FIRE DOORS SHALL HAVE THE MINIMUM OPENING FORCE ALLOWABLE BY THE APPROPRIATE ADMINISTRATIVE AUTHORITY.
- (2) OTHER DOORS:
  - (a) EXTERIOR HINGED DOORS. (RESERVED)
  - (b) EXTERIOR HINGED DOORS: 5 LBF (22.2 N)
  - (c) SLIDING OR FOLDING DOORS: 5 LBF (22.2 N)

THESE FORCES DO NOT APPLY TO THE FORCE REQUIRED TO RETRACT LATCH BOLTS OR DISengage OTHER DEVICES THAT MAY HOLD THE DOOR IN A CLOSED POSITION.

**4.13.12 AUTOMATIC DOORS AND POWER ASSISTED DOORS.**

IF AN AUTOMATIC DOOR IS USED, THEN IT SHALL COMPLY WITH AMERICAN STANDARD A118-1-1993. SUCH DOORS SHALL NOT OPEN TO BACK CHECK FACTORS ON OR BEYOND THE DOOR. SUCH DOORS SHALL REQUIRE NO MORE THAN 5 LBF (22.2 N) MOVEMENT. IF A POWER-ASSISTED DOOR IS USED, ITS DOOR-OPENING FORCE SHALL COMPLY WITH 4.1.3.1.1 AND TO COMPLY WITH THE REQUIREMENTS IN ANSI A118.19-1994.

**4.14 ENTRANCES.**

4.14.1 MINIMUM NUMBER. ENTRANCES REQUIRED TO BE ACCESSIBLE BY 4.1 SHALL BE PART OF AN ACCESSIBLE ROUTE COMPLYING WITH 4.3. SUCH ENTRANCES SHALL BE PROVIDED BY AN ACCESSIBLE AND TO PUBLIC TRANSPORTATION STOPS, TO ACCESSIBLE PARKING AND PASSENGER LOADING ZONES CONNECTED BY AN ACCESSIBLE ROUTE TO ACCESSIBLE SPACES OR ELEMENTS WITHIN THE BUILDING OR FACILITY.

4.14.2 SERVICE ENTRANCES. A SERVICE ENTRANCE SHALL NOT BE THE SOLE ACCESSIBLE ENTRANCE UNLESS IT IS THE ONLY ENTRANCE TO A BUILDING OR FACILITY (FOR EXAMPLE, IN A FACTORY OR GARAGE).

4.15 DRINKING FOUNTAINS AND WATER COOLERS.

4.15.1 MINIMUM NUMBER. DRINKING FOUNTAINS OR WATER COOLERS REQUIRED TO BE ACCESSIBLE BY 4.1 SHALL COMPLY WITH 4.1.3.

4.15.2 SPOUT HEIGHT. SPOUTS SHALL BE NO HIGHER THAN 36" (915mm), MEASURED FROM THE FLOOR OR GROUND SURFACES TO THE SPOUT OUTLET.

4.15.3 SPOUT LOCATION. THE SPOUTS OF DRINKING FOUNTAINS AND WATER COOLERS SHALL BE AT THE FRONT OF THE UNIT AND SHALL PROVIDE THE WATER FLOW IN A TRAJECTORY THAT IS PARALLEL OR NEARLY PARALLEL TO THE FRONT OF THE UNIT. THE SPOUT SHALL PROVIDE A FLOW OF WATER AT LEAST 4" (102mm) HIGH AND 17" (430mm) TO 18" (457mm) DEEP. SUCH UNITS SHALL ALSO HAVE A MINIMUM CLEAR FLOOR SPACE 30" BY 48" (762mm BY 1219mm) TO ALLOW A PERSON IN A WHEELCHAIR TO APPROACH THE UNIT FACING FORWARD.

4.15.4 CONTROLS. CONTROLS SHALL COMPLY WITH 4.27.4. UNIT CONTROLS SHALL BE FRONT MOUNTED ON SIDE MOUNTED NEAR THE FRONT EDGE.

4.15.5 CLEARANCES.

- (1) WALL- AND POST-MOUNTED COUNTERTOP UNITS SHALL HAVE A CLEAR FREE SPACE BETWEEN THE BOTTOM OF THE APRON AND THE FLOOR OR GROUND AT LEAST 27" (686mm) HIGH, 30" (762mm) WIDE, AND 17" (430mm) TO 18" (457mm) DEEP. SUCH UNITS SHALL ALSO HAVE A MINIMUM CLEAR FLOOR SPACE 30" BY 48" (762mm BY 1219mm) TO ALLOW A PERSON IN A WHEELCHAIR TO APPROACH THE UNIT FACING FORWARD.
- (2) FREE-STANDING OR BUILT-IN UNITS NOT HAVING A CLEAR SPACE UNDER THEM SHALL HAVE A CLEAR FLOOR SPACE AT LEAST 30" BY 48" (762mm BY 1219mm) THAT ALLOWS A PERSON IN A WHEELCHAIR TO MAKE A PARALLEL APPROACH TO THE UNIT. THIS CLEAR FLOOR SPACE SHALL ALSO HAVE A MINIMUM CLEAR FLOOR SPACE 30" BY 48" (762mm BY 1219mm) TO ALLOW A FLOOR THAT SHALL COMPLY WITH 4.2.4.

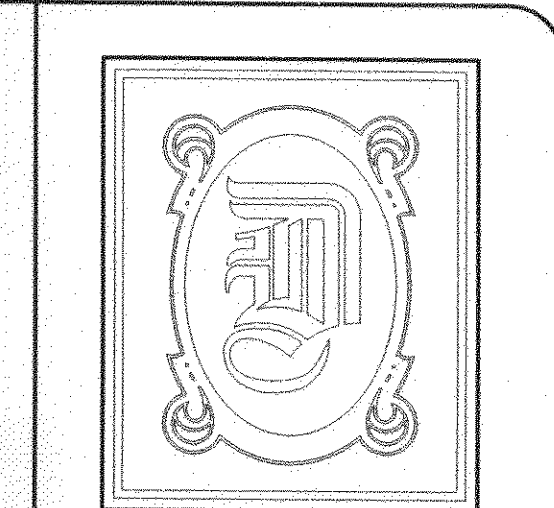

**DAMMON ENGINEERING, INC.**

CHIEF ENGINEER  
EMMETT DAMMON, P.E.

CHIEF ARCHITECT  
ROBERT WILTSE

1095 FLORIDA AVENUE  
SLIDELL, LA. 70458  
OFFICE: 985-649-5832  
FAX: 985-641-5950

WEBSITE:  
WWW.DAMMONENGINEERING.COM

EMAIL:  
DAMMONENG@BELLSOUTH.NET

ARCHITECTURE  
ENGINEERING  
STUDIES  
PLANNING  
INVESTIGATION  
EXPERT WITNESS

**NEW CREMATION AND EMBALMING FACILITY**

HONAKER FUNERAL HOME  
TERRY TRANCHINA  
751 W. GAUSE BLVD  
SLIDELL, LA

**HANDICAP DETAILS**

REV: SCALE: AS NOTED  
JOB#: 1999  
DATE: 6-9-09  
SHEET 14

371441  
REVIEWED FOR  
STATE FIRE MARSHAL  
AS PER REVIEW LETTER  
BY: WILLIAM D. JONES, ARCHITECT, CBO  
William D. Jones  
H-1  
OF 19