

15 GYPSUM BOARD BULKHEAD

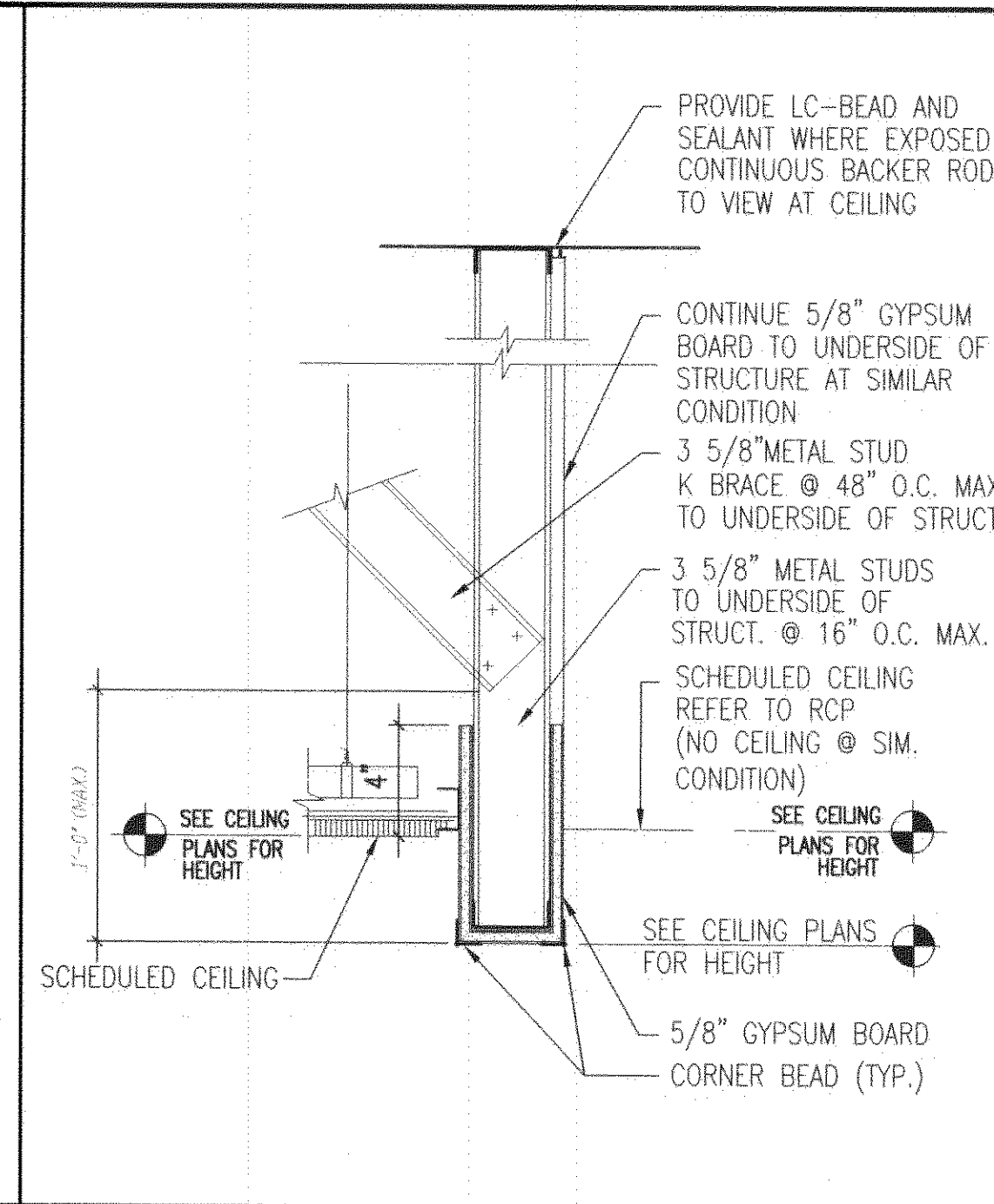

12 GYPSUM BOARD BULKHEAD

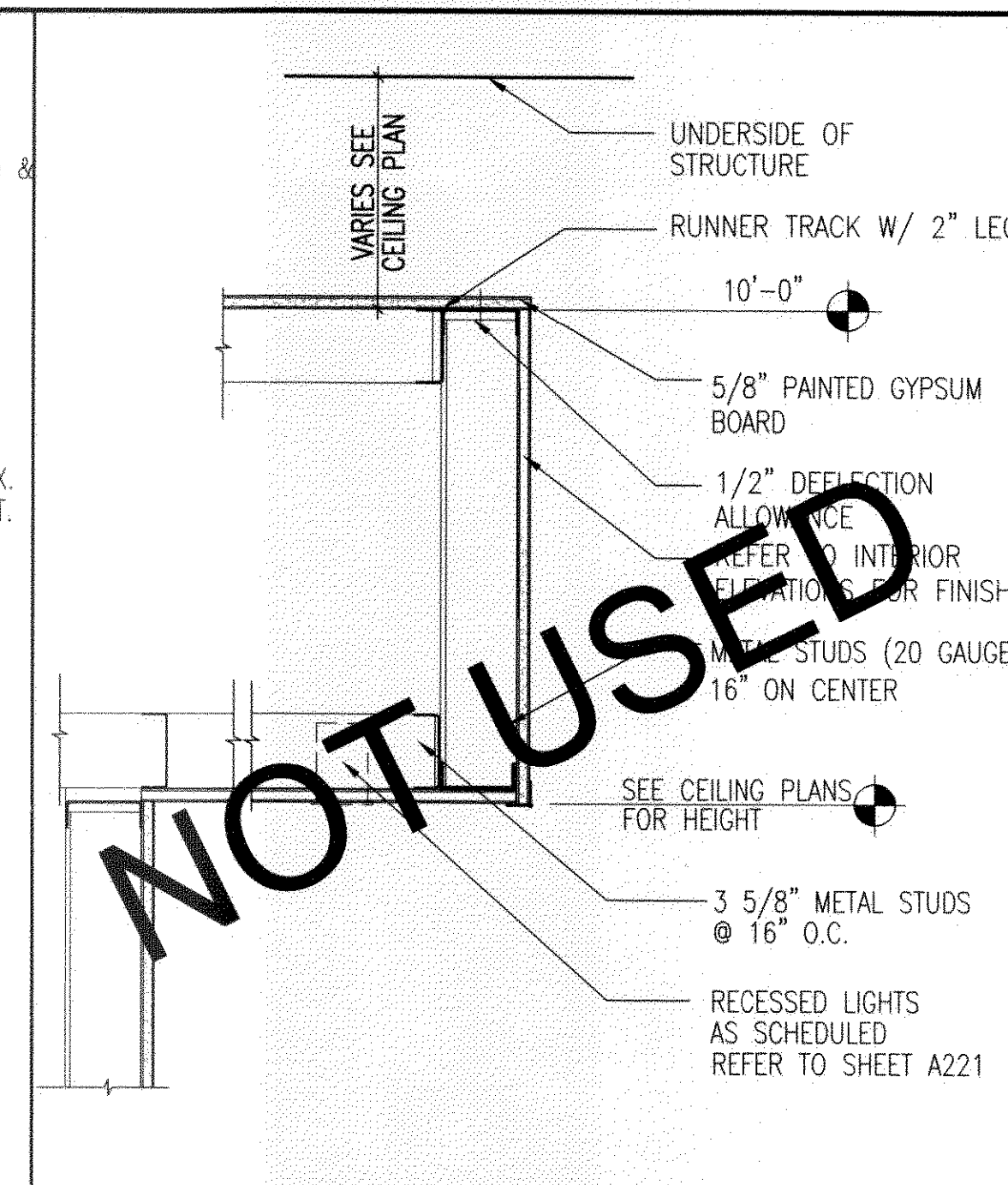

9 GYPSUM BOARD BULKHEAD

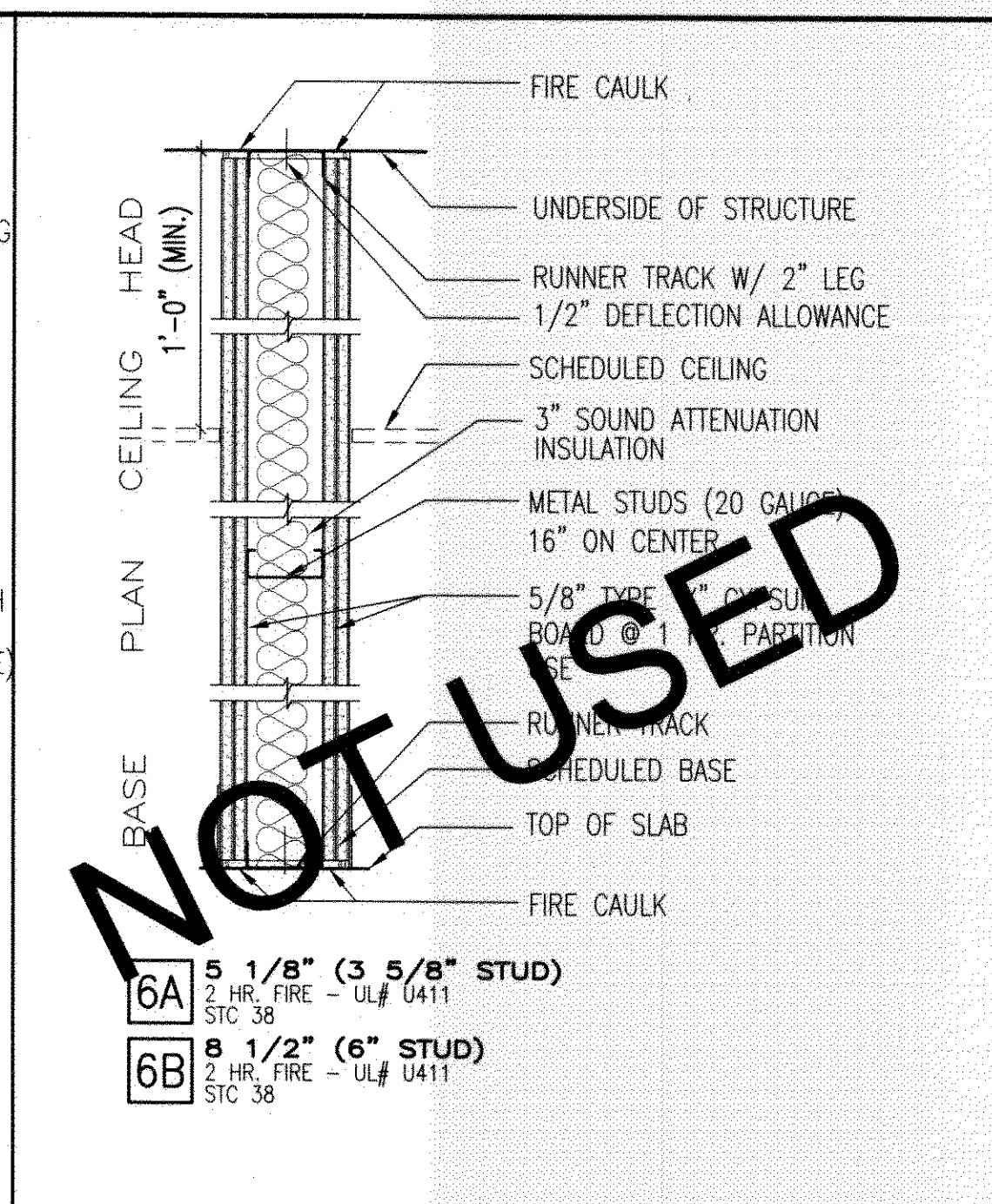

6 2-HR. RATED PARTITION WALL

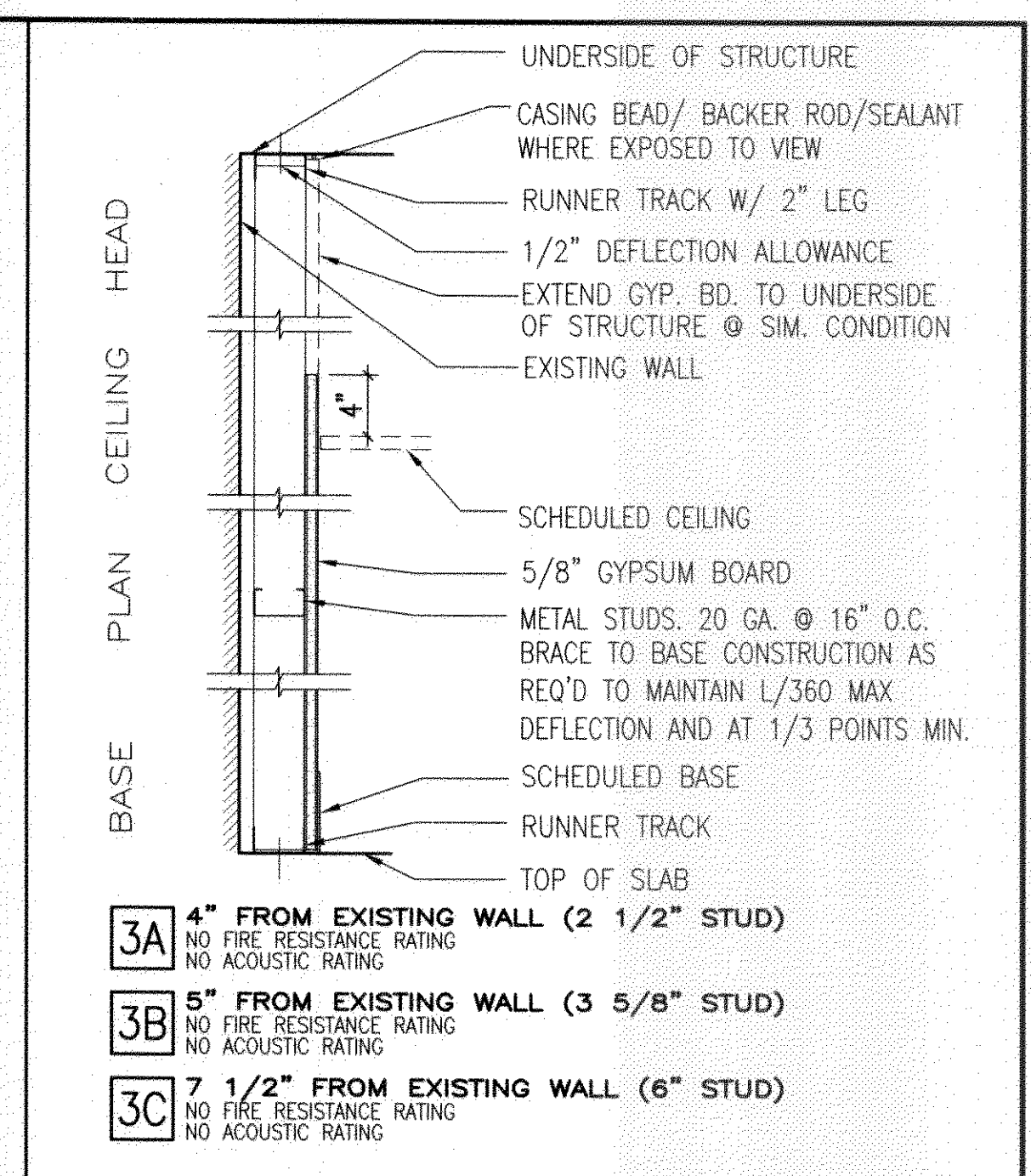

3 NEW PARTITION AT EXISTING WALL

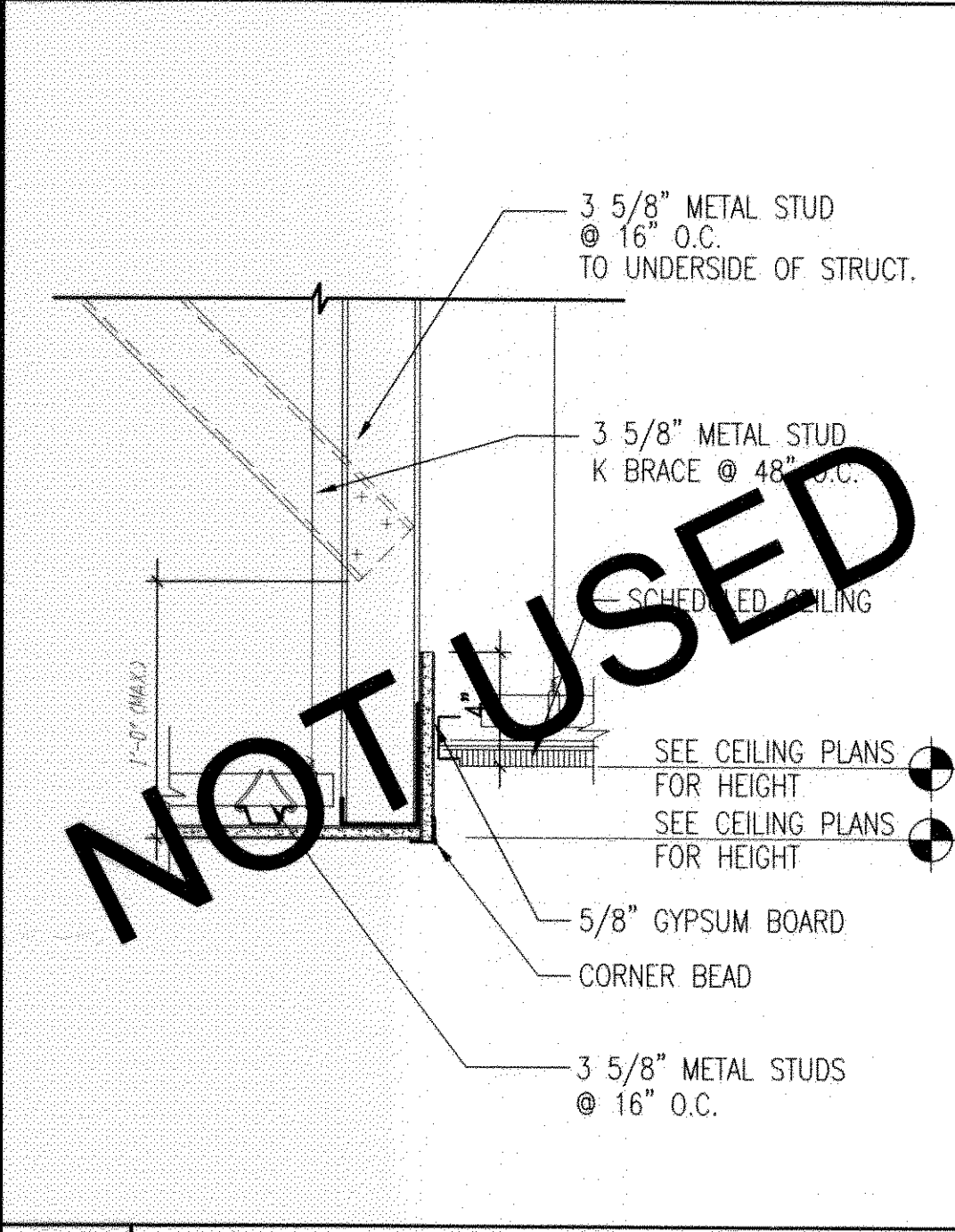

14 GYPSUM BOARD BULKHEAD

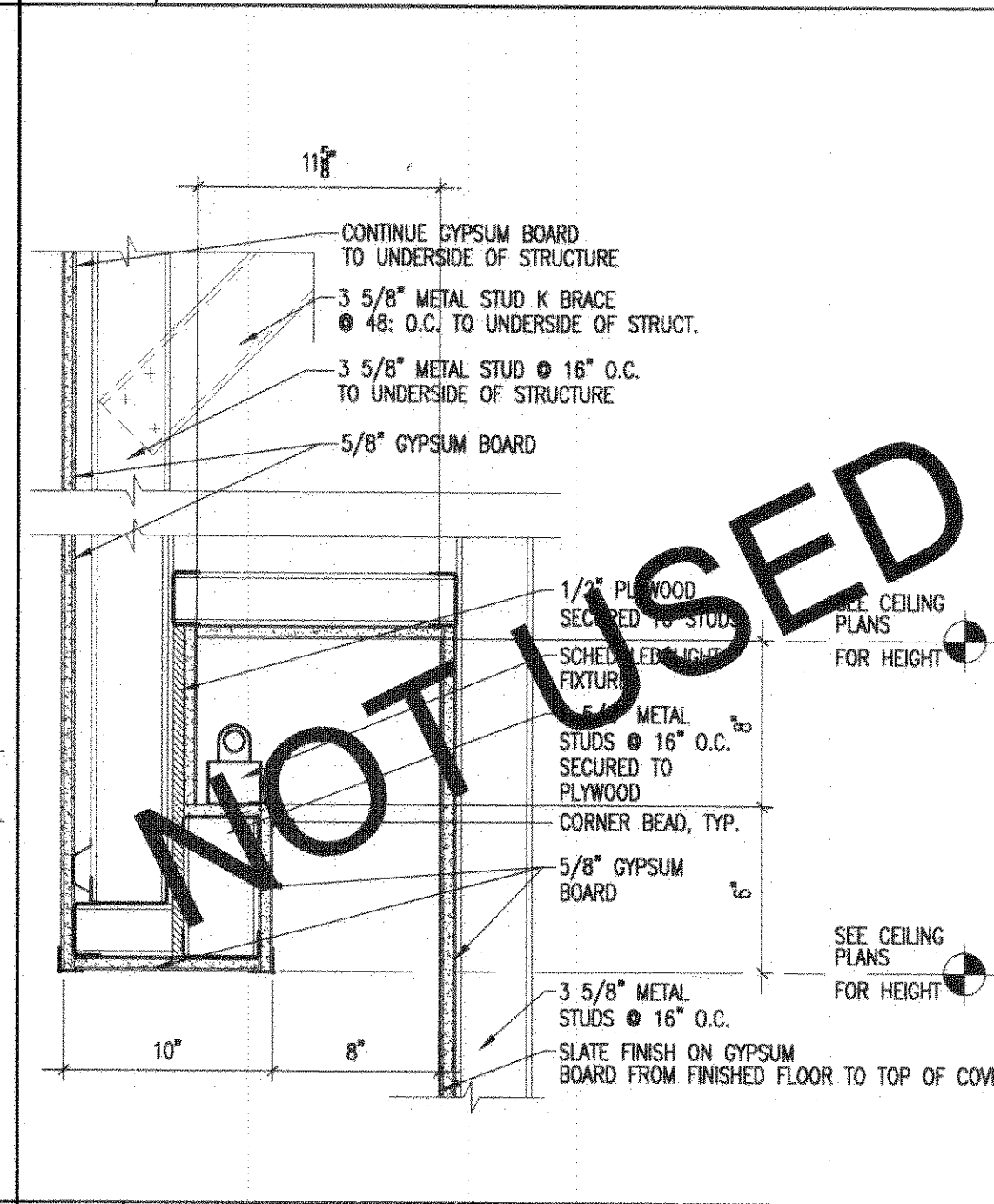

11 GYPSUM BOARD FASCIA/LIGHT COVE

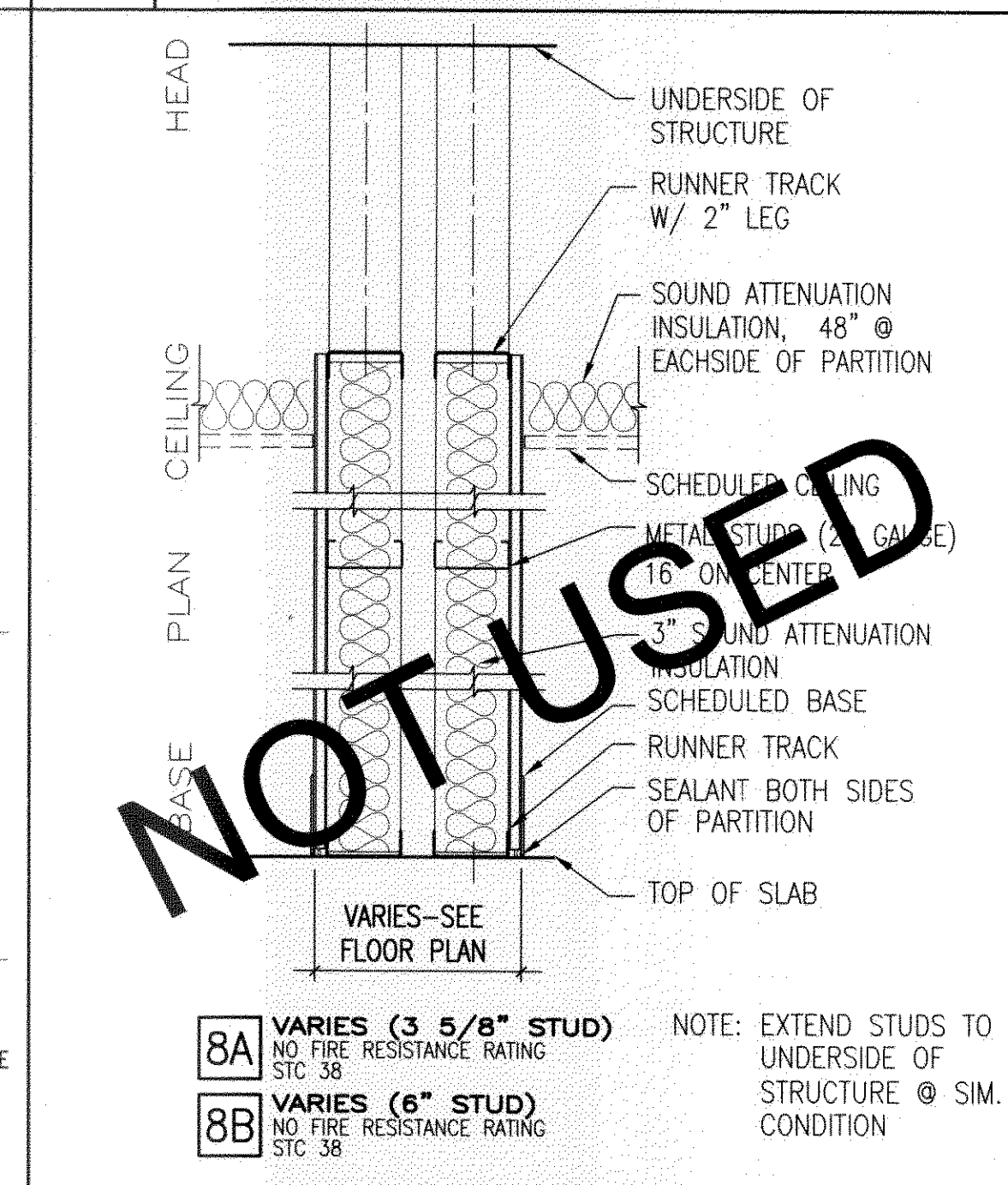

8 PLUMBING WALL

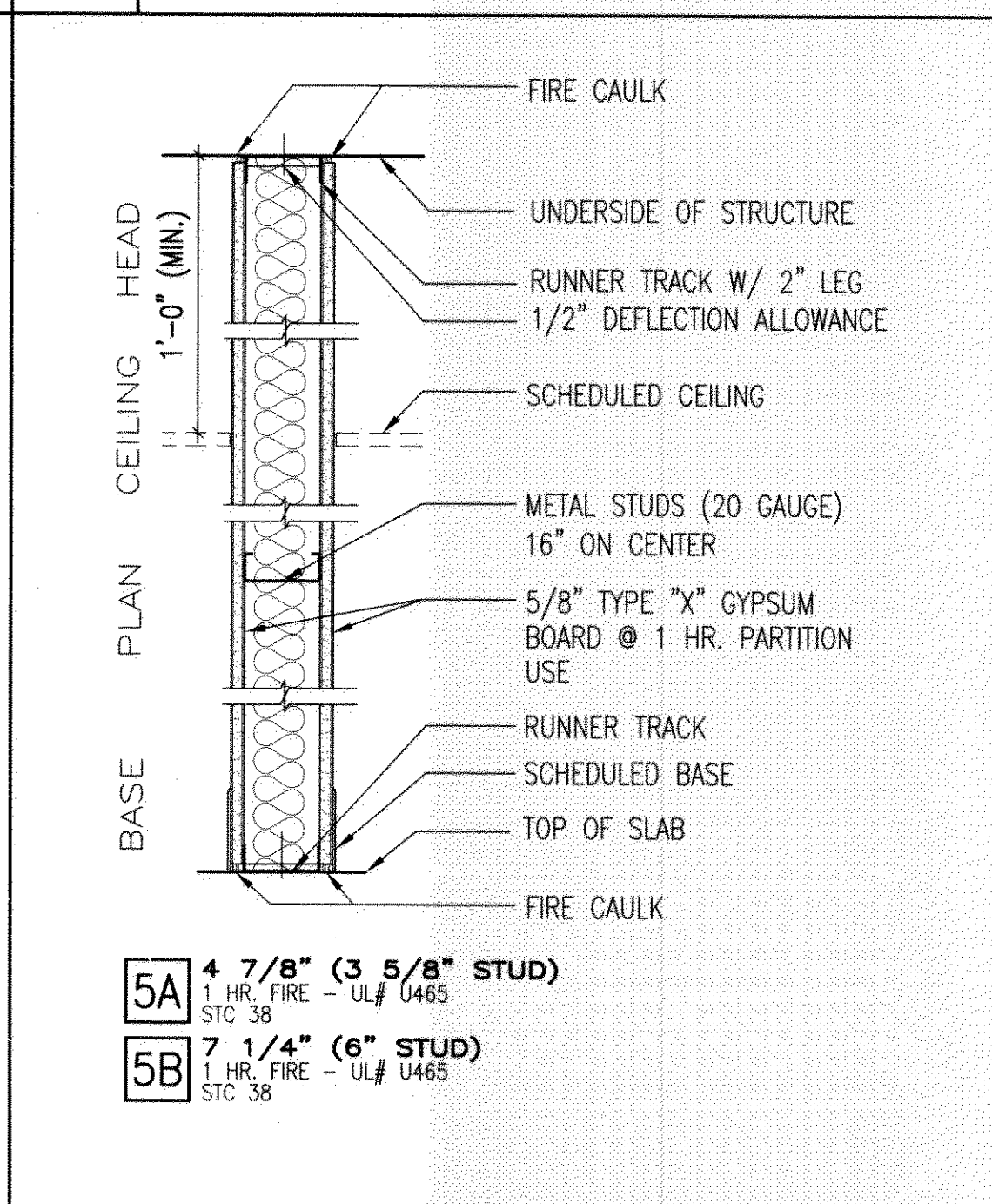

5 1-HR. RATED PARTITION WALL

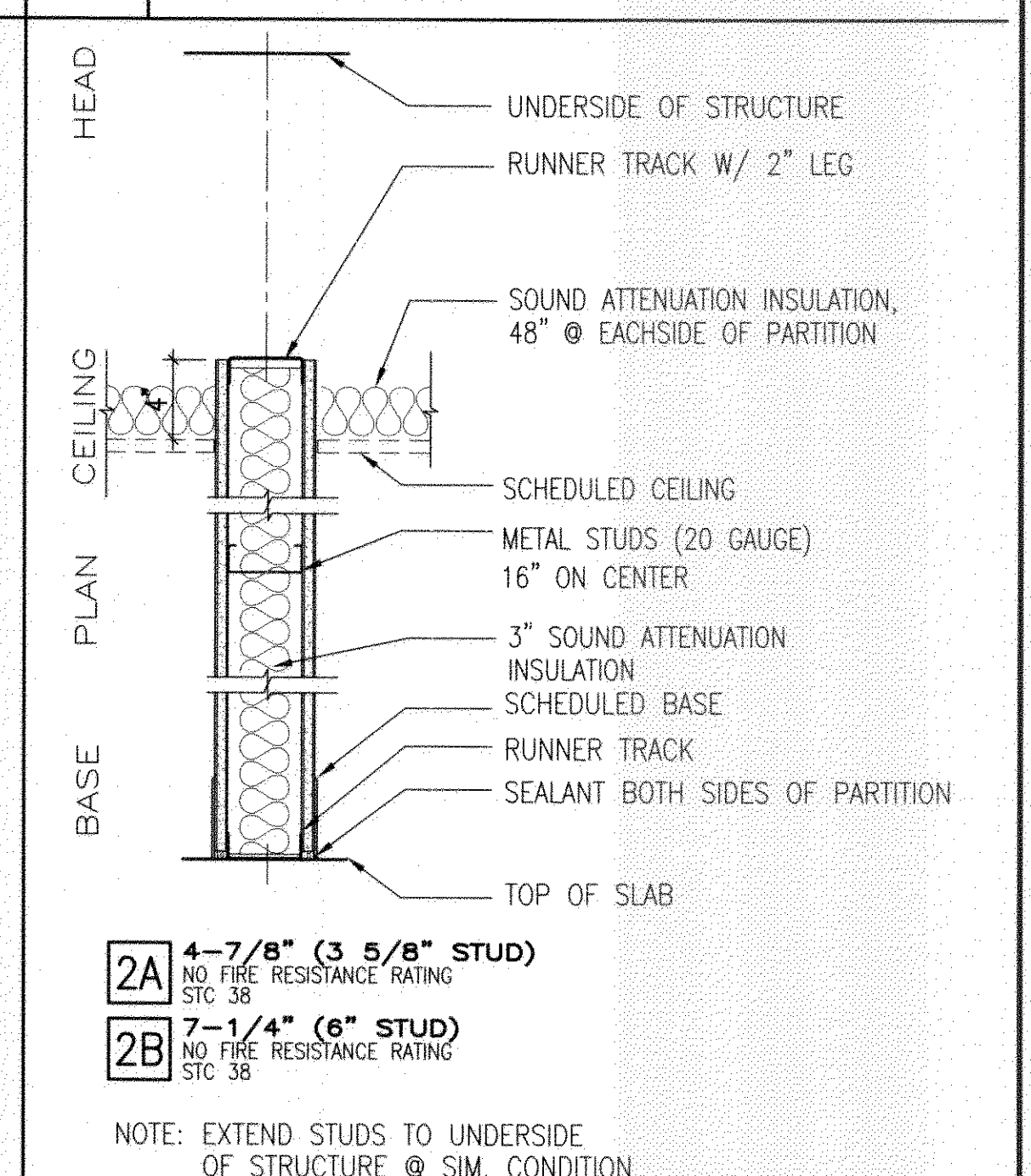

2 NEW PARTIAL HEIGHT PARTITION

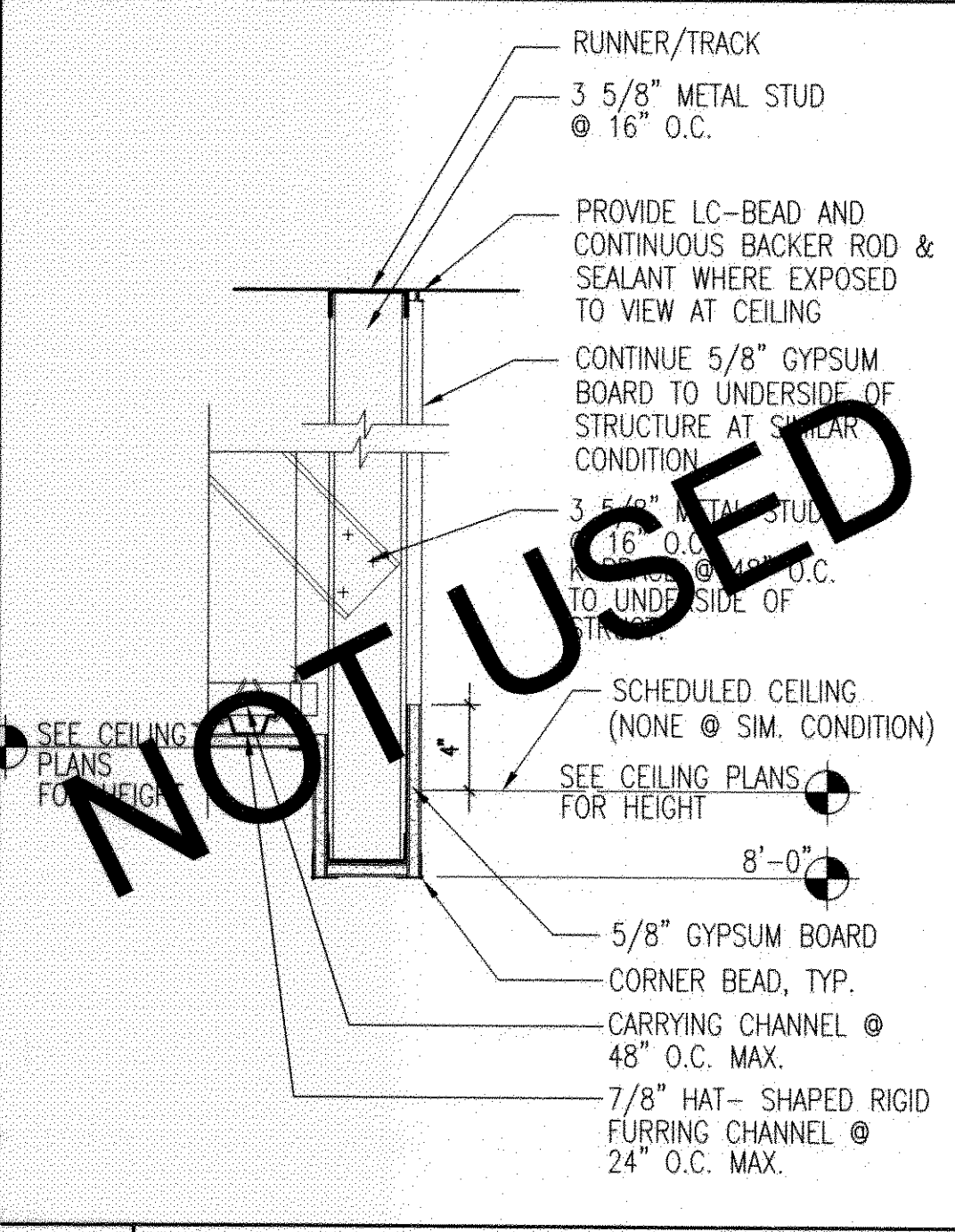

13 GYPSUM BOARD BULKHEAD

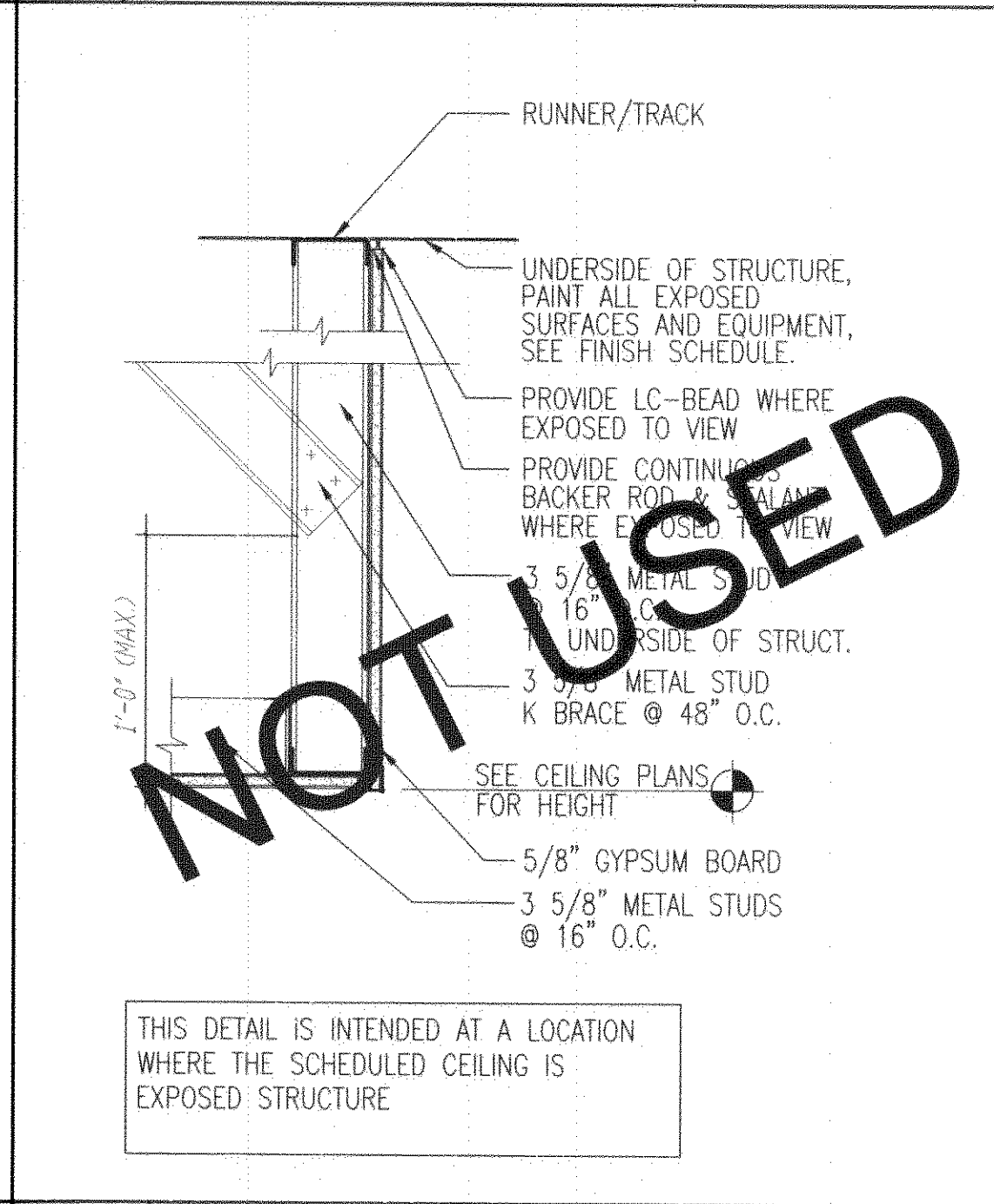

10 FASCIA/SOFFIT

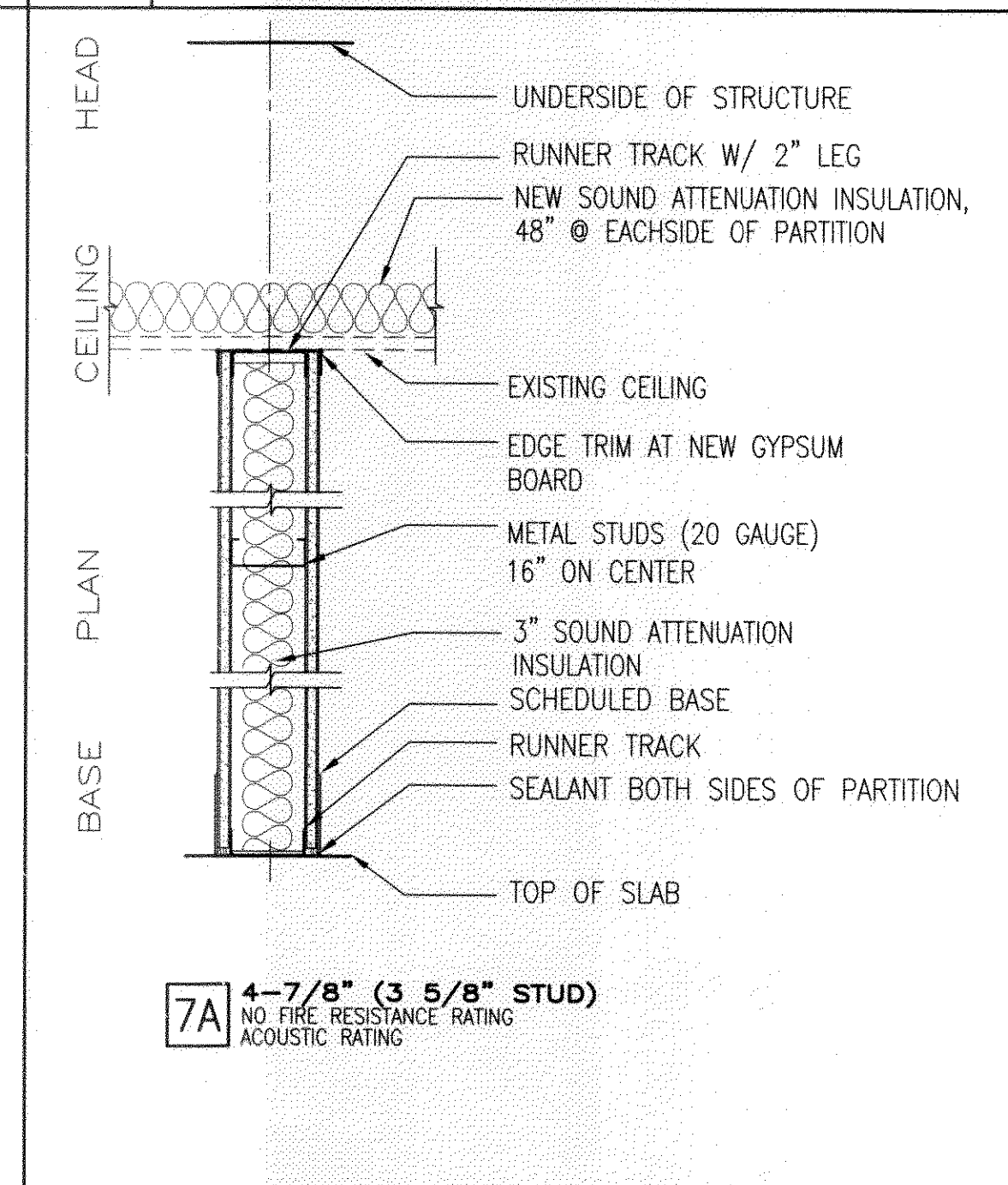

7 PARTIAL HEIGHT PARTITION WALL

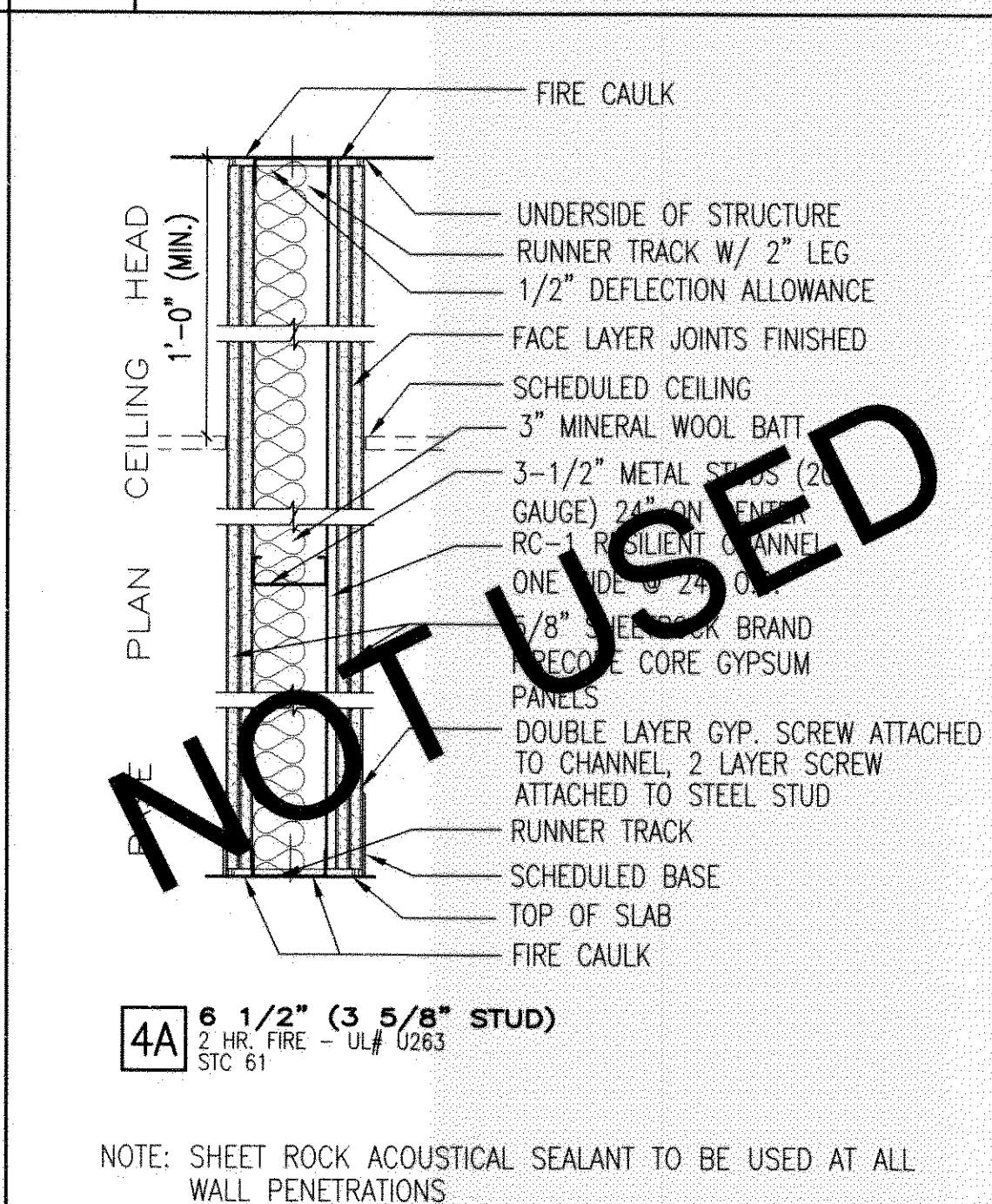

4 2-HR RATED FULL HEIGHT WALL

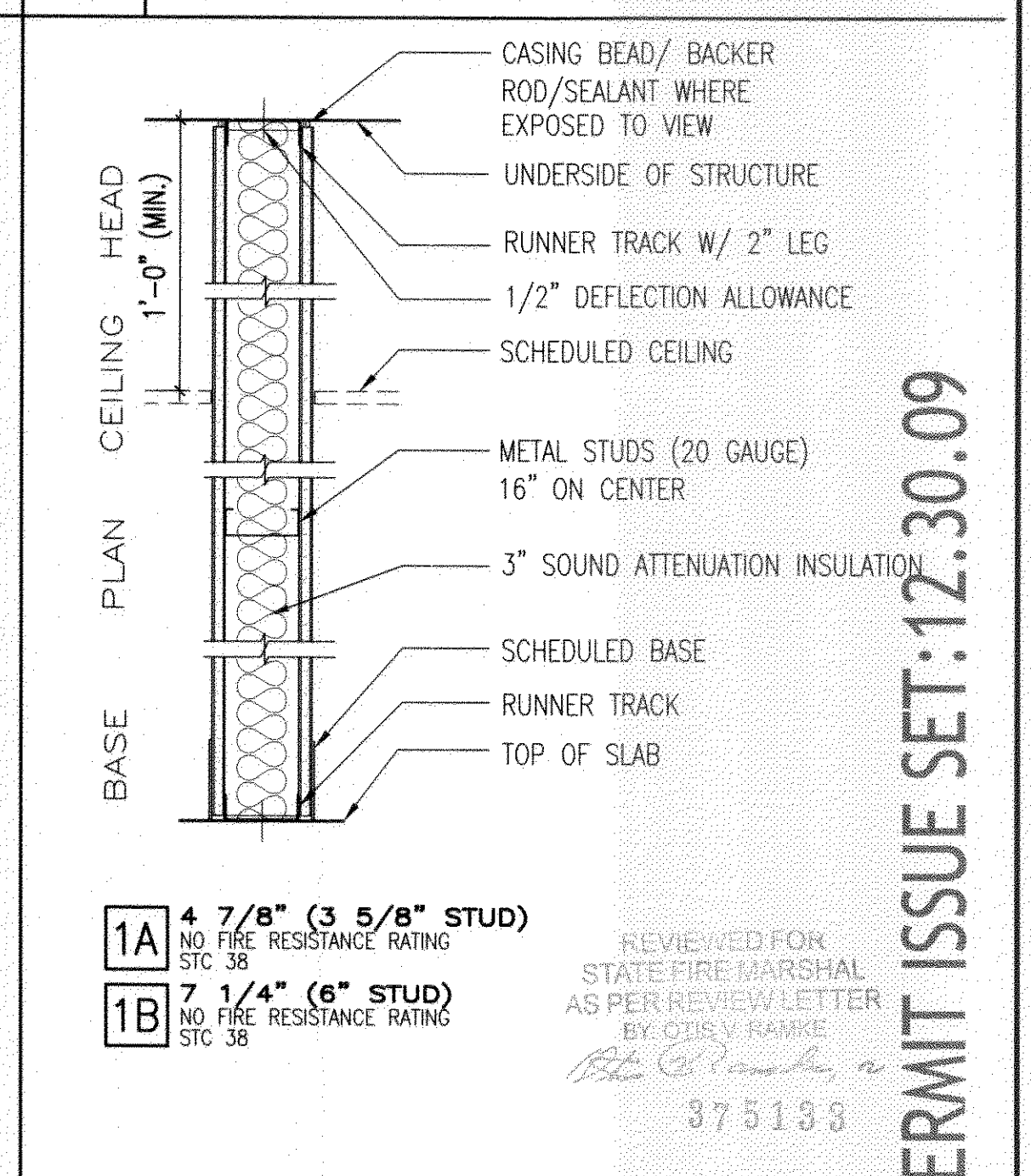

1 FULL HEIGHT PARTITION

ARCHITECTS OF RECORD:
 BRADFORD J. DUDLEY
 345 THIRD STREET
 LAGUNA BEACH, CALIFORNIA 92651
 T: 949.376.3076 F: 949.376.3078

PAUL MITCHELL
 PARTNER SCHOOL
 METAIRIE, LA
 3321 HESSMER AVENUE
 METAIRIE, LA 70002

CLIENT:
 MARK AND LISA PALERMO

PROFESSIONAL SEAL:
 BRADFORD J. DUDLEY
 REG. NO. 15257
 STATE OF LOUISIANA
 REGISTERED ARCHITECT
 SIGNATURE: [Signature] DATE: 12-24-2009

SUBMISSION	DATE
CONCEPT PLAN	12.01.09
CONSULTANT COORDINATION	12.14.09
PERMIT ISSUE SET	12.30.09

PROJECT NO: 0921
 SCALE: _____

WALL TYPES & CEILING/ BULKHEAD TYPES
 A 601

PERMIT ISSUE SET: 12.30.09