

- 1/2" GTPSUM R.D.
- 2-2x10 WD. FRM.
- 1/2" PLY WD.
- 1/2" x 5/4" WD. TRIM
- WD. BLOCK
- 1/2" WD. TRIM
- ALUM. DOOR FRAME

1.

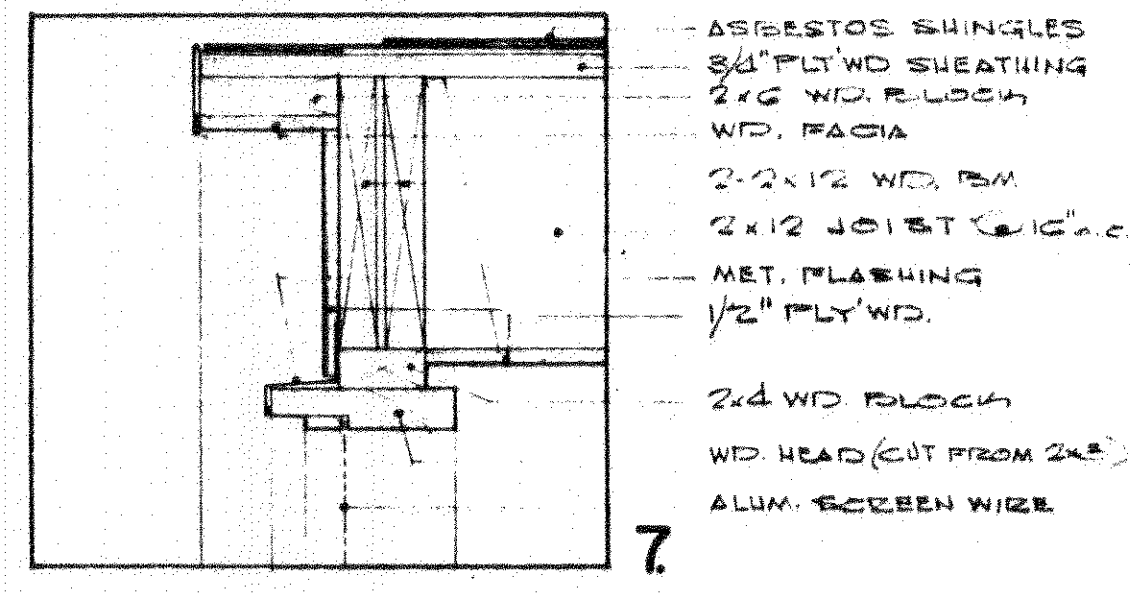

- ASBESTOS SHINGLES
- 3/4" PLY WD. SHEATHING
- 2x6 WD. BLOCK
- WD. FLASHING
- 2-2x12 WD. FRM.
- 2x12 JOIST @ 16" o.c.
- MET. FLASHING
- 1/2" PLY WD.
- 2x4 WD. BLOCK
- WD. HEAD (CUT FROM 2x6)
- ALUM. SCREEN WIRE

7.

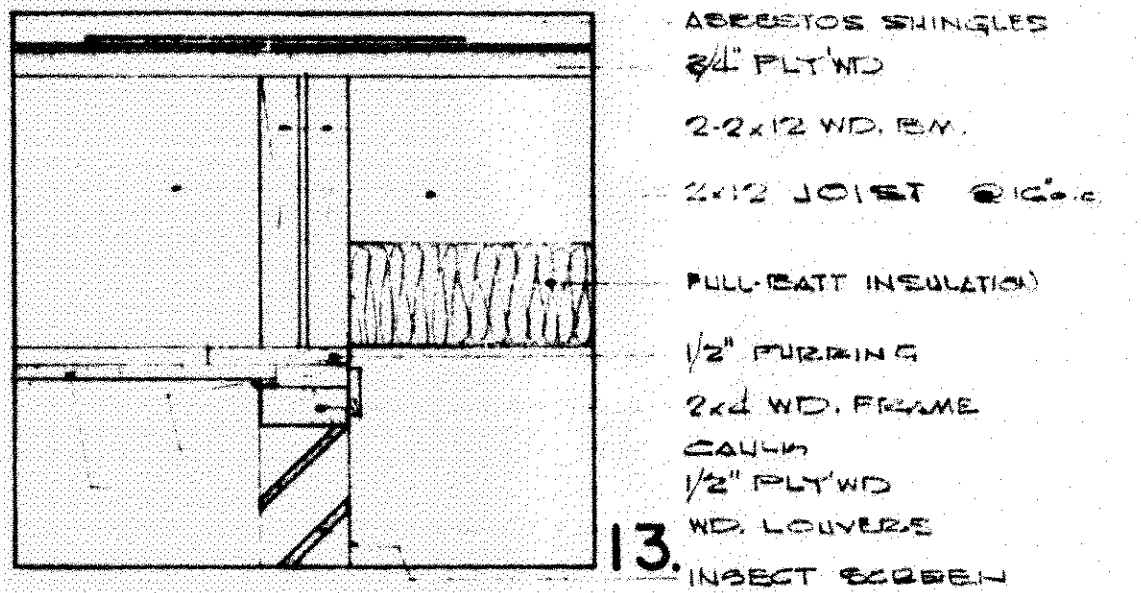

- ASBESTOS SHINGLES
- 3/4" PLY WD.
- 2-2x12 WD. FRM.
- 2x12 JOIST @ 16" o.c.
- FULL-BATT INSULATION
- 1/2" PURRING
- 2x4 WD. FRAME
- CAULK
- 1/2" PLY WD.
- WD. LOUVER
- INSECT SCREEN

13.

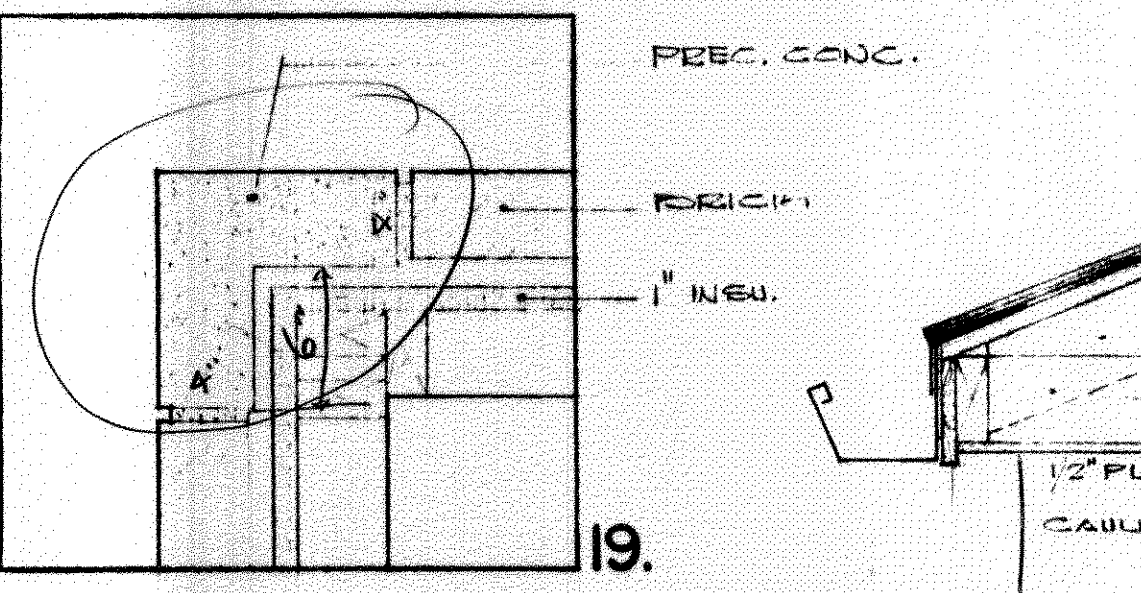

- PREC. CONC.
- BRICK
- 1" INSU.

19.

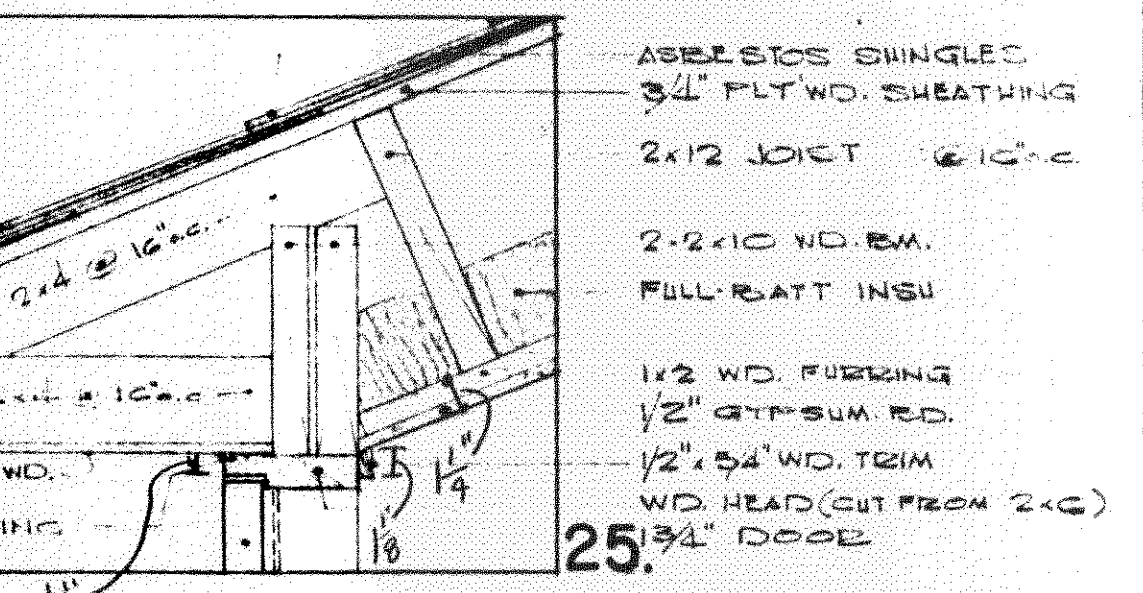

- ASBESTOS SHINGLES
- 3/4" PLY WD. SHEATHING
- 2x12 JOIST @ 16" o.c.
- 2-2x10 WD. FRM.
- FULL-BATT INSU.
- 1/2" WD. PURRING
- 1/2" GTPSUM R.D.
- 1/2" x 5/4" WD. TRIM
- WD. HEAD (CUT FROM 2x6)
- 3/4" DOOR

25.

25d. (similar but fixed glass)

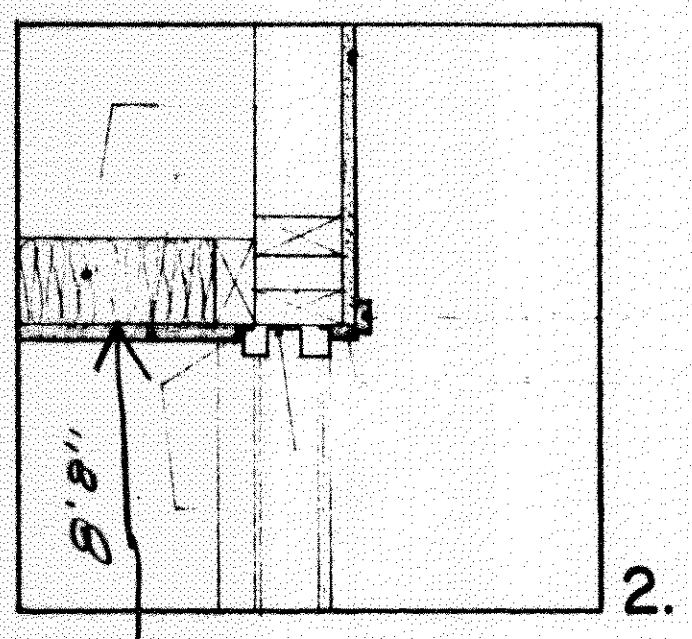

- 1/2" GTPSUM R.D.
- FULL-BATT INSU.
- 1/2" PLY WD.
- 1/2" x 5/4" WD. TRIM
- 1/2" WD. TRIM
- ALUM. WIND. FRAME
- CAULKING

2.

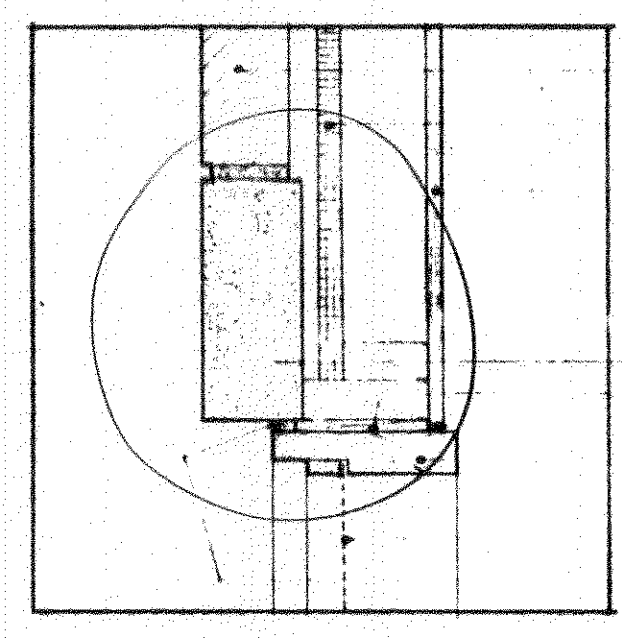

- BRICK
- 25/32" SHEATHING
- 1/2" PLY WD.
- PREC. CONC.
- 1/2" WD. JAMB
- WD. JAMB (CUT FROM 2x6)
- ALUM. SCREEN WIRE
- CAULK

8.

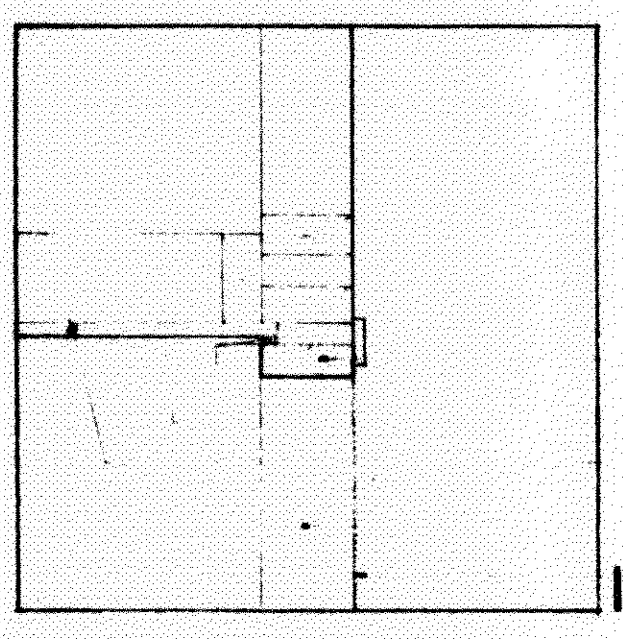

- 2x4 WD. FRAME
- CAULK
- 1/2" PLY WD.
- WD. LOUVER
- INSECT SCREEN

14.

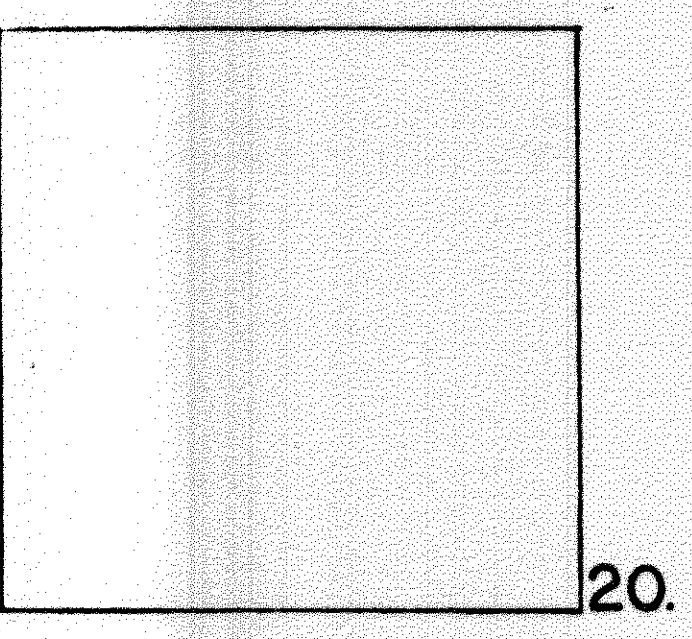

- 2x4 WD. FRAME
- CAULK
- 1/2" PLY WD.
- WD. LOUVER
- INSECT SCREEN

20.

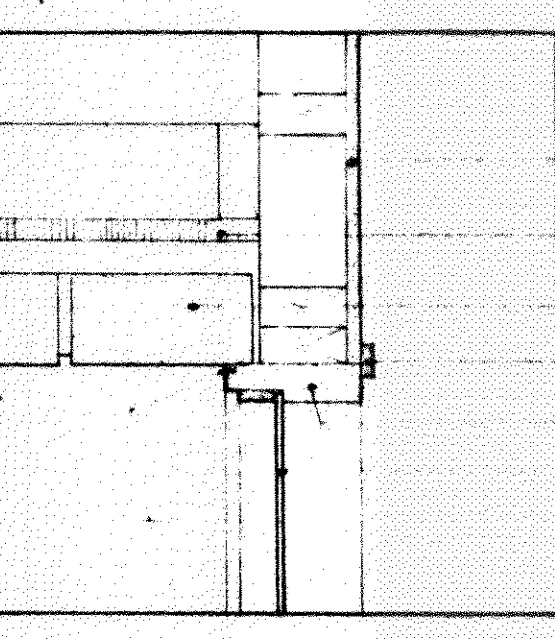

- 1/2" GTPSUM R.D.
- 25/32" SHEATHING
- BRICK
- 1/2" x 5/4" WD. TRIM
- WD. JAMB (CUT FROM 2x6)
- 7/32" CRTS. SH. GL.
- CAULKING

26.

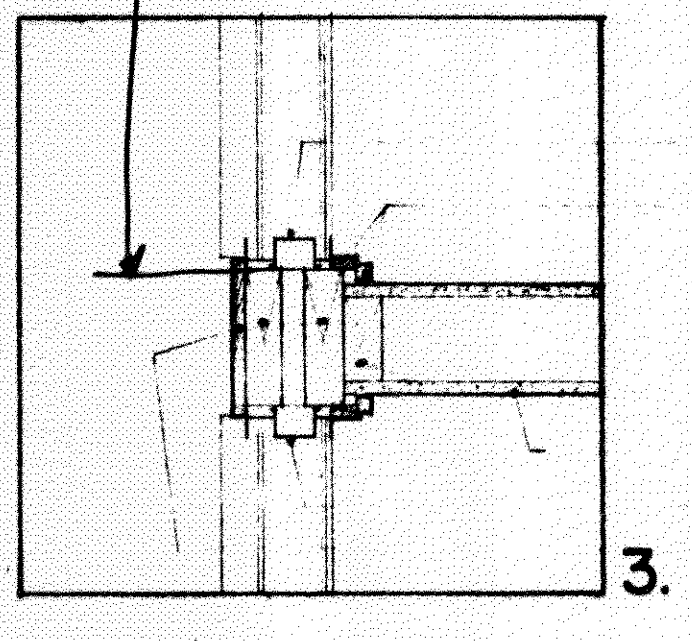

- ALUM. DOOR FRAME
- 1/2" WD. TRIM
- 2-2x6
- 2x4
- 1/2" GTPSUM R.D.
- ALUM. DOOR FRAME
- 1/2" WD. TRIM

3.

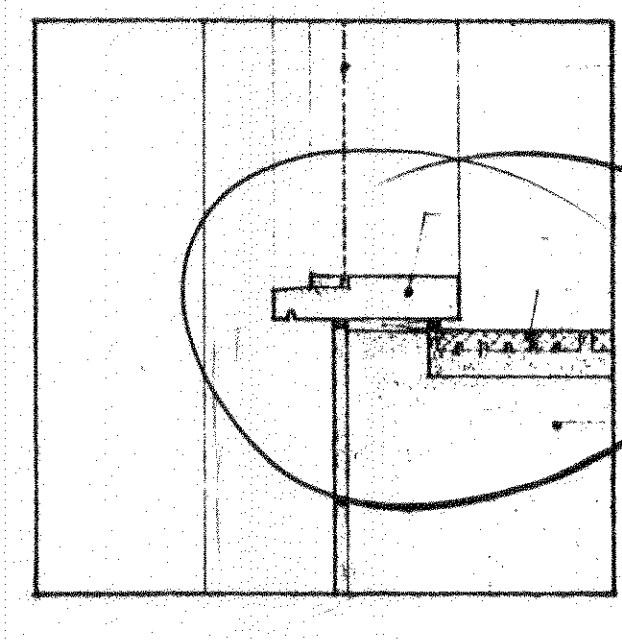

- ALUM. SCREEN WIRE
- WD. SILL (CUT FROM 2x6)
- QUARRY TILE
- CONC. SLAB
- 1/2" PLY WD.

9.

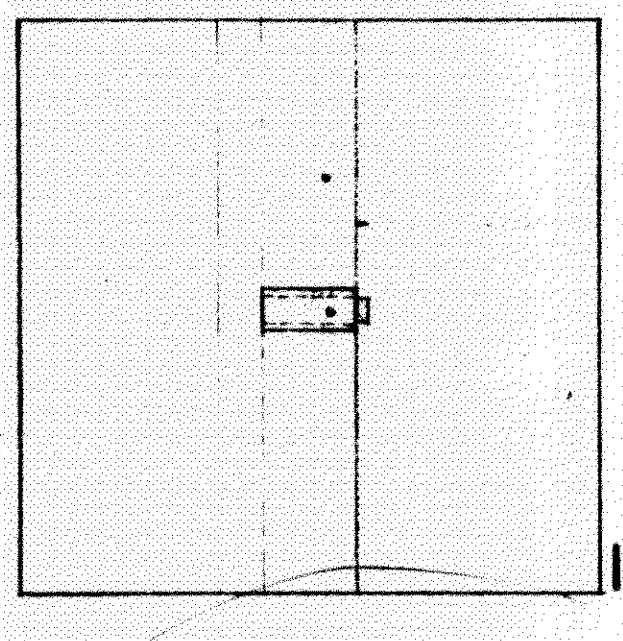

- WD. LOUVER
- INSECT SCREEN
- 2x4 WD. MULLION

15.

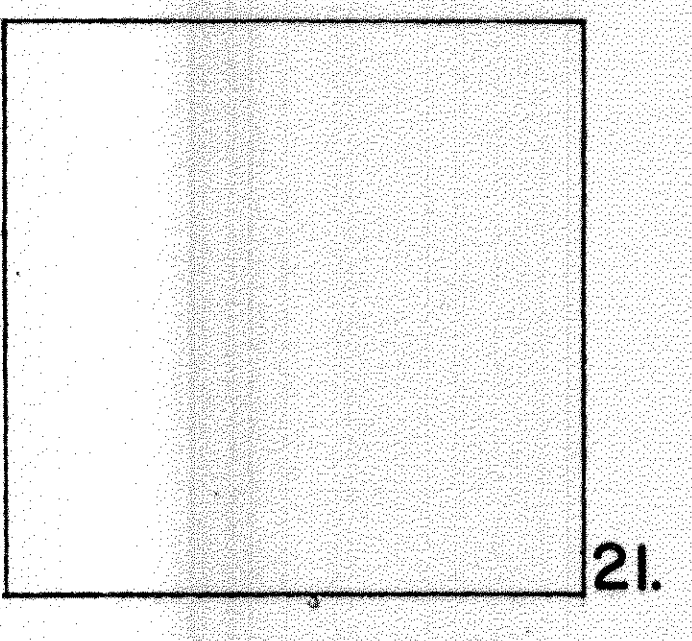

- WD. LOUVER
- INSECT SCREEN
- 2x4 WD. MULLION

21.

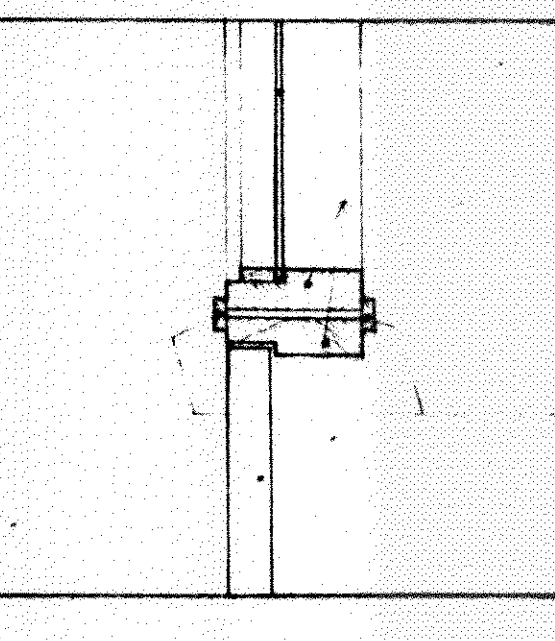

- 7/32" CRTS. SH. GL.
- WD. MULLION (CUT FROM 2x6)
- 1/2" x 5/4" WD. TRIM
- 1 3/4" WD. DOOR

27.

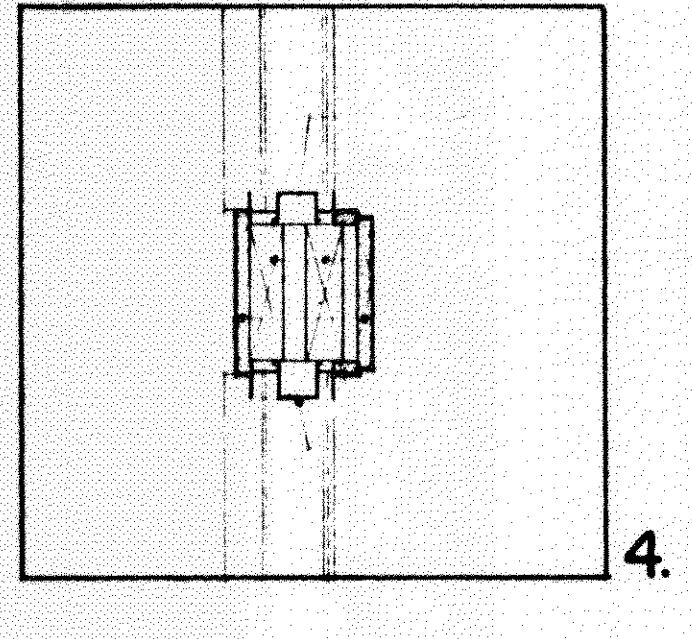

- ALUM. DOOR FRAME
- 2-2x6
- 1/2" WD. TRIM
- ALUM. DOOR FRAME

4.

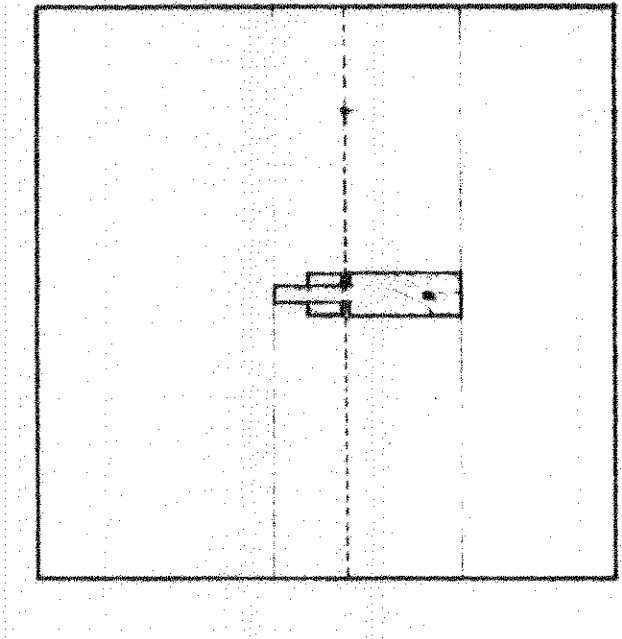

- ALUM. SCREEN WIRE
- WD. MULLION (CUT FROM 2x6)

10.

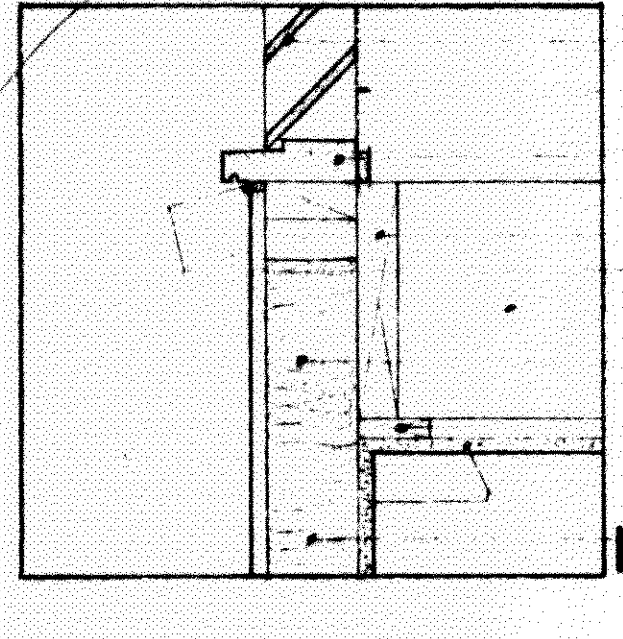

- WD. LOUVER
- INSECT SCREEN
- WD. SILL (CUT FROM 2x6)
- 2x10
- CAULK
- 2x10 CLR. JOIST @ 16" o.c.
- 2x4 STUDS @ 16" o.c.
- 1/2" WD. PURRING
- 1/2" GTPSUM R.D.
- FULL-BATT INSU.

16.

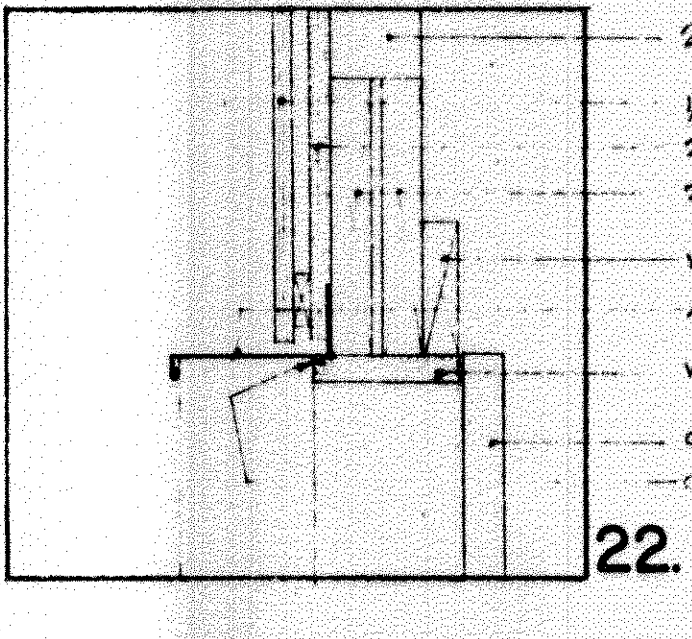

- 2x4 STUDS @ 16" o.c.
- 1/2" PLY WD.
- 25/32" SHEATHING
- 2-2x10
- WD. FLASHING
- MET. FLASHING
- WD. TRIM
- OVERHEAD DOOR
- CAULK

22.

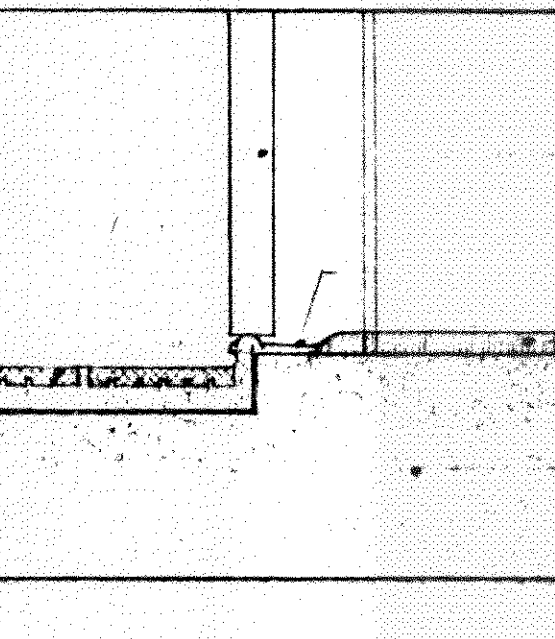

- 1 3/4" DOOR
- QUARRY TILE
- ALUM. TRIM
- CARPET (BY OWNER)
- CONC. SLAB

28.

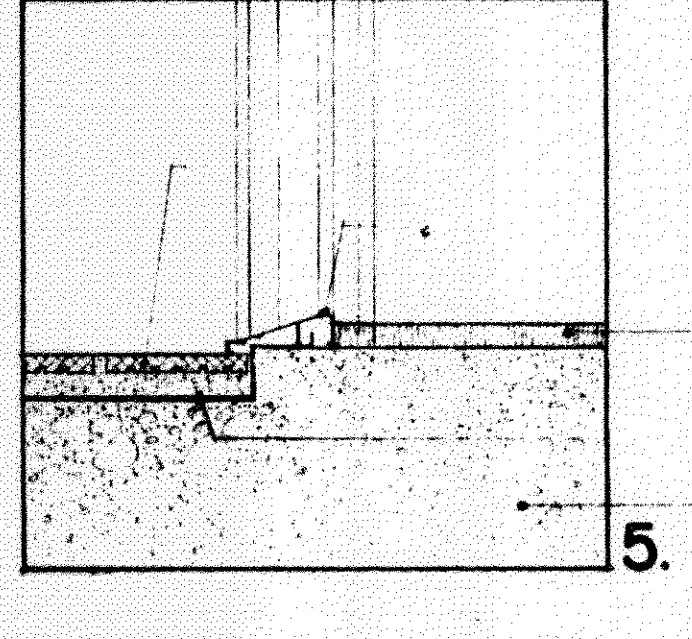

- QUARRY TILE
- ALUM. DOOR FRAME
- CARPET (BY OWNER)
- MET. PAN
- CONC. SLAB

5.

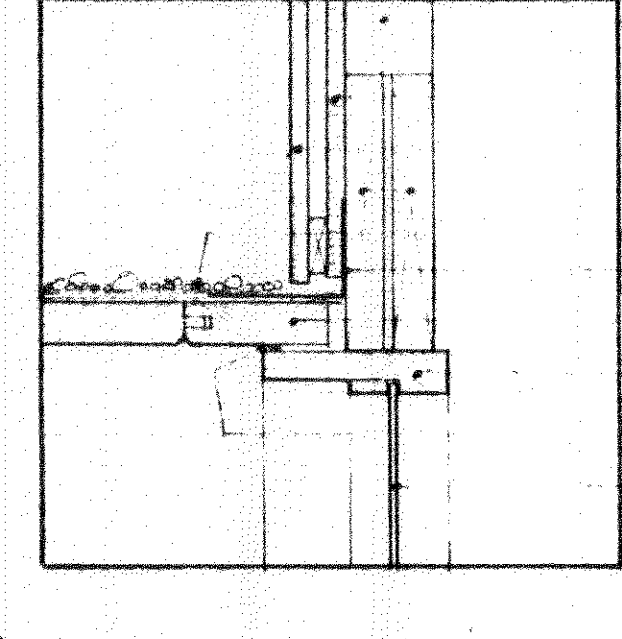

- 2x4 STUDS @ 16" o.c.
- 25/32" SHEATHING
- 1/2" PLY WD.
- 2-2x10
- BUILT-UP ROOF
- MET. FLASHING
- 2x6 1x6 WD. DECK
- WD. HEAD (CUT FROM 2x6)
- CAULK
- 7/32" CRTS. SH. GL.

11.

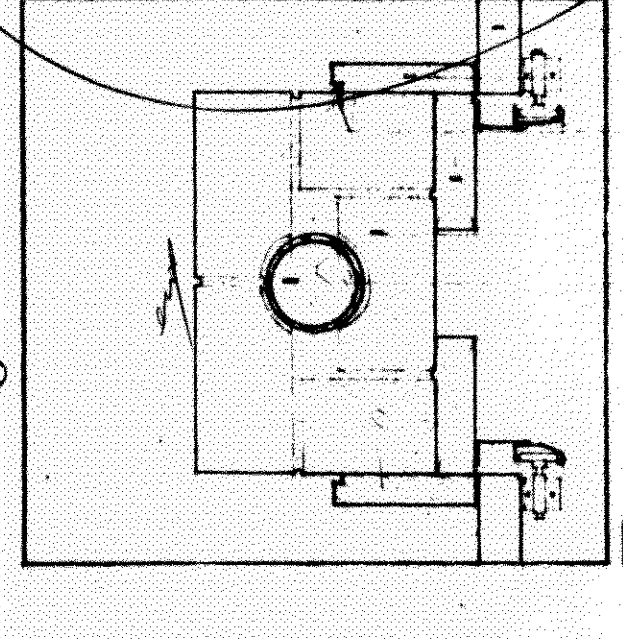

- OVERHEAD DOOR
- WD. TRIM
- CAULK
- WD. BLOCK
- BRICK
- PIPE COL. (SEE STRUCT.)

17.

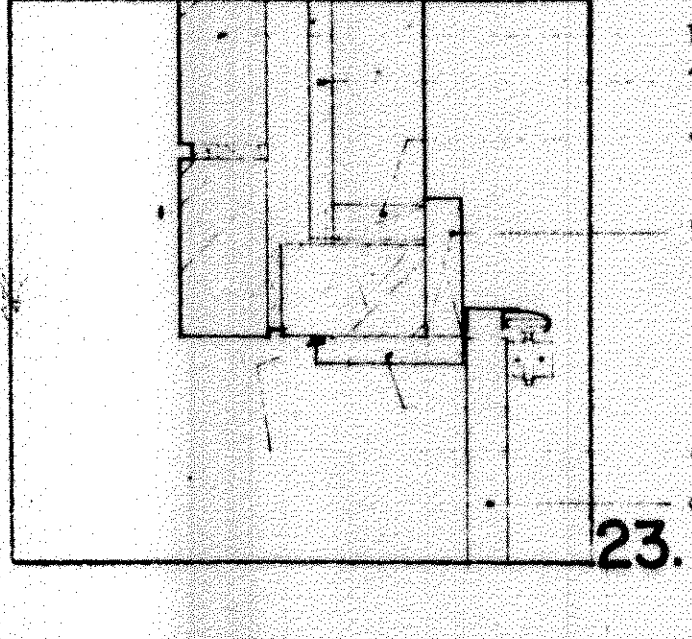

- BRICK
- 25/32" SHEATHING
- 2x4 STUDS
- WD. FLASHING
- WD. TRIM
- CAULK
- OVERHEAD DOOR

23.

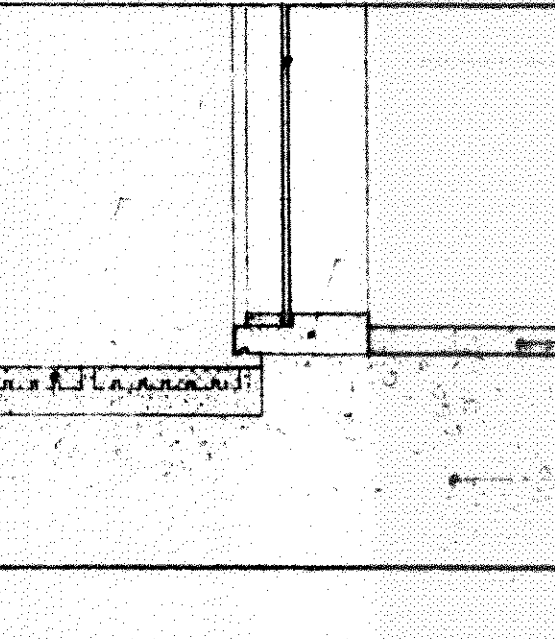

- 7/32" CRTS. SH. GL.
- QUARRY TILE
- WD. SILL (CUT FROM 2x6)
- CARPET (BY OWNER)
- CONC. SLAB

29.

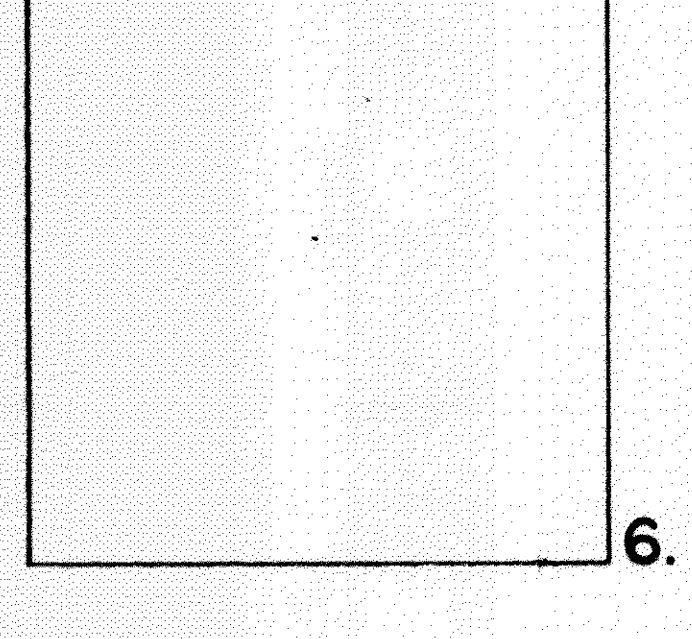

- 2x4 STUDS @ 16" o.c.
- 25/32" SHEATHING
- 1/2" PLY WD.
- 2-2x12
- BUILT-UP ROOF
- MET. FLASHING
- 2x6 1x6 WD. DECK
- WD. HEAD (CUT FROM 2x6)
- CAULK
- 1 3/4" WD. DOOR

6.

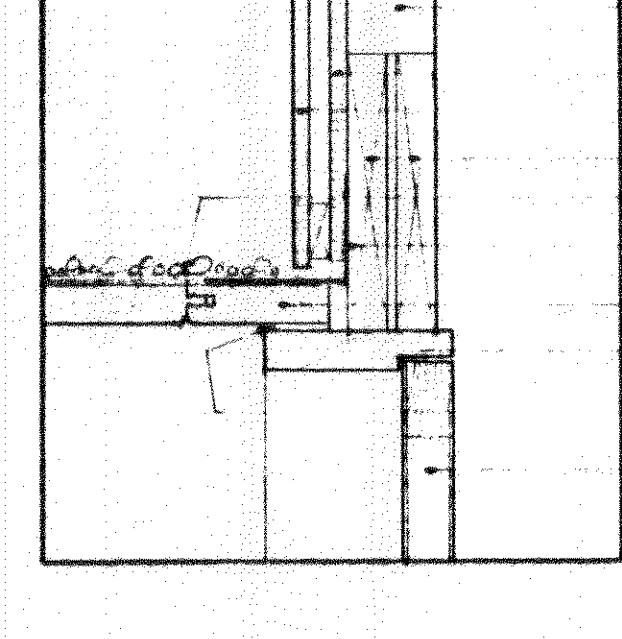

- 2x4 STUDS @ 16" o.c.
- 25/32" SHEATHING
- 1/2" PLY WD.
- 2-2x12
- BUILT-UP ROOF
- MET. FLASHING
- 2x6 1x6 WD. DECK
- WD. HEAD (CUT FROM 2x6)
- CAULK
- 1 3/4" WD. DOOR

12.

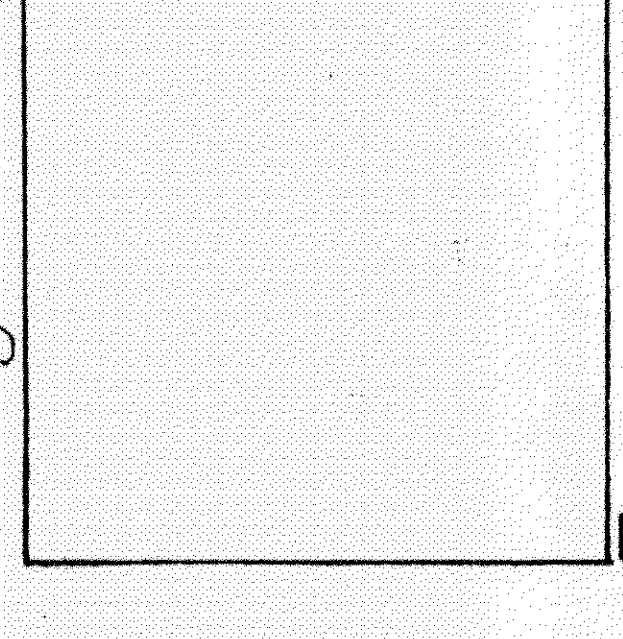

- OVERHEAD DOOR
- WD. TRIM
- CAULK
- WD. BLOCK
- BRICK
- PIPE COL. (SEE STRUCT.)

18.

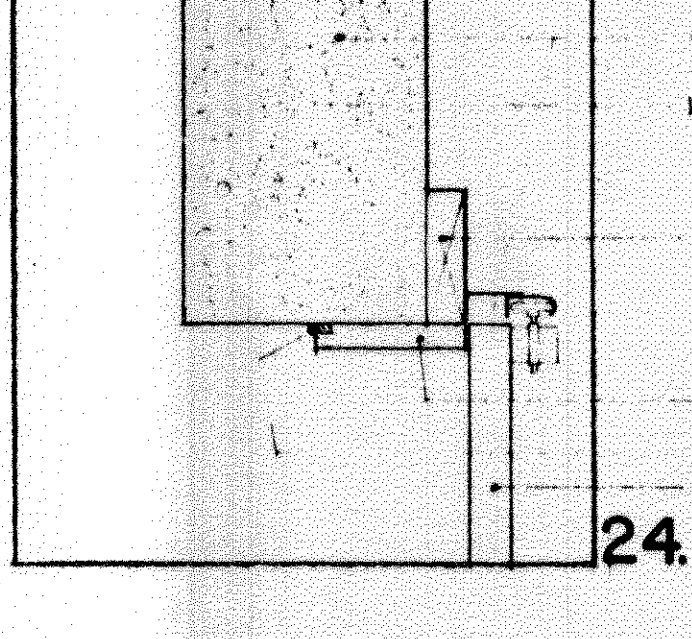

- CONC. CHAIN WALL
- LINE OF BRICK ABOVE
- WD. LOCK
- WD. TRIM
- CAULK
- OVERHEAD DOOR

24.



- 7/32" CRTS. SH. GL.
- QUARRY TILE
- WD. SILL (CUT FROM 2x6)
- CARPET (BY OWNER)
- CONC. SLAB

30.

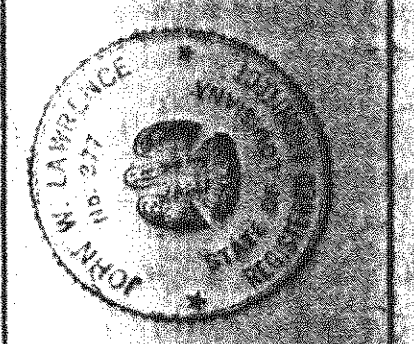

our lady of lourdes catholic church and rectory  
 Slidell, Louisiana  
 architects  
 Metairie, Louisiana

sheet no. **A-25**  
 date 1-12-51  
 scale 1/4" = 1'-0"  
 drawn JWB  
 checked JWC  
 revised