

16 PREP ROOM ELEVATION
SCALE: 1/4"=1'-0"

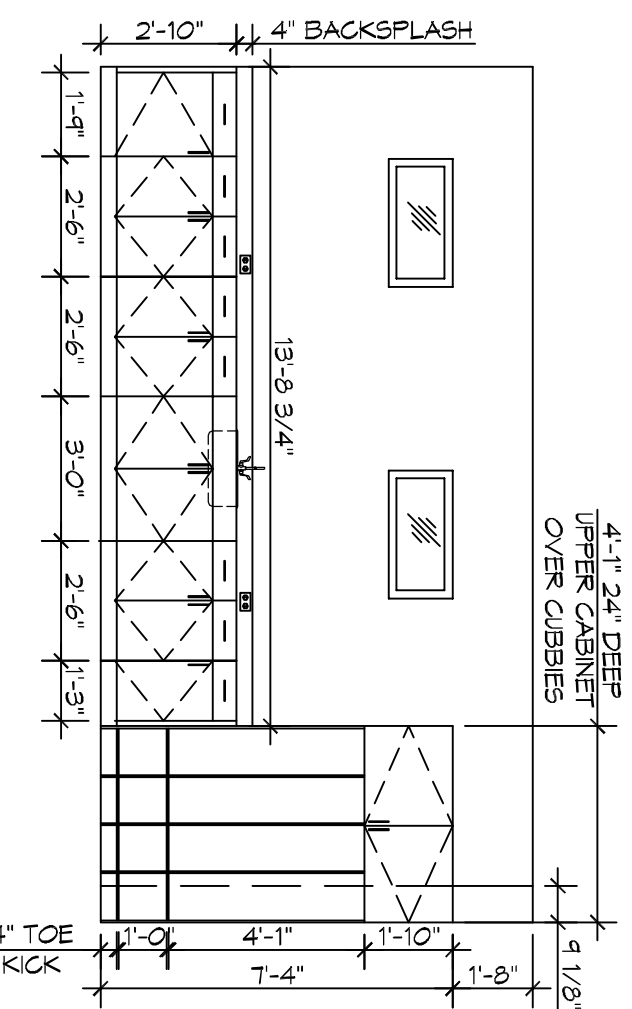

17 HOLDING/COSMETIZING ELEVATION
SCALE: 1/4"=1'-0"

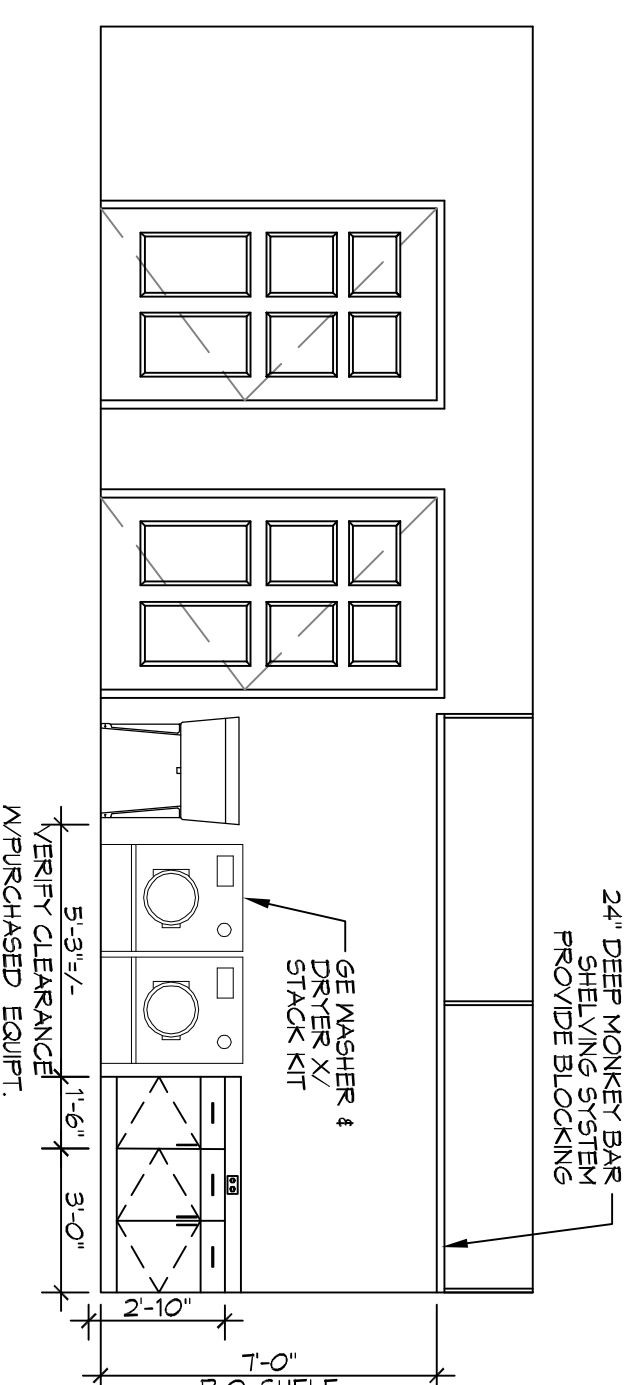

18 HOLDING/COSMETIZING ELEVATION
SCALE: 1/4"=1'-0"

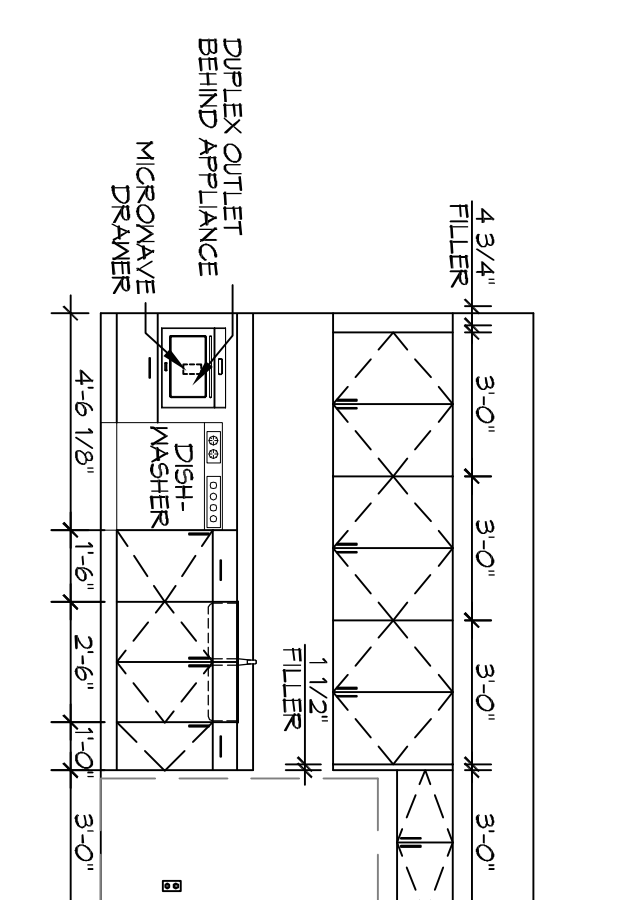

19 BREAK ROOM ELEVATION
SCALE: 1/4"=1'-0"

- REFERENCE NOTES**
1. REFER TO DESIGN STANDARDS FOR REQUIREMENTS RELATED TO THIS SHEET. CONTRACTOR IS RESPONSIBLE FOR BUILDING STANDARDS.
 2. REFER TO FINE DRAWINGS FOR THE FINISHES & EQUIPMENT REQUIREMENTS. FINE IS NOT COMPLETED BY DAMMON ENGINEERING AND WILL BE SUBMITTED BY OWNER.

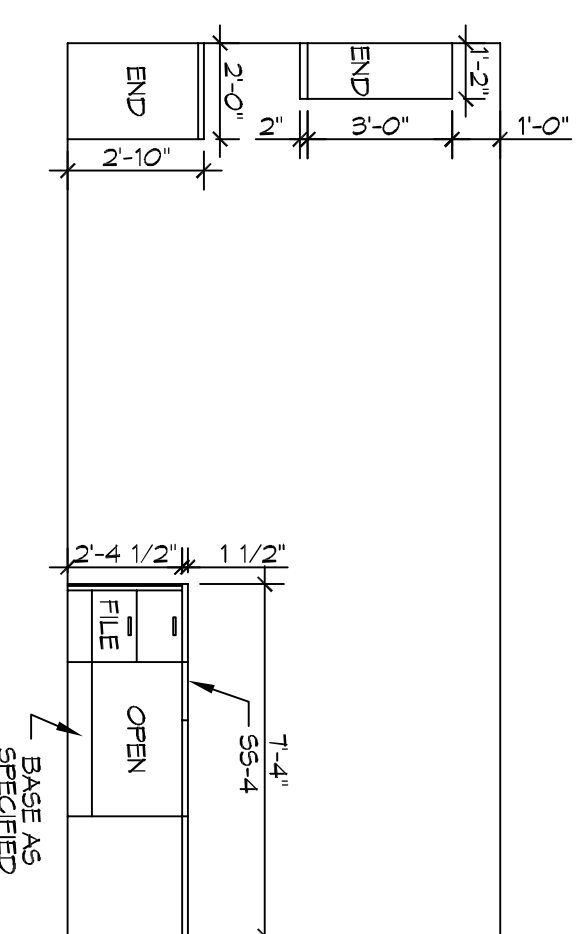

11 FUNERAL DIRECTOR ELEVATION
SCALE: 1/4"=1'-0"

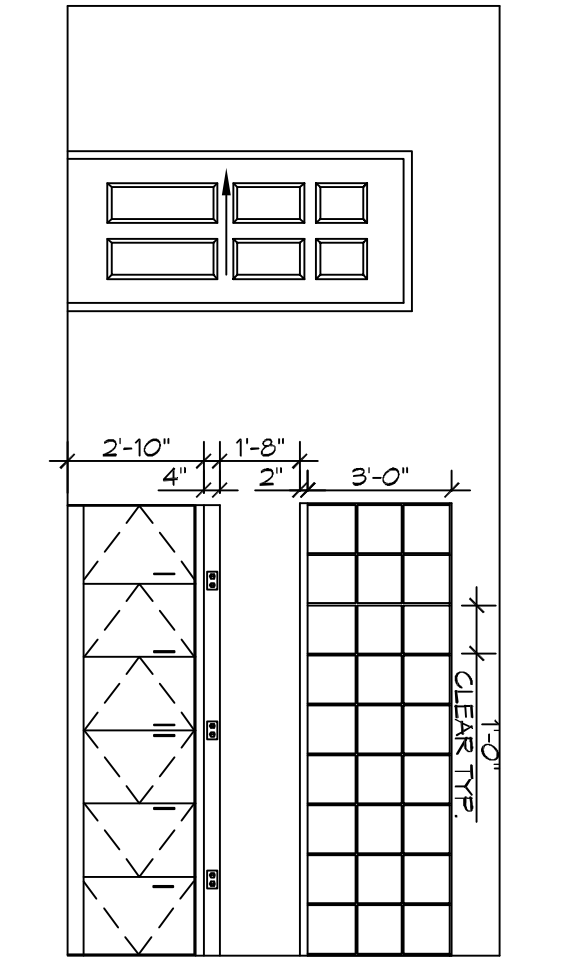

12 FUNERAL DIRECTOR ELEVATION
SCALE: 1/4"=1'-0"

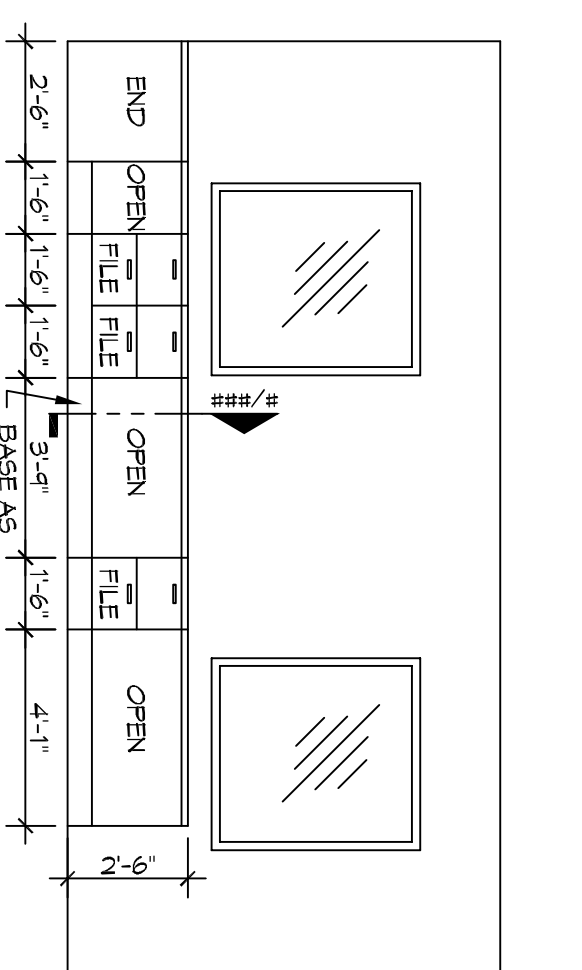

13 FUNERAL DIRECTOR ELEVATION
SCALE: 1/4"=1'-0"

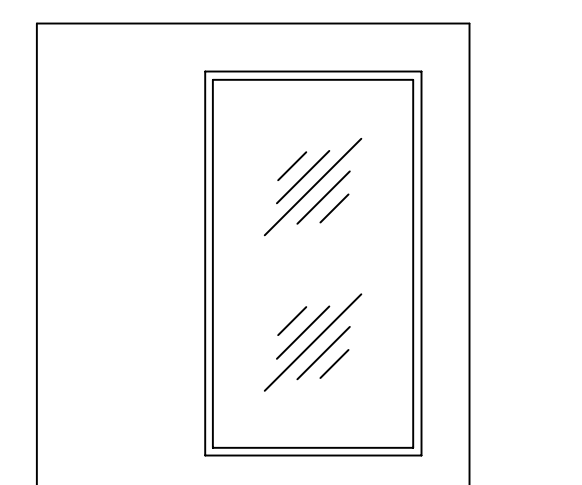

14 VIEWING ROOM ELEVATION
SCALE: 1/4"=1'-0"

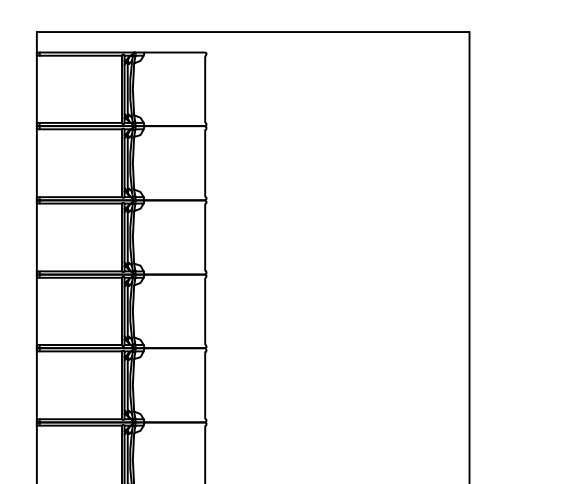

15 VIEWING ROOM ELEVATION
SCALE: 1/4"=1'-0"

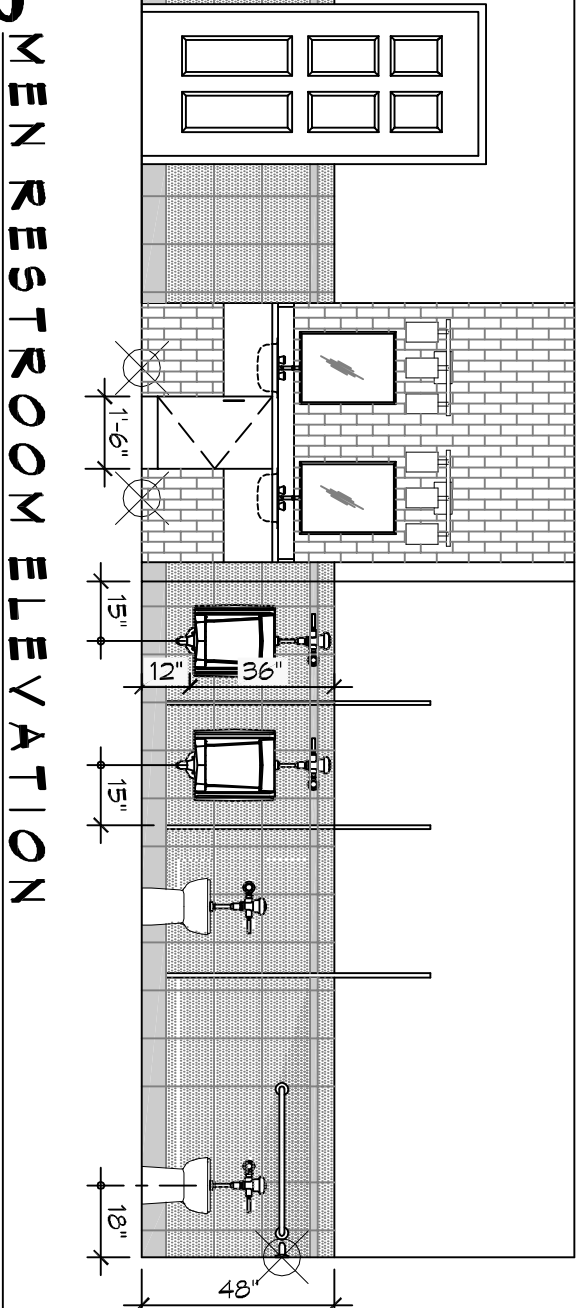

6 MEN RESTROOM ELEVATION
SCALE: 1/4"=1'-0"

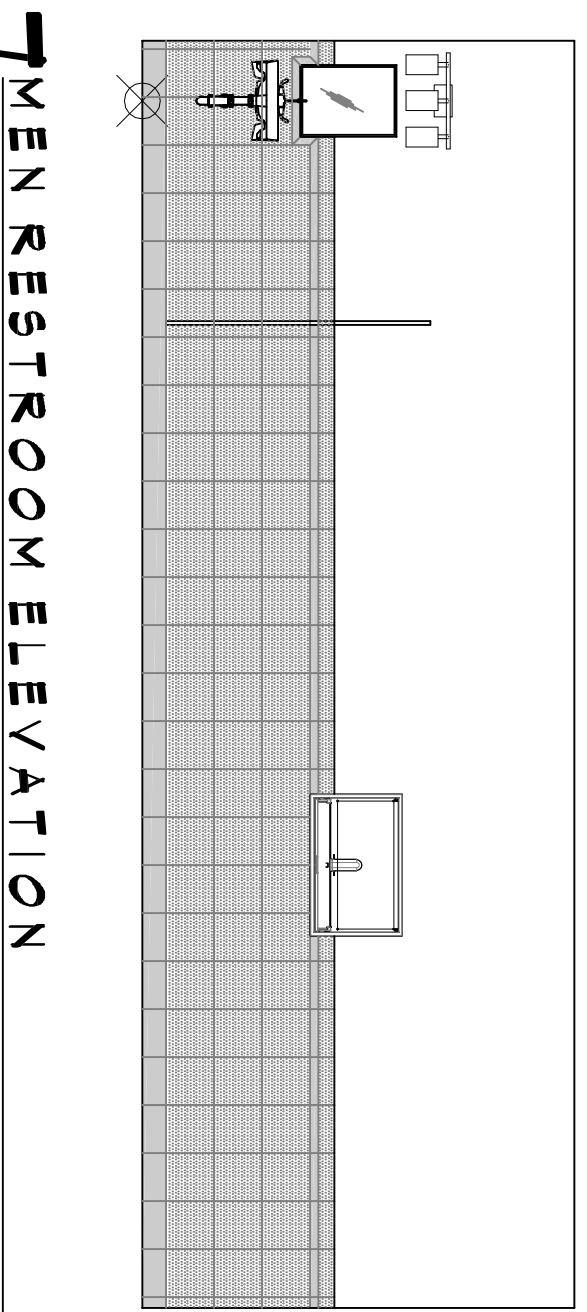

7 MEN RESTROOM ELEVATION
SCALE: 1/4"=1'-0"

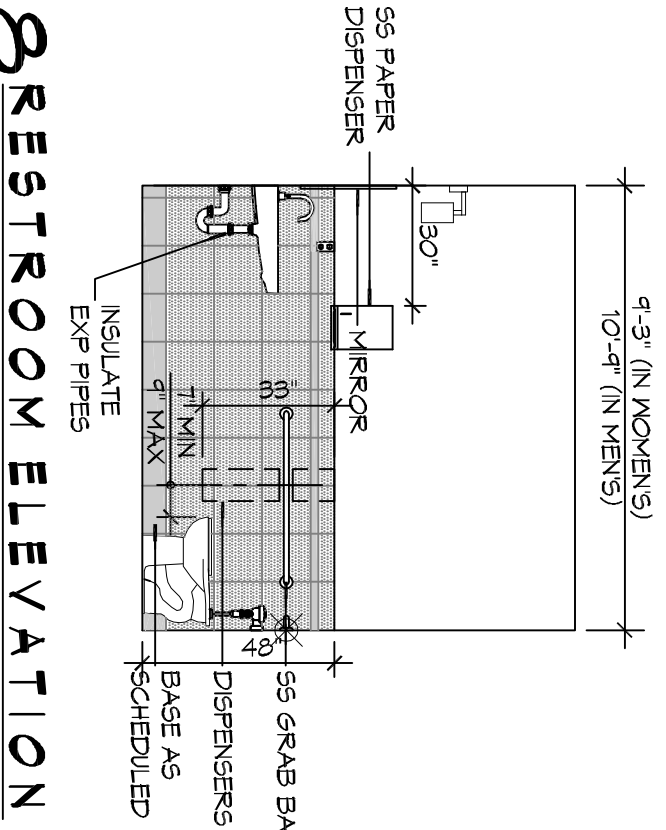

8 RESTROOM ELEVATION
SCALE: 1/4"=1'-0"

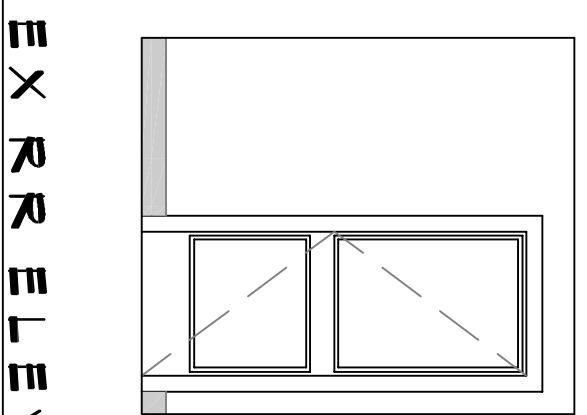

9 UNISEX RR ELEVATION
SCALE: 1/4"=1'-0"

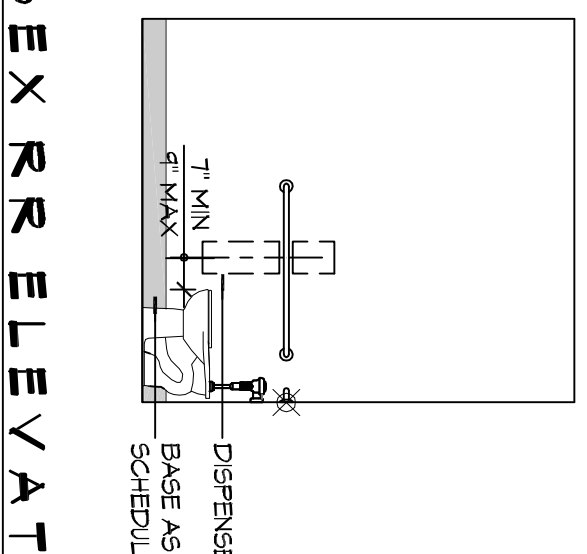

10 UNISEX RR ELEVATION
SCALE: 1/4"=1'-0"

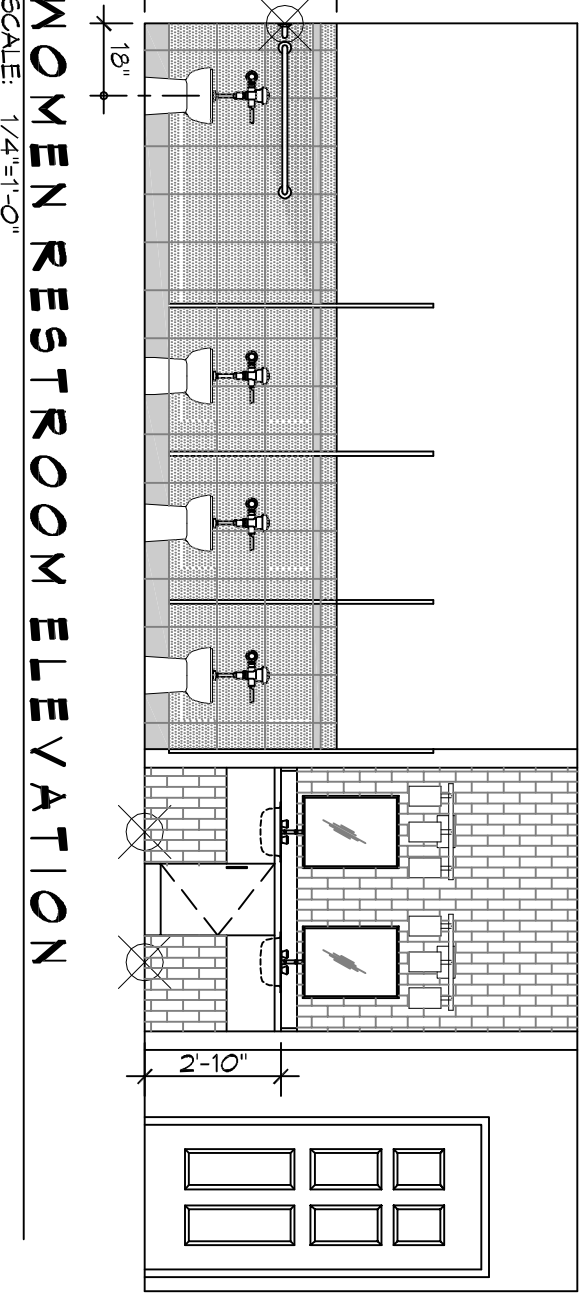

1 WOMEN RESTROOM ELEVATION
SCALE: 1/4"=1'-0"

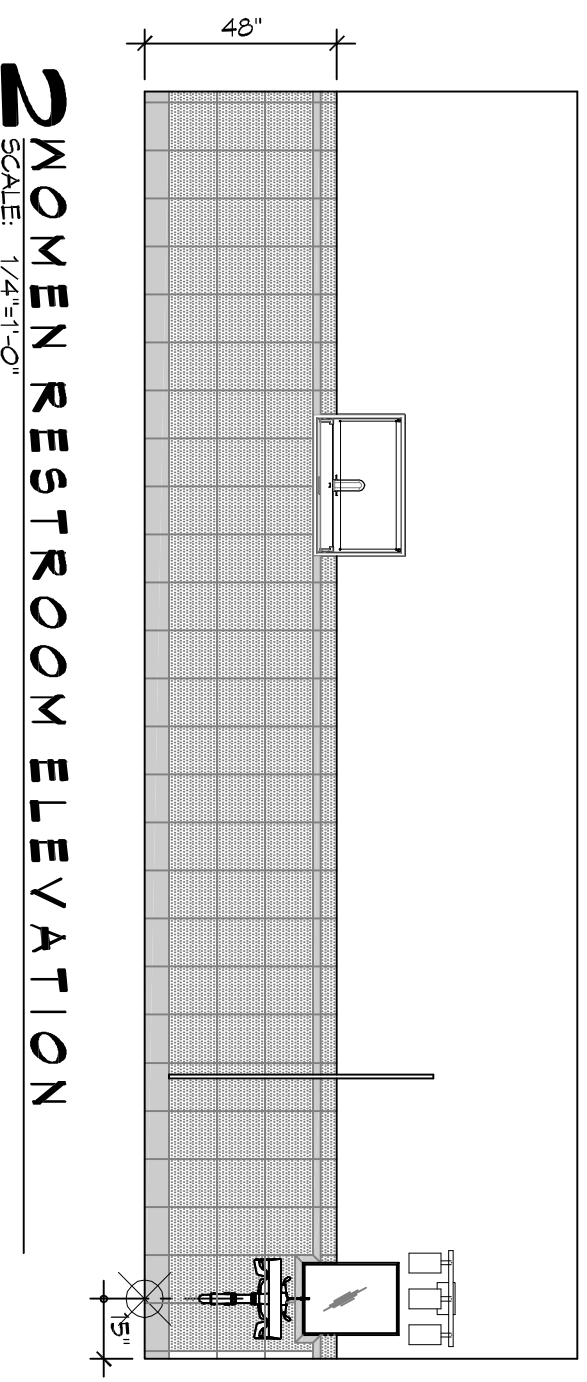

2 WOMEN RESTROOM ELEVATION
SCALE: 1/4"=1'-0"

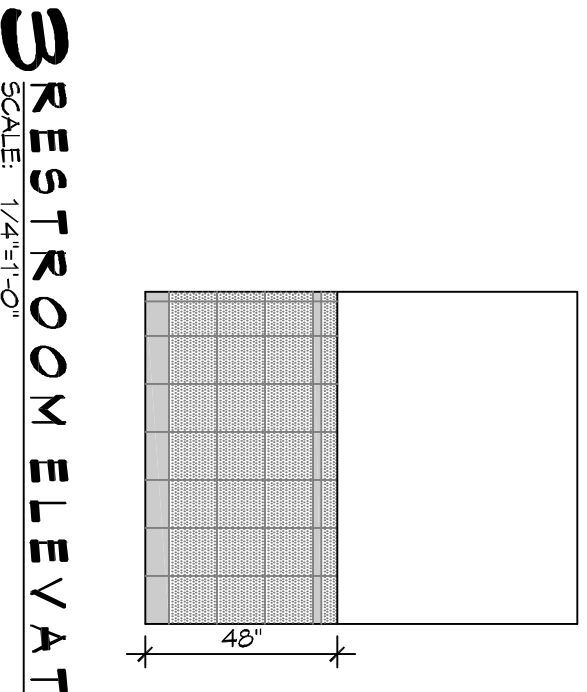

3 RESTROOM ELEVATION
SCALE: 1/4"=1'-0"

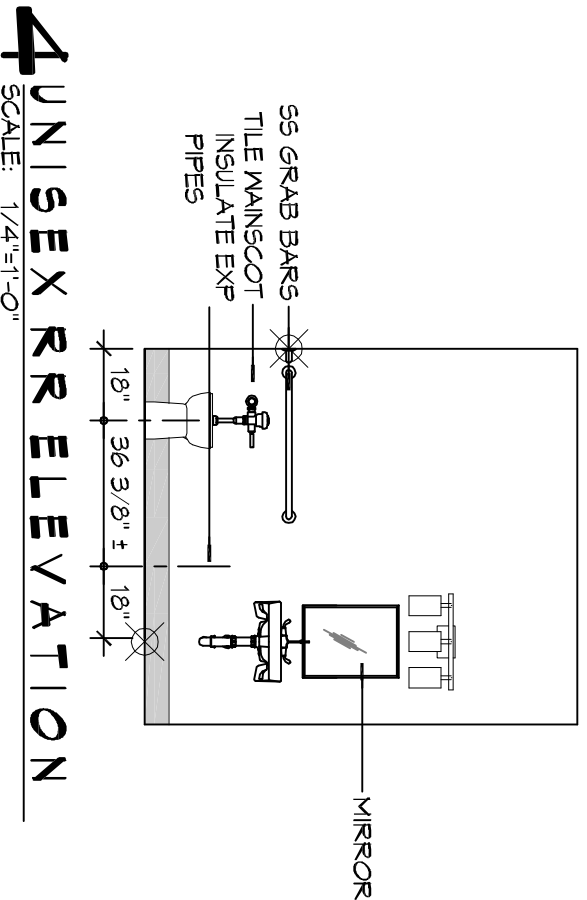

4 UNISEX RR ELEVATION
SCALE: 1/4"=1'-0"

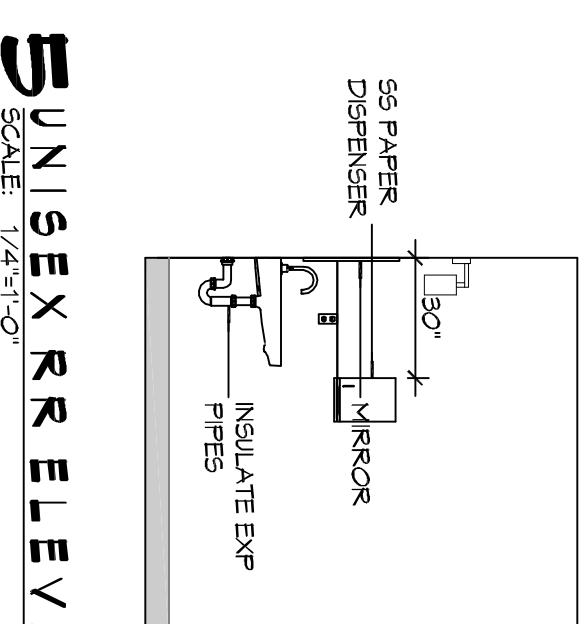

5 UNISEX RR ELEVATION
SCALE: 1/4"=1'-0"

DAMMON ENGINEERING, INC.
LOUISIANA & MISSISSIPPI

Chief Engineer: Brian Mistich, PE
554 Old Spanish Trail
Stidell, LA 70458

www.dammonengineering.com
info@dammonengineering.com
PH: 985.649.5832

NO.	DESCRIPTION	DATE

INTERIOR ELEVATIONS

2091 GAUSE BLYD E
SLIDELL, LA 70461

JOB No: 2360 DATE: 04-19-2016
DRAWN BY: JAVM CHECKED BY: [Signature]