



Precast Concrete
Never Looked So Good!

www.gaineysconcrete.com

December 2, 2016

M. Natal Contractor, Inc.
Attn: Patricia

Re: City of Slidell Sidewalk Improvements

In reference to the above mentioned project, Precast Reinforced Concrete Drainage Structures manufactured by Gainey's Concrete Products, Holden, LA, meet or exceed all reinforcement requirements of the LA DOTD Specifications for Roads and Bridges. The concrete for same structures will have a minimum compressive strength of 5,000 PSI @ 28 days. For reinforcing steel detail, please refer to Gainey's Concrete Products Typical Catch Basin Specification Sheet. In addition, joints for same structures meet or exceed all requirements for flexible plastic gaskets and Louisiana DOTD specifications.

If you have any questions or need assistance, please don't hesitate to contact me.

Sincerely,

Brandon Frierson

Brandon Frierson
Gainey's Concrete Products, Inc.

DAMMON ENGINEERING INC

Date: 12-5-16 Project: CITY OF SLIDELL SIDEWALKS
Reviewed: _____
Reviewed as Noted: _____
Revise and Resubmit: _____
Rejected: _____
Other: _____

Enc:
Gainey's Concrete Typical Catch Basin Details
Shop Drawings
4618 Frame Casting Specifications
6258 Cover Casting Specifications
Ram-Nek Joint Sealant Data Sheet

Corrections or comments made on the shop drawings during this review do not relieve the contractor from compliance with requirements of the drawings and specifications. This check is only for review of the general conformance with the design concept of the project and general compliance with the information given in the contract documents. This contractor is responsible for confirming and correlating all quantities and dimensions, selecting fabrication processes and techniques of construction, coordinating his or her work with that at all other trades and performing all in a safe and satisfactory manner.

Submittal Item: DROP INLETS
Comments

PRECAST DRAIN UNITS	
SIZES (ID)	1.5' X 1.5' 2' X 2.5' 2' X 3' 3' X 3' 4' X 2' 4' X 3' 4' X 4'
MAX HT	AS <input checked="" type="checkbox"/>
FEET	in ² /ft.
	8 0.20

- NOTES:
1. AREA STEEL CALCULATED WITH ENGINEERED MAT & REBAR DESIGNED TO MEET REQUIRED AREA OF STEEL. ALL GRADE 60 MINIMUM.
 2. AREA OF STEEL APPLIES TO BOTH DIRECTIONS & AT ALL LOCATIONS.
 3. CLASS 1 CONCRETE WITH DESIGN STRENGTH OF 4500 PSI AT 28 DAYS.
 4. PIPE TO BE GROUTED IN BY CONTRACTOR AFTER INSTALLATION.

APPROVED FOR PRODUCTION: _____
 APPROVED FOR PRODUCTION
 W/ CHANGES: _____
 RESUBMITTAL REQUIRED: _____

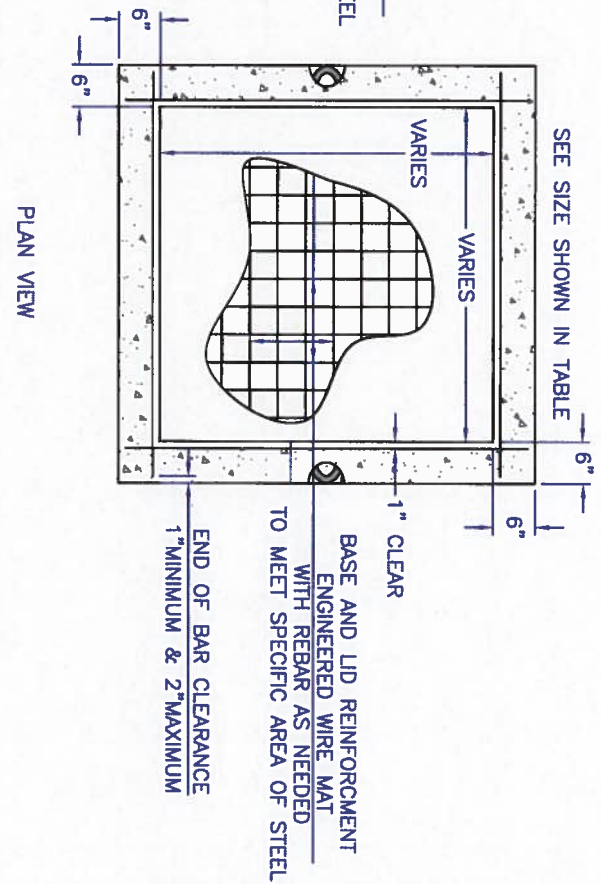
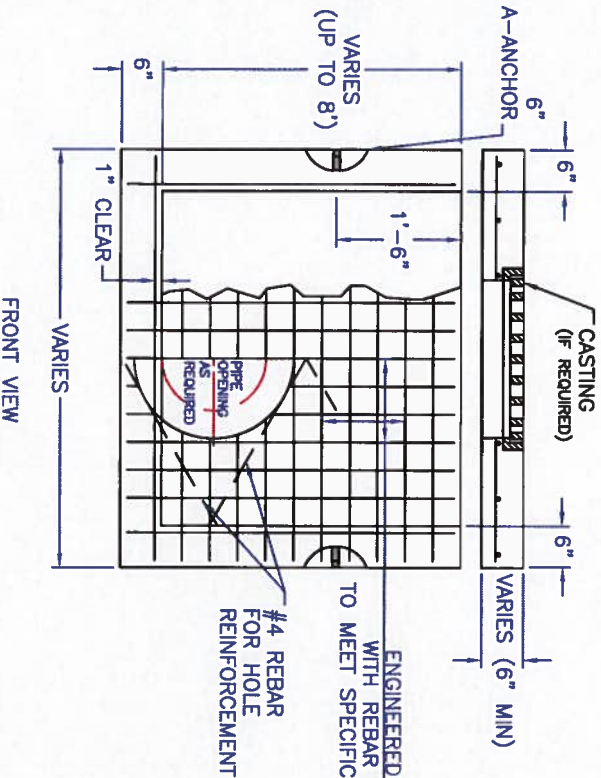

gaineys
CONCRETE PRODUCTS



28021 Colket-Vail Road
 Phone (225) 567 - 2700

Holden, LA
 Fax (225) 567 - 3089

www.gaineyconcrete.com

TYPICAL CATCH BASIN DETAIL

SCALE: NOT TO SCALE

DATE: 9/14/12

DRAWN BY: DC

CHECKED BY: CG

Structure Product Detail

Item	Product	Qty	Product Description	Yards	Weight
Top 3	FT3X3	1	Flat Top 36" x 36" w/ 4618	0.19	755
Base	CB2X2-6	1	CB2X2-6 BASE x 32"	0.53	2,136
	1 1/4 TS	1	1 1/4" Tarseal	0.00	0
	USF 461	1	USF 4618 Frame (24" x 24")	0.00	0
	USF 625	1	USF 6258 Grate (24" x 24")	0.00	0
Structure Totals				0.72	2,891

Elevations

Rim	Elev	Angle	Pipe	Hole Type	Hole" Height	Hole" Width	Up"	Item
(1)	0	90	15 RCP	HOLE	24	24	0	Base
(2)	0	270	15 RCP	HOLE	24	24	0	Base
(3)	0	0			0	0	0	
(4)	0	0			0	0	0	
(5)	0	0			0	0	0	
(6)	0	0			0	0	0	
(7)	0	0			0	0	0	
(8)	0	0			0	0	0	

Description: CB2X2-6 BASE x 32"
 Product ID: CB2X2-6B
 Item: Base
 Step Location:

Inside Area View	Wall	Summp
Rim to Invert	3.00'	7.00"
Less Casting	3.00'	
Invert to Floor	0.19'	
Adjustment (Brick/Mort.)	0.02	
Pre-cast Height	3.17'	
Floor	6.00"	
Plus Floor	3.67'	

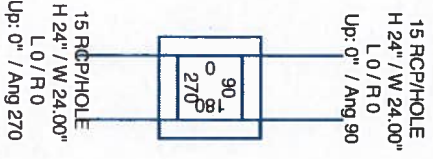
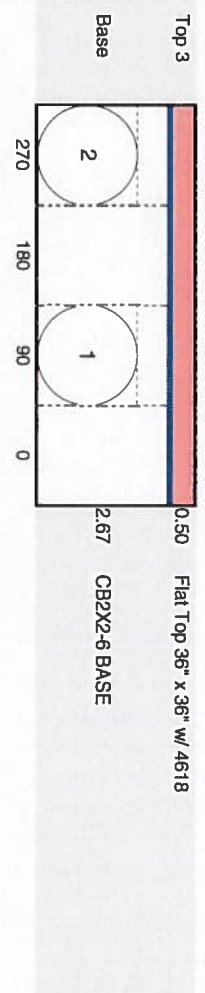

----- Side 24.0" -----

----- Side 24.0" -----

Structure Product Detail

Item	Product	Qty	Product Description	Yards	Weight
Top 3	FT3X3	1	Flat Top 36" x 36" w/ 4618	0.19	755
Base	CB2X2-6	1	CB2X2-6 BASE x 32"	0.53	2,136
	1 1/4 TS	1	1 1/4" Tarseal	0.00	0
	USF 461	1	USF 4618 Frame (24" x 24")	0.00	0
	USF 625	1	USF 6258 Grate (24" x 24")	0.00	0
Structure Totals				0.72	2,891

Elevations

Rim	Elev	Angle	Pipe	Hole Type	Hole Height	Hole Width	Up"	Item
(1)	0	90	15 RCP	HOLE	24	24	0	Base
(2)	0	270	15 RCP	HOLE	24	24	0	Base
(3)								
(4)								
(5)								
(6)								
(7)								
(8)								

Description: CB2X2-6 BASE x 32"
 Product ID: CB2X2-6B
 Item: Base Step Location:

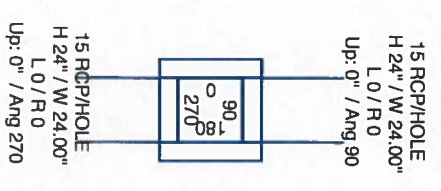

Inside Area View	Wall	Sump
Rim to Invert	3.00'	7.00"
Less Casting	3.00'	
Invert to Floor	0.19'	
Adjustment (Block/Mort.)	0.02	
Precast Height	3.17'	
Floor	6.00"	
Plus Floor	3.67'	

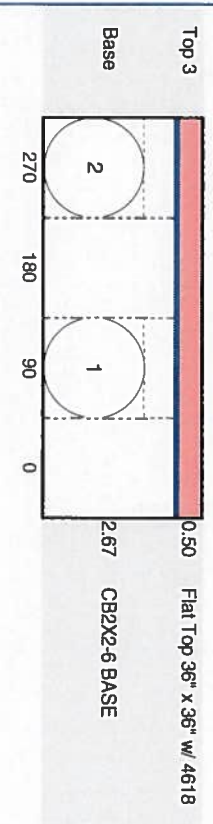

----- Side 24.0" -----

----- Side 24.0" -----

Structure Product Detail

Item	Product	Qty	Product Description	Yards	Weight
Top 3	FT4X3	1	Flat Top 4' x 3' w/ 4618	0.22	900
Base	CB2X3B	1	CB2X3 BASE x 33"	0.81	3,229
	1 1/4 TS	1	1 1/4" Tarsenal	0.00	0
	USF 461	1	USF 4618 Frame (24" x 24")	0.00	0
	USF 625	1	USF 6258 Grate (24" x 24")	0.00	0
Structure Totals				1.03	4,129

Elevations

Rim	Elev	Angle	Pipe	Hole Type	Hole Height	Hole Width	Up"	Item
(1)	0	270	15 RCPA	Hole	19	26	0	Base
(2)	0	0			0	0	0	
(3)	0	0			0	0	0	
(4)	0	0			0	0	0	
(5)	0	0			0	0	0	
(6)	0	0			0	0	0	
(7)	0	0			0	0	0	
(8)	0	0			0	0	0	

Description: CB2X3 BASE x 33"
 Product ID: CB2X3B
 Item: Base Step Location:

Rim to Invert 3.00'
 Less Casting 3.00'
 Invert to Floor 0.25'
 Adjustment (Brick/Mort.) 0.00'

Inside Area View
 Precast Height 3.25'
 Floor 6.00"
 Plus Floor 3.75'

Wall 6.00"
 Sump 0.00'

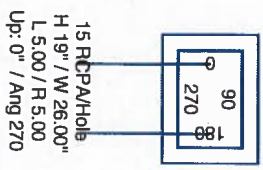
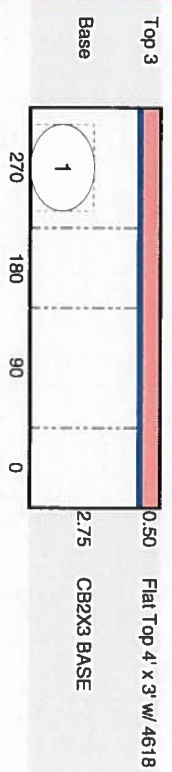

----- Side 24.0" -----

----- Side 36.0" -----

Structure Product Detail

Item	Product	Qty	Product Description	Yards	Weight
Top 3	FT4X3	1	Flat Top 4' x 3' w/ 4618	0.22	900
Base	CB2X3B	1	CB2X3 BASE x 33"	0.77	3,083
	1 1/4 TS	1	1 1/4" Tarseal	0.00	0
	USF 461	1	USF 4618 Frame (24" x 24")	0.00	0
	USF 625	1	USF 6258 Grate (24" x 24")	0.00	0
Structure Totals				0.99	3,983

Elevations

Rim	Elev	Angle	Pipe	Hole Type	Hole Height	Hole Width	Up"	Item
(1)	0	270	15 RCPA	Hole	19	26	0	Base
(2)	0	90	15 RCPA	Hole	19	26	0	Base
(3)	0	0			0	0	0	
(4)	0	0			0	0	0	
(5)	0	0			0	0	0	
(6)	0	0			0	0	0	
(7)	0	0			0	0	0	
(8)	0	0			0	0	0	

Description: CB2X3 BASE x 33"
 Product ID: CB2X3B
 Item: Base Step Location:

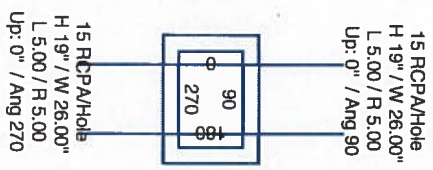

----- Side 24.0" -----

----- Side 36.0" -----

Inside Area View

	Top 3	Base	
Rim to Invert	3.00'		
Less Casting	3.00'		
Invert to Floor	0.25'		
Adjustment (Brick/Mort.)	0.00		
Precast Height	3.25'		
Floor	6.00"		
Plus Floor	3.75'		
Wall	6.00"		
Sump	0.00'		

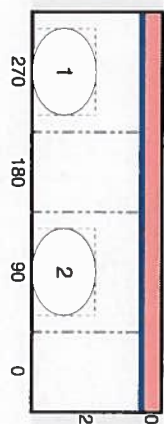

Structure Product Detail

Item	Product	Qty	Product Description	Yards	Weight
Top 3	FT4X3	1	Flat Top 4' x 3' w/ 4618	0.22	900
Base	CB2X3B	1	CB2X3 BASE x 33"	0.77	3,098
	1 1/4 TS	1	1 1/4" Tarselal	0.00	0
	USF 461	1	USF 4618 Frame (24" x 24")	0.00	0
	USF 625	1	USF 6258 Gate (24" x 24")	0.00	0
Structure Totals				0.99	3,998

Elevations

Rim	Elev	Angle	Pipe	HOLE Type	HOLE Height	HOLE Width	Up"	Item
(1)	0	270	12 RCP	HOLE	18	18	1	Base
(2)	0	90	15 RCPA	Hole	19	26	0	Base
(3)	0	0			0	0	0	
(4)	0	0			0	0	0	
(5)	0	0			0	0	0	
(6)	0	0			0	0	0	
(7)	0	0			0	0	0	
(8)	0	0			0	0	0	

Description: **CB2X3 BASE x 33"**
 Product ID: **CB2X3B**
 Item: **Base** Step Location:

Up to Bottom	Inside Area View	Wall Sump
Rim to Invert	3.00'	3.25'
Less Casting	3.00'	6.00"
Invert to Floor	0.25'	
Adjustment (Brick/Mort.)	0.00	3.75'
		Plus Floor

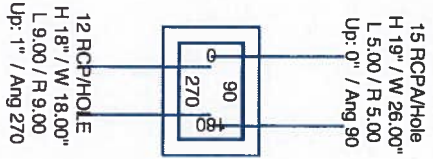
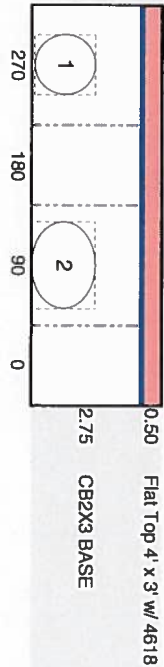

----- Side 24.0" -----
 ----- Side 36.0" -----

Structure Product Detail

Item	Product	Qty	Product Description	Yards	Weight
Top 3	FT4X3	1	Flat Top 4' x 3' w/ 4618	0.22	900
Base	CB2X3B	1	CB2X3 BASE x 33"	0.77	3,098
	1 1/4 TS	1	1 1/4" Tarseal	0.00	0
	USF 461	1	USF 4618 Frame (24" x 24")	0.00	0
	USF 625	1	USF 6258 Grate (24" x 24")	0.00	0
Structure Totals				0.99	3,998

Elevations

Rim	Elev	Angle	Pipe	Hole Type	Hole Height	Hole Width	Up"	Item
(1)	0	270	15 RCPA	HOLE	19	26	0	Base
(2)	0	90	12 RCP	HOLE	18	18	1	Base
(3)	0	0			0	0	0	
(4)	0	0			0	0	0	
(5)	0	0			0	0	0	
(6)	0	0			0	0	0	
(7)	0	0			0	0	0	
(8)	0	0			0	0	0	

Description: **CB2X3 BASE x 33"**
 Product ID: **CB2X3B**
 Item: **Base** Step Location:

	Inside Area View	Wall
Rim to Invert	3.00'	6.00"
Less Casting	3.00'	
Invert to Floor	0.25'	
Adjustment (Brick/Mort.)	0.00	
		Summp
		0.00'

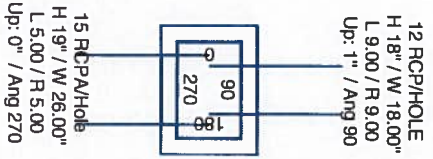
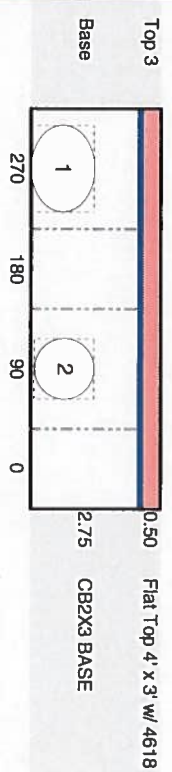

----- Side 36.0" -----

----- Side 24.0" -----

Structure Product Detail

Item	Product	Qty	Product Description	Yards	Weight
Top 3	FT4X3	1	Flat Top 4' x 3' w/ 4618	0.22	900
Base	CB2X3B	1	CB2X3 BASE x 33"	0.77	3,098
	1 1/4 TS	1	1 1/4" Tarseal	0.00	0
	USF 461	1	USF 4618 Frame (24" x 24")	0.00	0
	USF 625	1	USF 6258 Grate (24" x 24")	0.00	0
Structure Totals				0.99	3,998

Elevations

Rim	Elev	Angle	Pipe	Hole Type	Hole Height	Hole Width	Up"	Item
(1)	0	270	15 RCPA	HOLE	19	26	0	Base
(2)	0	90	12 RCP	HOLE	18	18	1	Base
(3)	0	0			0	0	0	
(4)	0	0			0	0	0	
(5)	0	0			0	0	0	
(6)	0	0			0	0	0	
(7)	0	0			0	0	0	
(8)	0	0			0	0	0	

Description: CB2X3 BASE x 33"
 Product ID: CB2X3B
 Item: Base Step Location:

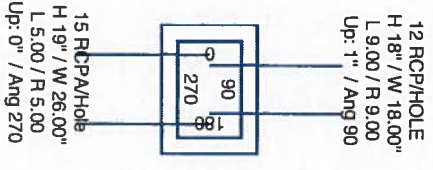

----- Side 24.0" -----

Rim to Invert 3.00'
 Less Casting 3.00'
 Invert to Floor 0.25'
 Adjustment (Brick/Mort.) 0.00'

Inside Area View
 Precast Height 3.25'
 Floor 6.00"
 Plus Floor 3.75'

Wall 6.00"
 Sump 0.00'

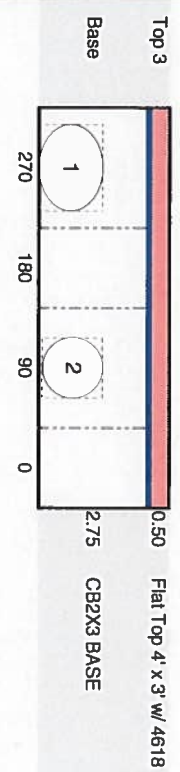

----- Side 36.0" -----

Structure Product Detail

Item	Product	Qty	Product Description	Yards	Weight
Top 3	FT4X3	1	Flat Top 4' x 3' w/ 4618	0.22	900
Base	CB2X3B	1	CB2X3 BASE x 33"	0.77	3,083
	1 1/4 TS	1	1 1/4" Tarseal	0.00	0
	USF 461	1	USF 4618 Frame (24" x 24")	0.00	0
	USF 625	1	USF 6258 Grate (24" x 24")	0.00	0
Structure Totals				0.99	3,983

Inside Area View	Wall
Rim to Invert	6.00 "
Less Casting	0.00 '
Invert to Floor	3.75 '
Adjustment (Brick/Mort.)	0.00
Precast Height	3.25 '
Floor	6.00 "
Plus Floor	3.75 '
Summp	0.00 '

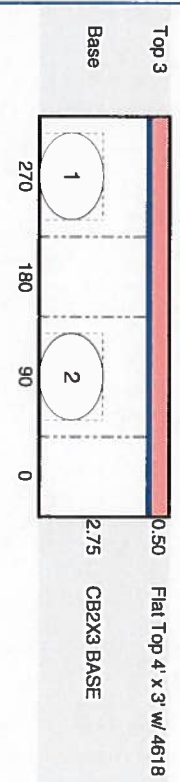

Elevations

Rim	Elev	Angle	Pipe	Hole Type	Hole Height	Hole Width	Up"	Item
(1)	0	270	15 RCPA	Hole	19	26	0	Base
(2)	0	90	15 RCPA	Hole	19	26	0	Base
(3)	0	0			0	0	0	
(4)	0	0			0	0	0	
(5)	0	0			0	0	0	
(6)	0	0			0	0	0	
(7)	0	0			0	0	0	
(8)	0	0			0	0	0	

Description: CB2X3 BASE x 33"
 Product ID: CB2X3B
 Item: Base Step Location:

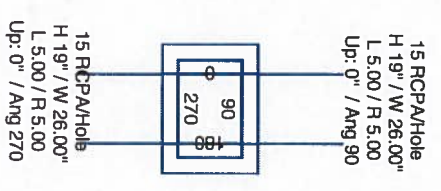

----- Side 24.0" -----

----- Side 36.0" -----

Structure Product Detail

Item	Product	Qty	Product Description	Yards	Weight
Top 3	FT4X3	1	Flat Top 4' x 3' w/ 4618	0.22	900
Base	CB2X3B	1	CB2X3 BASE x 33"	0.77	3,098
	1 1/4 TS	1	1 1/4" Tarseal	0.00	0
	USF 461	1	USF 4618 Frame (24" x 24")	0.00	0
	USF 625	1	USF 6258 Grate (24" x 24")	0.00	0
Structure Totals				0.99	3,998

Rim	Elev	Angle	Pipe	Elevations		Hole" Height	Hole" Width	Up"	Item
				Hole Type	Hole				
(1)	0	270	12 RCP	HOLE	18	18	1	Base	
(2)	0	90	15 RCPA	Hole	19	26	0	Base	
(3)	0	0			0	0	0		
(4)	0	0			0	0	0		
(5)	0	0			0	0	0		
(6)	0	0			0	0	0		
(7)	0	0			0	0	0		
(8)	0	0			0	0	0		

Description: **CB2X3 BASE x 33"**
 Product ID: **CB2X3B**
 Item: **Base** Step Location:

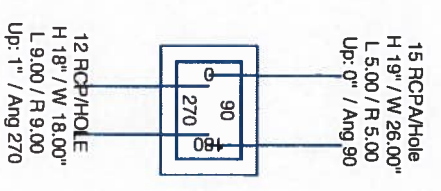

----- Side 24.0" -----

----- Side 36.0" -----

Inside Area View		Wall
Rim to Invert	3.00'	6.00"
Less Casting	3.00'	
Invert to Floor	0.25'	
Adjustment (Brick/Mort.)	0.00	
Top 3	0.50'	6.00"
Base	2.75'	6.00"

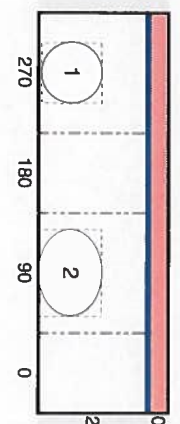

Structure Product Detail

Item	Product	Qty	Product Description	Yards	Weight
Top 3	FT4X3	1	Flat Top 4' x 3' w/ 4618	0.22	900
Base	CB2X3B	1	CB2X3 BASE x 33"	0.77	3,098
	1 1/4 TS	1	1 1/4" Tar Seal	0.00	0
	USF 461	1	USF 4618 Frame (24" x 24")	0.00	0
	USF 625	1	USF 6258 Grate (24" x 24")	0.00	0
Structure Totals				0.99	3,998

Item	Product Description	Yards	Weight
Rim to Invert		3.00'	
Less Casting		3.00'	
Invert to Floor		0.25'	
Adjustment (Block/Mort.)		0.00	
Inside Area View			
Precast Height		3.25'	
Floor		6.00"	
Plus Floor		3.75'	
Wall		6.00"	
Summp		0.00'	

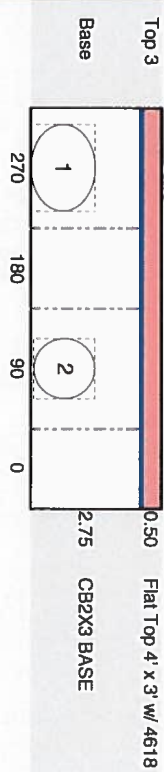

Elevations

Rim	Elev	Angle	Pipe	Hole Type	Hole Height	Hole Width	Up"	Item
(1)	0	270	15 RCPA	HOLE	19	26	0	Base
(2)	0	90	12 RCP	HOLE	18	18	1	Base
(3)	0	0			0	0	0	
(4)	0	0			0	0	0	
(5)	0	0			0	0	0	
(6)	0	0			0	0	0	
(7)	0	0			0	0	0	
(8)	0	0			0	0	0	

Description: **CB2X3 BASE x 33"**
 Product ID: **CB2X3B**
 Item: **Base** Step Location:

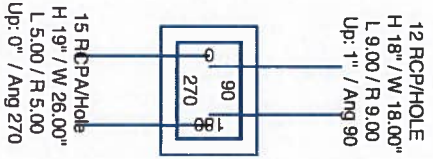

----- Side 24.0" -----

----- Side 36.0" -----

Structure Product Detail

Item	Product	Qty	Product Description	Yards	Weight
Top 3	FT4X3	1	Flat Top 4' x 3' w/ 4618	0.22	900
Base	CB2X3B	1	CB2X3 BASE x 33"	0.77	3,098
	1 1/4 TS	1	1 1/4" Tarseal	0.00	0
	USF 461	1	USF 4618 Frame (24" x 24")	0.00	0
	USF 625	1	USF 6258 Grate (24" x 24")	0.00	0
Structure Totals				0.99	3,998

Elevations

Rim	Elev	Angle	Pipe	HOLE Type	Hole" Height	Hole" Width	Up"	Item
(1)	0	270	12 RCP	HOLE	18	18	1	Base
(2)	0	90	15 RCPA	Hole	19	26	0	Base
(3)	0	0			0	0	0	
(4)	0	0			0	0	0	
(5)	0	0			0	0	0	
(6)	0	0			0	0	0	
(7)	0	0			0	0	0	
(8)	0	0			0	0	0	

Description: **CB2X3 BASE x 33"**
 Product ID: **CB2X3B**
 Item: **Base** Step Location:

	Inside Area View	Wall
Rim to Invert	3.00'	6.00"
Less Casting	3.00'	
Invert to Floor	0.25'	
Adjustment (Brick/Mort.)	0.00	
		Sump
		6.00"

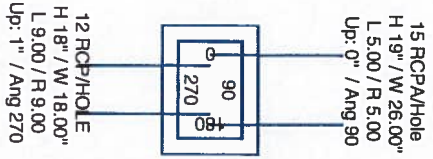
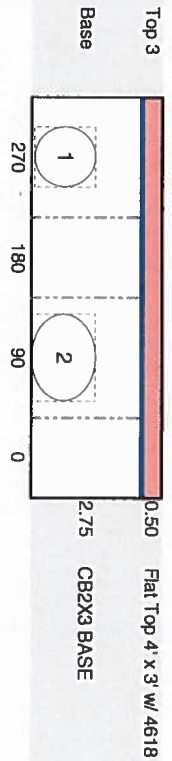

----- Side 24.0" -----
 ----- Side 36.0" -----

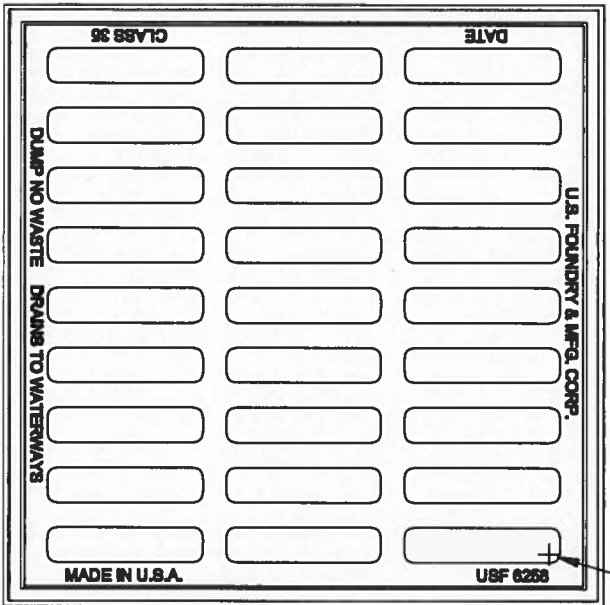

R3/8 TYP.

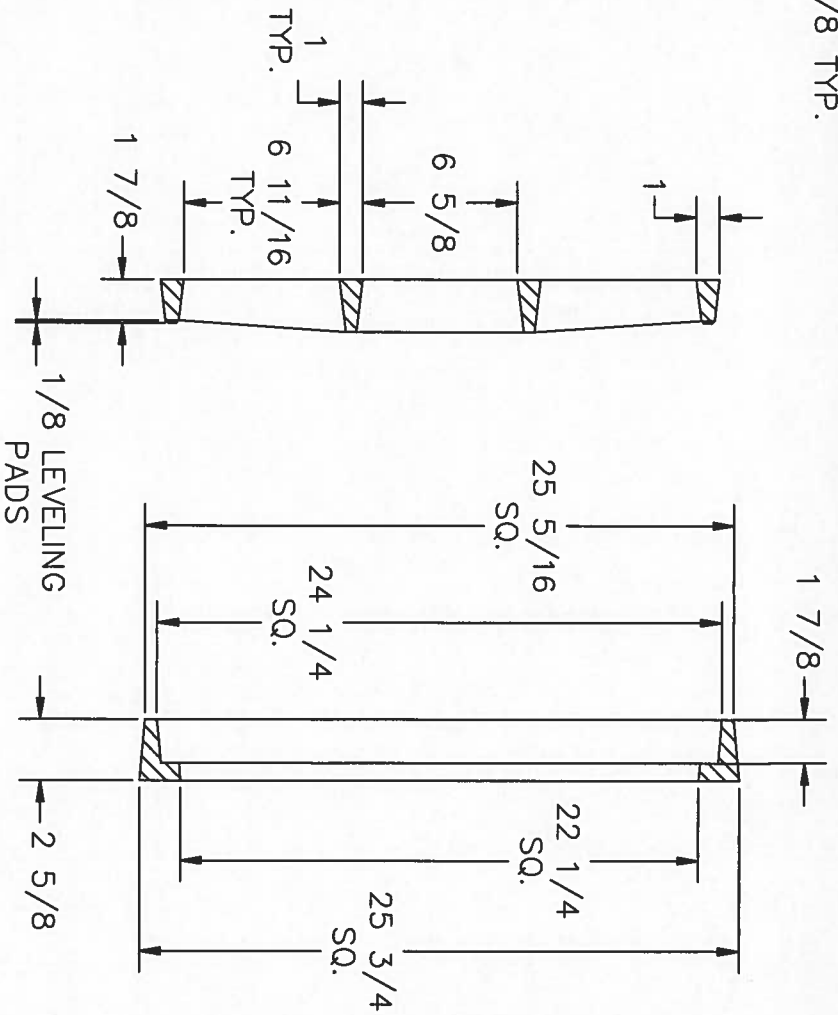
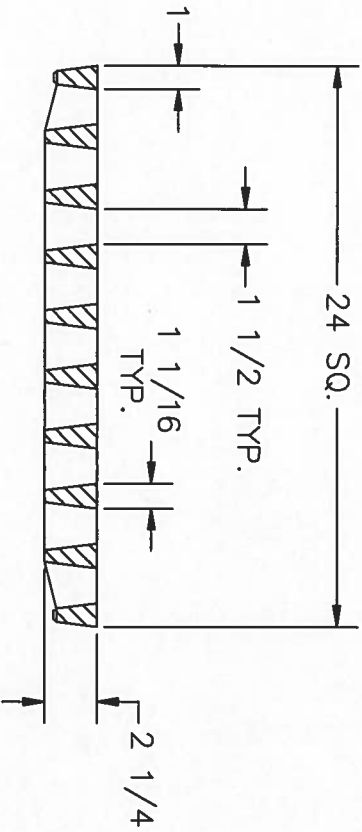

US FOUNDRY & MFG. CORP.
 8351 NW 93rd Street, Moultrie, FL 33166-2025
 ph: 1-800-432-9709; fax: 305-887-9429
 www.usfoundry.com
 © 2013 US Foundry & Mfg. Corp. All Rights Reserved

USF 4618 Frame & 6258 Grate

LOAD CLASSIFICATION:	Heavy Duty
MATERIAL:	ASTM-A48 GRAY IRON CLASS35B
Ring No:	8030056
Cover No:	8070546
DATE:	08-08-07
Assembly No:	8040232
SCALE:	1/8"=1"
DATE:	08-08-07
PRNT BY:	ULS
REV:	1
DATE:	11-14-07
REV BY:	HJF
QUOTE#	2023

Physical Properties

Appearance Semi-solid	Maximum VOC <5 g/l	Softening Point (ASTM D 36) 320°F
Ductility @ 77° F, 5cm/min (ASTM D113) Min. 5.0	Penetration @ 77°F (150g 5 sec) (ASTM D217) Min. 50 - Max. 120	Specific Gravity @ 77° F (25°C) (ASTM D71) Min. 1.20 - Max. 1.35
Flash Point, C.O.C. (ASTM D92) Min. 600°F		

Approvals and Certifications

Meets or exceeds all requirements of **ASTM C990 Standard Specification** for joints, concrete pipe, manholes and precast box sections, using Preformed Flexible Joint Sealants.

Meets requirements of **Federal Specifications SS-S210-A**, "Sealing Compound Preformed Plastic For Pipe Joints", Type 1, Rope Form.

Usage

Flexible Plastic Gaskets for sealing the following Precast products, regardless of size or shape:

- Storm Sewer Pipe
- Box Culverts
- Manhole Risers
- Septic Tanks
- Utility & Burial Vaults
- Wet Wells

Application

Vertical Application:

1. Apply one brush coat of **Ram-Nek Primer** to concrete surfaces to be sealed. Primer is recommended but not required unless conditions are wet.
2. Remove protective wrapper on one side only of preformed **Ram-Nek** coil and press firmly to the dry, clean joint surface. Leave the outside wrapper in place to protect the gasket and keep it from stretching.
3. Remove protective wrapper from **Ram-Nek** gasket and set next section. Each unit is forced "home" by its own weight, compressing **Ram-Nek** to tightly pack and immediately seal the joint. "Squeeze out" is visible proof of a watertight joint.
4. After last section is set and fully "seated", the installation is complete. Backfilling and compaction can start immediately.

Horizontal Application:

1. Trench conditions shall be such that pipe jointing can be accomplished without getting mud, silt, gravel or other foreign materials into the joint. Generally, the trench should be dewatered and have a firm bottom free of muck.
2. Remove protective wrapper on one side only of preformed **Ram-Nek** coil and press firmly to the dry, clean joint surface. Before laying the pipe in the trench, attach the gaskets end-to-end to the leading edge of the tongue or groove of each pipe joint, forming a continuous gasket around the circumference. Remove the protective wrapper before joining pipe sections.
3. After the gasket is applied, the pipe should be handled carefully to avoid displacing or soiling of gasket. Any gasket so disturbed should be replaced.
4. The pipe should be properly aligned before joints are forced home. For tongue and groove pipe, the pipe should be partially

supported to maintain concentricity until the gasket is properly compressed in the joint space and sufficient pressure applied to make sure that the joint is properly made.

5. Backfilling and compaction can begin when jointing is completed.

Product Sizes

9 (.75in x 14.5ft) COILS/CASE
5 (1.25in x 14.5ft) COILS/CASE

8 (1in x 14.5ft) COILS/CASE (46.8

5 (1.5in x 10.5ft) COILS/CASE (49