



Medical Air Solutions, LLC

Marietta, GA 30068, 800-645-1059, Fax 770-977-9964

Technology & Service

Proposal: P-01-24-10-R1

Title: CSP Area Upgrade to Comply with USP 797

Slidell Memorial Hospital
1001 Gause Blvd.

Client: Slidell, LA 70458

Curtis Hebert, Pharm D, Dir. of Pharmacy
Ben Galloway, PE, Facility Services. Director
Chuck Dammon, Dammon Engineering

Proposal Date: March 22, 2010

Revised: May 31, 2010

Author: Judi Bowman, Project Coordinator

Company: Medical Air Solutions, LLC

Address: 3080 Brookview Drive

Marietta GA 30068-3813

Corporate (800) 645-1059 (Toll Free)

Facsimile: (770) 977-9964

Engineering: (770) 377-3884

Copyright and Fee Notice

The document text and drawings contained herein are provided at no cost and are intended for use by, and dissemination to, hospital personnel only. This copyrighted © document and line drawings are the property of Medical Air Solutions, LLC (MAS) and are not to be disseminated to architects, engineers, contractors or others not employed or contracted by the hospital without express written permission of MAS. Should this document and design be utilized for construction of and/or renovation to the areas depicted in this document without purchasing MAS equipment then a document fee of \$2500.00 shall be assessed immediately upon that decision. Please remit to Medical Air Solutions, LLC, 3080 Brookview Drive, Marietta GA 30068-3813. Call 800-645-1059 if there are any questions.

Proposal P-01-24-10=R1

Title: CSP Area Upgrade to Comply with USP 797

1.0 Scope

- 1.1 Design renovation for the Compounding of Sterile Preparations (CSP) area. **Buffer Zone 1** and the **Anteroom** shall be positive pressure environments with **Buffer Zone 2** a negative pressure environment. They shall meet or exceed the standards for an ISO Class 7 (Class 10,000) or ISO Class 8 (Class 100,000) cleanrooms stated by the **United States Pharmacopeia General Chapter <797>** issued December 3, 2007.
 - 1.1.1 It is noted that the compounding of some radioactive and other medications (i.e., Chemotherapy) should be performed in a negative pressure atmosphere (e.g., those that can cause abortion, allergy, birth defects, blisters, burns, cancer, cytotoxicity, genetic damage, infertility, irritation, sensitivity, vital organ toxicity, or other adverse effects). Check applicable state and federal guidelines and standards, and NIOSH Publication No. 2004-165 at www.cdc.gov/niosh/docs/2004-165/ for safe practices.
- 1.2 This proposal contains a quote for Air Purification Systems (APS) and their control equipment plus any switches, monitors, UVGI devices, HVAC air supply diffusers and exhaust grilles, particle counter, prefabricated walls and ceilings and other items that may be required. The quote shall be for equipment, instruments and some materials of construction. Final CAD drawings will be generated by the architectural and engineering (A&E) group, **Dammon Engineering** in Slidell, LA. ***This proposal includes shipping and installation pricing for ONLY the equipment and materials listed in this document*** and will be included as part of the turnkey cost to be determined by **New & Associates, Inc.**
- 1.3 The recommendations for renovation are listed herein. Renovation may be performed by **American Medical Systems, LLC. (AMS)**, a **MAS** preferred contractor. An installation estimate from **American Medical Systems** will be provided under separate cover.

2.0 Safety

- 2.1 This area shall be renovated to ensure that any pathogens, spores or other foreign substances are excluded from the room by the maintenance of HEPA filtered air changes and positive pressure.
- 2.2 All building materials and actual construction/renovation shall comply with all applicable building codes and standards. All electrical and electronic components shall have Underwriters Laboratories (UL) and/or Canadian Standards Association (CSA) approval.
- 2.3 Renovation of the room and installation of the equipment shall comply with all state and local building codes and may need to be reviewed by state or local boards of health or other government agencies. This renovation may require licenses or permits which shall be the responsibility of **Slidell Memorial Hospital** or the designated contractor. That decision shall be made between the pharmacy and the contractor.
- 2.4 The recommendations for renovation/upgrade of a Compounding of Sterile Preparations (CSP) positive pressure area are taken from various authoritative sources such as:
 - United States Pharmacopeia (USP/MAS – Direct dialog with **USP <797>** committee)
 - Centers for Disease Control and Prevention (CDC)
 - United States Occupational Health and Safety Administration (OSHA)
 - National Institutes for Occupational Safety and Health (NIOSH)
 - American Institute of Architects (AIA)

3.0 Drawing P-01-24-10-1-1

CSP Area – Current CSP Area Layout

- 3.1 The current layout of this area is depicted on this **Drawing P-01-24-10-1-1** from a DWG drawing from the facility engineer. Note that the APS system used for this upgrade will be **medical-grade™*** and will comply with federal and state **“Green”** initiatives.
- 3.2 Currently, the **Compounding of Sterile Preparations Area** (CSP Area) is within the **Common Pharmacy Area**. The proposed area currently comprises three (3) patient rooms (Room 107, Room 108 and Room 109)
- 3.3 **LAFW unit #1** will be purchased new and located in **Buffer Zone 1** to perform low and medium risk CSP.
- 3.4 **Hood Unit #1** will be purchased new and located in **Buffer Zone 2** to perform chemo CSP. The hood unit exhausts air to the outside (rooftop) to a single dedicated duct that vents to **OE1**. The hood being purchased should have the capability to exhaust 800 CFM.
- 3.5 The proposed pharmacy **CSP Area** is on the first floor of one floor.
- 3.6 The flooring in this area is a tiled vinyl covering. It will be replaced with a heat sealed covering.
- 3.7 The ceiling is a standard tiled drop ceiling at a height of 7'-11". The hard deck is at a height of approximately 9'-6".
- 3.8 There are three (3) diffusers, **D1**, **D2** and **D3**, in the current area that are fed by the house HVAC system.
- 3.9 There are no return grilles in the **CSP Area**.
- 3.10 There are three (3) heating and cooling units, one in each room, in the vestibule inside the entry doors. These will be removed during renovation and the associated ducting removed.
- 3.11 There are three (3) fire sprinklers, **FS1**, **FS2**, and **FS3**, in what will be the **CSP Area**. These may be relocated during renovation and additional sprinklers added according to code.
- 3.12 The existing interior wall construction is wallboard with metal studs. They will need to be sealed with an epoxy coating. The exterior wall construction is concrete.
- 3.13 A section of **Wall #2** and **Wall #3** will be demolished during renovation to create a hallway to the **Buffer Zones**.
- 3.14 A door will be installed in **Wall #1** from **Room 106** and will be the primary entrance/egress to the **Anteroom** and the **Buffer Zones**.
- 3.15 There are three (3) windows, one (1) in each room, that will be removed, and the openings closed and sealed.
- 3.16 All bathroom walls, **Doors #2**, **#4** and **#6** and fixtures will be removed.
- 3.17 Existing lighting in this room may be added, changed or relocated during renovation. Cleanroom lighting systems are preferred.
- 3.18 There are three (3) sinks this area. One hands-free sink will be relocated in the **Anteroom** and two sinks will be removed.
- 3.19 **Doors #1**, **#3** and **#5** will be removed and the door space closed and sealed.

* In 1999, **Medical Air Solutions** defined and created the phrase **medical-grade™** to air purification systems. **The definition:** An air purification device that is individually tested with a laser particle counter to confirm a 99.9+% total system efficiency. Additionally, the unit shall be tested to confirm actual CFM delivery with all air filters (stages) in place. Each unit is delivered with a certificate showing its precise total system efficiency and air delivery. Many use the term without individual testing or providing the certificate required to confirm the product as truly being “medical-grade” by this definition. Medical-grade is the highest grade given to any air purification system including such classifications as pharmaceutical-grade, and surgical-grade.

4.0 Drawing P-01-24-10-1-2

CSP Area – Proposed Renovation Layout and Materials of Construction

4.1 The importance of intra-room abstergent airflow dynamics, adequate air changes per hour (>30 ACH), as well as having the room under positive pressure (>+0.03), are prime considerations when designing any positive pressure room where harmful airborne pathogens or substances may be, or are, present. Each Air Purification System (APS) shall have excess capacity where balancing may be required.

All units are certified, gel sealed, ceiling mounted 99.99% HEPA units that are **medical-grade** and comply with state and federal “**Green**” initiatives (*see attached order sheet*).

It should be noted that this proposal is taking into consideration the adopted revisions issued by USP on December 3, 2007 with additional clarifications at various USP Webinars MAS attended during the spring of 2008. An updated FAQ can be viewed on the USP web site at: <http://www.usp.org/audiences/pharmacist/797FAQs.html>

4.1.1 **MAS** recommends a minimum of 35 Air Changes per Hour (ACH) for positive pressure **CSP Buffer Zones** (**USP** = 30 minimum) and 15 ACH for the **Anteroom** (**USP** calls for 12 ACH minimum). **Note:** Negative pressure **CSP Buffer Zones** are required to have a minimum of 12 ACH [**USP**]. **MAS** recommends a minimum of 35 ACH for a negative pressure **Buffer Zone** to maintain a minimum ISO 7 cleanroom environment)

4.1.2 **MAS** recommends a minimum of +0.03” W. C. (Water Column) to be maintained in a positive pressure **CSP Buffer Zone** (**USP** range is +0.02” - +0.05 W. C.) with not more than +0.015 W. C. in the **Anteroom** (**USP** calls for +0.01 ACH as the target). **Note:** Negative pressure **CSP Buffer Zones** are required to have a minimum of -0.01” W. C. (**USP**). **MAS** recommends a maximum of +0.015” W. C. for the positive pressure **Anteroom**.

4.1.3 The overriding requirement is that the pressure difference in pressure between any **Buffer Zone** and the **Anteroom** are a minimum of 0.02” W. C.

4.1.4 **IMPORTANT:** The workstations, after renovation, will normally be in a considerably smaller area than they were before renovation. The heat load from the unit(s) will not be dissipated as efficiently as when they were in a larger area. While **MAS** can supply a chilled water cooling coil for those renovations where the air supply is not from the HVAC system, some type of cooling will need to be provided to maintain the supply air at 60°F or below and ensure the temperature in the **Buffer Zone(s)** is maintained at ~68°F. If a heat pump or other type of cooling device is specified, ensure all equipment adding to the heat load in the area is taken into consideration.

4.1.5 If not already available, a particle counter will be included as an option in this proposal. Particle count and CFU (colony forming unit) values are required to track the **CSP Buffer Zones** and **Anteroom** integrity.

- 4.1.6 **MAS** can also provide pathogen testing on the schedule defined by **USP <797>** for high risk and low/medium risk areas. The desired testing solution is to have an **Active Air Sampler** unit which **MAS** can provide as an option.
- 4.1.7 Any furniture, workbenches and cabinets in the created **CSP Buffer Zones** are to be relocated to the **Anteroom** or elsewhere to reduce the flat surface areas in this room. **USP** has allowed for the storage of chemo drugs only in the chemo **Buffer Zone** which includes a refrigerator for cold storage and preferably a stainless steel wire rack system for non-refrigerated chemo items.
- 4.1.8 Final placement of equipment and instruments shall be field determined.
- 4.2 **CSP Buffer Zone 1 – MAS** is recommending two (2) Laminar Airflow Ceiling Diffuser Plenums (**LFD1-LFD2**) and two (2) exhaust grilles (**E1** and **E2**) to create and maintain a positive pressure environment in **CSP Buffer Zone 1**. **MAS** is recommending an external rooftop Air Purification System (**APS1**). This proposed layout will refer to **MAS Drawing P-01-24-10-1-2** for the following:
- 4.2.1 **APS System** – The **medical-grade AS2000EG-PP (APS1)** air purification system shall be installed on the roof as indicated on the drawing.
- 4.2.1.1 The **AS2000EG-PP** unit utilizes 200-240/60/3 power inverted to 24 VDC and draws 2.6 Amps at full speed.
- 4.2.1.2 Filters and other consumables can be accessed from the door on the side of the unit.
- 4.2.1.3 Air purification system **APS1** is a **medical-grade**, positive pressure unit supplying 99.99% HEPA filtered air to this room via **LFD1**. Recirculated supply air for **APS1** shall be from the **CSP Area** through **HP1**. The installing contractor shall supply a modulating damper to ensure that “freewheeling” of the fan/blower unit will not occur in either **APS1** or **HP1**.
- 4.2.1.4 An electrical disconnect (provided by others) will be mounted on the side of **APS1**.
- 4.2.1.5 Final specific roof positioning of the unit shall be field determined. Four (4) legs are supplied with the unit. The legs may be used to anchor the unit to the roof or the unit can be mounted on a curb. In some cases the roof units have utilized both to anchor the unit.
- 4.2.1.6 The balancing of volume airflow delivered and damper settings for the laminar airflow diffusers supplied from this unit will be set as follows (See Table 1):
- 4.2.1.6.1 **LFD1** and **LFD2** will deliver a minimum total of 860 CFM to **Buffer Zone 1** providing 35 air changes per hour (ACH).
- 4.2.1.6.1.1 **LFD1** will supply a minimum 360 CFM by setting damper **FCV1** to the position required for that airflow.
- 4.2.1.6.1.2 **LFD2** will supply a minimum 500 CFM by setting damper **FCV2** to the position required for that airflow.
- 4.2.1.6.2 **LFD3** will deliver a minimum total of 390 CFM to **Buffer Zone 2** providing 35 air changes per hour (ACH) in conjunction with the exhaust from **Hood unit #1**.
- 4.2.1.6.2.1 **LFD3** will supply a minimum 590 CFM by setting damper **FCV3** to the position required for that airflow.

- 4.2.1.6.3 **LFD4** and **LFD5** will deliver a minimum total of 860 CFM to the **Anteroom** providing 15 air changes per hour (ACH).
- 4.2.1.6.3.1 **LFD4** will supply a minimum 400 CFM by setting damper **FCV4** to the position required for that airflow.
- 4.2.1.6.3.2 **LFD5** will supply a minimum 290 CFM by setting damper **FCV5** to the position required for that airflow.
- 4.2.2 **Ceiling Exhaust Grilles** (Exhaust) – The exhaust grilles (**E1** and **E2**) will return air from **Buffer Zone 1**.
- 4.2.2.1 **E1** will return a minimum 260 CFM to **APS1**. See Table 1 for CFM values.
- 4.2.2.2 **E2** will return a minimum 400 CFM to **APS1**. See Table 1 for CFM values.
- 4.2.2.3 The above settings with **LFD1** and **LFD2** will provide a minimum 35 air changes per hour (ACH).
- 4.2.3 The balancing of volume airflow returning from **E1**, **E2**, **E3** and **E4** to **APS1** will be set utilizing **FCV6**. The A&E may determine that each return leg have a dedicated flow control valve.
- 4.2.4 **Workstation** – There shall be one (1) workstation (**LAFW unit #1**) in **CSP Buffer Zone 1**. It shall be positioned as depicted on the drawing.
- 4.2.4.1 **LAFW unit #1** obtains air from **CSP Buffer Zone 1**. The unit's motor/blower recirculation system will deliver air to the horizontal laminar flow diffuser after passing the air through a 99.97% HEPA (or better) filter.
- 4.2.4.1.1 This unit does not exhaust air outside the room.
- 4.2.5 **Existing Walls** – The existing walls in **Buffer Zone 1** will need to be sealed and covered with epoxy or similar type coating. To be performed by in-house personnel, a local contractor or a sub-contractor.
- 4.2.6 **Pass-Through 1** – There will be one pass-through from **Buffer Zone 1** to the hallway to be installed in **Wall "A"**.
- 4.2.7 **Lighting Units** – Lighting units should be a lay-in type, preferably, those that are designed for cleanroom use.
- 4.2.8 **Ceiling** – The **CSP Buffer Zone 1** ceiling will be a sealed cleanroom ceiling system. **MAS'** cleanroom ceiling system prevents air leakage between the ceiling plenum above and the occupied space below, thereby preventing the flow of contaminants into or out of the clean zone. Hold-down clips press each ceiling panel tightly onto a special vinyl gasket that is an integral part of the ceiling grid suspension members. This ceiling system is designed specifically for cleanroom applications.
- 4.2.8.1 The optional sealed ceiling framework and ceiling tiles shall be installed at the eight foot (8'-0") level with **LFD1**, **LFD2**, **E1**, **E2**, lighting fixtures, sprinkler heads and other ceiling penetrations sealed so that no air can pass between the room and space above.
- 4.2.9 **Floor** – The flooring is an existing heat-welded vinyl floor covering (with coving). Additional sealing may be required which may include:

4.2.9.1 Sealing **Buffer Zone 1** flooring including under the doorway from the **Anteroom to Buffer Zone 1 (Door #1)**.

4.2.10 **Room Sealing** – Other areas of **Buffer Zone 1** will need to be “sealed” to maintain correct ACH and dP. The following is a list of items and areas to be sealed (there may be other items or areas to be sealed not listed here):

4.2.10.1 *3' x 7' Primary Entrance Door (Door 1 from Anteroom)* – Ensure the bottom of the door has a minimum ½” gap. This shall be achieved with an adjustable slat on the bottom of the door that can widen the gap to 1” to maintain room pressure and allow proper airflow out of the room while maintaining correct pressure. Seal the top and sides with flame retardant gasketing. All doors from anterooms should be equipped with automatic door closers that will close the door within five (5) seconds from a full open position. **NOTE:** The prefab wall comes with the automatic door with closer, push bar and a 1” bottom gap adjustable bottom door slat.

4.2.10.2 *Light Switches and Receptacles* – Seal with flame retardant gaskets.

4.2.10.3 *Lighting Units* – Seal the interior of the lighting unit so that no air can pass between the room and the above interstice space.

4.2.10.4 *Wall and Ceiling Penetrations* – Those below the cleanroom ceiling shall be sealed with flame retardant material.

4.2.10.5 *Conduits, Ducts, etc.* – Those below the ceiling shall be sealed to prevent flow of air into or out of the room.

4.2.10.6 *Sprinkler* – The head should use a seal ring to seal to the sealed ceiling.

4.2.11 **TRRM Room Pressure Monitor 1** shall be installed to monitor the airflow direction and positive differential pressure in **Buffer Zone 1**. A “single remote sensor” model shall be installed as depicted on **Drawing P-01-24-10-1-2**.

4.2.11.1 This unit shall have local audible and visual alarms.

4.2.11.2 The monitor shall have the capability to sense airflow direction.

4.2.11.3 The unit shall **ALSO** monitor temperature and relative humidity.

4.2.11.4 This unit may have the capability to communicate with all major building automation systems if that option is selected.

4.2.11.4.1 The default communications protocol is BACnet.

4.2.12 **Additional Equipment** – The following additional equipment will ensure added safety of the **CSP Area** operation. The addition of UVGI to eradicate pathogens in the upper atmosphere of the room where air mixing is not 100% efficient.

4.2.12.1 One (1) UVGI (Ultraviolet Germicidal Irradiation) **LUWM136** wall device may be installed in **Buffer Zone 1** as depicted in **Drawing P-01-24-10-1-2**. UVGI will eradicate pathogens that congregate in the upper room area where the air mixing is least effective. This unit irradiates the upper room only and will not irradiate pharmacy personnel or others.

4.2.12.1.1 **UV1** is a wall mounted UVGI unit that irradiates a maximum of 240 square feet.

- 4.2.12.1.2 The unit should be installed so that the bottom of the unit is a minimum of seven (7) feet from the floor and a minimum of one (1) foot from the ceiling.
 - 4.2.12.1.3 A receptacle shall be installed near each unit's mounting area to provide electrical power or it may be hardwired.
 - 4.2.12.1.4 **SAFETY: Ensure all UVGI units are de-energized when performing maintenance above the seven foot level in this room.**
- 4.3 **CSP Buffer Zone 2 – MAS** is recommending one (1) Laminar Airflow Ceiling Diffuser Plenum (**LFD3**) to provide ultra-pure air with **Hood unit #1** creating and maintaining a negative pressure environment in **CSP Buffer Zone 2**. The rooftop Air Purification System (**APS1**) is described in Section 4.2.1. This proposed area layout will refer to **MAS Drawing P-01-24-10-1-2** for the following:
- 4.3.1 **Workstations** – There shall be one (1) workstation (**Hood unit #1**) in **CSP Buffer Zone 2**. It shall be positioned as depicted on the drawing.
 - 4.3.1.1 **Hood unit #1** obtains air from **CSP Buffer Zone 2**. The unit's motor/blower system will deliver air to the horizontal or vertical laminar flow diffuser after passing the air through a 99.97% HEPA (or better) filter.
 - 4.3.1.1.1 This unit shall exhaust =>800 CFM to the outside via dedicated duct to **OE1**.
 - 4.3.1.1.2 If a "booster" fan is required, this shall be quoted by a local installing contractor, **New & Associates, Inc.**
 - 4.3.1.1.3 The **Hood unit #1** exhaust with **LFD3** will provide a minimum 35 air changes per hour (ACH).
 - 4.3.2 **Ceiling APS Diffusers (Supply)** – See Section 4.2.1.6.2
 - 4.3.3 **Exhaust Grilles** – There will be no HVAC exhaust grilles in this area. All air will be exhausted by **Hood unit #1**.
 - 4.3.4 **Existing Walls** – The existing concrete block wall in **Buffer Zone 2** will need to be sealed and covered with epoxy or similar type coating. To be performed by in-house personnel, a local contractor or a sub-contractor.
 - 4.3.5 **Pass-Through 2** – There will be one pass-through from **Buffer Zone 2** to the hallway to be installed in **Wall "A"**.
 - 4.3.6 **Lighting Units** – Lighting units should be a lay-in type, preferably, those that are designed for cleanroom use.
 - 4.3.7 **Ceiling** – The **CSP Buffer Zone 2** ceiling will be a sealed cleanroom ceiling system. **MAS'** cleanroom ceiling system prevents air leakage between the ceiling plenum above and the occupied space below, thereby preventing the flow of contaminants into or out of the clean zone. Hold-down clips press each ceiling panel tightly onto a special vinyl gasket that is an integral part of the ceiling grid suspension members. This ceiling system is designed specifically for cleanroom applications.
 - 4.3.7.1 The optional sealed ceiling framework and ceiling tiles shall be installed at the eight foot (8'-0") level with **LFD3**, lighting fixtures, sprinkler heads and other ceiling penetrations sealed so that no air can pass between the room and space above.

- 4.3.8 **Floor** – The flooring is an existing heat-welded vinyl floor covering (with coving). Additional sealing may be required which may include:
- 4.3.8.1 Sealing the **Buffer Zone** flooring including under the doorway from the **Anteroom** to the **Buffer Zone (Door #2)**.
- 4.3.9 **Room Sealing** – Other areas of **Buffer Zone 2** will need to be “sealed” to maintain correct ACH and dP. The following is a list of items and areas to be sealed (there may be other items or areas to be sealed not listed here):
- 4.3.9.1 *3' x 7' Primary Entrance Door (Door 2 from Anteroom)* – Ensure the bottom of the door has a minimum ½” gap. This shall be achieved with an adjustable slat on the bottom of the door that can widen the gap to 1” to maintain room pressure and allow proper airflow out of the room while maintaining correct pressure. Seal the top and sides with flame retardant gasketing. All doors from anterooms should be equipped with automatic door closers that will close the door within five (5) seconds from a full open position. **NOTE:** The prefab wall comes with the automatic door closer, push bar and a 1” bottom gap adjustable bottom door slat.
- 4.3.9.2 *Light Switches and Receptacles* – Seal with flame retardant gaskets.
- 4.3.9.3 *Lighting Units* – Seal the interior of the lighting unit so that no air can pass between the room and the above interstice space.
- 4.3.9.4 *Wall and Ceiling Penetrations* – Those below the cleanroom ceiling shall be sealed with flame retardant material.
- 4.3.9.5 *Conduits, Ducts, etc.* – Those below the ceiling shall be sealed to prevent flow of air into or out of the room.
- 4.3.9.6 *Sprinkler* – The head should use a seal ring to seal to the sealed ceiling.
- 4.3.10 **TRRM Room Pressure Monitor 2** shall be installed to monitor the airflow direction and positive differential pressure in **Buffer Zone 2**. A “single remote sensor” model shall be installed as depicted on **Drawing P-01-24-10-1-2**.
- 4.3.10.1 This unit shall have local audible and visual alarms.
- 4.3.10.2 The monitor shall have the capability to sense airflow direction.
- 4.3.10.3 The unit shall **ALSO** monitor temperature and relative humidity.
- 4.3.10.4 This unit may have the capability to communicate with all major building automation systems if that option is selected.
- 4.3.10.4.1 The default communications protocol is BACnet.
- 4.3.11 **Additional Equipment** – The following additional equipment will ensure added safety of the CSP Area operation. The addition of UVGI to eradicate pathogens in the upper atmosphere of the room where air mixing is not 100% efficient.
- 4.3.11.1 One (1) UVGI (Ultraviolet Germicidal Irradiation) **LUWM136** wall device may be installed in **Buffer Zone 2** as depicted in **Drawing P-01-24-10-1-2**. UVGI will eradicate pathogens that congregate in the upper room area where the air mixing is least effective. This unit irradiates the upper room only and will not irradiate pharmacy personnel or others.

- 4.3.11.1.1 **UV2** is a wall mounted UVGI unit that irradiates a maximum of 240 square feet.
 - 4.3.11.1.2 The unit should be installed so that the bottom of the unit is a minimum of seven (7) feet from the floor and a minimum of one (1) foot from the ceiling.
 - 4.3.11.1.3 A receptacle shall be installed near each unit's mounting area to provide electrical power or it may be hardwired.
 - 4.3.11.1.4 **SAFETY: Ensure all UVGI units are de-energized when performing maintenance above the seven foot level in this room.**
- 4.4 **CSP Anteroom – MAS** is recommending two (2) Laminar Airflow Ceiling Diffuser Plenums (**LFD4** and **LFD5**) and two (2) exhaust grilles (**E3** and **E4**) to create and maintain a positive pressure environment in the **Anteroom**. The rooftop Air Purification System (**APS1**) is described in Section 4.2.1. This proposed area layout will refer to **MAS Drawing P-01-24-10-1-2** for the following:
- 4.4.1 **Ceiling APS Diffusers** (Supply) – See Section 4.2.1.6.3
 - 4.4.2 **Ceiling Exhaust Grilles** (Exhaust) – The exhaust grilles (**E3** and **E4**) will return air from **Buffer Zone 1**.
 - 4.4.2.1 **E3** will return a minimum 200 CFM to **APS1**. See Table 1 for CFM values.
 - 4.4.2.2 **E4** will return a minimum 290 CFM to **APS1**. See Table 1 for CFM values.
 - 4.4.2.3 The above settings with **LFD3** and **LFD4** will provide a minimum 15 air changes per hour (ACH).
 - 4.4.3 The balancing of volume airflow returning from **E1**, **E2**, **E3** and **E4** to **APS1** will be set utilizing **FCV6**. The A&E may determine that each return leg have a dedicated flow control valve.
 - 4.4.4 **Prefabricated Wall (Buffer Zones/Anteroom)** – A prefabricated wall is selected to separate the **Anteroom** from **Buffer Zone 1** and **Buffer Zone 2** rather than a studded drywall type. There will be one (1) prefabricated wall erected to create **CSP Buffer Zone 1** and the **Buffer Zone 2**. The wall shall be sealed and anchored to the floor, existing walls and the sealed ceiling.
 - 4.4.4.1 **Prefab Wall “A”** – This wall will separate the **Buffer Zones** from the **Anteroom**.
 - 4.4.4.1.1 Wall dimensions are 24'-0”L x 9'-0”H with two (2) door panels.
 - 4.4.4.1.2 This wall will have ½ transparent top panels.
 - 4.4.5 **Pass-Through 3** – There will be one pass-through from the **Anteroom** to the hallway to the **Office/Storage Room**.
 - 4.4.6 **Existing Walls** – The existing walls in the **Anteroom** will need to be sealed and covered with epoxy or similar type coating. To be performed by in-house personnel, a local contractor or a sub-contractor.
 - 4.4.7 **Ceiling** – The **Anteroom** ceiling will be a sealed cleanroom ceiling system. **MAS'** cleanroom ceiling system prevents air leakage between the ceiling plenum above and the occupied space below, thereby preventing the flow of contaminants into or out of the clean zone. Hold-down clips press each ceiling panel tightly onto a special vinyl gasket that is an

integral part of the ceiling grid suspension members. This ceiling system is designed specifically for cleanroom applications.

4.4.7.1 The optional sealed ceiling framework and ceiling tiles shall be installed at the eight foot (8'-0") level with **LFD4, LFD5, E3, E4**, lighting fixtures, sprinkler heads and other ceiling penetrations sealed so that no air can pass between the room and space above.

4.4.8 **Floor** – The flooring is an existing heat-welded vinyl floor covering (with coving). Additional sealing may be required which may include:

4.4.8.1 Sealing the **Buffer Zone** flooring including under the doorway from the **Anteroom** to the **Office/Storage Area (Door #3)**.

4.4.9 **Room Sealing** – Other areas of the **Anteroom** will need to be “sealed” to maintain correct ACH and dP. The following is a list of items and areas to be sealed (there may be other items or areas to be sealed not listed here):

4.4.9.1 *3' x 7' Primary Entrance Door (Door 3 from the Storage/Entry Room)* – Ensure the bottom of the door has a minimum 1/2" gap. This shall be achieved with an adjustable slat on the bottom of the door that can widen the gap to 1" to maintain room pressure and allow proper airflow out of the room while maintaining correct pressure. Seal the top and sides with flame retardant gasketing. All doors from anterooms should be equipped with automatic door closers that will close the door within five (5) seconds from a full open position. **NOTE:** The prefab wall comes with the automatic door closer, push bar and a 1" bottom gap adjustable bottom door slat.

4.4.9.2 *Light Switches and Receptacles* – Seal with flame retardant gaskets.

4.4.9.3 *Lighting Units* – Seal the interior of the lighting unit so that no air can pass between the room and the above interstice space.

4.4.9.4 *Wall and Ceiling Penetrations* – Those below the cleanroom ceiling shall be sealed with flame retardant material.

4.4.9.5 *Conduits, Ducts, etc.* – Those below the ceiling shall be sealed to prevent flow of air into or out of the room.

4.4.9.6 *Sprinkler* – The head should use a seal ring to seal to the sealed ceiling.

4.4.10 **TRRM Room Pressure Monitor 3** shall be installed to monitor the airflow direction and positive differential pressure in the **Anteroom**. A “single remote sensor” model shall be installed as depicted on **Drawing P-01-24-10-1-2**.

4.4.10.1 This unit shall have local audible and visual alarms.

4.4.10.2 The monitor shall have the capability to sense airflow direction.

4.4.10.3 The unit shall **ALSO** monitor temperature and relative humidity.

4.4.10.4 This unit may have the capability to communicate with all major building automation systems if that option is selected.

4.4.10.4.1 The default communications protocol is BACnet.

4.4.11 **Additional Equipment** – The following additional equipment will ensure added safety of the CSP Area operation. The addition of UVGI to eradicate pathogens in the upper atmosphere of the room where air mixing is not 100% efficient.

4.4.11.1 Two (2) UVGI (Ultraviolet Germicidal Irradiation) **LUWM136** wall devices may be installed in the **Anteroom** as depicted in **Drawing P-01-24-10-1-2**. UVGI will eradicate pathogens that congregate in the upper room area where the air mixing is least effective. These units irradiate the upper room only and will not irradiate pharmacy personnel or others.

4.4.11.1.1 **UV3** and **UV4** are wall mounted UVGI units that irradiate a maximum of 240 square feet each.

4.4.11.1.2 This unit should be installed so that the bottom of the unit is a minimum of seven (7) feet from the floor and a minimum of one (1) foot from the ceiling.

4.4.11.1.3 A receptacle shall be installed near each unit's mounting area to provide electrical power or it may be hardwired.

4.4.11.1.4 **SAFETY: Ensure all UVGI units are de-energized when performing maintenance above the seven foot level in this room.**

4.5 **HVAC System** – The HVAC unit (**HP1**) to provide heating and cooling for the **Anteroom** and **CSP Buffer Zones** is a (refer to **Drawing P-01-24-10-1-3**). Munters Model HCUc2410AAC-EBBE01M-BN0S00A0A0, 100% Outside Air Unit, active desiccant type, 230/3/60.

4.5.1 The unit may need either a flow control damper between the HVAC unit fan and the **APS1** fan, or, the fan in the HVAC unit may be disabled and simply use **APS1**'s fan to recirculate the air.

4.5.1.1 The HVAC (**HP1**) fan will be interlocked with the **APS1** fan so that HVAC unit's fan will start when **APS1**'s fan is powered off and stop with the **APS1**'s fan is powered on. This will ensure the **CSP Area** will continually supply conditioned air with the required air changes.

(Note that CFM values are rounded either up or down to the nearest 10 CFM)

Table 1 – CFM SCHEDULE for 35 Air Changes per Hour (ACH) in the Buffer Zones / 15 in the Anteroom					
APS Unit	Room Location	Maximum CFM	Supply CFM	Exhaust CFM	HEPA?
LFD1	Buffer Zone 1	Unknown	300	----	No
LFD2	Buffer Zone 1	Unknown	460	----	No
E1	Buffer Zone 1	Unknown	----	260	No
E2	Buffer Zone 1	Unknown	----	400	No
LFD3	Buffer Zone 2	Unknown	590	----	No
Hood #1 to OE1	Buffer Zone 2	Unknown	----	790	Unknown
LFD4	Anteroom	Unknown	400	----	No
LFD5	Anteroom	Unknown	290	----	No
E3	Anteroom	Unknown	----	200	No
E4	Anteroom	Unknown	----	190	No
Under Door	Anteroom to Room 106	N/a	----	200	No
(APS1 – AS2000EG with 99.99% HEPA)		TOTALS	2040	2040	----

*Buffer Zone 2 APS will be adjusted based on Hood unit #1's actual exhaust capability.

5.0 Drawing P-01-24-10-1-1

CSP Area – Current CSP Area Layout

- 5.1 The HVAC layout of this recirculating system is depicted on this **Drawing P-01-24-10-1-3**. This design is for informational purposes only. The A&E, **WDG | Architect Engineers** will generate a comprehensive CAD documents which will be the final design.
- 5.2 United States Pharmacopeia (USP) copied the design for the compounding of sterile preparations (CSP) positive pressure low/medium risk and anteroom from the AIA's design criteria for a surgical suite with the negative pressure chemo compounding area using the surgical suite and airborne infectious isolation rooms (AIIR).
- 5.3 Refer to the **MAS** document "*Current Comments*" Volume 8 Number 1 that is a distillation of the USP's engineering design requirements for a CSP area.
 - 5.3.1 **WDG** will have the final responsibility to specify HVAC heating/cooling equipment, exhaust grilles and other materials of construction.

6.0 Equipment and Installation (Read Carefully)

- 6.1 **2010 Complete Compliance Renovation** – The following is a list of construction materials and equipment as defined for this proposal. A quote with pricing is attached.
 - 6.1.1 One (1) **AirShield AS2000EG** air purification system (APS) with digital wall control panel. This unit will comply with federal and state "**Green**" initiatives.
 - 6.1.2 Three (3) LDF-SS Laminar Airflow Diffuser Plenum units, stainless steel, 2' x 4'
 - 6.1.3 Two (2) Laminar Airflow Diffuser Plenum units, stainless steel, 2' x 2'
 - 6.1.4 One (1) Munters Model HCUc2410AAC-EBBE01M-BN0S00A0A0 100% Outside Air Unit, active desiccant type, 230/3/60
 - 6.1.5 Three (3) **TRRM Room Pressure Monitors** with single (1) remote sensor each.
 - 6.1.6 Four (4) LUWM136 UVGI devices.
 - 6.1.7 One (1) particle counter.
 - 6.1.8 One (1) active air sampler.
 - 6.1.9 Three (3) **VTPT300** pass-throughs.
 - 6.1.10 Three (3) Cleanroom Sealed Ceiling Systems (complete with all hardware and fasteners).
 - 6.1.11 One (1) prefabricated wall will be required to create the **Buffer Zones** and the **Anteroom**. The cleanroom prefab walls have been selected. A ½ transparent prefab wall is standard to separate the **Buffer Zones** from the **Anteroom**.
 - 6.1.11.1 **Wall "A"**: 2 – Wall3Door-1/2t (3'-0" x 8'-0"), 4 – Wall4x8-1/2t (4'-0" x 8'-0"), 1 – Wall2x8-1/2t (2'-0" x 8'-0")
 - 6.1.12 Floor installation will be provided by the hospital's installing contractor.

- 6.1.13 Additional sealing of existing walls, if required, in the entire **CSP Area** will be performed by the installing contractor.
- 6.1.14 Labor and wiring for electrical connections from breaker panel(s) to equipment and instruments to be determined by the client. A local electrical contractor will be required to provide electrical service to the area with the **MAS** contractor to terminate APS and instruments if the **MAS** preferred contractor was selected to perform the installation.
- 6.1.15 The cost of relocating or replacing existing lighting and adding/installing additional light fixtures and any relocation of, or new, conduit and providing wiring shall be performed in-house or by a licensed electrician.
- 6.1.16 A licensed fire sprinkler company must lower the existing sprinklers and add a minimum of one sprinkler in the created hallway.
- 6.1.17 Booster fans, ducting, grilles, dampers, transitions, system balancing and other HVAC equipment shall be provided by the installing contractor. Note that after renovation, all airflows to and from the **CSP Area** will be a constant CFM, **not** variable.
- 6.1.18 Plumbing fixtures, piping and material for installing, relocating or converting a sink to a hands-free model shall be provided by the installing contractor.
- 6.1.19 Wall, ceiling and/or roof penetrations or roof mounting and ducting of booster fans will be provided by the installing contractor.
- 6.1.20 **MAS recommends that all APS, pressure monitors and UVGI devices be on the emergency power system where possible.**
- 6.1.21 The heating/cooling roof unit cost will be included in the installing contractors quote.
- 6.2 The attached "*Wall Panels and Ceiling Confirmation List*" will be returned with your purchase order. If there are irregularities in the room (the room not being completely square or rectangular) attach a precise drawing denoting all dimensions.
- 6.2.1 Note that any full transparent or opaque walls that are desired must be selected on this form. One half (upper) transparent walls are standard.
- 6.3 This is a custom designed project. **MAS** requires a fifty per cent (50%) deposit on all equipment, instruments and materials of construction that we provide. This shall not include any deposit that may be required by the contractor or other vendors. Once **MAS** places any order with our suppliers, it may not be cancelled.
- 6.4 **MAS** will perform setup, commissioning and initial balancing of the equipment and instrument supplied upon completion of the project. If this is not possible and **MAS** must return at a later date, a fee and expenses will be invoiced.
- 6.5 An estimate for installation will be provided by the **MAS'** preferred contractor, **American Medical Systems, LLC**, and will be provided under separate cover and included in the overall costing. This proposal shall be transmitted to **American Medical Systems**.
- 6.5.1 **American Medical Systems, LLC** may be contacted at:
- American Medical Systems, LLC**
780 N. W. 1201 Road
Odessa, MO 64076
- Phone: Mr. Harry Carr (816) 564-3096, (913) 384-3885 FAX
Mr. Mike Flood (913) 207-1029 Cellular

7.0 CSP Area Equipment, In-Service and Instrument Commissioning

- 7.1 **General Commissioning Information** – Commissioning by **MAS** ensures that, after the project is complete, the **CSP Area** will meet or exceed the engineering and design requirements stated in **USP General Chapter <797>** by energizing all APS and their control panels, instruments and any other equipment or instruments supplied.
- 7.1.1 Note that if the client elects to utilize the services of our approved installation contractor, **MAS** will guarantee that the engineering and design aspects of the **CSP Area** will pass any professional, governmental or authorized regulatory agency inspection.
- 7.1.2 If any **MAS** supplied equipment, materials and/or instruments do not meet the engineering or design requirements as outlined in **USP <797>**, **MAS** will, at our expense, remediate the deficiency(ies) to ensure the facility's **CPS Area** will pass any professional, governmental or authorized regulatory agency inspection.
- 7.2 **Commissioning Scheduling** – The **MAS** representative or **MAS** approved installing contractor will remain on-site for one (1) additional day after project completion to perform this function if the client is prepared to have this service performed. There is no additional charge for this service. If the client cannot move workstations and other necessary equipment to perform this on the day after the renovation/upgrade is complete, then the **MAS** representative or **MAS** approved installing contractor will return on selected date to perform this service.
- 7.2.1 If a return trip is necessary for commissioning and/or in-service, a daily fee of \$ 500.00 per day plus travel expenses will be billed to the client.
- 7.2.1.1 Payment is due on the day of service.
- 7.3 **Equipment/Instrument Commissioning Attendance** – It shall be the client's responsibility to have all necessary facilities personnel parties present during the commissioning process if the client deems this advisable.
- 7.3.1 Generally, the following personnel should be present during the commissioning process: Facilities (maintenance, HVAC, electrician, etc.), balancing personnel (if available) and any other staff that the client feels should be present.
- 7.3.2 This is not the "in-service" normally provided to the end user. The commissioning process defines the operational parameters associated with the operation of the installed systems and instruments.
- 7.4 **Commissioning of Air Purification and any Ancillary Systems (APS)** – The **MAS** representative or **MAS** approved installing contractor will energize all units and perform a "rough" balancing of all the APS installed during the installation to set the APS to deliver the CFM noted in this proposal. A formal balancing by a state and/or locally certified balancing person or company may be required by code. This shall be the responsibility of the client or installing contractor to have this performed.
- 7.4.1 The **MAS** representative or **MAS** approved installing contractor will set the APS to meet or exceed the CFM noted in this proposal. This includes any ancillary systems provided by **MAS**. Operation of the APS control panel will be demonstrated noting the speed control, filter differential pressure switch and the UVGI lamp operation, if that option was installed.

- 7.4.2 If a heat pump or chilled water cooling coil system (fan powered or non-fan powered) not provided by **MAS** is to be commissioned, then this will be commissioned by the client or the installing contractor either before or during the **MAS** commissioning and in-service.
- 7.4.2.1 If air is to be supplied from the HVAC system, ensure the air being delivered is <60° F. It is important to note that if a cooling coil or heat pump is to be installed, all equipment generating a heat load should be taken into consideration when specifying the heat pump or chilled coil.
- 7.4.3 The **MAS** representative or **MAS** approved installing contractor will advise and/or assist any third party trades-people or contractors to ensure the installation/renovation performs as per this proposal.
- 7.5 **Commissioning of Instrumentation** – The **MAS** representative or **MAS** approved installing contractor will energize all instruments and controls supplied by MAS and installed during the installation noted in this proposal.
- 7.5.1 The **MAS** representative or **MAS** approved installing contractor will set the instruments to operate as per the requirement stated in this proposal.
- 7.5.2 Any third party instruments, sensors, safety or security devices, etc. shall be energized, calibrated and certified by the client or the client's personnel or the client's installing contractor.
- 7.6 **In-Service Attendance** – The in-service is primarily for any end user that works in or performs any function in the CSP Area. It shall be the client's responsibility to have all parties they consider necessary present during this in-service.
- 7.6.1 Generally, the following personnel should be present during the commissioning process: Facilities (maintenance, HVAC, electrician, etc.), Pharmacy Supervision/Management, pharmacists, pharmacy technicians, housekeeping (for cleaning instructions) and any other staff that the client feels should be present.
- 7.6.2 **MAS** will have installed the equipment and instruments so that, when commissioned, this is essentially a "set and forget" system. Unless the HVAC system or further renovations take place, the system will resume their functions, even after recovering from a power interruption.
- 7.6.3 All manual(s) and technical information on the equipment, materials and instruments will be transferred to the Facilities and Staff at this time unless this has already been accomplished.
- 7.7 **MAS Guarantee** – All equipment, materials and instrumentation we provide as well as the installation we provide via our "approved" installation contractor will and does meet the presently written USP General Chapter <797> guidelines and standards. **MAS** further guarantees that this installation will pass a JCAHO inspection (or State Board of Pharmacy requirements or inspection by its assigned authorized agents) provided; air balancing changes to the **MAS** specification have not been made or the sealing of walls and ceilings, where applied by MAS, have not been altered, up to within six (6) months of the installation's initial commissioning by **MAS** or its assigned agents.

Approved:

Robert H. Wiltbank, COO
Vice President of Engineering & Technology
Medical Air Solutions, LLC.
3080 Brookview Drive
Marietta, GA 30068-3813
<http://www.medicalairsolutions.com>
Corporate@medicalairsolutions.com
(800) 645-1059 Toll Free
(770) 321-6349 Facsimile
(770) 977-1407 Corporate – Atlanta
(770) 377-3884 Cellular

Attachments:

Page 18 – Drawing P-01-24-10-1-1
Page 19 – Drawing P-01-24-10-1-2
Page 20 – Drawing P-01-24-10-1-3
Page 21 – Order Checklist
Page 22 – MAS Line Quote
Page 23 – MAS Guarantee of Performance
Page 24 – Wall Panels and Ceiling Dimensions Confirmation List
Page 25 – AS2000EG Specification Sheet
Page 26 – TRRM Specification Sheet
Page 27-28 – Unitee Cleanroom Ceiling System
Page 29 – Cleanroom Wall System Specification Sheet
Page 30 – ParticleScan CR Spec Sheet
Page 31 – “Pass-through” Spec Sheet
Page 32 – Active Air Sampler Spec Sheet

Contacts

Dr. Curtis Hebert, Director of Pharmacy
1001 Gause Blvd.
Slidell, LA 70458
(985) 649-8898 (Direct)
(985) 649-8655 (FAX)
hebetcu@smhplus.org

Mr. Ben Galloway, Facility Services Director
(985) 649-8678 (Direct)
(985) 649-8655 (FAX)
gallowayb@smhplus.org

Mr. Chuck Dammon
Dammon Engineers
1095 Florida Ave.
Slidell, LA 70458
(985) 649-5832 (Office)
chuckdammon@yahoo.com

Mr. Emory Byrd
E. Byrd & Associates
3016 20th Street
New Orleans, LA 70163
(504) 754-5271 (Office)
(504) 754-5275 (FAX)
ebyrd@bellsouth.net

Drawing P-01-24-10-1-1

Slidell Memorial Hospital - Renovation Area

Current Area Configuration

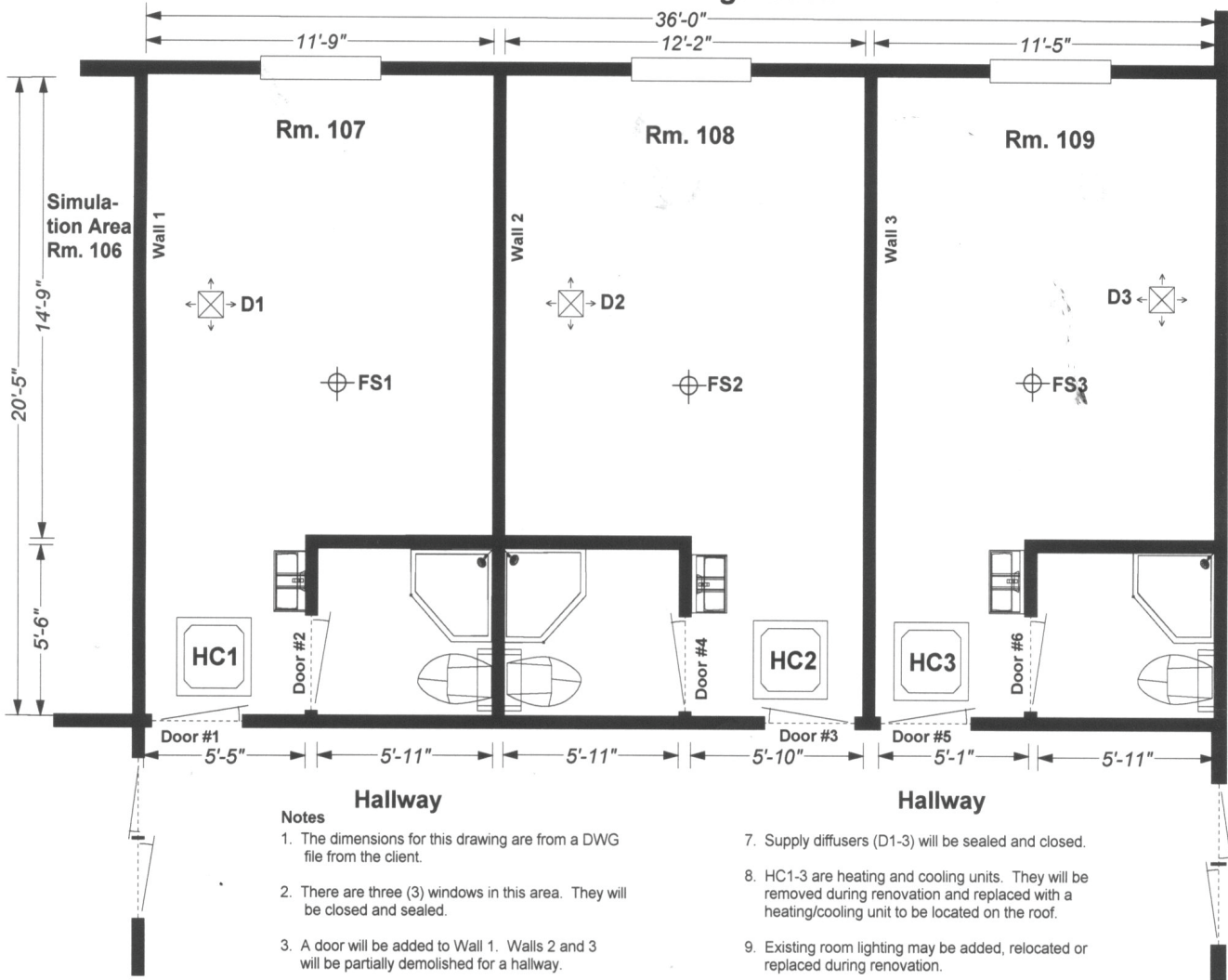

Notes

- The dimensions for this drawing are from a DWG file from the client.
- There are three (3) windows in this area. They will be closed and sealed.
- A door will be added to Wall 1. Walls 2 and 3 will be partially demolished for a hallway.
- Bathroom walls and doors will be removed. All bathroom fixtures will be removed. Two (2) of the three (3) sinks will be removed.
- The flooring in these rooms is a tiled vinyl covering. It will be replaced with a heat sealed covering.
- The ceilings in the rooms are a standard drop ceiling at a height of 7'-11". The hard deck height is at 9'-6". The ceiling in the vestibule area is at approx. 7'-0". The ceiling will be replaced with a cleanroom sealed ceiling system.
- Supply diffusers (D1-3) will be sealed and closed.
- HC1-3 are heating and cooling units. They will be removed during renovation and replaced with a heating/cooling unit to be located on the roof.
- Existing room lighting may be added, relocated or replaced during renovation.
- Existing fire sprinklers (FS1-3) may need to be relocated and lowered during renovation. Additional sprinklers will be required to meet code.
- Doors #1, #3 & #5 will be closed and sealed. Doors #2, #4 & #6 will be removed with walls.
- This area is located on the first floor. The outside roof is directly above this area.

Facility Address:
 1001 Gause Blvd.
 Slidell, LA 70458

Room 107	Room 108	Room 109
False Ceiling height = 7'-11" Hard Ceiling height = 9'-6"	False Ceiling height = 7'-11" Hard Ceiling height = 9'-6"	False Ceiling height = 7'-11" Hard Ceiling height = 9'-6"
Total Room Area = 208 ft. ² Total Room Volume = 1,976 ft. ³	Total Room Area = 217 ft. ² Total Room Volume = 2,062 ft. ³	Total Room Area = 201 ft. ² Total Room Volume = 1,910 ft. ³
To obtain minimum 35' ACH: 1976 ft. ³ x 35 ACH = 1153 CFM 60 Min./hr. <i>(For informational purposes only.)</i>	To obtain minimum 35' ACH: 2062 ft. ³ x 35 ACH = 1203 CFM 60 Min./hr. <i>(For informational purposes only.)</i>	To obtain minimum 35' ACH: 1910 ft. ³ x 35 ACH = 1115 CFM 60 Min./hr. <i>(For informational purposes only.)</i>

Medical Air Solutions, LLC	
Drawing History	
Drawing P-01-24-10-1-1	Author
Original: 03/17/10	RHW
Revised:	
Revised:	
Revised:	
Revised:	

© Copyright 2010 - Medical Air Solutions, LLC

Drawing P-01-24-10-1-2

Slidell Memorial Hospital - Renovation Area Proposed Area Configuration

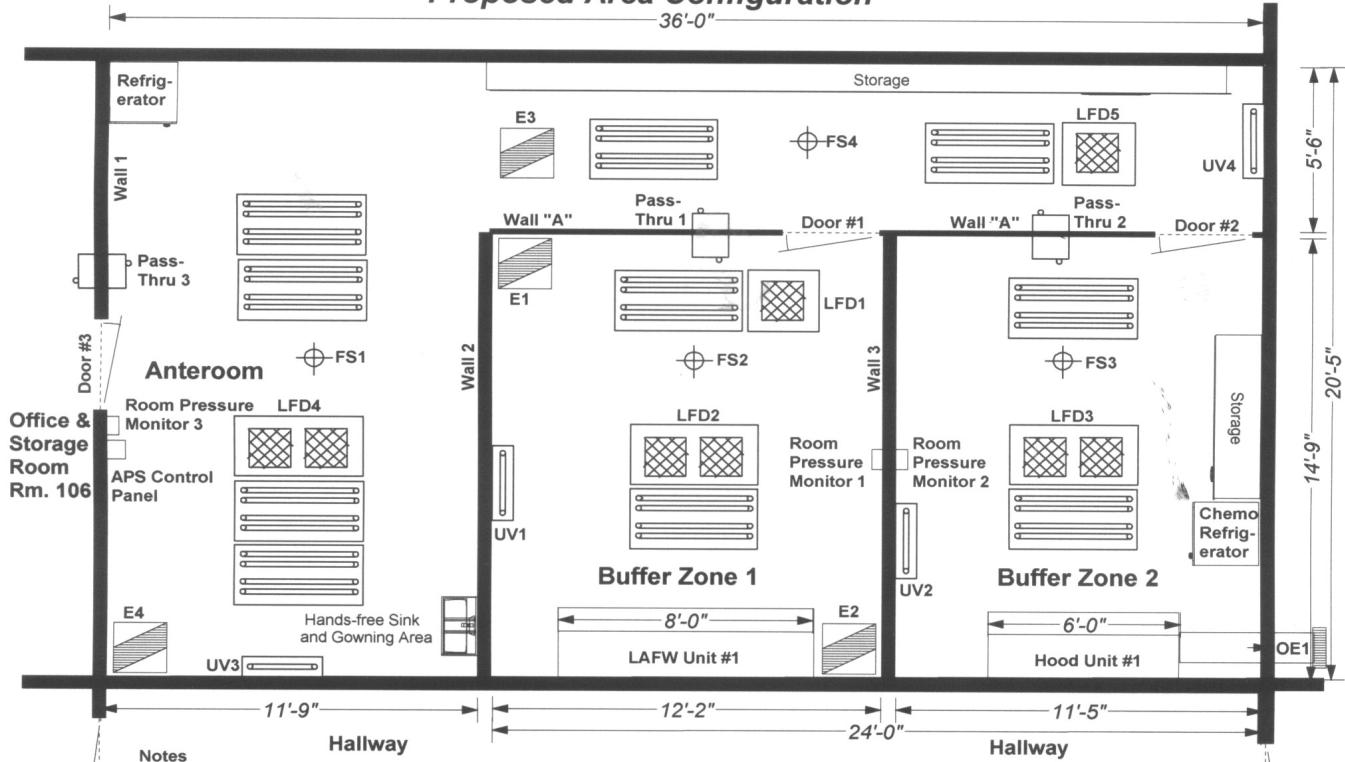

Notes

1. LAFW unit #1 is an ISO 5 CSP workstation utilizing horizontal laminar airflow system. (New unit to be purchased by client)
2. Hood unit #1 unit is an ISO 5 negative pressure workstation that exhausts air to the outside via a dedicated duct (OE1) to the roof. The hood will provide the negative pressure in Buffer Zone 2 with APS1 providing ultra-pure air. (New unit to be purchased by client)
3. APS1 is a roof HEPA air purification system capable of providing up to 2200 CFM of ultra-pure air to the CSP Area. Heating and cooling will be provided by HP1 to be installed up-stream from APS1. See drawing P-01-24-10-1-3 for HVAC details.
4. There are five (5) laminar airflow 304 SS diffuser plenums (HD1-5) providing supply air from the rooftop APS unit.
5. There are four (4) 304 SS exhaust grilles (E1-4). Exhaust air will be returned to APS1.
6. All windows in this area will be closed and sealed.
7. The flooring in this area shall have a contiguous, impervious cover installed or an epoxy coating over the existing tile applied.
8. The existing drop ceiling and hard ceiling in the area will be replaced with a cleanroom type, sealed ceiling, specifically designed for this application.
9. Room lighting may need to be relocated, replaced or added during renovation.
10. Part of walls 2 and 3 will be demolished to create a hallway to the Buffer Zones 1 and 2. Wall 2 will be 14'-9". Wall 3 will be 14'-7 1/4".
11. Door #3 will be hung in Wall 1 to provide access to the created CSP Area from the Office/Storage Room.
12. Wall "A" will be a cleanroom prefab wall system with the upper half to be transparent. It will be erected to separate Buffer Zone 1 and Buffer Zone 2 from the Anteroom. All existing walls will be sealed with an epoxy coating.
13. There are four (4) fire sprinklers (FS1-FS4) denoted in this area. Additional sprinklers may be required by code (by others).
14. All existing supply diffusers (D1-D3) in Drawing 1-1 will be closed and sealed.
15. UV1, UV2, UV3 and UV4 are UVGI devices that may be located as depicted. These units cover a maximum of 240 sq. ft. each.
16. Room Pressure Monitors 1, 2 and 3 and the APS Control Panel (APS1) will be located in the general area depicted on this drawing.
17. A 32-34" ADA approved hands-free sink will be located in the approximate located indicated.
18. There are two pass-throughs (1 and 2) that may be used to pass items to and from the Buffer Zones to the Anteroom. An additional pass-through may be desired to avoid the opening of Door #3 to the Office/Storage Room (Room 106).
19. Final placement of storage units, tables, etc. will be at the client's discretion.
20. Final placement of equipment and instruments will be field determined.

Facility Address:

1001 Gause Blvd.
Slidell, LA 70458

<p>Buffer Zone 1 Sealed Ceiling height = 8'-0" Hard Ceiling height = 9'-6"</p> <p>Total Room Area = 184 ft² Total Room Volume = 1,472 ft³</p> <p>To obtain minimum 35 ACH: $\frac{1472 \text{ ft}^3 \times 35 \text{ ACH}}{60 \text{ Min./hr.}} = 859 \text{ CFM}$ <i>Positive offset of 300 CFM Offset air to be exhausted under access door.</i></p>	<p>Buffer Zone 2 Sealed Ceiling height = 8'-0" Hard Ceiling height = 9'-6"</p> <p>Total Room Area = 169 ft² Total Room Volume = 1,352 ft³</p> <p>To obtain minimum 35 ACH: $\frac{1352 \text{ ft}^3 \times 35 \text{ ACH}}{60 \text{ Min./hr.}} = 789 \text{ CFM}$ <i>Negative offset of 300 CFM. Offset air to be exhausted by Hood to OE1.</i></p>	<p>Anteroom Sealed Ceiling height = 8'-0" Hard Ceiling height = 9'-6"</p> <p>Total Room Area = 343 ft² Total Room Volume = 2,744 ft³</p> <p>To obtain minimum 15 ACH: $\frac{2744 \text{ ft}^3 \times 15 \text{ ACH}}{60 \text{ Min./hr.}} = 686 \text{ CFM}$ <i>Positive offset of 200 CFM Offset air to be exhausted under access door.</i></p>
---	---	--

Medical Air Solutions, LLC	
Drawing History	
Drawing P-01-24-10-1-2	Author
Original: 03/18/10	JRB
Revised:	
Revised:	
Revised:	
Revised:	

Drawing P-01-24-10-1-3

Slidell Memorial Hospital - Renovation Area
Proposed Area Configuration - HVAC

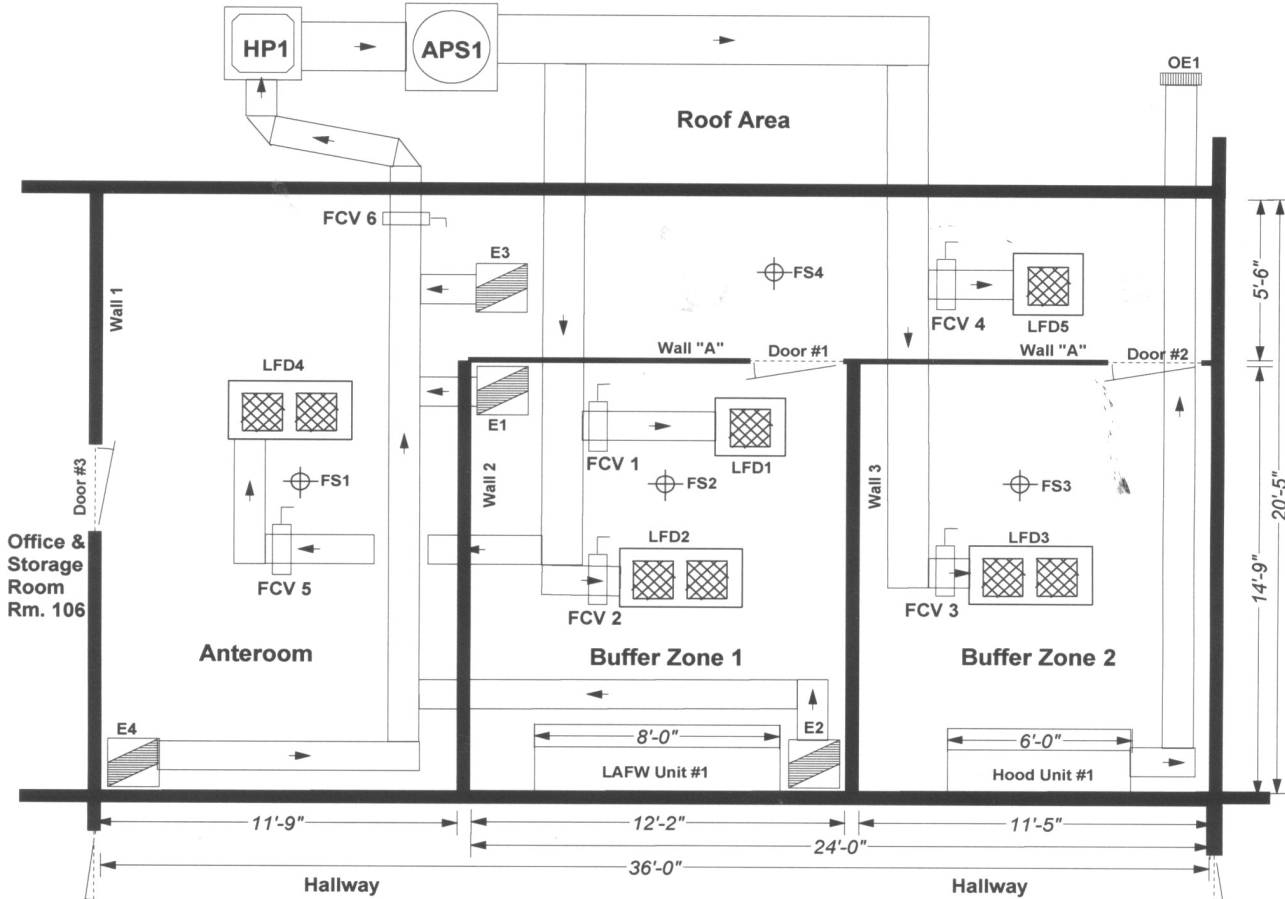

Notes

1. APS1 is a roof air purification system capable of providing up to 2200 CFM of ultra-pure air to the CSP Area. The unit has a prefilter and 99.99% HEPA to provide ultra-pure air to the CSP Area. This is a recirculating with a fresh air intake at HP1.
2. Supply ducting to the CSP Area must be either 304 SS or anodized aluminum. Sizing of ducting will be by A&E.
3. Heating and cooling will be provided by HP1 which will be installed up-stream from the APS1. Tonnage and manufacturer to be determined by A&E.
4. Diffusers and grilles and their plenums will be constructed of 304 SS.
5. The flow control dampers (FCV 1-5) will be utilized to balance the air volume into the CSP Area via the LFD diffusers. (See the CFM Schedule in the written proposal.)
6. The flow control damper (FCV 6) will be utilized to balance the air volume from the CSP Area via the exhaust grilles. (See the CFM Schedule in the written proposal.)
7. Hood unit #1 will exhaust air to the outside via a dedicated duct to OE1. MAS recommends a booster fan at the terminus of the duct run to ensure the ducting maintains a negative pressure.
8. Temperature in the CSP Area should be between 66 and 70 degrees F with the humidity between 30-50%.

<p>Buffer Zone 1 Sealed Ceiling height = 8'-0" Hard Ceiling height = 9'-6"</p> <p>Total Room Area = 184 ft.² Total Room Volume = 1,472 ft.³</p> <p>To obtain minimum 35 ACH: $\frac{1472 \text{ ft.}^3 \times 35 \text{ ACH}}{60 \text{ Min./hr.}} = 859 \text{ CFM}$</p> <p><i>Positive offset of 300 CFM Offset air to be exhausted under access door.</i></p>	<p>Buffer Zone 2 Sealed Ceiling height = 8'-0" Hard Ceiling height = 9'-6"</p> <p>Total Room Area = 169 ft.² Total Room Volume = 1,352 ft.³</p> <p>To obtain minimum 35 ACH: $\frac{1352 \text{ ft.}^3 \times 35 \text{ ACH}}{60 \text{ Min./hr.}} = 789 \text{ CFM}$</p> <p><i>Negative offset of 300 CFM. Offset air to be exhausted by Hood to OE1.</i></p>	<p>Anteroom Sealed Ceiling height = 8'-0" Hard Ceiling height = 9'-6"</p> <p>Total Room Area = 343 ft.² Total Room Volume = 2,744 ft.³</p> <p>To obtain minimum 15 ACH: $\frac{2744 \text{ ft.}^3 \times 15 \text{ ACH}}{60 \text{ Min./hr.}} = 686 \text{ CFM}$</p> <p><i>Positive offset of 200 CFM Offset air to be exhausted under access door.</i></p>
---	---	--

Facility Address:
1001 Gause Blvd.
Slidell, LA 70458

Medical Air Solutions, LLC Drawing History	
Drawing P-01-24-10-1-3	Author
Original: 03/18/10	RHW
Revised:	
Revised:	
Revised:	
Revised:	



Medical Air Solutions, LLC

3080 Brookview Drive
Marietta, GA 30068-3813
www.medicalairsolutions.com
Corporate: 770.977.1407

Facsimile: 770.977.9964
Federal ID number: 56-2655231
DUN's Number: 076355549
Corporate@medicalairsolutions.com

Order Checklist

When placing your order please make sure the following documents are completed and enclosed with your deposit check.

- Your formal written and signed purchase order
- Your 50% deposit check
- If you are a tax exempt institution, attached a copy of your tax exemption certificate
- Order specification sheet for the type of prefab wall system desired
- Order specification sheet for the sealed cleanroom ceiling system, w/ precise measurements at the ceiling, not the floor

Once all the appropriate information is received, manufacturing orders will be placed.

Thank you,

Lee G. Hadin
Managing Partner

© 1999- 2010 Medical Air Solutions, LLC. All Rights Reserved.

TotalAirSecurity™

"Objective Aerobiological Engineering Assessments & Solutions for Medical Professionals"

Visit our Web Site at: www.medicalairsolutions.com

E-Mail: LeeHadin@medicalairsolutions.com

Quotation

From



Medical Air Solutions, LLC

TO: Curtis Hebert, Pharm. D., Pharmacy Director
Slidell Memorial Hospital
1001 Gause Blvd.
Slidell, LA 70458

Quotation valid for 60 days
Date: March 22, 2010

Line Quote FOR: Equipment and Installation to Create a CSP Area for USP 797 Compliance
(This quote represents the cost of instruments, equipment, materials and installation that MAS supplies ONLY)

Description:

- 1 – *AirShield*™ AS2000EG rooftop mounted positive pressure supply APS (Does **not** include insulation)
 - 1 – Munters Model HCUc2410AAC-EBBE01M-BN0S00A0A0 HVAC unit for heating, cooling with temp and rH control
 - 3 – Laminar Airflow Diffuser Plenums, stainless steel, 2’ x 4’
 - 2 – Laminar Airflow Diffuser Plenums, stainless steel, 2’ x 2’
 - 4 – Return Grilles 304 stainless steel 2’ x 2’
 - 3 - TRRM Remote Sensor Room Pressure Monitors
 - 3 - Cleanroom ceiling systems – Anteroom & 2 Buffer Zones (Complete)
 - 1 - Prefabricated wall (**Wall “A”**) with 2 doors, hardware, fasteners, etc.
 - 3 x “Pass-through” @ 3,990.00 ea.
 - 1 x Particle Counter @ 3,695.00 ea.
 - 1 x Active Air Sampler @ 1,995.00 ea.
 - 4 x LUWM136 UVGI Units @ 1,480.00 ea.
- Engineering/Design (includes commissioning and on-site, in-service as indicated in Section 6.0)
Shipping
Installation of MAS supplied CSP area by American Medical Systems included
Discount calculated for all Amerinet listed items included (**Amerinet Contract VH10166**)

Warranty:

- AS2000EG-PP/NP: Three (3) years parts and materials
- TRRM Monitor and UVGI: Two (2) years parts and materials
- Particle Counter/Air Sampler/Pass-Through: One (1) year parts and materials

Shipping:

Prepaid and added to the invoice.

Delivery:

<45 days ARO

Conditions:

A valid written purchase order is required from hospitals, medical institutions, their clinics or a MAS pre-approved leasing company or bank. We accept VISA, MasterCard and Discover Card payments (4% fee charged).

Terms:

Fifty per cent (50%) deposit with order. Balance due upon delivery of equipment. FIRM. **A delayed payment beyond terms will incur a one and a half percent (1½%) charge per month on any unpaid balance.**

End:

2008 Compliance Items with Installation not to exceed

\$171,793.06

S/ 

Lee G. Hadin, Managing Partner
Medical Air Solutions, LLC

This quotation does not include any local, state or federal taxes that may be applicable. When ordering please attach a copy of your tax exempt status certificate, otherwise appropriate taxes will be added to the invoice. MAS is not, and will not be responsible for any taxes due on such order.

Guarantee of Performance

by

Medical Air Solutions, LLC

Celebrating our 10th Year of Supporting Healthcare Professionals

for

**Upgrade of _____, _____, _____, _____
CSP to meet current USP Chapter <797> standards in effect and
published December 3, 2007**

Completed & commissioned on the _____, of _____, 2010.

MAS guarantees all equipment, materials and instrumentation we provide, as well as the installation via our "approved" installation contractor, meets the presently written USP General Chapter <797> guidelines and standards. **MAS** further guarantees that this installation will pass any governmental or authorized private agency inspection (such as, State Boards of Pharmacy, JCAHO or other authorized agencies) up to within six (6) months of the installation's initial commissioning by **MAS** or its assigned agents, provided that air balancing changes to the **MAS** specification have not been made or the sealing of walls and ceilings (when installed by MAS) have not been altered.

Medical Air Solutions, LLC certifies all equipment and or materials delivered for the HEPA air purification systems utilized in this above described upgrade have been visually inspected as well as tested to confirm delivery of stated specifications prior to shipment. Such testing and inspection documents are available upon written request.



S/: _____
Robert H. Wiltbank, VP Engineering & Technology



Wall Panels and Ceiling Dimensions Confirmation List

When placing a purchase order, please confirm all dimensions based in reference to the drawings provided in this document. Please call the MAS Engineer at 770-377-3884 if you have any questions about any doors, lighting fixtures or other items that may be provided with the wall and, if ordered, ceiling panels. MAS will assume that the wall height is our standard height of 8 feet.

Wall "A" Data

Wall Length 24 ft. 0 inches Height 8 ft. 0 inches Number of doors: 2 Number of windows 0

Standard Door? Yes No or **Wide Door?** Yes No Length ft. inches Height ft. inches

Opaque Wall? Yes No or **Half Transparent Wall?** Yes No **Full Transparent Wall?** Yes No

of wall outlets: Describe location on wall

Other requirements:

Ceiling Data (MUST be accurate to within 1/8" – measure at ceiling)

CSP Anteroom

Length ft. inches Width ft. inches Number of lighting fixtures: Number of Sprinklers: (if any)

CSP Buffer Zone 1

Length ft. inches Width ft. inches Number of lighting fixtures: Number of Sprinklers: (if any)

CSP Buffer Zone 2

Length ft. inches Width ft. inches Number of lighting fixtures: Number of Sprinklers: (if any)

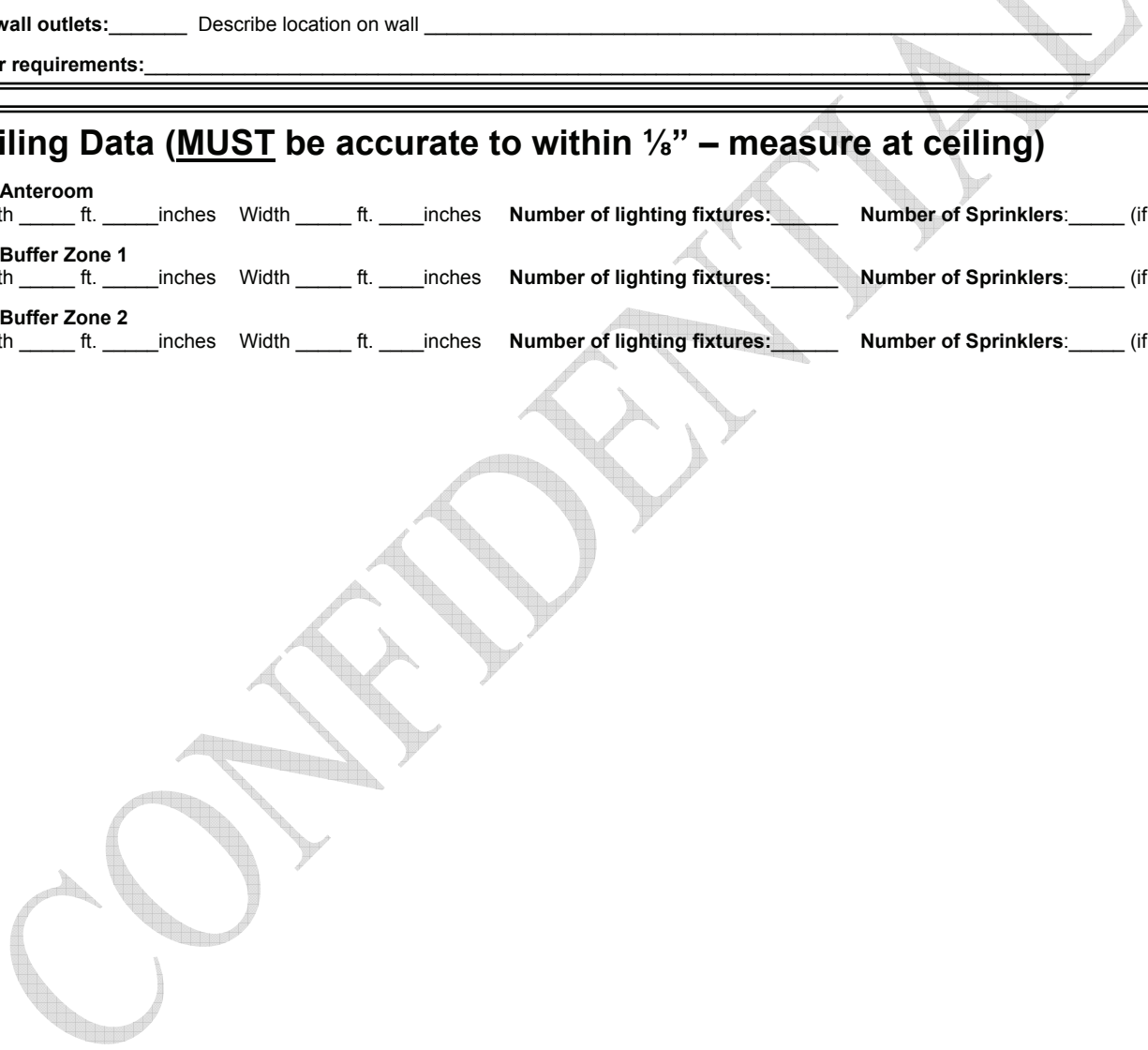



Medical Air Solutions, LLC

AirShield™ AS2000EG Roof Duct APS

Marietta, GA ♦ 800-645-1059 or Fax: 770-977-9964

General Overview

AirShield™ HEPA aerobiological purification systems provide *medical-grade** air cleansing with 21st century technologies. They comply with **RoHS**, Article 95, “**Green**” equipment initiative. The **AS2000EG** is an internal, in-line (ducted), HEPA air cleansing system designed to remove airborne micro-contaminants down to 0.01 μ m. The “**EG**” series is ideal for rooftop installations. They are used for recirculating, negative or positive pressure environments in isolation rooms, wards, waiting rooms, etc. The newly upgraded **AS2000EG** employs a powerful single motor/blower, a pleated, antimicrobial treated, 30% ASHRAE filter, a certified 99.99% HEPA filter in a steel alloy frame and, optionally, four (4) **UV-C** lamps generating **39,948 μ w/sec/cm²** of UV irradiation dosage on the capture side of the HEPA filter (**AS2000EG-UV**).

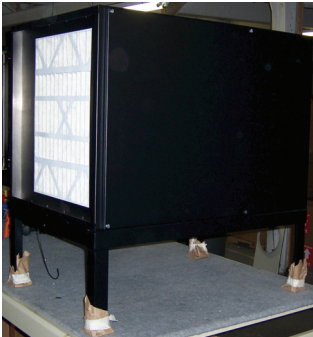

AS2000EG

Larger 3500 and 5000 CFM models are also available. .

- In 1999, **Medical Air Solutions** defined and created the phrase **medical-grade** to air purification systems. **The definition:** An air purification device that is individually tested with a laser particle counter to confirm a **100% total system efficiency**. Additionally, the unit shall be tested to confirm actual CFM delivery with all air filters (stages or elements) in place. Each unit is delivered with a **certificate** showing its confirmed total system efficiency and air delivery. Many use the term without individual testing or providing the certificate required to confirm the product as truly being “**medical-grade**” by this definition. **Medical-grade** is the highest grade or classification given to any air purification system including such classifications as pharmaceutical-grade, or surgical-grade.

TotalAir Security™

An **American** designed and manufactured product

“**AirShield**” & “**Total AirSecurity**” are trademarks of Medical Air Solutions

Specifications

Motor/Blower: One, (1) reverse curved impeller

Delivered Air: 2000 CFM \pm 5% on high, (certified)
Eight (8) speed settings
Recirculating, positive or negative pressure options

Electrical:
Components: UL Approved & listed
Voltage: 200-240/60/3 inverted to 24 VDC
Amps: 2.6 @ Max.
Connection: Hardwired (standard)
Safety: Access door kill switch
Breaker: Internal

Control: Lockable, digital, wall mounted control panel w/ eight (8) impeller fan speed settings; off/on, an on/off UV light indicator and a differential pressure monitor light that illuminates indicates a required HEPA filter change.

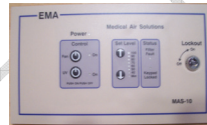

Optional UVGI:
No. of lamps: 4 x 25W UV-C Lamps
Lamp specs: 22”- standard 4 pin
UV Dosage: **39,948 μ -watt/sec/cm²**

Sound Level: 58 dBA High (ducted)
<54 dBA Low (ducted)

Pressure gauge: Digital monitor: 0-4” W.C.

Filters:
Pre-filter Pleated, 30% ASHRAE (12” x 24” x 4”) (Antimicrobial treated)
Final filter Certified 99.99% Super HEPA 24”x 24” x 11½”, G. S. alloy frame

Dimensions: 29”W x 54”L x 31”H

Transition access: 24” x 31” flanged, each end

Access Door: Sealed and bolted

Cabinet: Corrosion resistant treated .062 ga. Aluminum welded walls with steel struts

Base Weight: 115 lbs. Operating
131 lbs. Shipping

Capacity: Up to 12 ACH in 10,000 cu. ft

U. S. Warranty: Three (3) years parts, materials & workmanship





Medical Air Solutions, LLC

Room Pressure Monitors

Marietta GA 30068 • (800) 645-1059 • FAX (770) 977-9964

TRRM General & Technical Specifications:

Critical Room Control's **Room Pressure Monitor** is an advance compact control module that continuously monitors and/or controls room pressure and environment. The TRRM incorporates a bright colorful touch LCD screen interface to display a room's pressure status along with its pressure reading accurate to 0.001" Water Column. This monitor / controller is designed to be either recessed or surface mounted wherever monitoring is required. The TRRM gives personnel a clear, accurate, and unambiguous indication of its environment and alarm status.

The TRRM is capable of integration with building automation systems thru its onboard RS-485 Communication port or optional Daughter board. All menus are accessed through the intuitive touch screen that allows the user to quickly configure for the TRRM to monitor and/or control critical rooms.

SPECIFICATIONS:

Dimensions:

- Face plate: Height 5", Width 6.5", Depth 3.5"
- LCD Touch Screen: 4" Diagonal
- Optional 5.7" screen available

Network / Communications:

- RS485 physical network
- BACnet MS / TP
- MODBUS
- N2 – Johnson Controls

Differential Pressure Sensing / Controlling:

- Input signal options – 0 – 5 volts, 0-10 volts, 4-20mA, and Network – (.001" WC)
- Optional analog signal mirroring DP reading out to BAS (0-5 volts or 0-10 volts)
- Optional Pressure Control (PID) via dedicated 4-20mA (normal / reverse acting)

Temperature Sensing / Controlling:

- Input signal options – 0 – 5 volts, 0-10 volts, 4-20mA, and Network – (.1*)
- Optional Reheat Control (PID) via dedicated 0-5 volts or 0-10 volts (normal / reverse acting)
- Show / hide Temp and/or Temp Set Point on main screen
- Allow user to change Temp Set Point via password protected screen

Mounting

TRRM..... Surface or Flush optional w/ Flow Tube Cover Plate

Installation:

Separate contractor quotation may be required for your local installation. Normally, hospital maintenance or electricians can install a unit in less than two hours or local qualified contractors may install this system, otherwise MAS will provide custom quote for installation after review of building particulars and local codes.

Warranty:

Two (2) year parts, materials and workmanship.

Toll Free 800-645-1059 E-mail: Corporate@medicalairsolutions.com WWW: <http://www.medicalairsolutions.com>

© 1999-2010 Medical Air Solutions, LLC. All Rights Reserved. An **American** designed and Manufactured Product



Unitee Ceiling Systems

Product Overview

Unitee Ceiling Systems were developed as a cost-competitive alternative to solid and narrow screw-slot extruded aluminum tee-bar systems. Assembled by means of patented two-piece clips, Unitee is an aesthetically pleasing system that accommodates low-cost square-edge lay-in acoustic panels.

Applications

Unitee Ceiling Systems can be used in any retail, commercial or public space where steel tees or other unsealed extruded aluminum ceiling products would be installed.

Fully Accessible

A major feature of Unitee Series is that it can be easily removed and reinstalled providing access to the plenum space. Occasionally mechanical or electrical equipment fail requiring large areas of the ceiling to be removed. Some applications require that the entire ceiling be removed for cleaning the plenum space above the ceiling. Unitee Series uses the two-piece Universal Assembly Clips which allow the grid to be easily removed and reinstalled.

Note: Some states do not allow this type of ceiling to be installed in Operating Rooms. Check your state and local codes before considering the Unitee Ceiling for a surgical suite.

Finish

The standard finish for Unitee Series is B12 White Powder Coat. For optional and special finishes including anodizing see MAS for a color matrix.

Features/Benefits

- Accepts square-edge lay-in panels; panels are easily installed and removed for full plenum access.
- Unique connector clips provide rapid ceiling installation of ceiling members.
- Continuous screw slot for attaching partitions without damaging ceiling members.
- Thru-slot intersections for aesthetically pleasing appearance.
- Design flexibility - several profiles to choose from in any module size.
- Extruded aluminum construction for clean, crisp lines, maximum durability and rust proof performance. Choice of painted or anodized finishes.

Unitee CR Cleanroom Ceiling - is produced for hospital, laboratory, and other cleanroom areas where a gasketed system is required. A B11 finish is used to withstand strong cleaning solutions typically used in these areas. The aluminum T-bar, vinyl gasket, and hold down clips provide the tight air seal required in cleanroom ceilings.

Extrusions

The Unitee series is available in six T-bar extrusions and two wall molds:

#4667 is a 1 1/4" wide slotted T-bar. The T-bar incorporates a 3/8" threaded slot in the face. The continuous slot provides a system for mounting partitions or suspending signs. The slot also gives the ceiling high end architectural appearance not achievable with regular steel tees. The wide face allows for stable mounting of tiles or light fixtures.

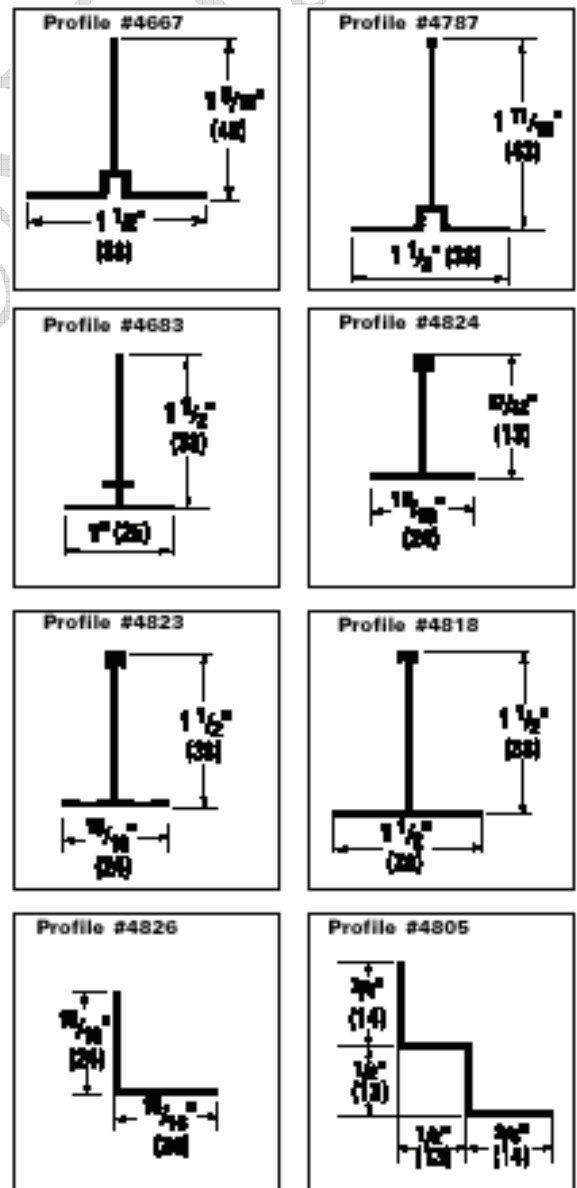

Any loading to be performed on the tee should be checked through the Application Engineering department.

#4787 has the same face appearance as the #4667 extrusion but has a taller stack and a bulb on top to provide more strength and rigidity.

#4683 is a one-inch wide by 1½" high T-bar.

#4824 is a 15/16" wide T-bar used for light-duty applications. This is used as a short cross tee that does not have to support much weight.

#4823 is a 15/16" T-bar used for many standard office applications. The 1½" height and bulb provide medium-duty support.

#4818 is similar to the #4823 but has a wider face that gives a more dominant T-bar appearance.

#4826 is a standard 15/16" wall mold that complements both slotted and solid face tees.

#4805 is a reveal or "shadow" mold. This wall mold creates the impression of a gap between the surface of the ceiling and the wall and hides imperfections in the wall.

#4806 is a 1½" wide T-bar. The heavy-duty T-bar is 1 15/16" high and is complete with an integral vinyl gasket and the provision for installation of hold down clips.

#4730 is similar to the #4806 in construction but is only 1¼" wide.

#4732 is also similar to the other cleanroom T-bar but is only 1" wide. This is the most common cleanroom tee as wider faces may prevent lights and diffusers from opening.

#4726 is a 1¼" cleanroom T-bar that incorporates a threaded slot.

#4733 is the cleanroom wall mold. The gasketing is located so that the tee is sealed at the wall as well as the ceiling panels.

SC is a simple aluminum ceiling panel with B11 finish. The SC series panels allow the ceiling to have the same durability as the T-bar and accommodates easy cleaning.

SPB is a perforated-face ceiling panel that has a sealed backpan. The SPB gives the same appearance as a laminar flow diffuser.

The Unitee CR series comes in four standard tees and one wall mold.

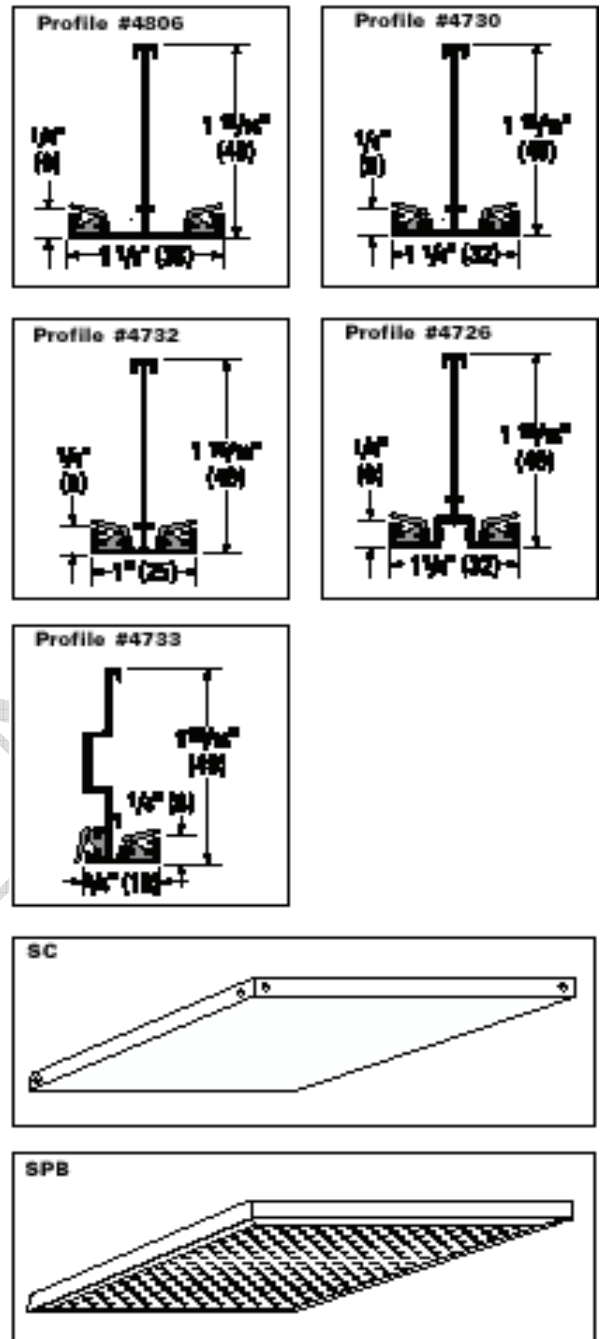



Medical Air Solutions, LLC

Prefab Wall System

Marietta GA 30068 • (800) 645-1059 • FAX (770) 977-9964

General Overview

Varitech cleanroom wall systems have been used worldwide to create cleanrooms for the pharmaceutical and electronics manufacturing industry. These types of cleanrooms are what we call “NASA Grade” cleanrooms due to the stringent standards for particles per cubic foot. Typically these rooms are, with the proper air supply system, able to maintain an ISO Class 3 or 4 (FS 209E Class 1 or 10) environment ensuring absolute sterility of the air.

The wall structure is framed using 6061 clear anodized extruded aluminum profiles. The panel options are anodized aluminum composite, black or white PVC. If a “see through” wall is desired (*Fig. 1 below*) then acrylic or polycarbonate wall panels may be used so that the interior can be viewed at all times. We can also create half transparent walls and doors or simply install windows in the aluminum, black or white panels.



*Fig. 1 - Electronics Printed Circuit Board Manufacturing Room
An ISO Class 3 Environment*

The supporting posts, doors and other connectors are all gasketed so that the sterile atmosphere is maintained. This includes the cleanroom ceiling that encloses the top of the room by connecting to the erected room’s wall panels or from an existing wall to the panels.

Standard Fastening Hardware

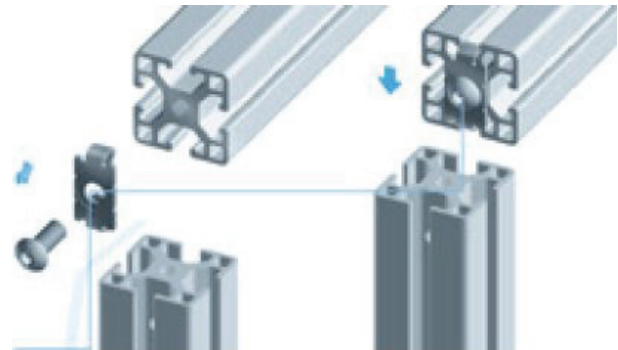

Fig. 1

Various posts can be utilized including a double wall system so that piping, tubing and conduit can be enclosed inside the two wall panels.



Medical Air Solutions, LLC

AirShield™ ParticleScan™ Pro

Marietta GA 30068 • (800) 645-1059 • FAX (770) 977-9964

General Overview

The **AirShield™ ParticleScan™ CR** is an advanced six (6) channel laser particle counter specifically designed to monitor and verify cleanrooms. Designed and manufactured in Switzerland it is a battery operated, hand-held, user friendly and easy to operate unit. It's provided with window-based soft-ware and USB cable to interface into either a laptop or desk, windows based, computer system. The memory chip inside the counter accumulates data which can be later downloaded to a computer for statistical analysis and graphing. The six channels allow for measurement of various size particles or can be set to collectively measure all airborne particle sizes down to 0.3µm. The **ParticleScan Pro** takes a six (6) second air sample, then calculates and displays the particle concentration for the selected size range (cumulative or differential).

There are no complicated sub-menus, no long manuals to refer to for basic information. Ued by itself, this hand held **ParticleScan Pro** allows one to quickly verify cleanrooms particle concentration, test efficiency of fliters for leakage or track down airborne particle sources. The software allows for continuous data logging in six different size ranges simultaneously. The software and memory capability transforms the unit into a powerful analysis and reporting tool. It can plot airborne particle contamination trends and size distribution in easy to read graphs. The **ParticleScan Pro** also incorporates an alarm function. When a set particle concentration is exceeded, the instrument will sound an audible alarm or set off a computer triggered alarm to allow for remedial action.

This battery driven system comes with a hard cover, briefcase like, carrying case, a purge filter for zero count calibration, an AC power Adapter-230V or 115V, software, serial-port/USB cable, and isokenetic smpling probe.

Specifications

Minimum sensitivity: 0.3 µm (counting efficiency: 50% @0.3 µm, 100% @ 0.45 µm)

Flow rate: 0.1 CFM (2.83 liters per minute)

Coincidence loss: less than 5% @ 2,000,000 particles/ per cu. ft.

Size channels (µm): 0.3, 0.5, 0.7, 1.0, 3.0, 5.0 µm

Sample time: Six (6) second, continuous, no delay time

Count displayed as: particles per cubic foot, particles per cubic meter

Display: Eight (8) digit LED

Laser source: Laser diode, 680nm

Audible alarm range: 1 – 99,999,999 particles per channel

Power: AC Adapter, 230V, 50Hz or 115V 60Hz

Batteries: 2 x 9V rechargeable included, 2 hours continuous operation

Dimensions: 7.75 x 4.0 x 2.25 inches

Weight: 1.2 lbs (0.55kg)

Warranty: One (1) year on parts and labor

Computer interface: RS 232 / USB

Data acquisition: Windows based software allows for data longing into Excel and on-line real-time data monitoring and graph display.

System Requirements: IBM compatible w/ Windows capability, available in 9 pin or 25 pin COM port, Windows 98+ and Excel 97+.

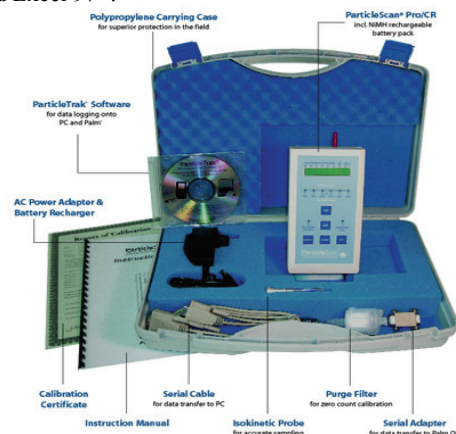



Medical Air Solutions, LLC

Engineering & Technology

Marietta GA 30068 • (800) 645-1059 • FAX (770) 977-9964

Pass-through Module for Pharmacy Applications

This 304 stainless steel pass-through module is specifically designed to interface directly with our Varitech aluminum interlocked framed cleanroom vinyl wall panels, although the pass-through can be easily installed on conventional walls as well. This pass-through was designed for the pharmacy requiring discreet material handling in compounding areas (CSP).

VTPT300



The picture shown at right shows the half clear wall with a pass-thru attached. These pass-throughs are designed to securely mount on the wall as shown. The 18"W x 18"D x 16"H module has clear polycarbonate dual interlocking doors. The rest of the construction is stainless steel. Custom sized modules are also available to meet specific requirements at reasonable prices.

Air tight gasketing around the pass-through box finishes off the attractive professional appearance of the installation.

Medical Air Solutions specializes in constructing pharmacy compounding ISO-7 cleanrooms. We manufacturer and supply the medical-grade motor/blower ceiling flush mounted 99.99%

HEPA units for positive pressure laminar flow.

Our room pressure monitor keeps constant track of the positive pressure ± 0.0001 WC. We supply both the N-6 active air sampler for biologic sampling / testing as well as a laser particle counter to measure $0.05\mu\text{m}$ particles to meet the USP <797> requirements. We provide the powder coated cleanroom gasketed ceiling panels to meet the ISO-7 requirements. We have partnered with specialized contractors around the country who know the intricacies of this type of cleanroom installation. Or we can work with your local contractor of choice.

TotalAirSecurity™

An **American** designed and manufactured product
 "AirSecurity" is a trademark of Medical Air Solutions



Medical Air Solutions, LLC

Active Air Sampler

Marietta GA 30068 • (800) 645-1059 • FAX (770) 977-9964

Single Stage Viable Impactor

The single stage, microbial impactor is specifically designed by NIOSH researchers to meet the specifications of the latest ACGIH Bioaerosol Committee concerning sampling protocol. EPA, OSHA and FDA reference Cascade Impactors in their particle sizing protocols. This unit performed identically to the N6 microbial impactor in extensive side-by-side comparison studies. This inertial impactor obtains a sharp cut-off diameter of 0.65 μm .

Product Detail

The Active air sampler is comprised of an aluminum inlet cone, jet stage, and a solid base plate held together by three spring clamps and sealed with O-ring gaskets. The jet stage has 400 precision machined jet orifices. This Single Stage Viable Impactor requires a flow rate of exactly 28.3 lpm (1 CFM) to achieve the well documented cut-off diameter of 0.65 μm .

Microbial Sampling Applications

- » Indoor air quality studies
- » Pharmaceutical production
- » Animal care laboratories
- » Wastewater treatment plants
- » Cosmetic manufacturing
- » Filter and clean room efficiency studies
- » Brewery fermentation
- » Food processing area
- » Hospital environments
- » Grain processing and transportation
- » Agricultural emissions



A6 Single Stage Viable Impactor

The single stage microbial impactor kit: includes the single stage (A6) microbial impactor, factory calibrated 115 volt oil-less rotary vane pump/ motor with handle and built-in switch, attached clear acrylic, graduated flow meter (0-30 LPM), aluminum tripod stand with 3 extending rods, carrying case, 6 feet of vinyl tubing, instructions, and inspection report

Height: 2.9" (7.4 cm)

Diameter: 4.13" (10.5 cm)

Net Weight: 1.40 lbs. (0.64 kg)

Vacuum Pump Dimensions: 9.0" (22.9 cm)L x 3.7" (9.4 cm)W x 6.0" (15.2 cm)H

Vacuum Pump Weight: 9.5 lbs. (4.3 kg)

Vacuum Pump Calibration: Calibrated for operation at 28.3 lpm (1 CFM) by primary standard calibration device (dry gas meter)

Carrying Case Dimensions: 23" (58 cm)W x 10.5" (26.7 cm)H x 11" (28 cm)D

Carrying Case Weight: 5.0 lbs. (2.3 kg)