

OPERATION & INSTALLATION MANUAL

BAPTISTRY HEATER AND CONTROL SYSTEM (240V ONLY, 4 WIRE)

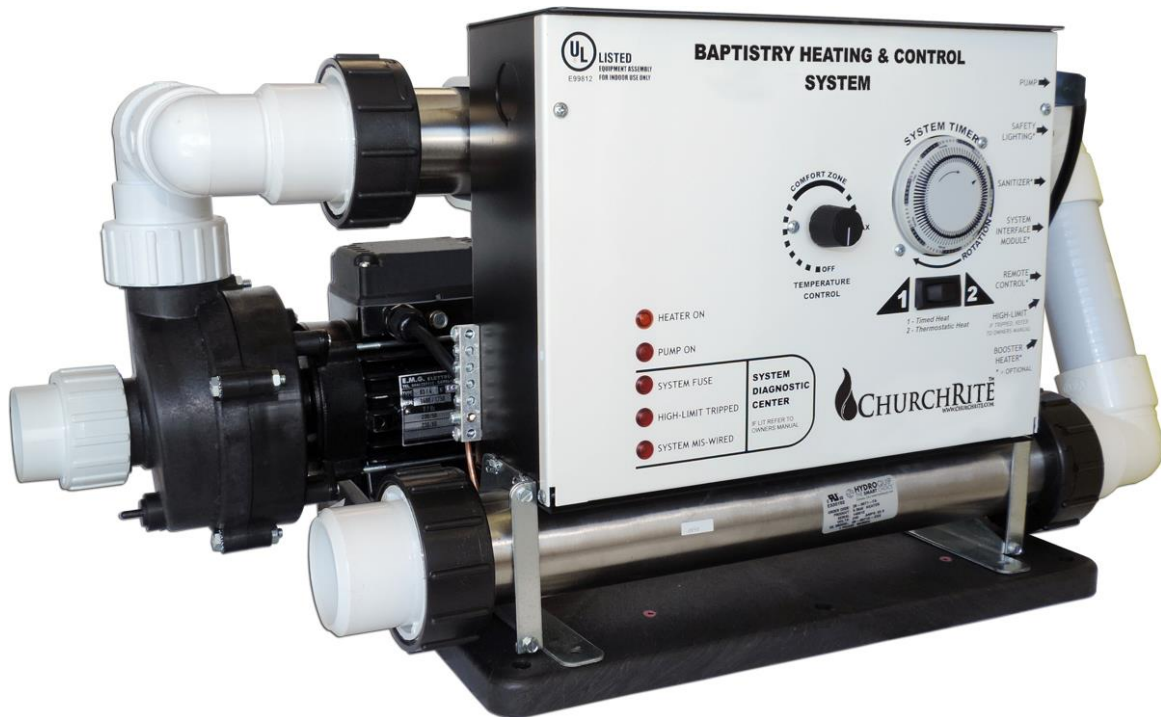

BES6005T 11KW Shown Above

BES6000 & BES6000T SERIES 5.5KW

BES6005 & BES6005T SERIES 11.0KW

 **CHURCHRITE**TM
WWW.CHURCHRITE.COM

TABLE OF CONTENTS

FITTINGS INCLUDED	2
IMPORTANT SAFETY INSTRUCTIONS	3
PRODUCT FEATURES	6
INSTALLATION/OPERATING CONSIDERATIONS	7
ELECTRICAL INSTALLATION	7
COMPONENT CONNECTIONS	10
SYSTEM INTERFACE MODULE	11
PLUMBING TIPS	12
HOLE DRILLING DIAGRAM	13
PRESSURE SWITCH PLUMBING DIAGRAM	14
EQUIPMENT DESCRIPTION	15
START UP	16
OPERATION	18
PROBLEM SOLVING	21
SYSTEM DATA LABEL / WARRANTY	22

HYDROQUIP CONTROL/HEATER ASSEMBLIES & OPTIONS COVERED IN THIS MANUAL

	HQ PART NUMBER	DESCRIPTION
CONTROL SYSTEMS	BES-6005	11KW HEATER SYSTEM
	BES-6000	5.5KW HEATER SYSTEM
	BES-6005T	11KW HEATER SYSTEM W/TIMER
	BES-6000T	5.5KW HEATER SYSTEM W/TIMER
KITS	48-0140F-K	WATER FILL/LEVEL KIT (FLOAT)
	48-0140P-K	WATER FILL/LEVEL KIT (PSI SWITCH)
	48-0141-K	DRAIN CONTROL KIT
	34-0038D25-D	REMOTE CONTROL KIT
ASSEMBLIES	48-0141C-K	WATER LEVEL ASSY. (FLOAT)
	48-0148-K	WATER LEVEL ASSY. (PSI SWITCH)
	48-0143-K	WATER FILL ASSY.
	48-0042-K	SYSTEM INTERFACE MODULE

FITTINGS INCLUDED

Compatible With BES 5.5KW & 11KW Models



2 Suction Fittings
P/N 42-0004



1 Return Fitting
P/N 42-0004



1 Overflow Fitting
P/N 42-0074A



1 Drain Fitting
P/N 42-0074A



1 Heater Tailpiece
P/N 42-0017
2" Ridged Gasket
P/N 60-0015



1 Pump Union
w/O-ring
P/N 42-0005



2 Ball Valves, 1.5"
P/N 40-0008

BES 5.5KW Models Only



1 Pump Header (5.5KW)
w/Gasket & O-ring
P/N 48-0088

BES 11KW Models Only



1 Heater to Heater (11KW)
w/ (2) Gaskets
P/N 48-0029A



1 Pump to Heater
Header (11kW)
w/Gasket & O-ring
P/N 48-0088A

IMPORTANT SAFETY INSTRUCTIONS

WHEN INSTALLING AND USING THIS EQUIPMENT, BASIC SAFETY PRECAUTIONS SHOULD ALWAYS BE FOLLOWED, INCLUDING THE FOLLOWING:

READ AND FOLLOW ALL INSTRUCTIONS

INSTALLATION CONSIDERATIONS

1. A bonding lug has been provided on the outside of the equipment system electrical controls box. This lug permits the connection of a No. 8 AWG solid copper bonding conductor between the equipment system and all other electrical equipment and exposed metal in the vicinity, as may be needed to comply with local regulations.
2. The equipment system must be installed to provide adequate drainage, and to prevent water from entering the electrical equipment area. When installing the equipment system indoors, the floors and structures beneath the installation area must be protected against water run off.
3. The electrical supply for permanently connected equipment systems that do not have an internal disconnect must include a suitably rated switch or circuit breaker to open all ungrounded supply conductors to comply with section 422-20 of the (NEC) National electric code, ANSI/NFPA 70-1987. The disconnect means must be readily accessible to the tub occupant but at least 5 feet (1.5m) from the tub water. The electrical supply for permanently connected equipment systems must also include a suitably rated ground fault circuit interrupter (GFCI) to comply with article 680-42 of the national electric code, ANSI/NFPA 70.
4. **DANGER - RISK OF ELECTRIC SHOCK.** Do not permit any electrical such as a light, telephone, radio, or television, within 5 feet of the tub.
5. **DANGER** - to reduce the risk of injury, do not permit children to use this product unless closely supervised at all times.
6. **WARNING - RISK OF CHILD DROWNING.** Exercise extreme caution to prevent unauthorized access by children. To avoid accidents, ensure that children cannot use the tub unless they are closely supervised at all times.

7. **WARNING - TO REDUCE THE RISK OF INJURY**

- A. The water in a tub should never exceed 100F (38C). Before entering the tub the user should measure the water temperature with an accurate thermometer, since the tolerance of water temperature-regulating devices may vary as much as +/- 5F (3C). A water temperatures of 100F (38C) is considered safe for a healthy adult. Lower water temperatures are recommended for extended use (exceeding 10-15 minutes) and for young children.
- B. Since excessive water temperatures have a high potential for causing fetal damage during the early months of pregnancy, pregnant or possibly pregnant women should limit tub water temperatures to 100F (38C).
- C. The use of alcohol, drugs, or medication before or during tub use may lead to unconsciousness with the possibility of drowning.
- D. Persons suffering from obesity or with a medical history of heart disease, low or high blood pressure should consult a physician before using a hot tub.
- E. Persons using medication should consult a physician before using a hot tub since some medication may induce drowsiness while other medication may affect heart rate, blood pressure, and circulation.
- F. Because occasional users of the tub may not be aware of all of the potential risks associated with tub usage, they should be made aware of these important safety features.
- G. The very young, or aged, those with illness, heart conditions or under doctor's care should not use the tub unattended. Infants should not be permitted in water temperatures more than 100F.
- H. Prolonged immersion in water that is warmer than normal body temperature can result in a dangerous condition known as HYPERTHERMIA. The causes, symptoms, and effects of hyperthermia may be described as follows: hyperthermia occurs when the internal temperature of the body reaches a level several degrees above the normal body temperature of 98.6F. The symptoms of hyperthermia include dizziness, fainting, drowsiness, lethargy, and an increase in the internal body temperature. The effects of hyperthermia include: (1) unawareness of impending hazard, (2) failure to perceive heat, (3) failure to recognize the need to exit the hot tub, (4) physical inability to exit the hot tub, (5) fetal damage in pregnant women, and (6) unconsciousness resulting in a danger of drowning.
WARNING: the use of alcohol, drugs, or medication can greatly increase the risk of fatal hyperthermia.

8. **DANGER** - to reduce the risk of injury to persons in the tub, never remove, or alter in any way, the grates or covers on the suction fittings in the tub. Never operate the equipment system if the grates or covers on the suction fittings are broken or missing.

The water should always flow freely from the hydrotherapy jets within the tub. Any blockage or restriction of water flow by persons or objects may damage the system components, create an electrical shock hazard, and/or cause water damage to the surrounding area. To avoid damage to the pump and heater, the equipment system must never be operated unless the tub is filled with water to the operating level.

9. **WARNING** - the equipment system may be equipped with a ground fault circuit interrupter (GFCI), mounted on the electrical control box. This GFCI protects against electrical shock hazard by sensing electrical fault conditions and interrupting the electric power applied to the equipment system.

Before each use of the tub the GFCI, if provided, should be tested in the following manner: Turn electric power on, Push the test button. The reset button should pop outward, indicating that the GFCI is functioning properly. Push the reset button all the way in, restoring electrical power to the equipment system. If the reset button does not pop outward when the test button is pushed, a loss of GFCI protection is indicated. Should this occur, immediately disconnect electrical power from the equipment system, and discontinue use of the tub until a qualified technician has identified and corrected the problem.

10. **DANGER** - risk of electrical shock. Install at least 5 feet (1.5m) from all metal surfaces. A tub may be installed within 5 feet of metal surfaces if each metal surface is permanently connected by a solid copper conductor attached to the wire connector on the control box that is provided for this purpose. A pressure wire connector is provided on the control box to permit connection of a minimum No. 8 AWG (8.4mm) solid copper bonding conductor. The bonding conductor should not be smaller the service conductors supplying the equipment. Connect this point to any metal enclosures of electrical equipment, metal water pipes, or conduit within 5 feet (1.5m) of the unit as needed to comply with local requirements.

SAVE THESE INSTRUCTIONS

PRODUCT FEATURES

1. **GROUND FAULT CIRCUIT INTERRUPTER** – This device is required for portable tubs as specified in the national electrical code article 680. The GFCI is designed to protect against potential electrical shock hazard should a ground fault occur.

Note: Equipment mounted GFCI discontinued as of June 14, 2014

2. **THERMOSTAT** - The thermostat regulates the water temperature of your tub.
3. **TIME CLOCK (Optional)** - Provides timer control over heating and filtering cycles
4. **PUMP RECEPTACLE** – Connect pump here.
5. **POWER AIR SWITCH** – Turns the system on and off
6. **SAFETY LIGHT CIRCUIT** – 120V hot output for 12V light kit (PT# 37-0029-SM)
7. **SANITIZER CIRCUIT** – Provides a 240V output when pump is running for a water sanitizer
8. **HIGH LIMIT** - A safety switch that will shut the heater off if the temperature within the heater reaches a non-adjustable limit.
9. **SYSTEM INTERFACE MODULE RECEPTACLE** – Provides Auto-Fill and Auto-Drain function. Auto-Fill Control (PT# 48-0042-K)
10. **REMOTE CONTROL RECEPTACLE:** Provide remote thermostat control over the system.
11. **HEATER ASSEMBLY** - Thermostatically controlled and equipped with a high-limit safety shut off.
12. **ROCKER SWITCH** - Determines operation of the time clock.
13. **PLUMBING HEADER ASSEMBLY** – Connects the pump to the heater (Plumbing for BES6000/T Systems may appear different).
14. **PLUMBING HEADER ASSEMBLY** – Connects the bottom heater to the top heater (BES6005/T Systems Only).
15. **BOOSTER HEATER** – Additional 5.5KW Heater Assembly Included with the BES6005/T Systems Only.
16. **PUMP ASSEMBLY** – Circulates water from and to the baptistry. (**Not self priming**)
17. **BASE** – ABS base for mounting equipment

Figure 1.0

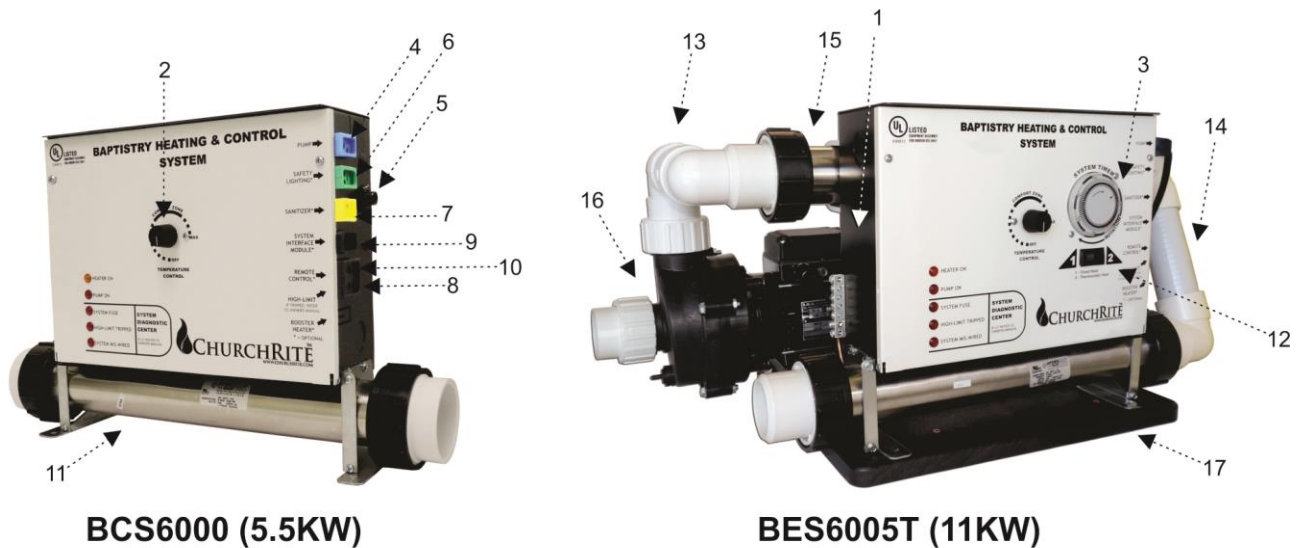

INSTALLATION AND OPERATING CONSIDERATIONS

The equipment control system must be protected from the elements by installing it indoors or in a weather-tight enclosure.

The equipment should be installed so that there is safe and adequate access for servicing and routine maintenance procedures.

The single-speed circulation pump included with this system is **NOT** a self-priming pump and must be installed below water level for proper operation.

Connections between the tub and equipment control system should include shut off valves for servicing and only non-metallic pipe should be used.

Connections between the tub and equipment should be done with schedule 40 and/or flexible PVC.

If any thread sealer compounds are to be used, they must be compatible with PVC and ABS plastics.

Equipment room or enclosure must have adequate ventilation.

Note: Operation of your tub during the warm months of the year may cause the temperatures to rise inside the equipment compartment. Due to the extensive insulation of some models it may cause the pumps thermal protection device to automatically turn the pump off for a short period of time (15-30 minutes) to allow the pump to cool down before automatically restarting. This cool down feature will not harm your system but serves to protect the pump from damage. This condition can also be caused by low voltage or by high altitudes where the air necessary for cooling is much thinner.

ELECTRICAL INSTALLATION

A qualified electrician must make all electrical connections to the equipment control box in accordance with the National Electrical Code and in accordance with any local electrical codes in effect at the time of installation. All electrical connections must be made in accordance with the wiring information contained in this manual, or on the back of the field wiring access panel of the equipment control box.

The electrical supply for permanently connected equipment controls must also include a suitably rated ground fault circuit interrupter (GFCI) to comply with article 680-42 of the National Electrical Code, ANSI/NFPA 70.

The equipment may be designed to operate at 240 volts, 60hz. Connections must be made using copper conductors only. Field provided conductors and circuit breakers or fuses must be sized to accommodate the total amperage load of the equipment.

WARNING - Improper electrical connections or conductor sizing will create the potential for an electrical hazard, and may void the warranty.

<u>Model</u>	<u>Heater Voltage</u>	<u>Heater Watts</u>	<u>Breaker Size</u>	<u>Wire</u>
BES-6005/T	240 V	11.0 kW	60A	4
BES-6000/T	240 V	5.5 kW	40A	4

CAUTION: Use only approved pressure-type wire splicing or connectors suitable for the size and type of wiring used.

The electrical supply for this product must include a suitably rated switch or circuit breaker to open all ungrounded supply conductors to comply with section 422-20 of the National Electrical Code, ANSI/NFPA 70. The disconnecting device must be within sight, and readily accessible to the user of the tub, but installed at least 5 feet (1.5m) from the tub. Connect a # 8 AWG (8.4mm) solid copper bonding conductor between the equipment control box bonding lug and all other electrical equipment and exposed metal in the vicinity, as may be needed to comply with local regulation.

240 VOLT INSTALLATION - Permanently Connected Units

1. Remove the faceplate from the control box to allow access to the input wiring.
2. Connect input wiring to the terminal block as shown below. A GFCI protected three wire electrical service plus ground is required for a 240-volt connection (line 1, line 2, neutral, and ground). Failure to connect a neutral line will cause the control box to malfunction and may void the warranty.
3. Reinstall the control box faceplate.

BES6000/6000T

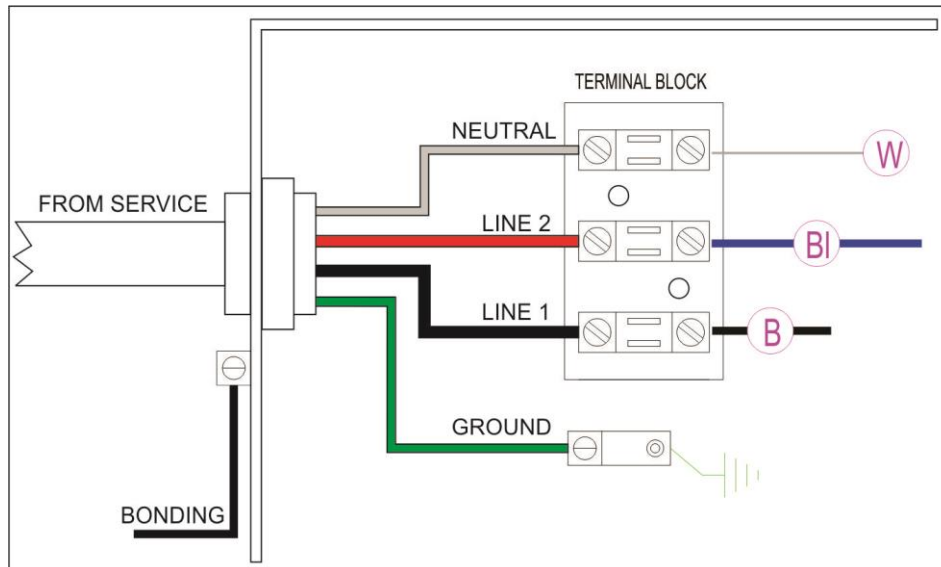

BES6005/6005T

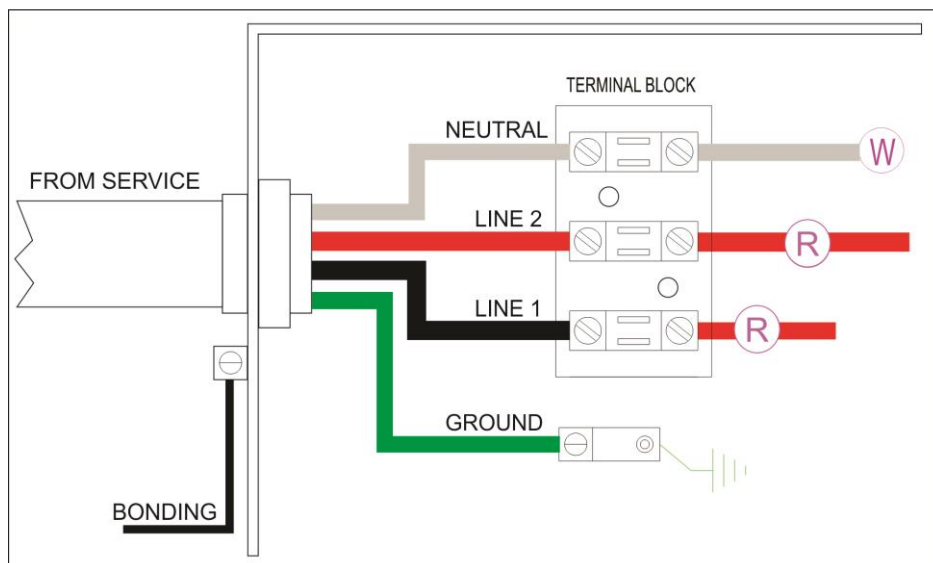

BES OPTIONAL COMPONENT CONNECTIONS

BES BAPTISTRY CONTROL

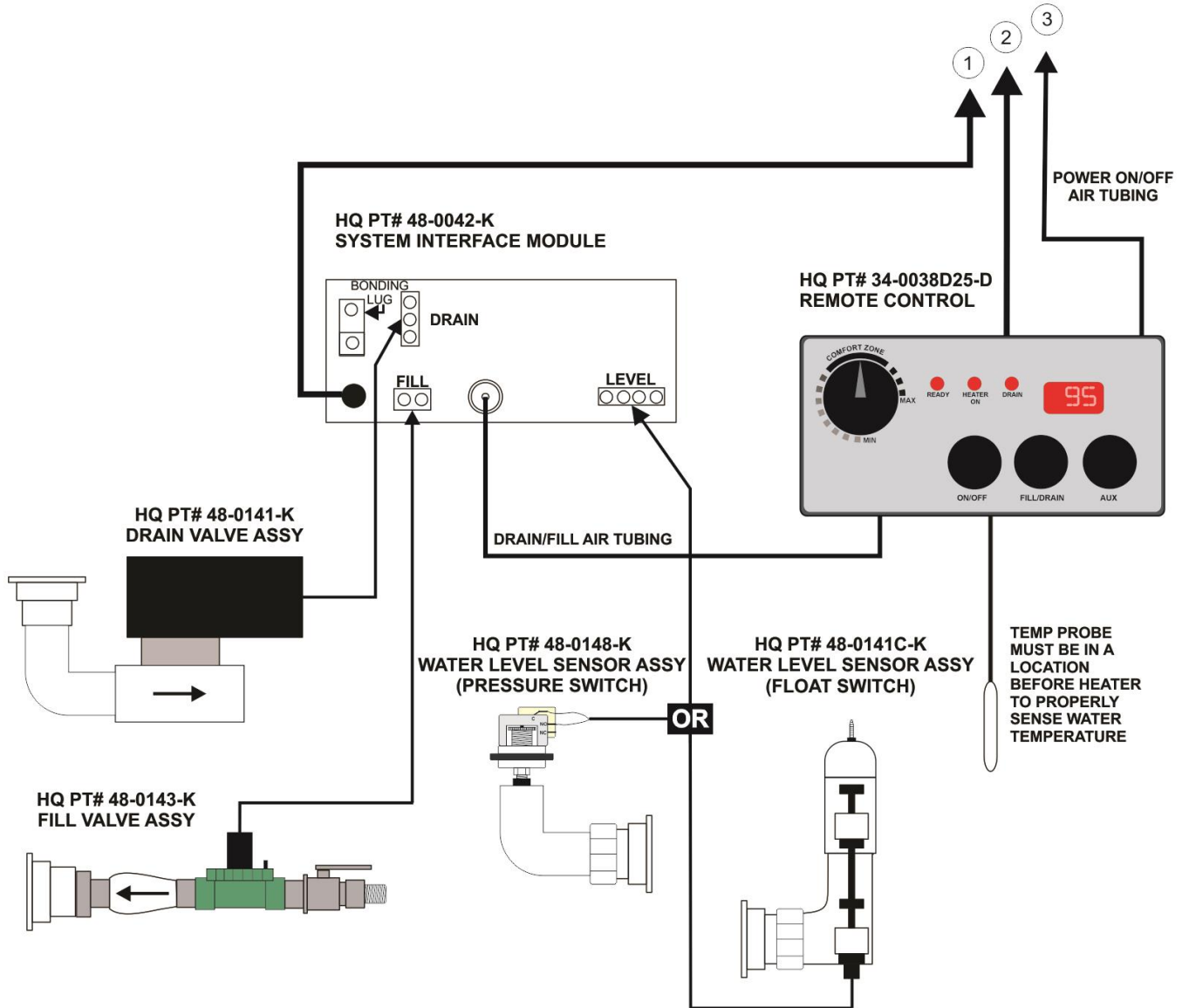
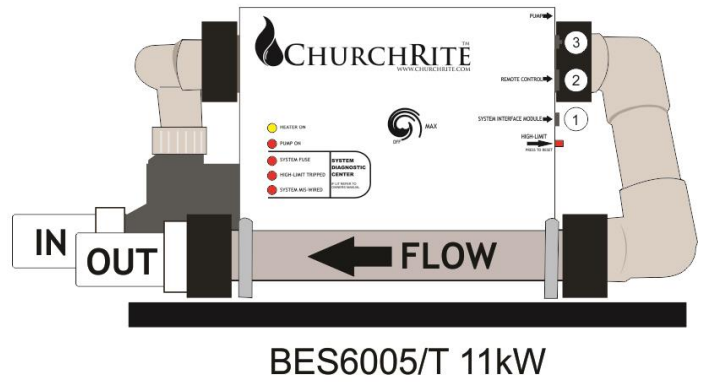
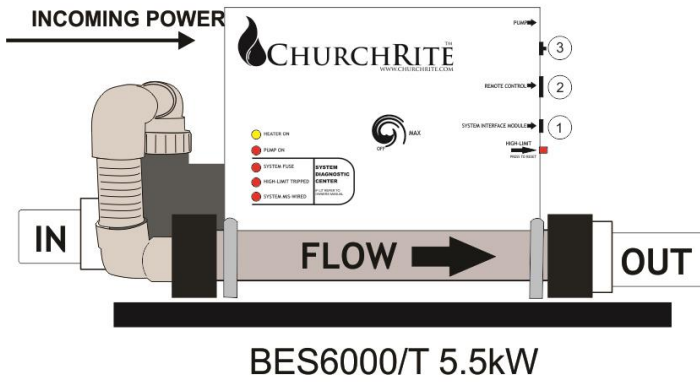

SYSTEM INTERFACE MODULE

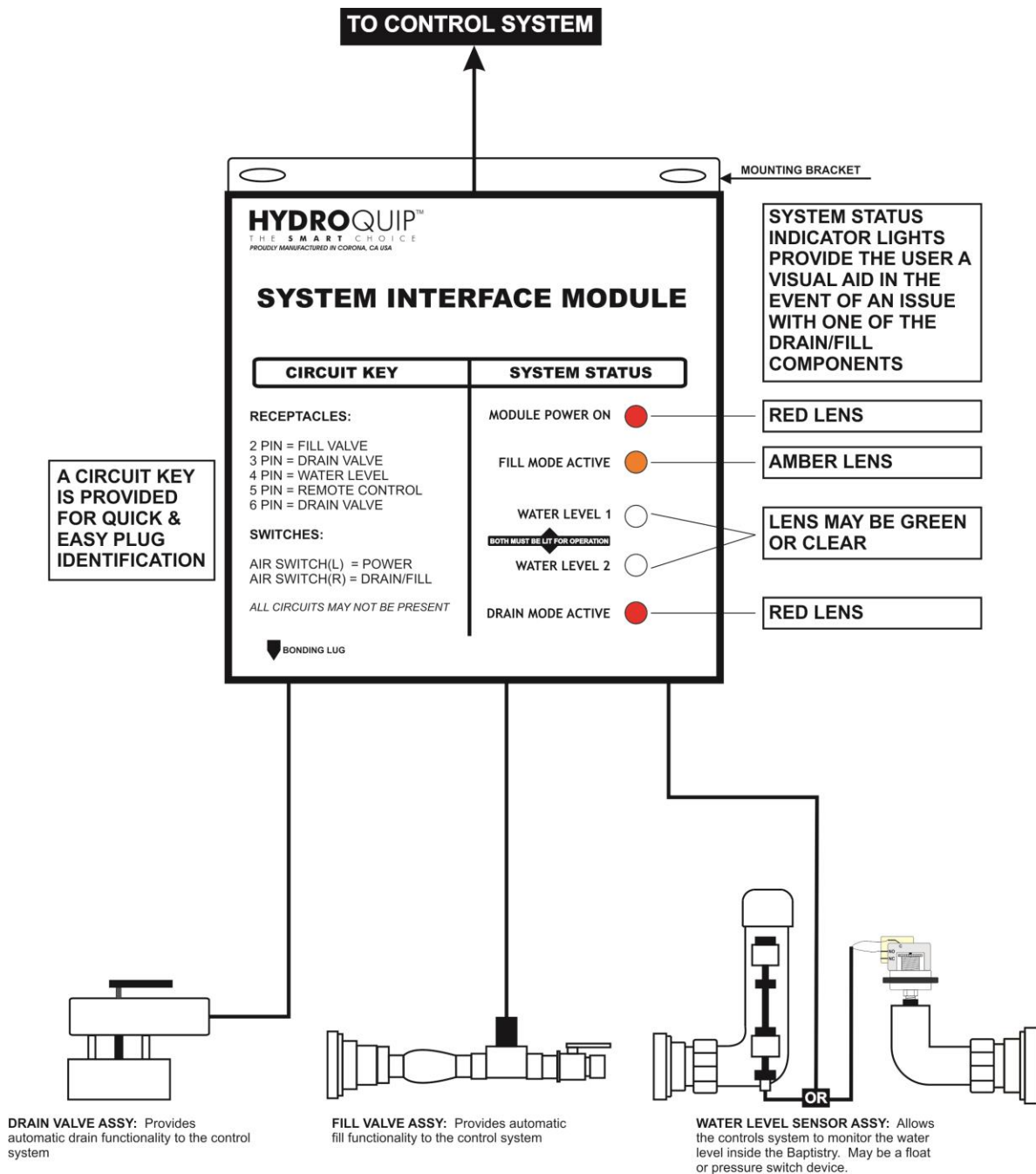

SEE PAGE 12 FOR IMPORTANT TIPS

PLUMBING AND AUTO-FILL TIPS

PLUMBING TIPS:

- MEASURE TWICE DRILL ONCE
- DRY-FIT PLUMBING BEFORE HOLES ARE DRILLED
- SCHEDULE 40 AND/OR FLEXIBLE PVC SHOULD BE USED BETWEEN EQUIPMENT AND BAPTISTRY
- ALWAYS USE COMPATIBLE ADHESIVES AND PRIMERS

NOTE: IF ANY THREAD SEALER COMPOUNDS ARE TO BE USED, THEY MUST BE COMPATIBLE WITH PVC AND ABS PLASTICS.

AUTO-FILL VALVE TIPS:

- INSTALL PER PLUMBING DIAGRAM
- VALVE ASSY CAN BE AFFECTED BY WEIGHT, SUPPORT IF NECESSARY
- FILL ASSY CAN BE PLUMBED VERTICALLY OR HORIZONTALLY
- TO BYPASS FILL VALVE LOOSEN SMALL BLACK SCREW NEXT TO SOLENOID

AUTO-DRAIN VALVE TIPS:

- IF SYSTEM IS DRAINING AND FILLING AT THE SAME TIME FLIP TOGGLE SWITCH ON DRAIN VALVE TO OPPOSITE POSITION
- DO NOT ATTEMPT TO TURN VALVE BY HAND, PERMANENT DAMAGE WILL OCCUR.

BALL VALVE INSTALLATION / TIPS

- BALL VALVES HAVE BEEN PROVIDED FOR CONVENIENCE SHOULD SERVICE NEED TO BE PERFORMED.
- INSTALL (1) VALVE BEFORE AND (1) VALVE AFTER THE CONTROL SYSTEM AS SHOWN ON PAGE 14.

HOLE DRILLING DIAGRAM

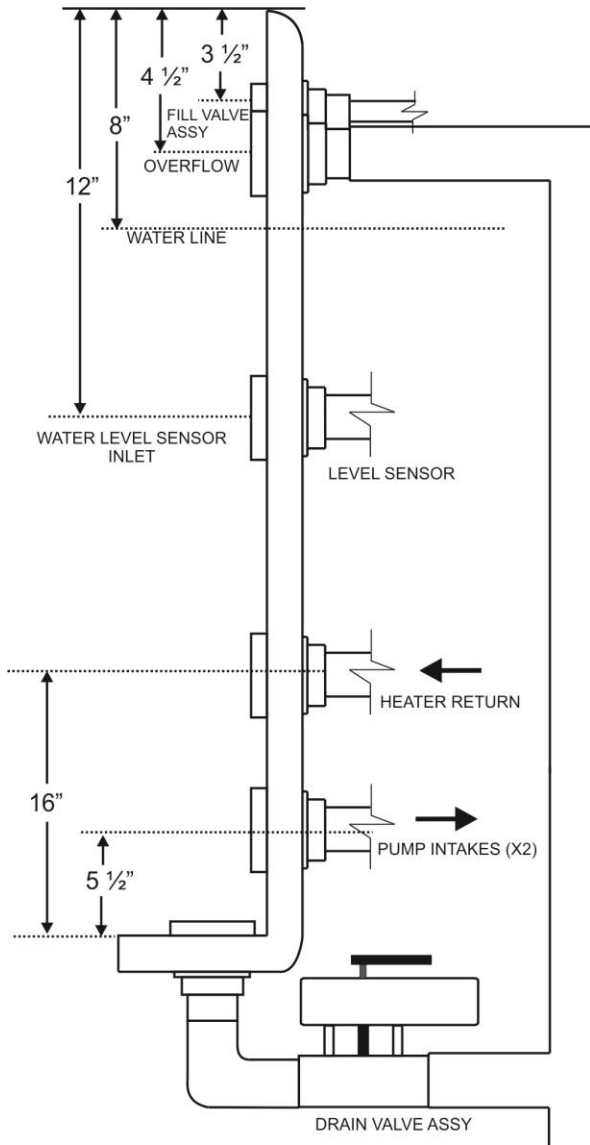

HOLE SIZE CHART

FITTING	PART NUMBER	HOLE SIZE
PUMP INTAKE	42-0004	2 3/8"
HEATER DISCHARGE	42-0004	2 3/8"
OVERFLOW	42-0074A	2 3/8"
WATER LEVEL SENSOR	42-0074A	2 3/8"
FILL VALVE ASSY	42-0074	2 3/8"

HOLE LEGEND

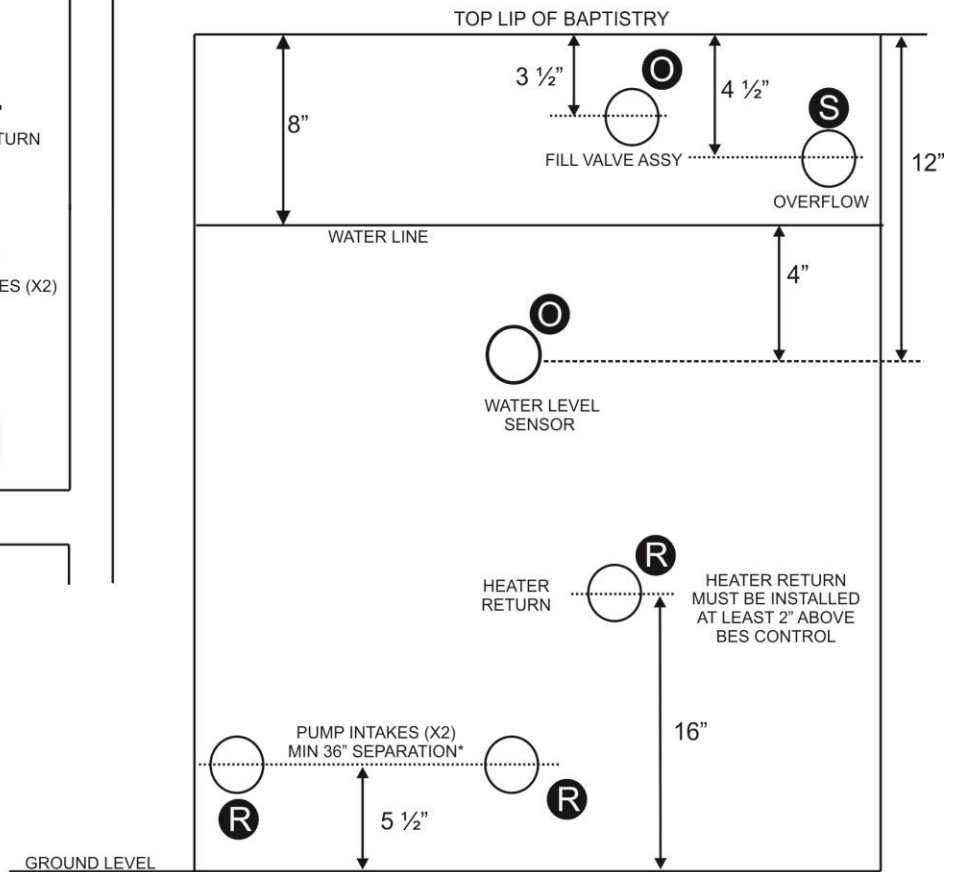
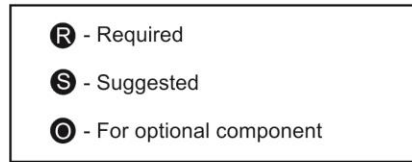

*TO COMPLY WITH AMSE/ANSI A112.19.8M-1987, ASME A112.19.8-2007

Note: Sealing compounds must be compatible with PVC and ABS plastics

ALL OPTIONS SHOWN FOR BES6000 SYSTEM

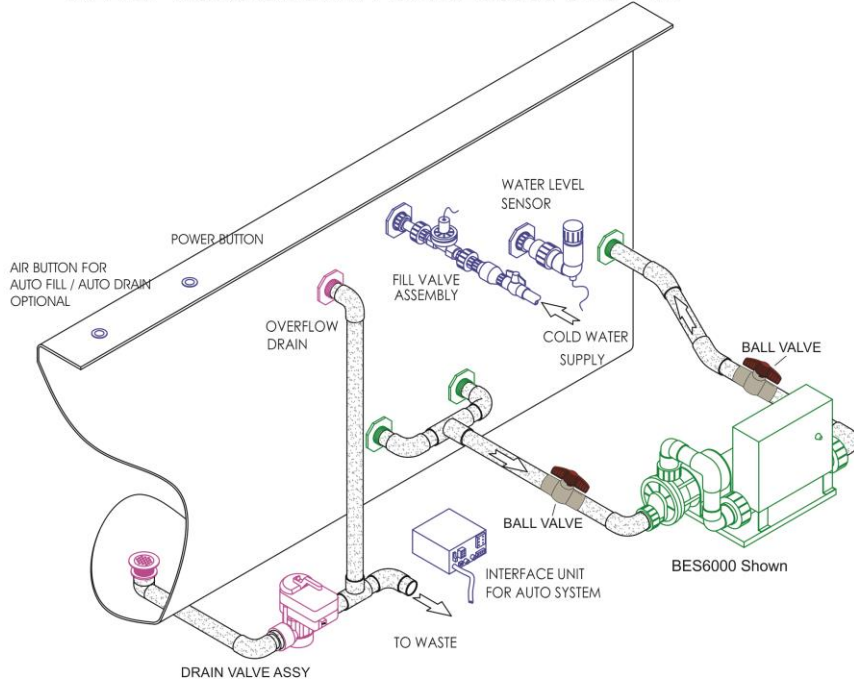

ALL OPTIONS SHOWN FOR BES6005 SYSTEM

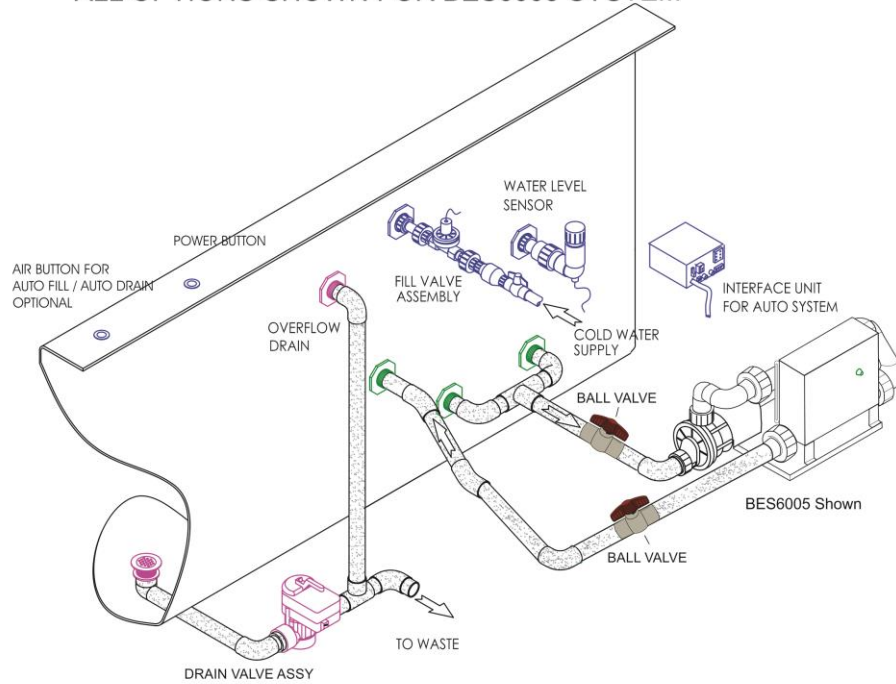

Note: These drawings and information are for general presentation purposes only. The drawings are not intended as a diagram for installation.

Note: Sealing compounds must be compatible with PVC and ABS plastics

EQUIPMENT DESCRIPTION

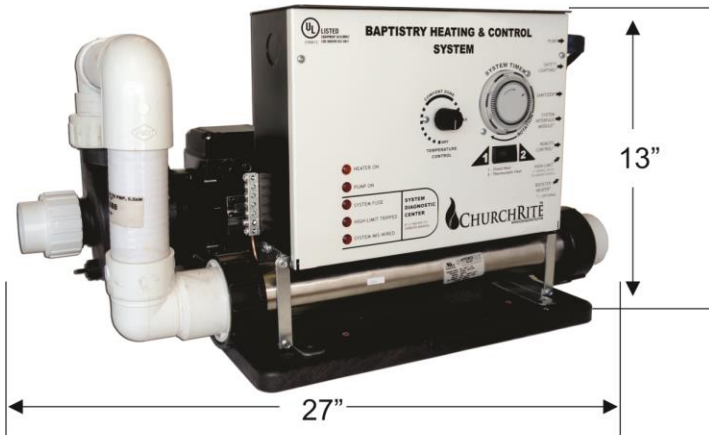

BES6000/T (5.5kW)

WIDTH = 27"
HEIGHT = 13"
DEPTH = 15"

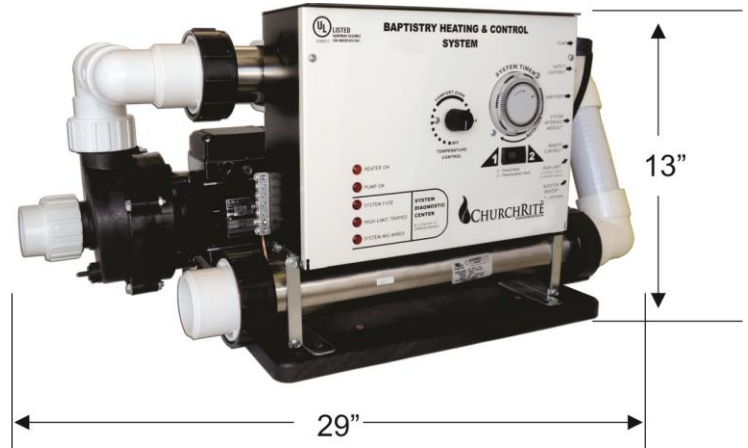

BES6005/T (11kW)

WIDTH = 29"
HEIGHT = 13"
DEPTH = 15"

CONTROL BOX

The control box contains all the electrical components necessary to operate your tub, it also contains the field wiring compartment. The System Interface Module (DRAIN/FILL CONTROL) Control plugs into the receptacle on the side of the control box.

GROUND FAULT CIRCUIT INTERRUPTER (GFCI)

Note: Equipment mounted GFCI discontinued as of June 14, 2014

The GFCI is designed to provide protection against potential electrical shock hazard should a ground fault occur.

The installation of a properly sized ground circuit and bonding circuit is still required as detailed in the electrical installation section of this manual. The GFCI in your installation may be installed at the electrical service panel, a separate sub panel, or built into the control box.

Test the GFCI before each use and at least monthly when the tub is not being used regularly.

Test the GFCI as follows:

1. With the power on, push the test button; the lever should trip to center position.

Caution - If the GFCI fails to operate in this manner, do not use the tub until a qualified service technician has corrected the problem.

1. To restore power, flip lever to the OFF position and back to ON.

THERMOSTAT

Setting the thermostat controls the temperature of the water. The thermostat is located on the front of the control box.

When the equipment is operating, the thermostat will control the heater. Initially, adjust the thermostat knob to the middle of the "Comfort Zone." This setting will cause the water temperature to rise to approximately 80F (27C). Do not expect to feel hot water coming from the return fitting.

The length of time it takes the water to reach desired temperature depends on several factors: water temperature at start, ambient air temperature, tub capacity, relative humidity, type and insulating qualities of a cover and the consistency of electric power applied.

Any graduations on the scale around the thermostat are intended for reference only. They do not reflect the actual water temperature. Remember that a small change on the dial will yield a difference of several degrees, so make small adjustments until you find your preferred temperature. Allow several hours between adjustments for temperatures to stabilize. Use an accurate thermometer to monitor the water temperature.

HIGH LIMIT

The purpose of this switch is to shut off the heater if the water temperature within the heater reaches a factory-set, non-adjustable limit. After the water cools sufficiently, push to reset. If the switch trips repeatedly, do not use the tub until the problem has been identified and corrected by a qualified service technician.

HEATER

The stainless steel housing contains an electrical heating element and is fitted with a safety pressure switch that monitors water flow.

The heater operates on demand at the power levels indicated in the table below. It will shut off when the thermostat setting is reached or the water ceases to flow.

SELECTION GUIDE FOR ELECTRIC HEATERS

Use this table to select the proper size Electric Heater for spas, hot tubs, and other vessels of water. This table is based on "Temp Rise per Hour" and assumes the vessel will be covered while heating. If the vessel is located outside in cold weather an increase in heater size may be required.

Kilowatt AMPs Voltage	1.0KW 8.3A 120V	2.0KW 8.3A 240V	4.0KW 16.6A 240V	5.5KW 22.9A 240V	8.0KW 33.3A 240V	11.0KW 45.8A 240V
Water Volume Gallons	TEMPERATURE RISE IN 1 HOUR (F)					
100	4.11	8.22	16.44	22.61	32.88	45.21
200	2.06	4.11	8.22	11.30	16.44	22.61
300	1.37	2.74	5.48	7.54	10.96	15.07
400	1.03	2.06	4.11	5.65	8.22	11.30
500	0.82	1.64	3.29	4.52	6.58	9.04
600	0.69	1.37	2.74	3.77	5.48	7.54
700	0.59	1.17	2.35	3.23	4.70	6.46
800	0.51	1.03	2.06	2.83	4.11	5.65
900	0.46	0.91	1.83	2.51	3.65	5.02
1000	0.41	0.82	1.64	2.26	3.29	4.52

TEMPERATURE RISE FORMULA

$$T = \frac{kW \times 411}{V}$$

V = Volume of water in Gallons
kW = Kilowatt of Heater
T = Temperature Rise per Hour in F°

8/10 - MBS

SYSTEM INTERFACE & MODULE

Provides functionality of Auto-Fill & Auto-Drain option(s) and components when module is installed.

SYSTEM DIAGNOSTIC CENTER

These indicators provide real time diagnostics of the system.

- **HEATER “ON”** – Illuminated whenever the heater is activated
- **PUMP “ON”** – Illuminated whenever the system pump is activated.
- **SYSTEM FUSE** – Illuminated when the main system fuse is blown
 - Possible indication of pump issue.
- **HIGH LIMIT TRIPPED** – Illuminated when the High-Limit safety switch is tripped
 - If the switch trips repeatedly do not use until corrective service is performed
- **SYSTEM MIS-WIRE** – Illuminated when the system has been mis-wired
 - This is an indication the 120V has been sent up the Neutral line and is a protective feature. Have an electrician correct the issue to allow operation.

TIME CLOCK (IF EQUIPPED)

7 DAY TIMECLOCK

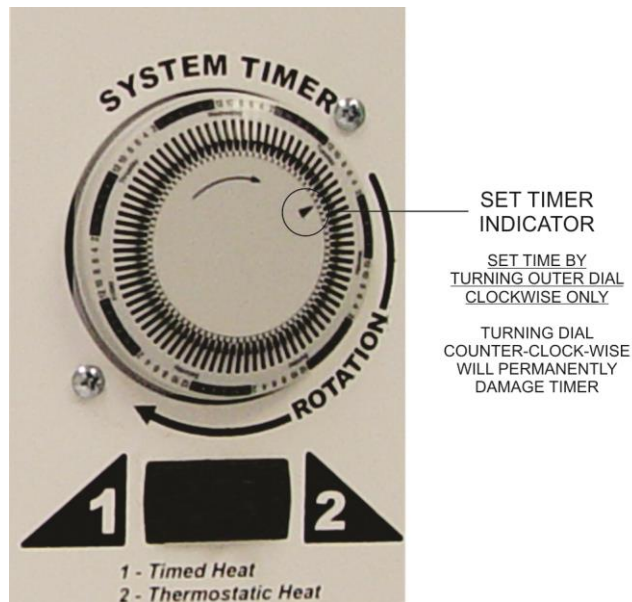

Provides timer control over heating and filtration cycles. To activate a timed cycle push the teeth on the timer outward, each tooth represents 2 hours of operation. The (2) modes of operation are based on the rocker switch under the timer and are as follows:

1. **Timed Heat Mode:** The system heats and filters based on the setting of the timer
2. **Thermostatic Heat Mode:** The pump comes on and off with relation to the thermostat. If a timed cycle occurs outside a heat call the pump will activate to provide additional filtration.

SYSTEM START-UP

1. Open all water valves, if equipped, on the inlet and/or outlet to allow water to flow into the equipment system.

CAUTION: The equipment system must never be operated without water or serious damage to the heater and/or pump may result which can void the warranty.

Note: If the control box is equipped with a ground fault circuit interrupter, it may be necessary to press and release the red GFCI Reset button.

IMPORTANT NOTE: It is most important that the pump be operated for several minutes to insure that all air has been removed from the system before the heater is allowed to operate. Only after full water flow has been established should the thermostat be turned up.

START UP OPERATION

Operating considerations for BES standalone (option A):

1. For initial start up turn thermostat all the way down and fill tub. Install air tubing and air button to the Power Air Switch nipple.
2. Insure that tub has water above highest return and loosen the union on the front of the pump to bleed air from the system.
3. Turn on system power, the pump should activate and water should begin flowing. If not, press Power Air Switch button once. Allow pump to run until all air is purged from the unit
4. Turn the thermostat UP, the heat light on the front of the BES unit should illuminate.
5. Insure pressure switch is properly adjusted to allow heat function (Indicator will light for heat).
6. Before draining insure that power has been removed from the control.

Operating considerations for BES with Auto Fill (option B):

1. Insure that SYSTEM INTERFACE MODULE (DRAIN/FILL CONTROL) option control is securely plugged into BES receptacle. Install one set of air tubing and air button to the Power Air Switch nipple on the control system and one set to the Fill/Drain air switch nipple on the Interface Module.
2. Set thermostat all the way down and apply power to unit. If the Module Power ON light does not illuminate, press the Power Air Switch button once. If fill valve does not open and begin filling the tub then press the fill/drain air button one time.
3. Once the unit is full, the fill valve will automatically close, the pump will engage and the unit should be ready for heating once air is purged from the system.
4. Turn the thermostat UP until the heat engages and set for desired temperature (pressure switch may require some adjustment). The pump will continue to run as long as tub is full and power is applied.
5. Before draining unit insure that the auto fill has been deselected (press button once) or that power is removed from BES.

Operating considerations for BES with Auto Fill/Auto Drain (option C):

1. Insure that SYSTEM INTERFACE MODULE (DRAIN/FILL CONTROL) option is securely plugged into matching receptacle and that Auto-Drain valve cord is installed. Install one set of air tubing and air button to the Power Air Switch nipple on the control system and one set to the Fill/Drain air switch nipple on the Interface Module.
2. Set the thermostat all the way down and apply power to unit. If the Module Power ON light does not illuminate, press the Power Air Switch button once. The fill mode active light should be lit, if not, press the fill/drain once.

Note: The fill mode and drain mode lights may be lit at the same time while the drain motor is in motion. Please wait a few seconds for one light to turn OFF to know the current selected mode.

3. Once the tub is full the fill valve will automatically close, the pump will engage and the unit should be ready for heating once air is purged from the system.
4. Turn the thermostat UP until the heat engages and set for desired temperature (pressure switch may require some adjustment). The pump will continue to run as long as tub is full and power is applied.
5. To drain, press the Fill/Drain button once. After the unit is drained press Power air button once to insure that no inadvertent filling or draining can take place.

*****Once Fill or Drain is selected you must allow drain valve to travel completely before switching back or the actuator may stick half way requiring power to be recycled*****

Operating considerations for BES with Remote Control Auto Fill/Drain (option D):

1. Insure that SYSTEM INTERFACE MODULE (DRAIN/FILL CONTROL) option is securely plugged into BES receptacle and that Auto-Drain valve cord is installed. Install one set of air tubing and air button from Remote Control to the Power Air Switch nipple and one set to the Fill/Drain air switch nipple.
2. Insure Remote Control is plugged into receptacle for Option Control and that both thermostats on BES and Remote Control are set to minimum (fully CCW).
3. Apply power. If the Module Power ON light does not illuminate, press the Power Air Switch button once. The fill mode active light should be lit, if not, press the fill/drain button once.

Note: The fill mode and drain mode lights may be lit at the same time while the drain motor is in motion. Please wait a few seconds for one light to turn OFF to know the current selected mode.

4. The remote control display will light up once the baptistry is full. Pump will engage and the unit should be ready to heat once air is purged.
5. Turn the Remote Control thermostat clockwise until the heat light on the Remote Control engages and set dial for desired temperature (pressure switch may require adjustment). The pump will continue to run as long as tub is full and power is applied.
6. Once temp is reached the fill light will again appear, heat light will be off and the digital display will display actual temperature. Pump will continue to run.
7. To drain press Fill/Drain once. Indicators should switch from fill or heat to drain and temp display will be blank. Pump will stop.
8. Once the tub is empty press Power air button or turn off power until all indicators are off to insure no inadvertent filling or draining can take place.

*****Once Fill or Drain is selected you must allow drain valve to travel completely before switching back or the unit may stick half way requiring power to be recycled*****

Heater Pressure Switch adjustment:

After filling the spa or hot tub each time it is important that the pump be operated, with thermostat OFF, for several minutes to insure that all the air has been removed from the system before the heater is turned on. Trapped air can cause the heater to dry fire, which is not covered under the warranty.

Factory Installed Pressure Switch:

Your Baptismal System is equipped with a pressure switch. The function of the pressure switch is to shut the heater off if the pump is turned off or if there is restricted water flow (dirty filter, obstruction in the spa plumbing etc.).

Installation Below Spa Surface:

If the system is installed more than two (2) feet below the water level, adjustment of the pressure switch may be necessary. The following procedures and illustrations outline the adjustment of the pressure switch.

Follow the system start up procedures (leaving the thermostat in the OFF position). **CAUTION:** Remove all power to the unit prior to completing the steps below:

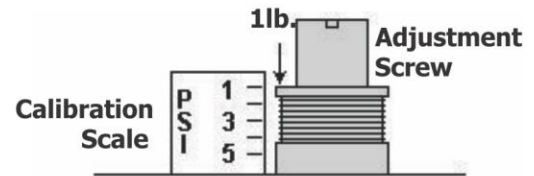
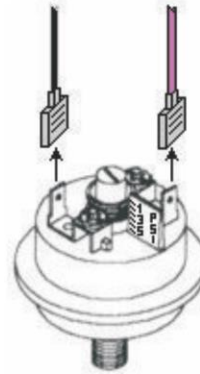
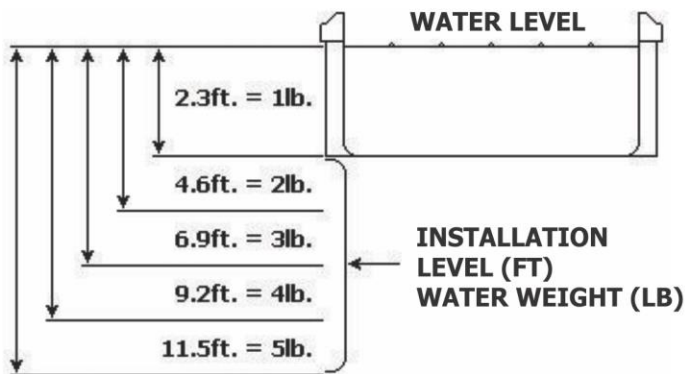

- 1) Shut off power to the Baptismal System prior to attempting any adjustments to the pressure switch.
- 2) Remove wires from pressure switch terminals.
- 3) Place an Ohm meter across the pressure switch terminals to verify an OPEN circuit. If closed proceed to step #5.
- 4) Rotate the pressure switch adjustment screw (slot) *counter-clockwise* until the Ohm meter indicates a CLOSED circuit.
- 5) Rotate the pressure switch adjustment screw *clockwise* until the Ohm meter indicates an OPEN circuit again.
- 6) Apply power to the unit at this time and operate the system as normal.

TROUBLESHOOTING

Equipment system will not operate:

1. Make sure the Power Air Switch is turned "ON"
2. Check if the Ground Fault Circuit Interrupter breaker is tripped. If tripped, attempt to reset the GFCI. If the GFCI trips repeatedly, contact a service technician to correct the problem.
3. Check the main circuit breaker panel. If the circuit breaker has tripped reset the breaker. If the circuit breaker trips repeatedly, contact a service technician to correct the problem.
4. For cord connected units check the receptacle.
5. Make sure the high-limit has not tripped. Push to reset.

Pump will run but there is no water flow:

1. Make sure system is installed below water level.
2. Make sure all valves are in the open position.
3. Make sure that the filter is clean.
4. Check the suction fittings to make sure that they are not clogged with debris.
5. Check the water level and make sure it is above the heater return and at the proper level for operation.
6. Check the pump for trapped air. With the pump off, loosen the outlet union and allow all air to escape. Re-tighten union, apply power to system and when there is water flowing to the return fitting the system should be heating if required. You may need to use a sponge to collect the water from this operation.

Pump runs and there is water flow but no heat:

1. Turn the thermostat to a higher temperature setting. Do not expect to feel hot water coming from the jets.
2. Check to see if the high limit switch reset button, located on the front of the control box, has popped outward. If so, reset by pressing inward.
3. Check to make sure that all the valves are open and that there is full flow. Limited water flow may not activate the pressure switch to allow the heater to come on.
4. Pressure switch may not be activated. Please refer to heater pressure adjustments for proper operation.
5. Heater ON light lit, but no heat. Contact your local technician for service.
6. Insufficient back pressure: Close return valve partially to increase pressure and allow heater to operate.

The water will not maintain the proper temperature:

1. A thermal cover may be required to maintain the water temperature.
2. Turn the thermostat to a higher setting.

Too much water flow / noisy pump:

1. Close discharge valve partially to reduce water flow.
3. Close discharge valve partially to reduce pump noise.

SYSTEM DATA LABEL

The system data label is located on the control box. This label is very important and contains information you will need to establish your electrical service. The voltage and amperage ratings are shown on the bottom of the label. Product, Model, Serial and Code numbers are also shown on the label.

Note: This information will be necessary if you should ever have to request warranty or any other type of service.



Limited Warranty

To all original purchasers, ChurchRite warrants its products to be free from defects in material and workmanship for a period of one year from the date of purchase.

ChurchRite will repair or replace the part, which in our opinion, is defective.

This warranty excludes damage as a result of: normal wear, freezing, low voltage, chemical abuse, accident, negligence, alteration, improper installation, use or care.

To obtain warranty service, return defective products within the warranty period to ChurchRite.

Purchaser is responsible for removal or reinstallation labor, freight charges, or any other such costs incurred in obtaining warranty service.

ChurchRite assumes no responsibility for incidental or consequential damages. Some states do not allow the exclusion of incidental or consequential damages, so the above limitations and exclusions may not apply to you. This warranty gives you specific legal rights and you may also have other rights, which vary from state to state.

THE BAPTISTRY MANUFACTURER OR DEALER MAY PROVIDE A DIFFERENT WARRANTY.

