

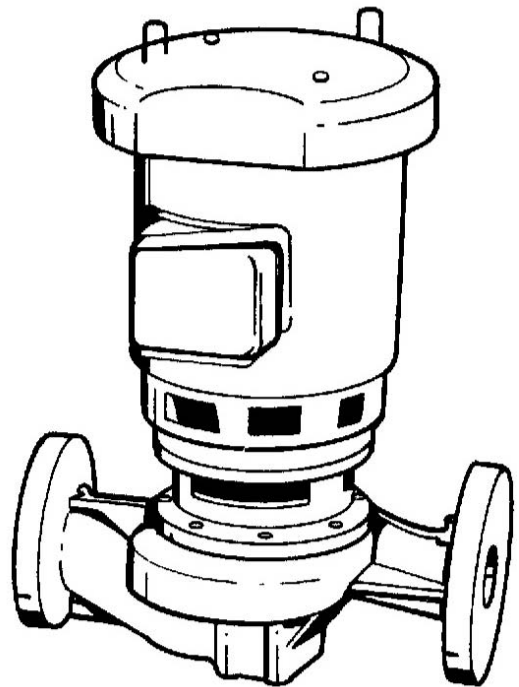

SERIES 80

IN-LINE MOUNTED CENTRIFUGAL PUMP PERFORMANCE CURVES - 60 HZ

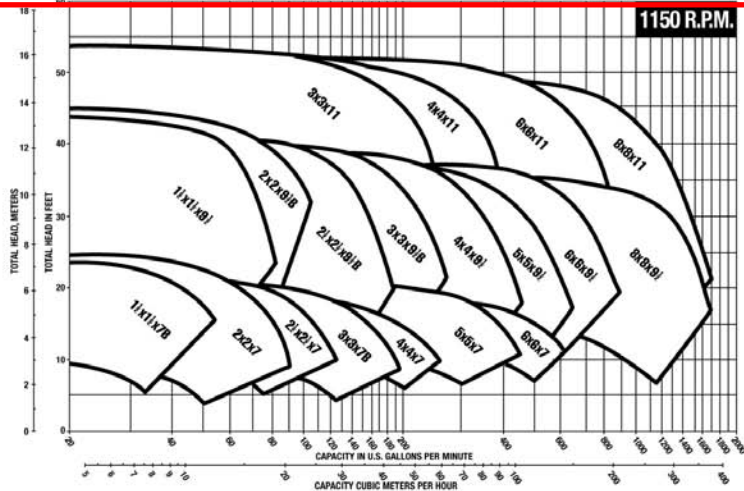
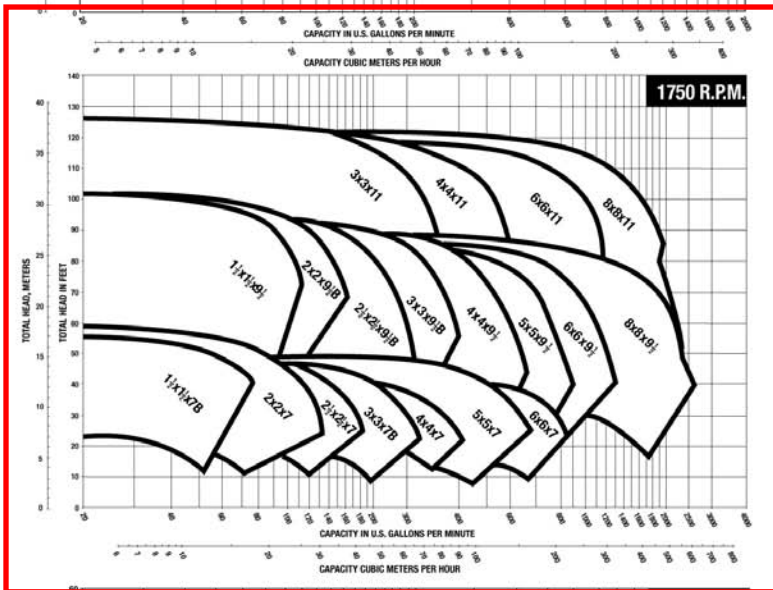
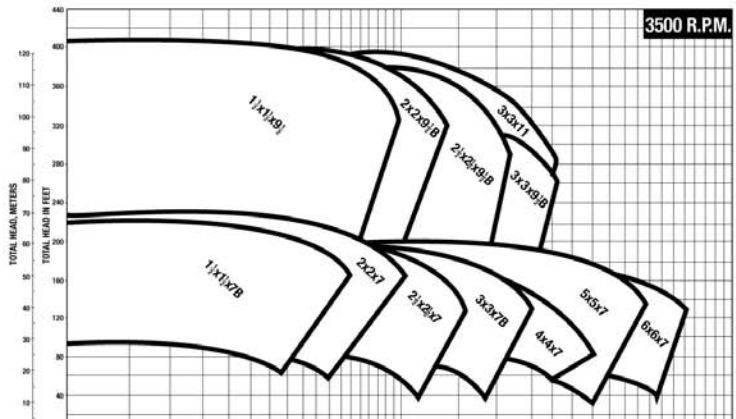

SERIES 80 STANDARD PUMPS

TABLE OF CONTENTS

| | |
|-------------------------------------|----|
| Useful Pump Formulas | 2 |
| Series 80 Standard Pumps | 3 |
| 3500 RPM PUMP CURVES | |
| 7" Maximum Impeller Diameter | 4 |
| 9½" Maximum Impeller Diameter | 7 |
| 1750 RPM PUMP CURVES | |
| 7" Maximum Impeller Diameter | 10 |
| 9½" Maximum Impeller Diameter | 13 |
| 11" Maximum Impeller Diameter | 17 |
| 1150 RPM PUMP CURVES | |
| 7" Maximum Impeller Diameter | 20 |
| 9½" Maximum Impeller Diameter | 23 |
| 11" Maximum Impeller Diameter | 27 |

USEFUL PUMP FORMULAS

$$\begin{aligned} \text{Pressure (PSI)} &= \frac{\text{Head (Feet)} \times \text{Specific Gravity}}{2.31} \\ \text{Head (Feet)} &= \frac{\text{Pressure (PSI)} \times 2.31}{\text{Specific Gravity}} \\ \text{Vacuum (Inches of Mercury)} &= \frac{\text{Dynamic Suction Lift (Feet)} \times .883}{\text{Specific Gravity}} \\ \text{Horsepower (Brake)} &= \frac{\text{GPM} \times \text{Head (Feet)} \times \text{Specific Gravity}}{3960 \times \text{Pump Efficiency}} \\ \text{Horsepower (Water)} &= \frac{\text{GPM} \times \text{Head (Feet)} \times \text{Specific Gravity}}{3960} \\ \text{Efficiency (Pump)} &= \frac{\text{Horsepower (Water)}}{\text{Horsepower (Brake)}} \times 100 \text{ Per Cent} \\ \text{NPSH (Available)} &= \text{Positive Factors} - \text{Negative Factors} \end{aligned}$$

Affinity Laws: Effect of change of speed or impeller diameter on centrifugal pumps.

| | GPM Capacity | Ft. Head | BHP |
|--------------------------|---------------------------------|--|--|
| Impeller Diameter Change | $Q_2 = \frac{D_2}{D_1} Q_1$ | $H_2 = \left(\frac{D_2}{D_1}\right)^2 H_1$ | $P_2 = \left(\frac{D_2}{D_1}\right)^3 P_1$ |
| Speed Change | $Q_2 = \frac{RPM_2}{RPM_1} Q_1$ | $H_2 = \left(\frac{RPM_2}{RPM_1}\right)^2 H_1$ | $P_2 = \left(\frac{RPM_2}{RPM_1}\right)^3 P_1$ |

Where Q = GPM, H = Head, P = BHP, D = Impeller Dia., RPM = Pump Speed

SERIES 80 STANDARD PUMPS

Designed with preselected impeller diameters and motor horsepower sizes to offer better availability.

Pump Construction: Bronze Fitted
 Standard Mechanical Seal
 Maximum Working Pressure 175 psi
 with 125# ANSI Flanges

Motors: 208-230/460 Volts
 3 Phase, 60 Hertz
 Open Dripproof

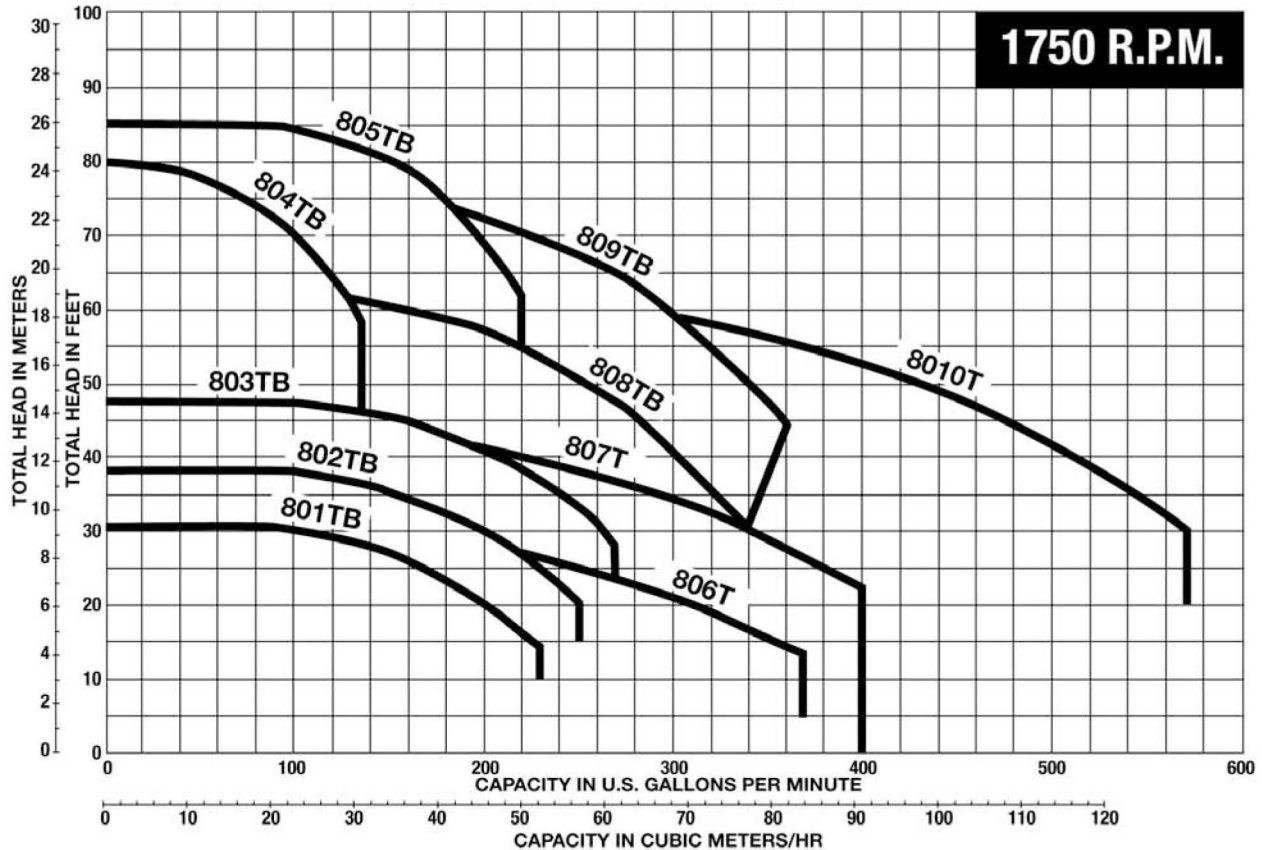

| UNIT NO. | PUMP SIZE | MOTOR HP |
|----------|---|----------|
| 801TB | 3x3x7B | 1.5 |
| 802TB | | 2 |
| 803TB | | 3 |
| 804TB | 2x2x9 ¹ / ₂ B | 5 |
| 805TB | 2 ¹ / ₂ x2 ¹ / ₂ x9 ¹ / ₂ B | |

| UNIT NO. | PUMP SIZE | MOTOR HP |
|----------|-------------------------------------|-------------------------------|
| 806T | 4x4x7 | 2 |
| 807T | | 3 |
| 808TB | 3x3x9 ¹ / ₂ B | 5 |
| 809TB | | 7 ¹ / ₂ |
| 8010T | 4x4x9 ¹ / ₂ | |

HOW TO USE THIS BOOKLET

- Determine the Pump Model number from the quick selection charts on the cover of this Booklet. Required data: Pump Flow and Head and desired RPM. Use the Standard Pumps shown on this page when possible.
- Consult the individual pump curve for the desired pump model to determine the required motor horsepower, pump efficiency and NPSHR.
- For faster, computerized pump selections, consult your Bell & Gossett Representative about ESP-PLUS, Bell & Gossett's Equipment Selection Program for personal computers.

SERIES 80 STANDARD PUMPS

3500 RPM PUMP CURVES

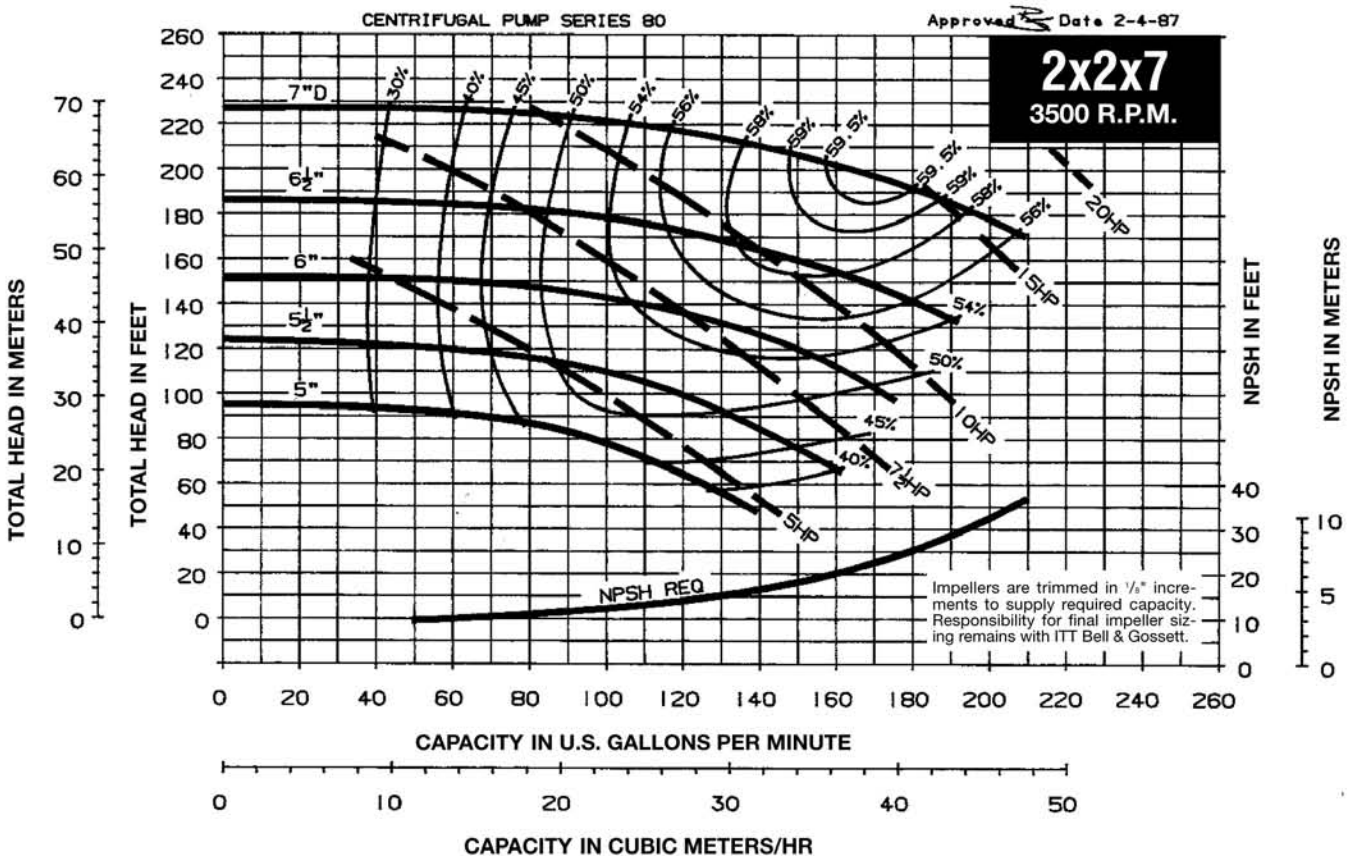
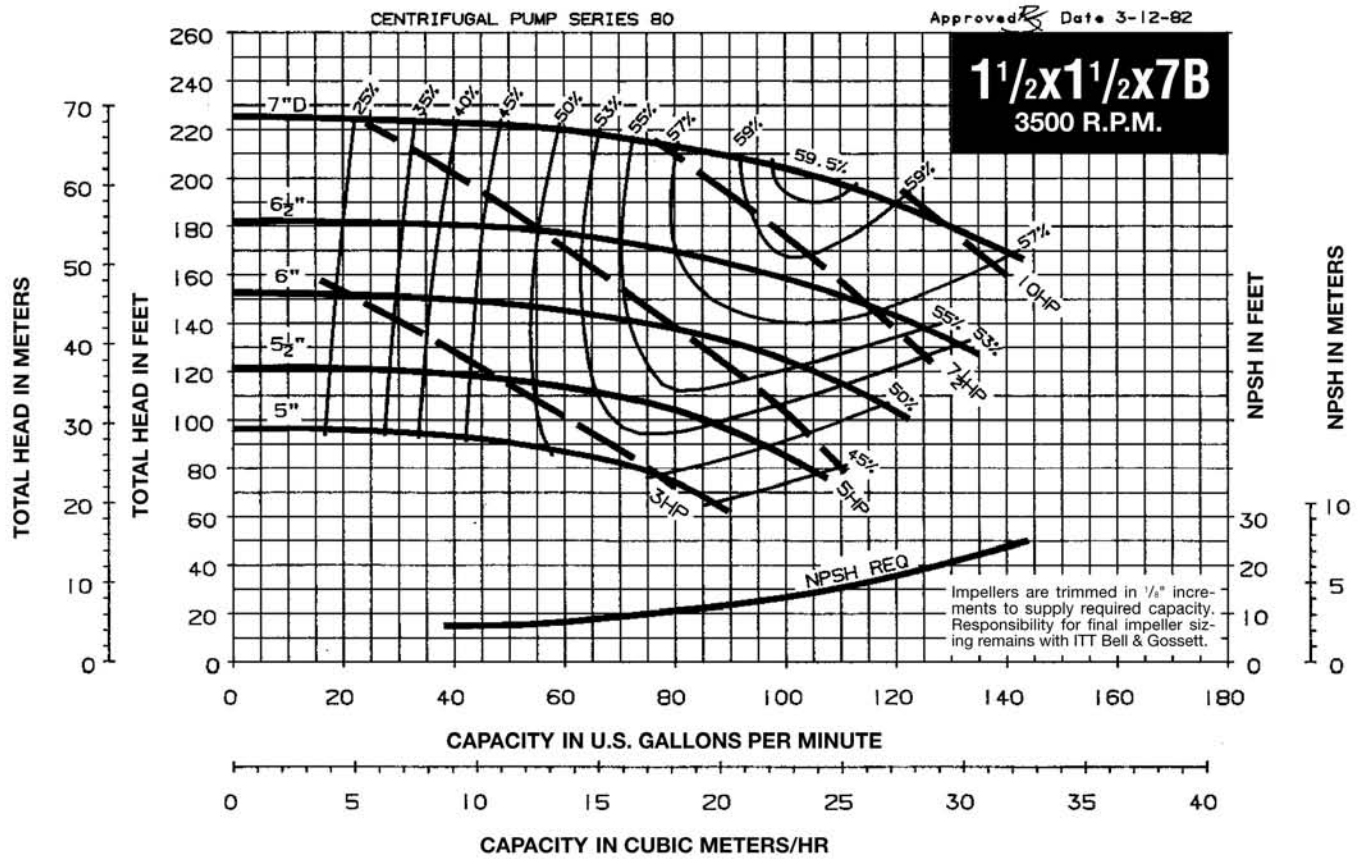

SERIES 80 STANDARD PUMPS

3500 RPM PUMP CURVES

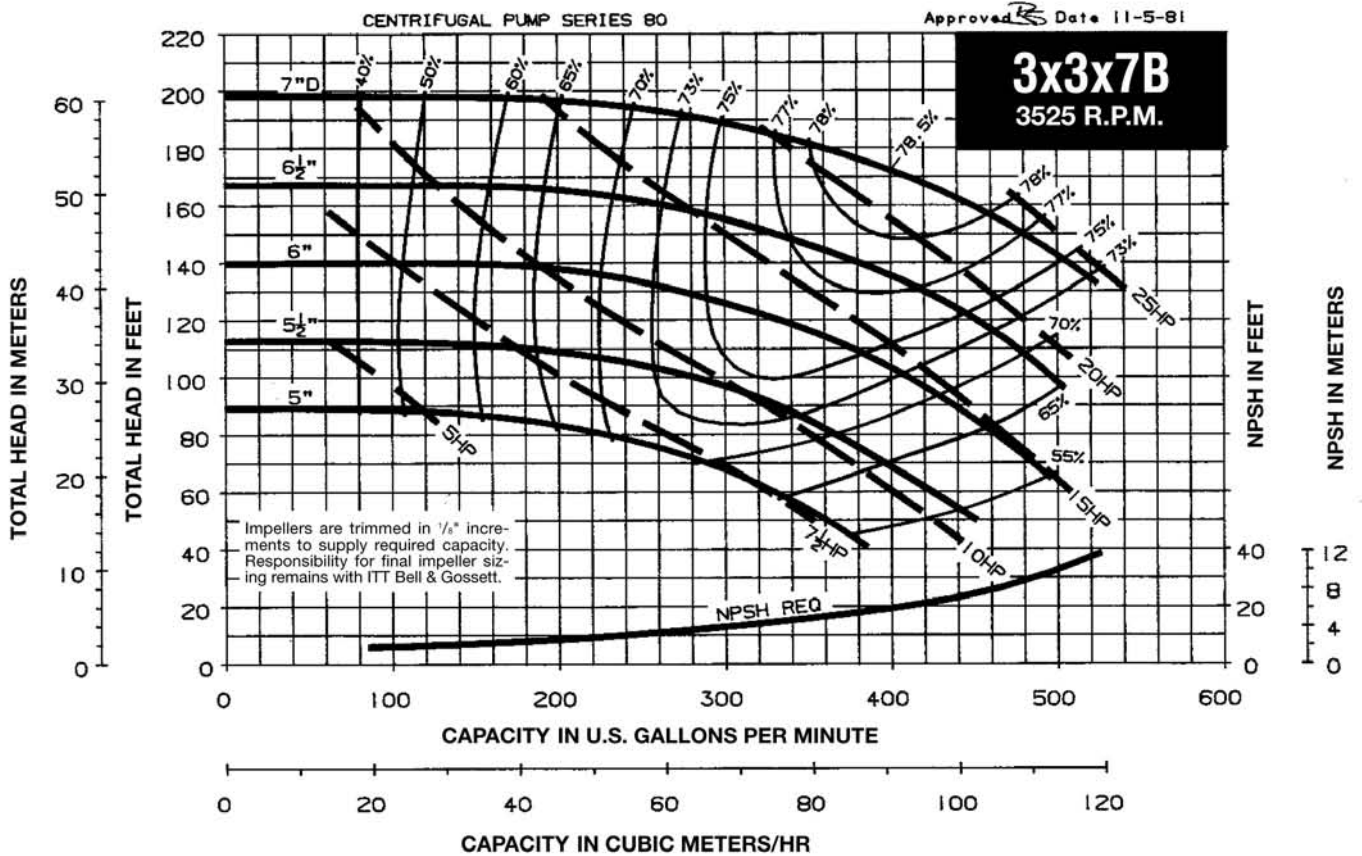
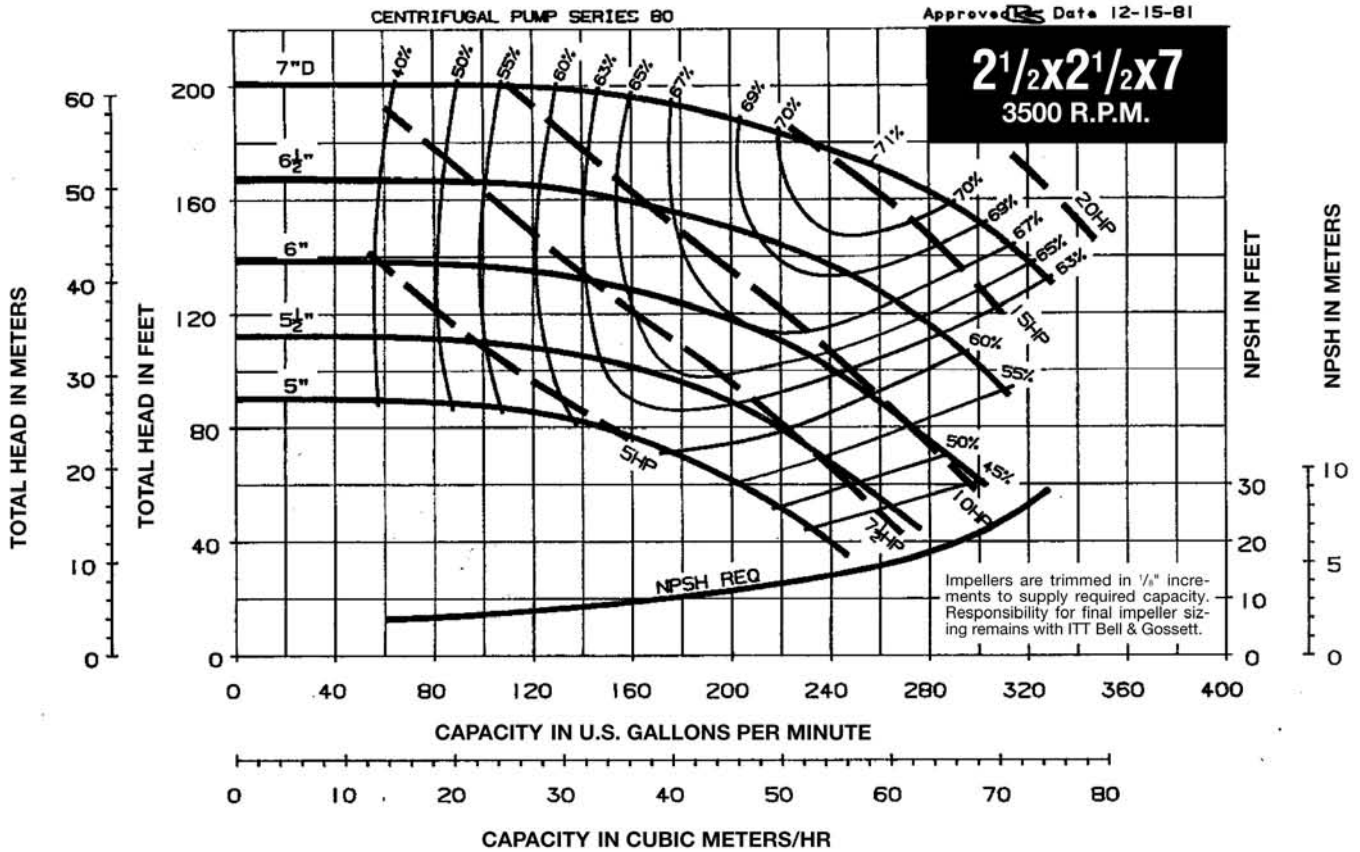

SERIES 80 STANDARD PUMPS

3500 RPM PUMP CURVES

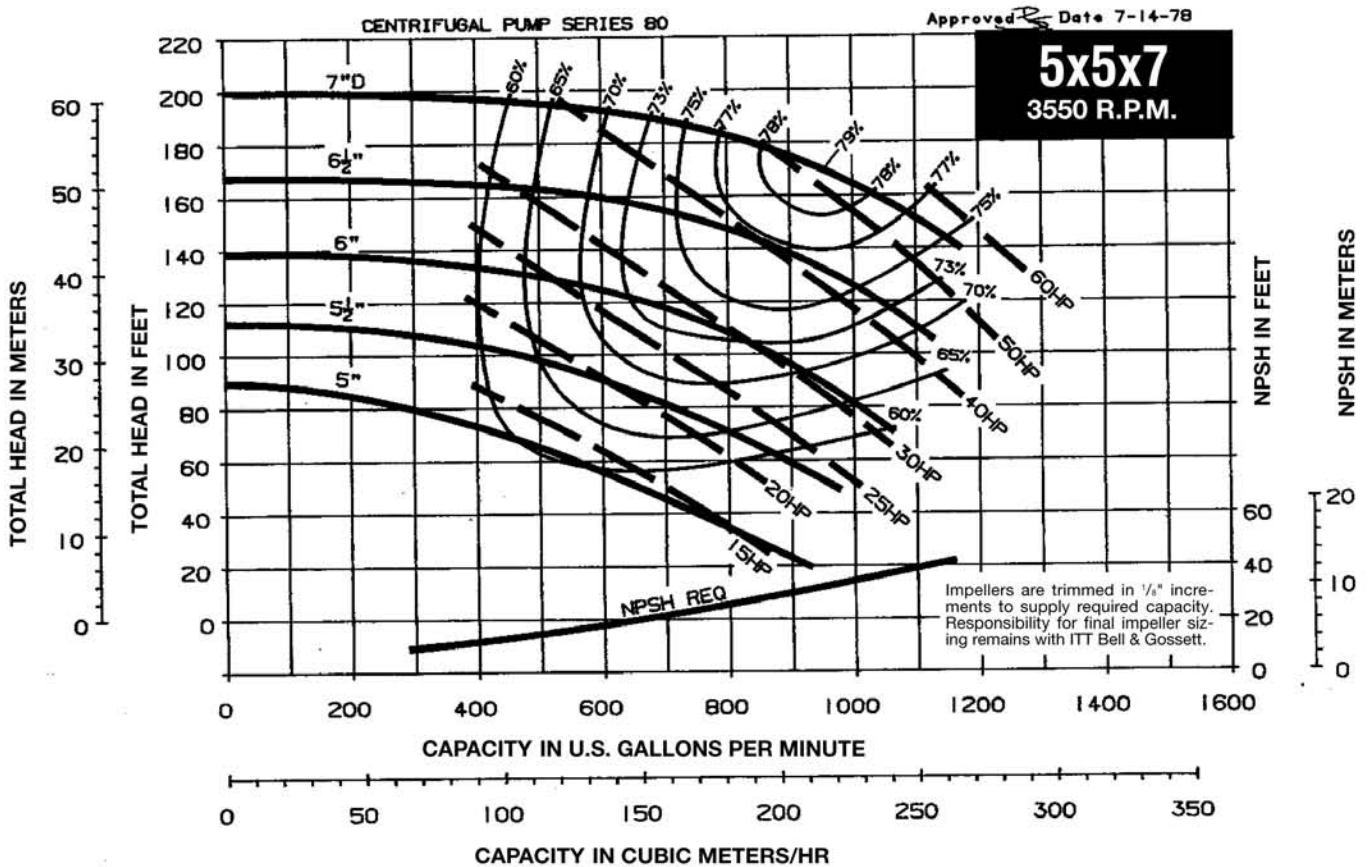
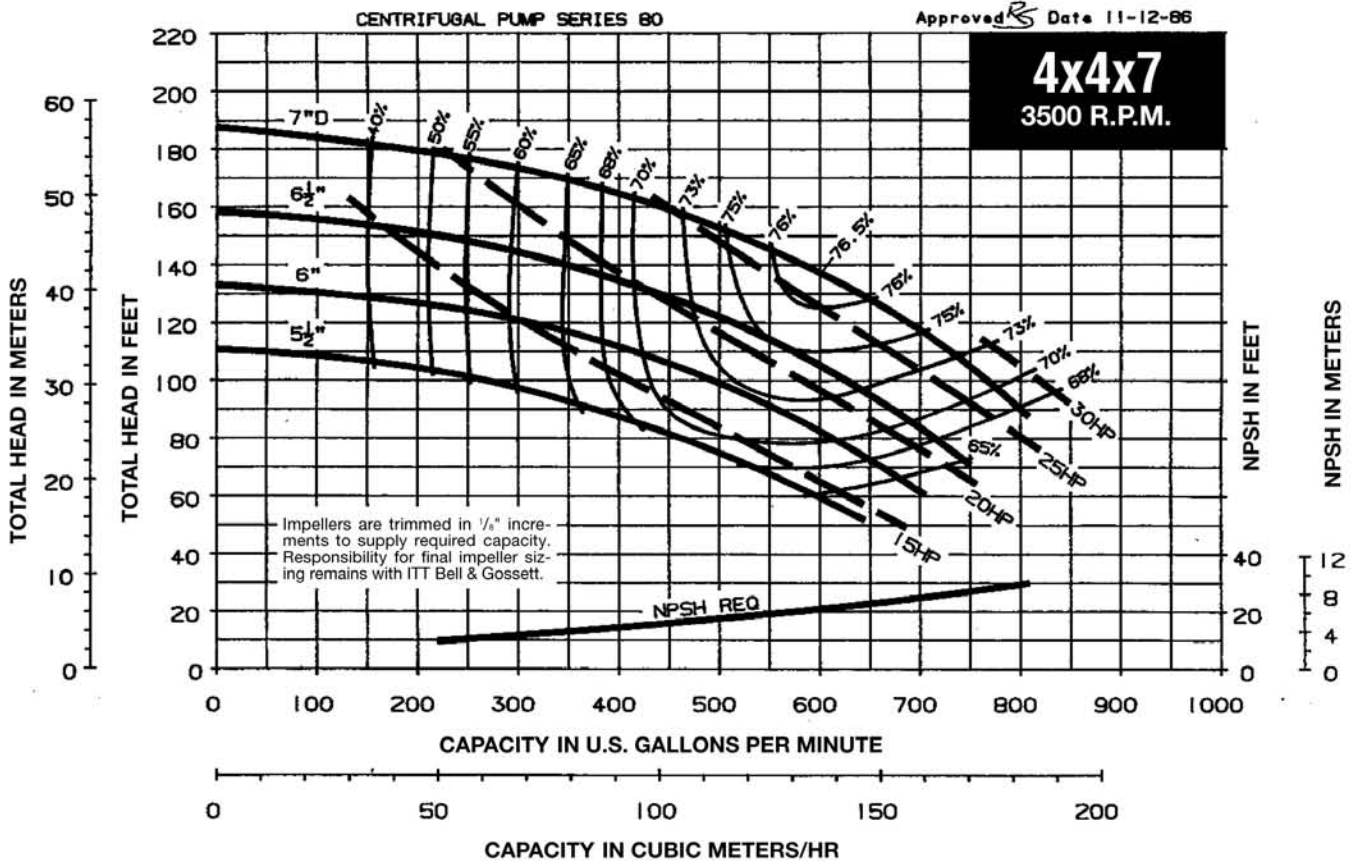

SERIES 80 STANDARD PUMPS

3500 RPM PUMP CURVES

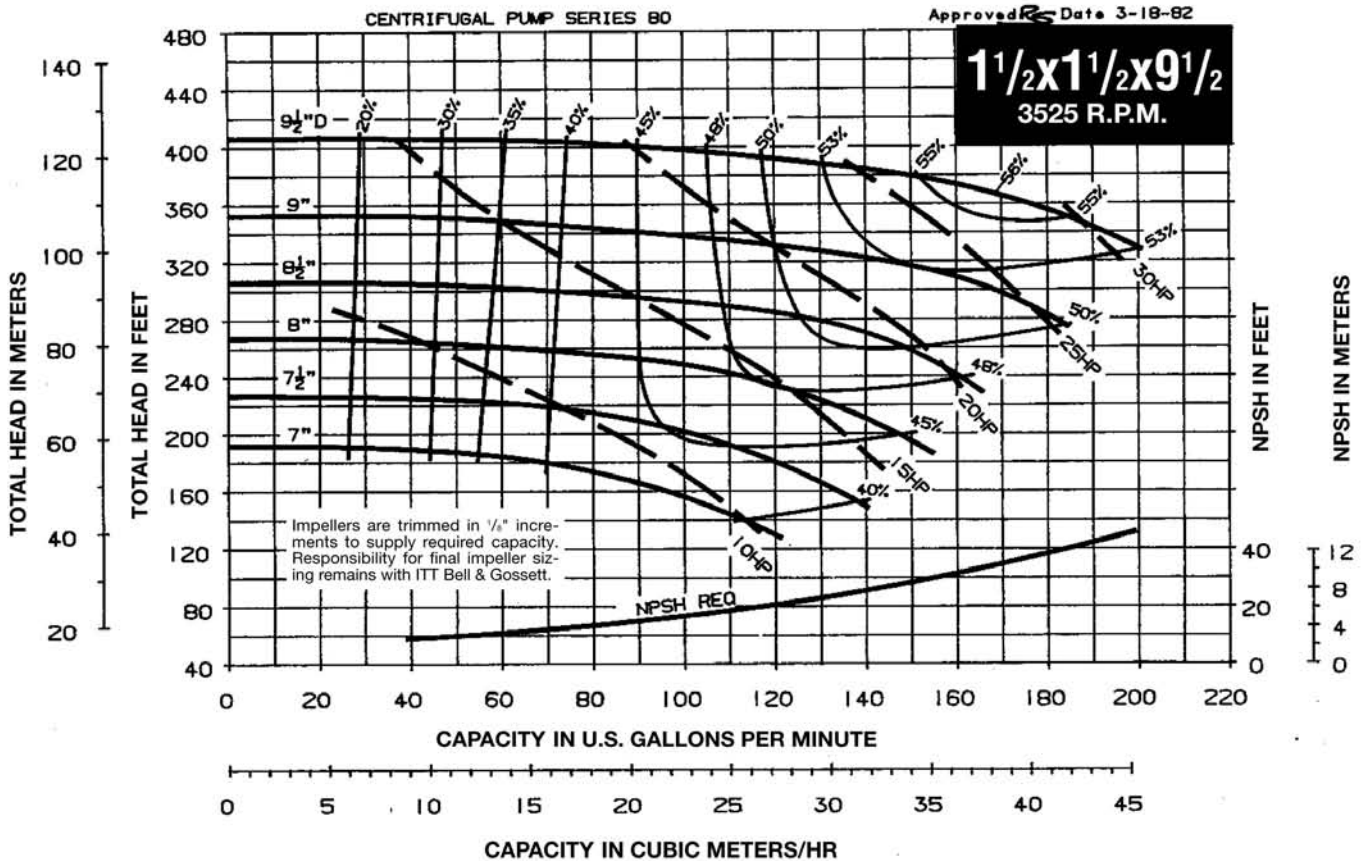
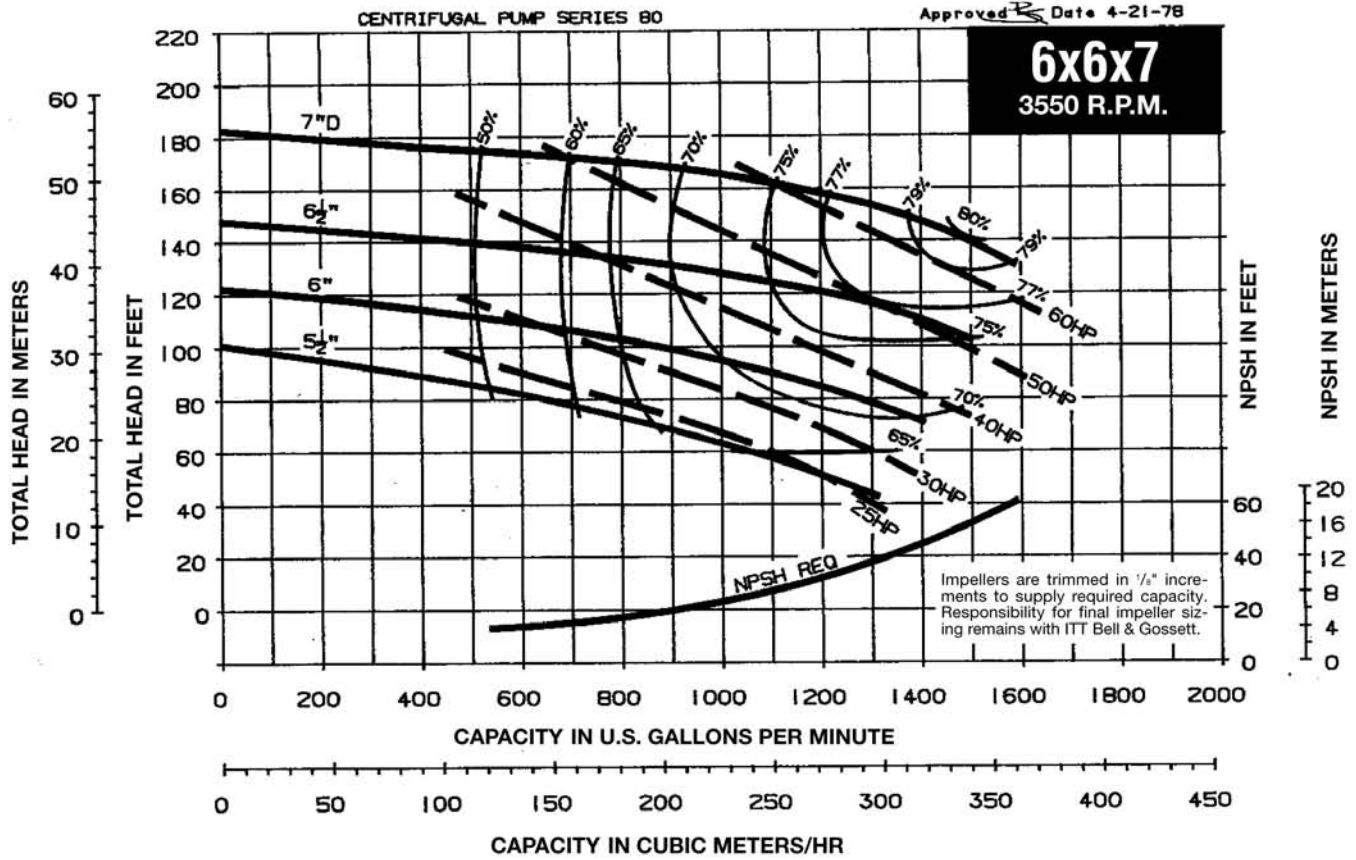

SERIES 80 STANDARD PUMPS

3500 RPM PUMP CURVES

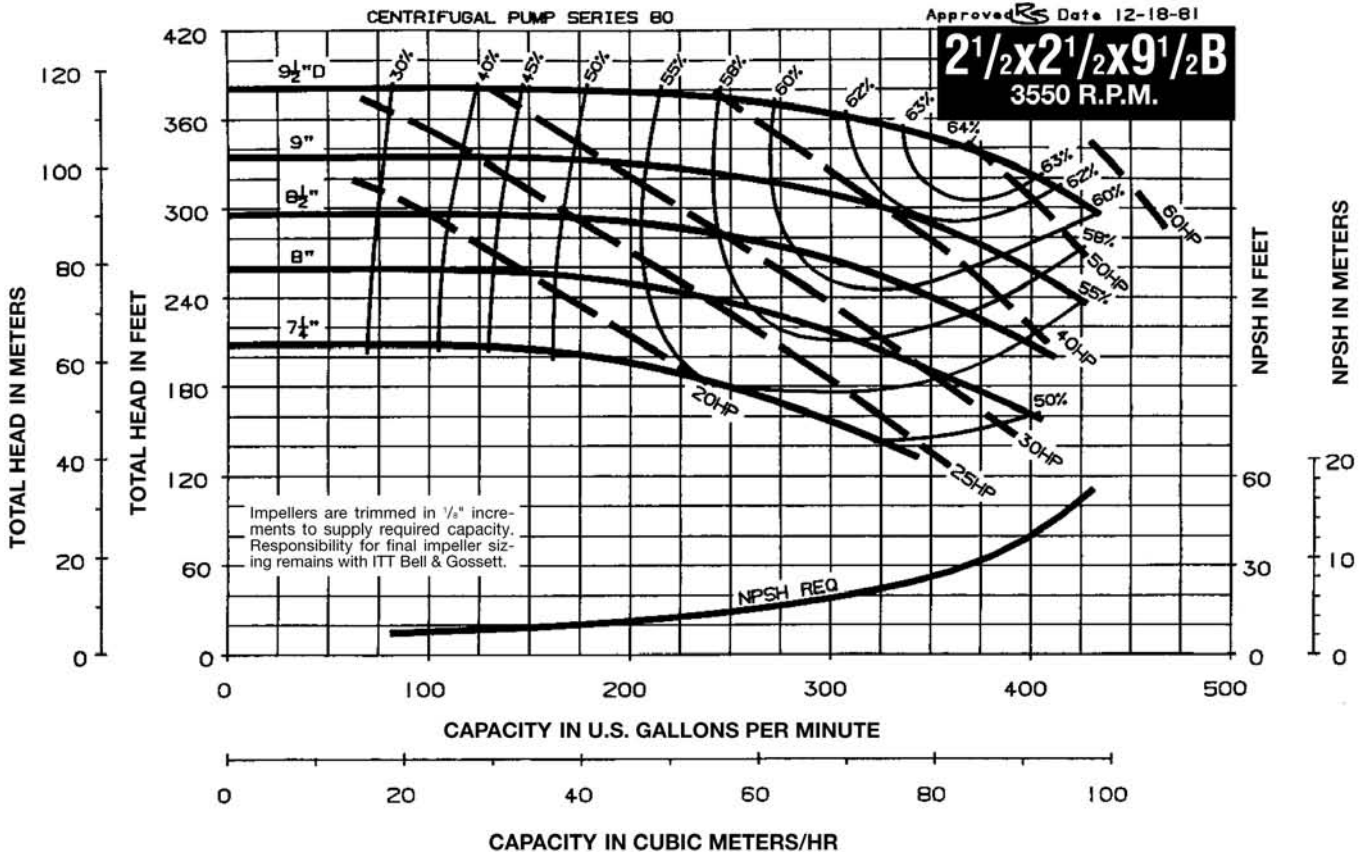
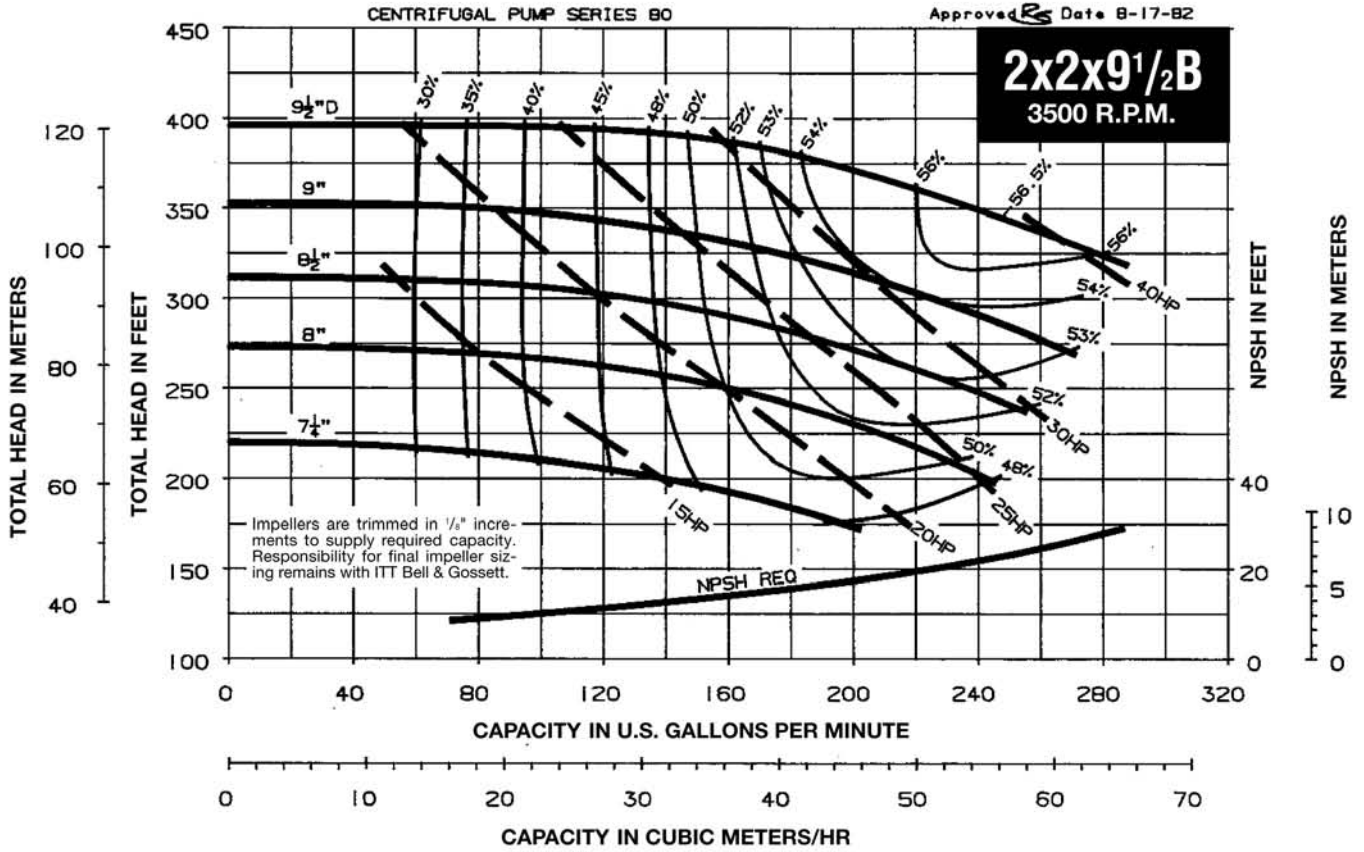

SERIES 80 STANDARD PUMPS

3500 RPM PUMP CURVES

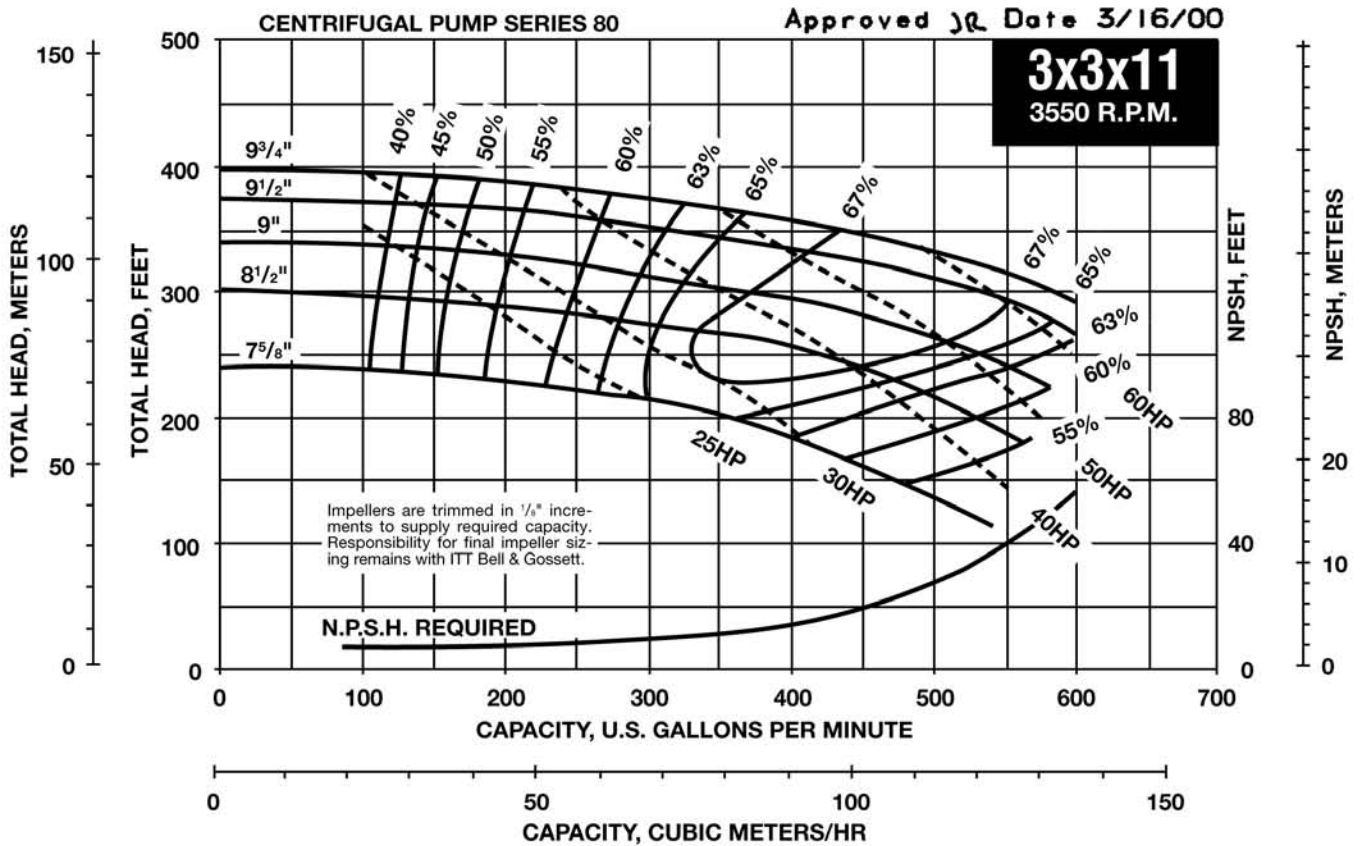
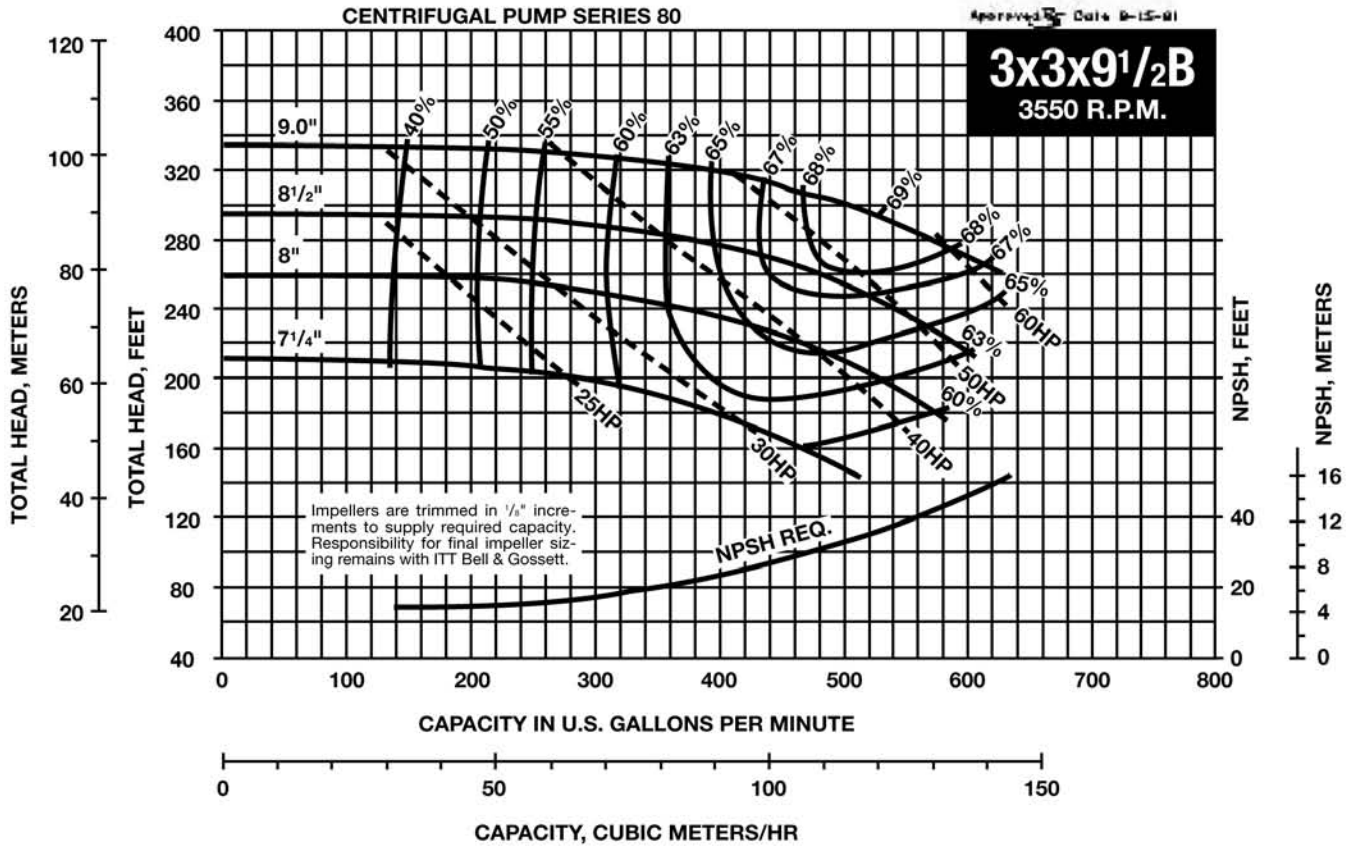

SERIES 80 STANDARD PUMPS

36 gpm each pump; 35 ft hd; 1750 RPM;

Minimum Eff 46%; 1 hp

1750 RPM PUMP CURVES

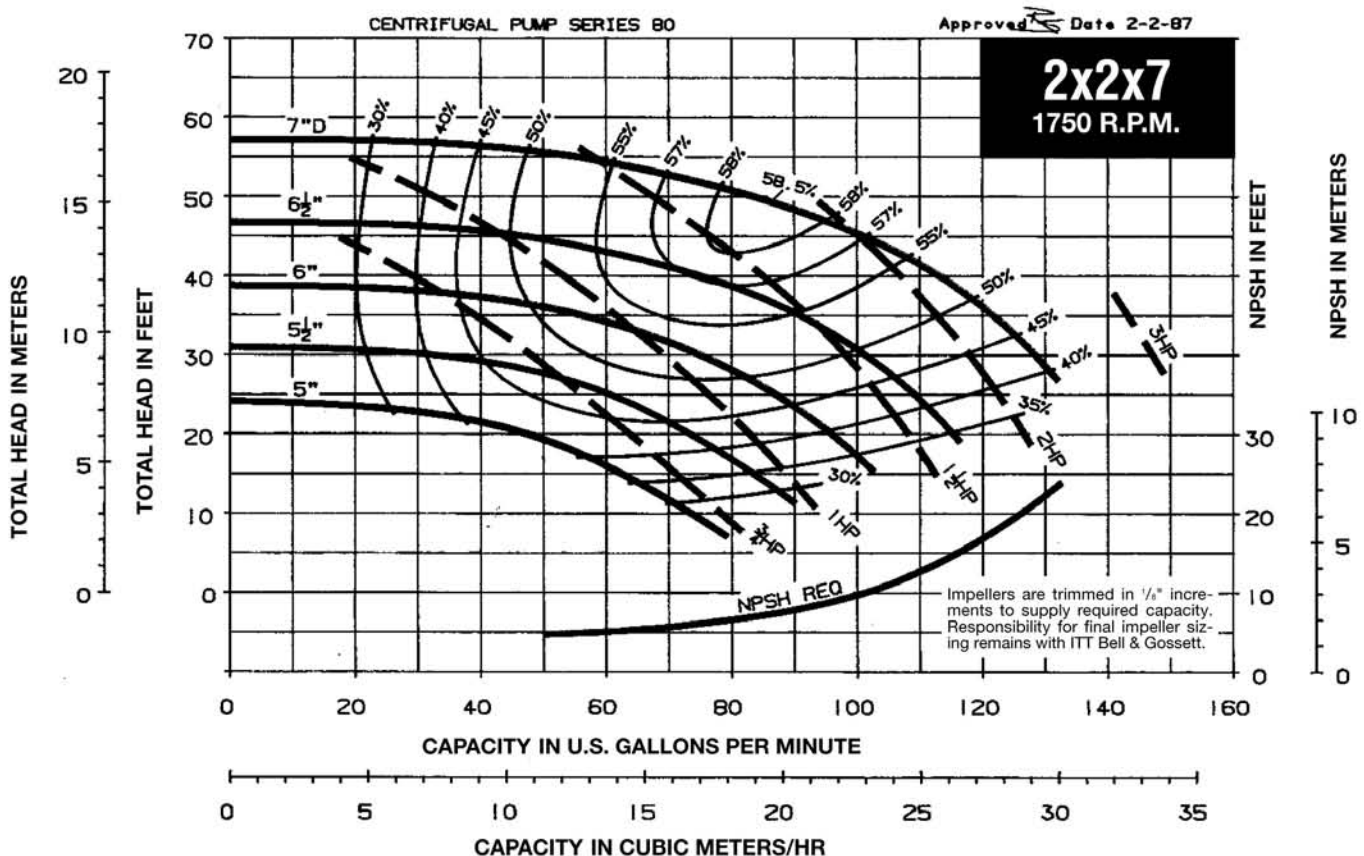
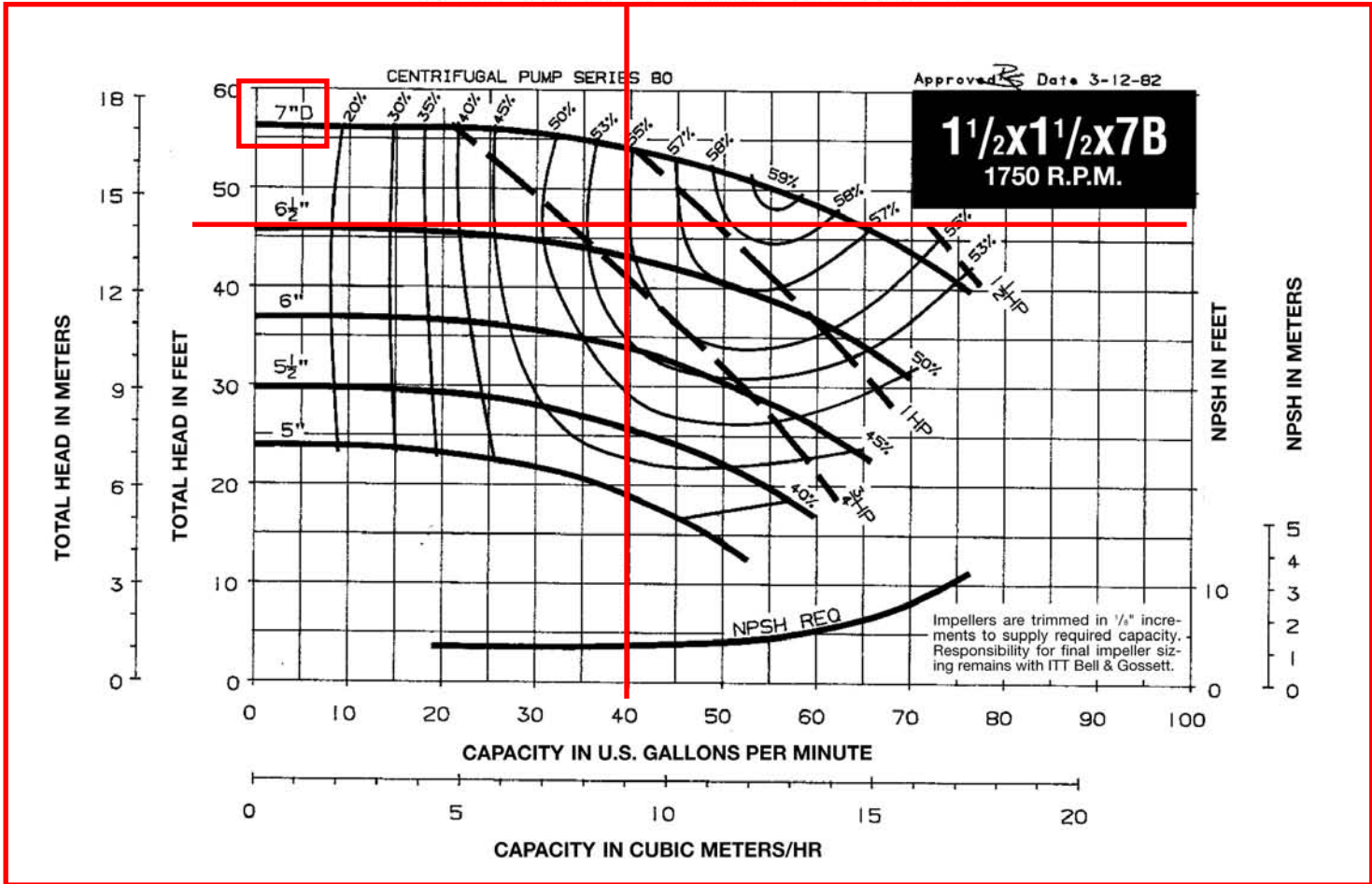

SERIES 80 STANDARD PUMPS

1750 RPM PUMP CURVES

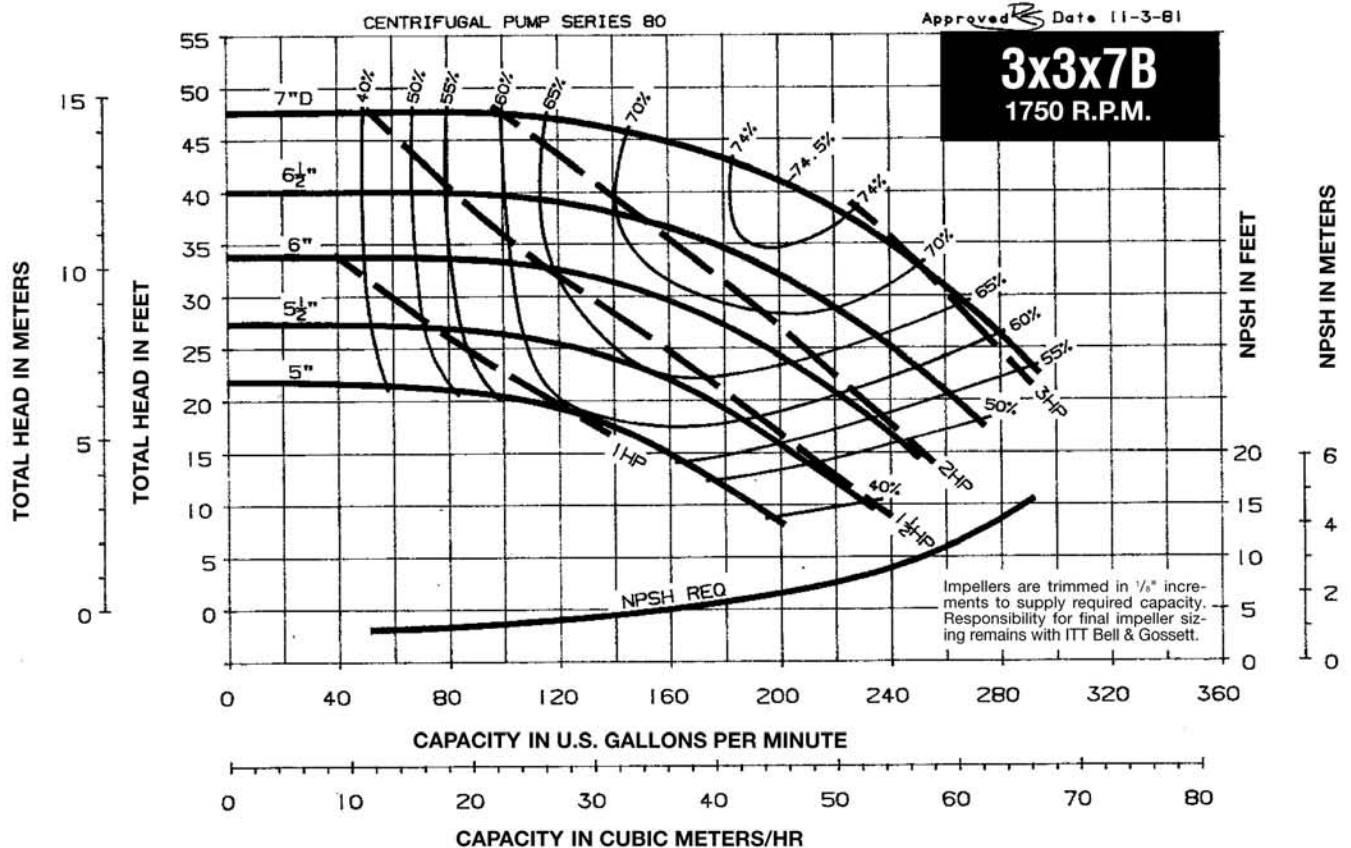
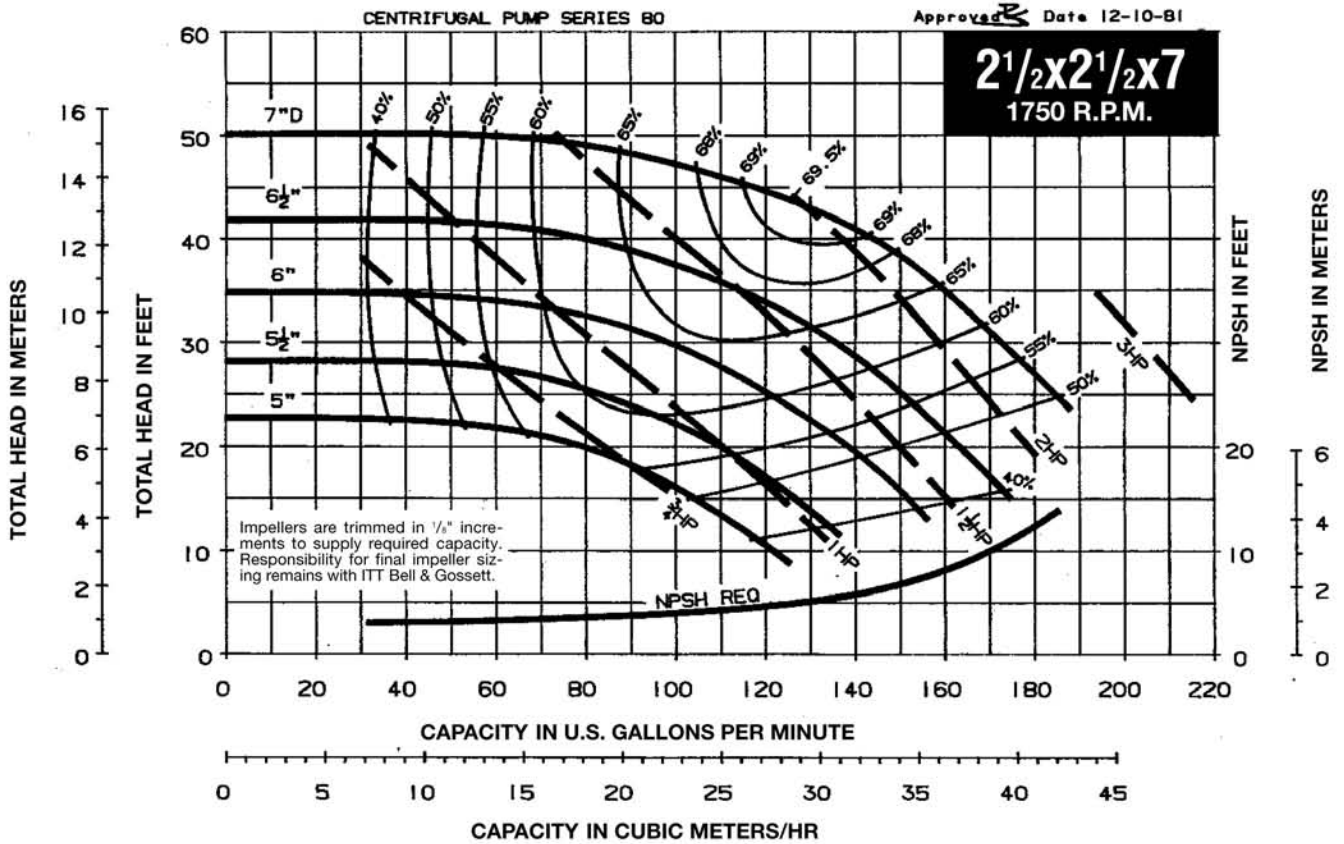

SERIES 80 STANDARD PUMPS

1750 RPM PUMP CURVES

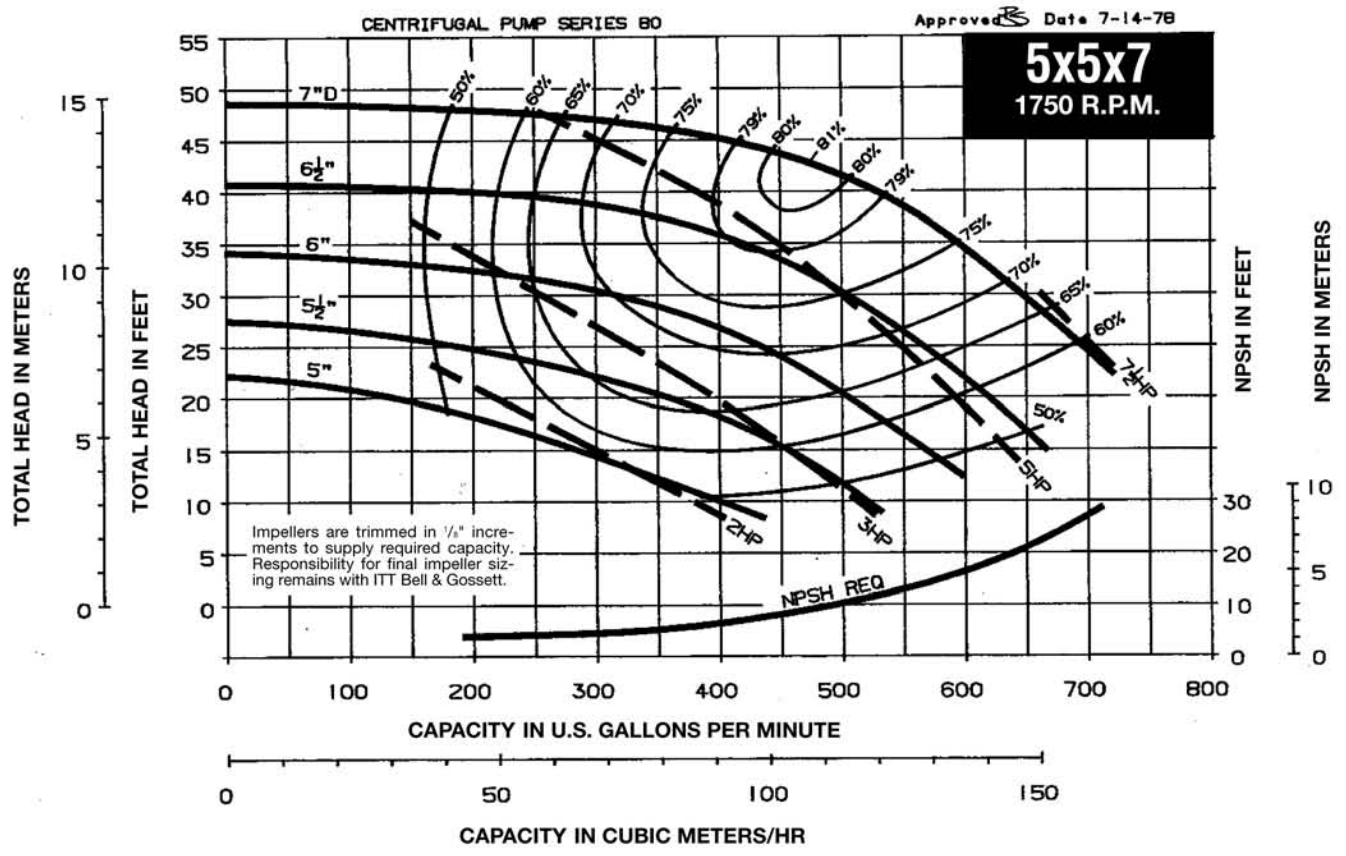
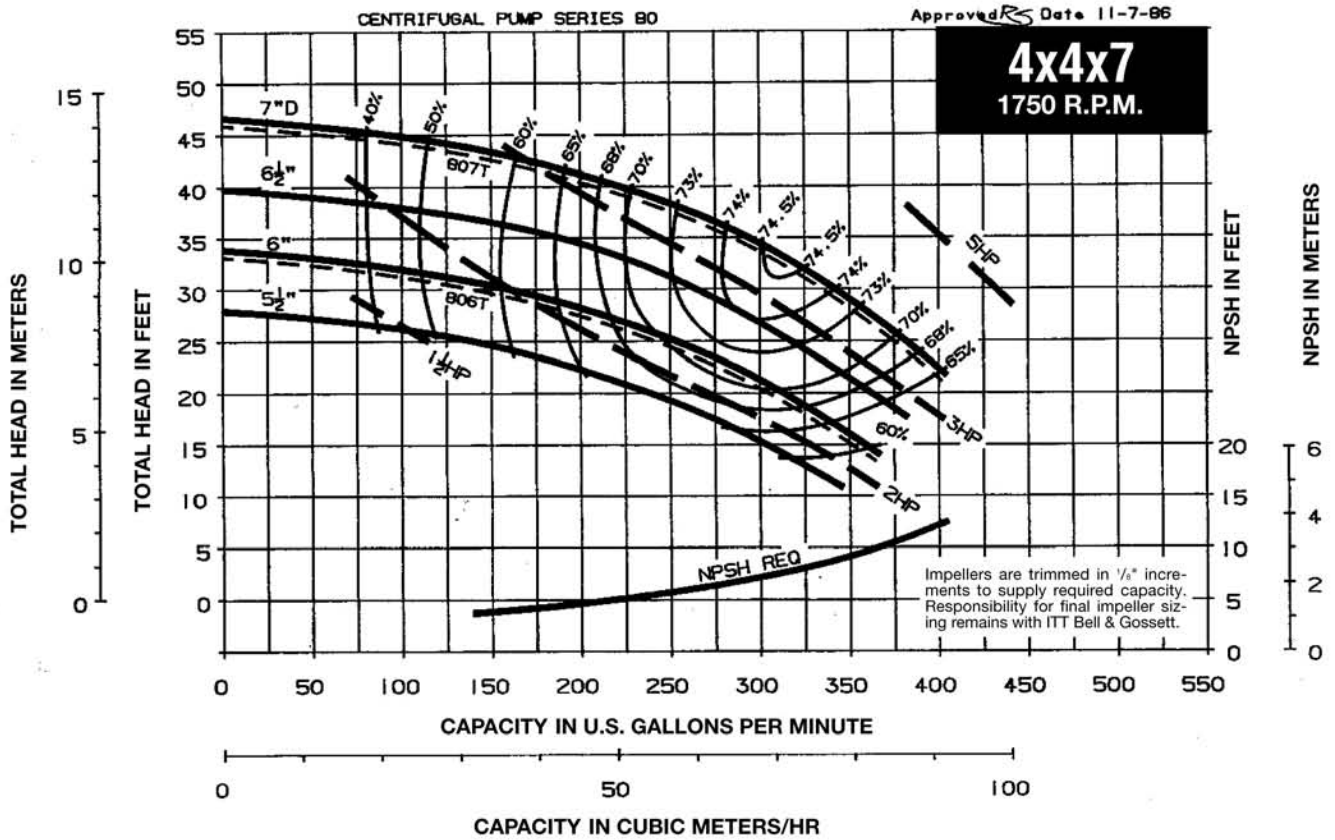

SERIES 80 STANDARD PUMPS

1750 RPM PUMP CURVES

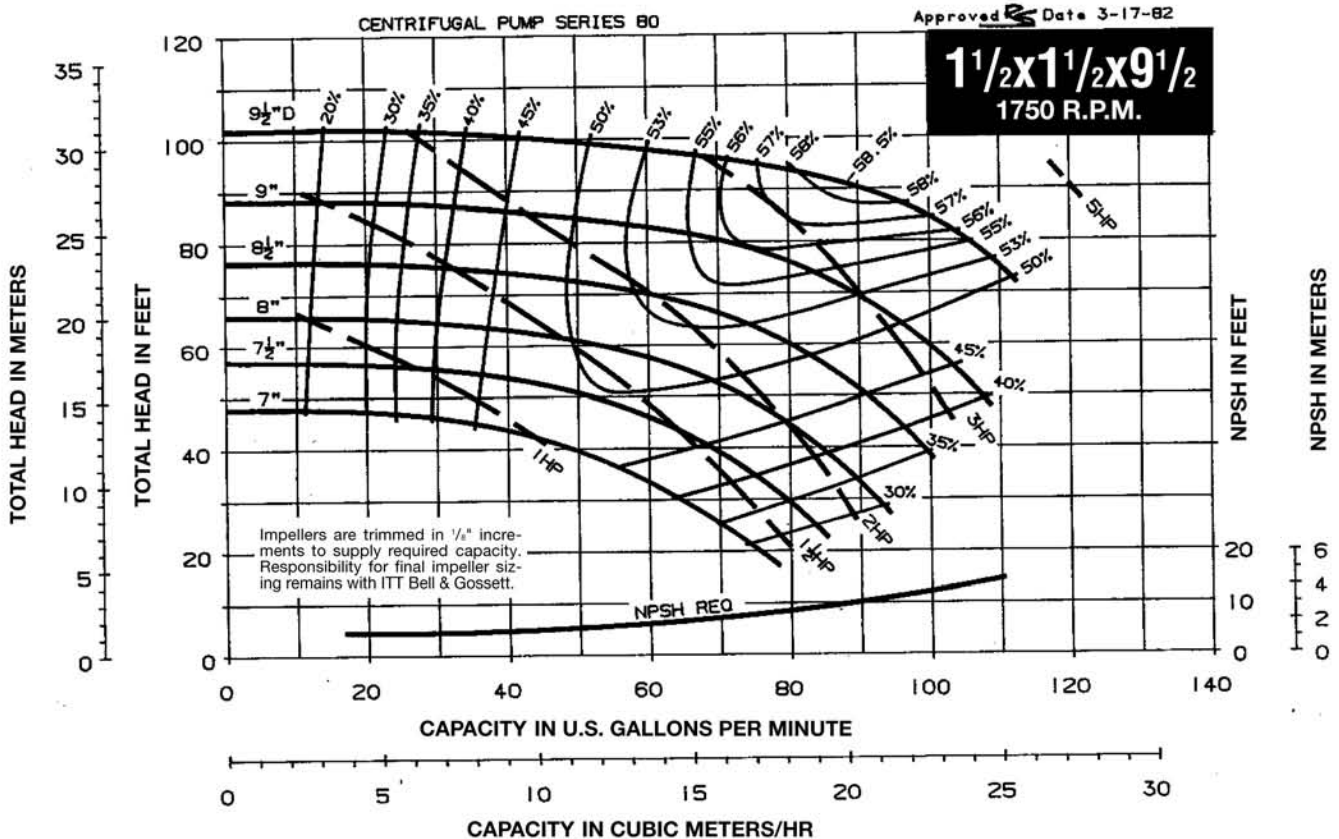
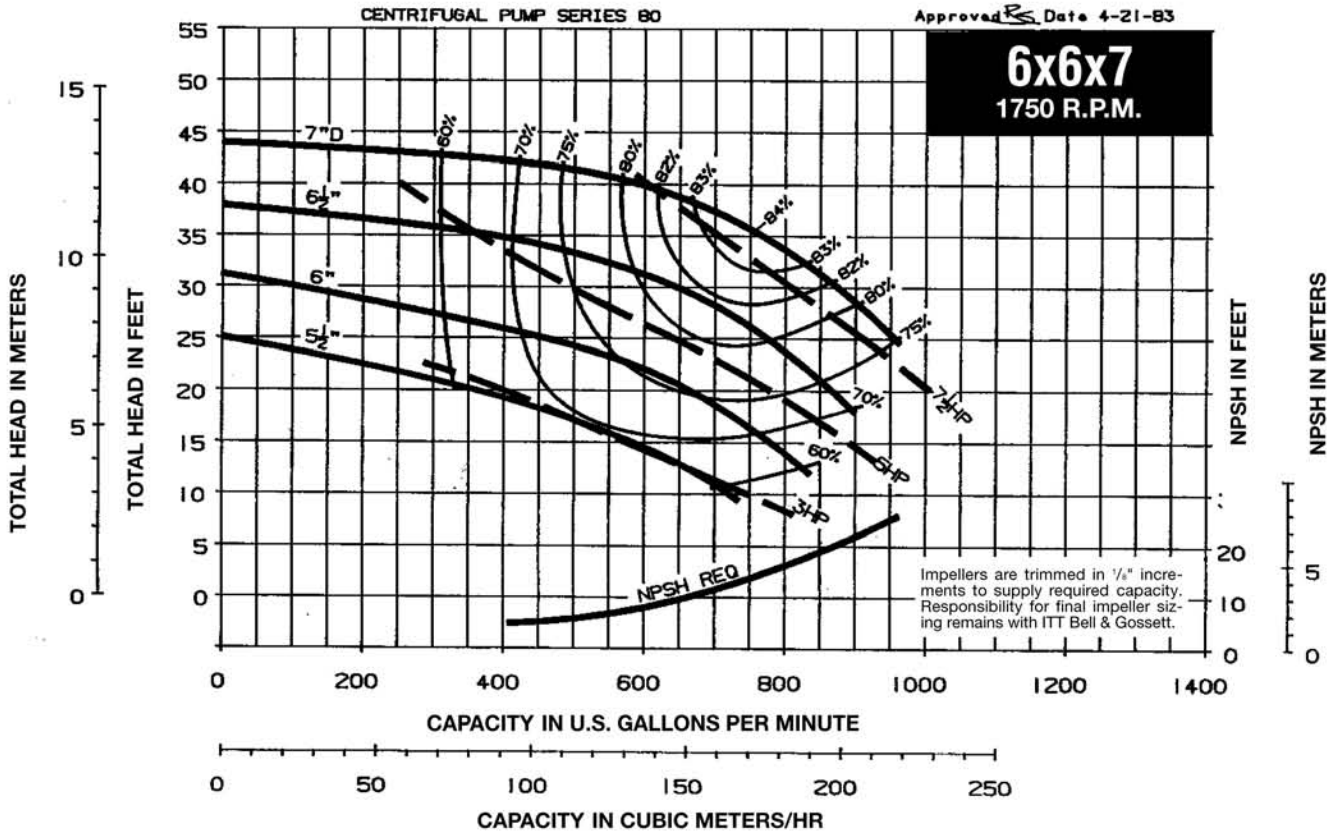

SERIES 80 STANDARD PUMPS

1750 RPM PUMP CURVES

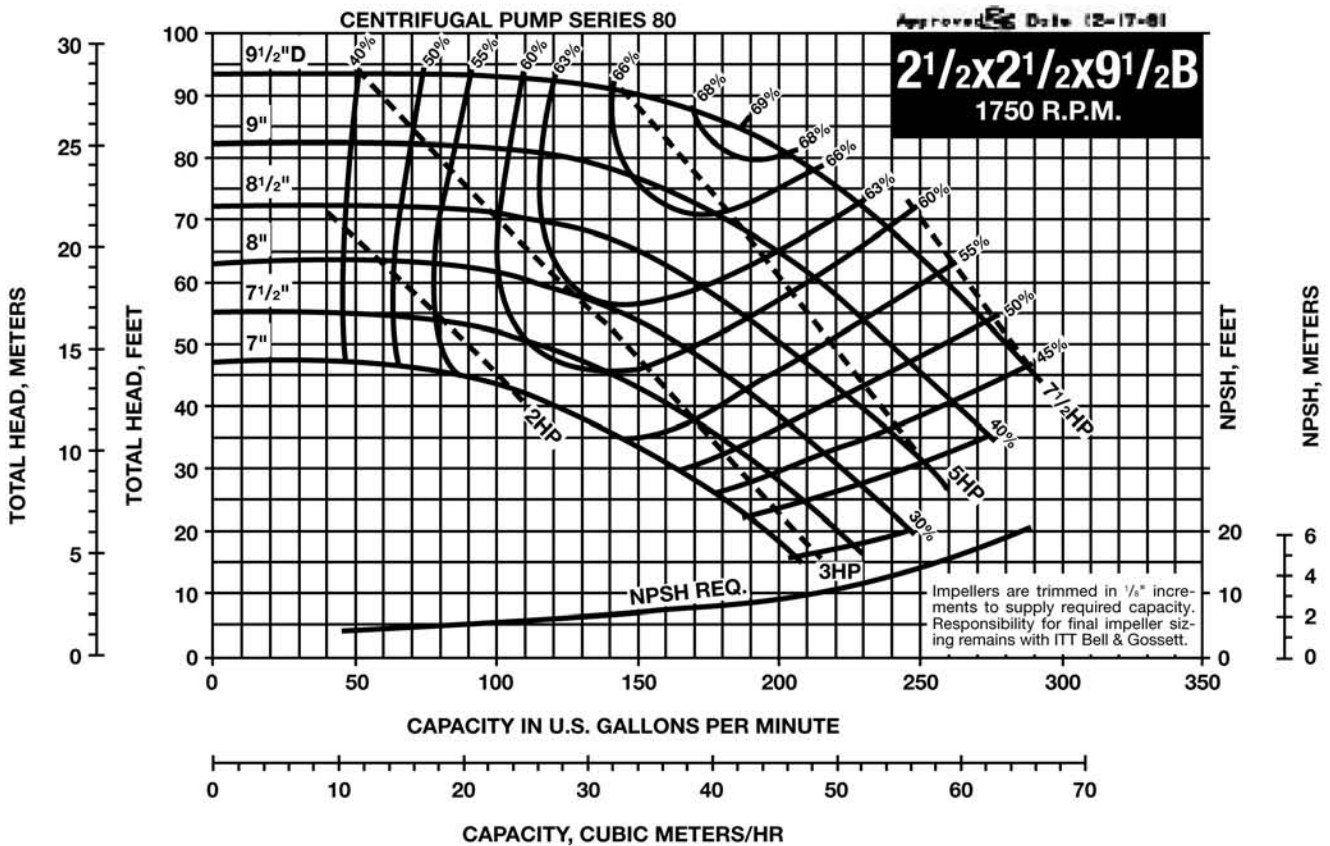
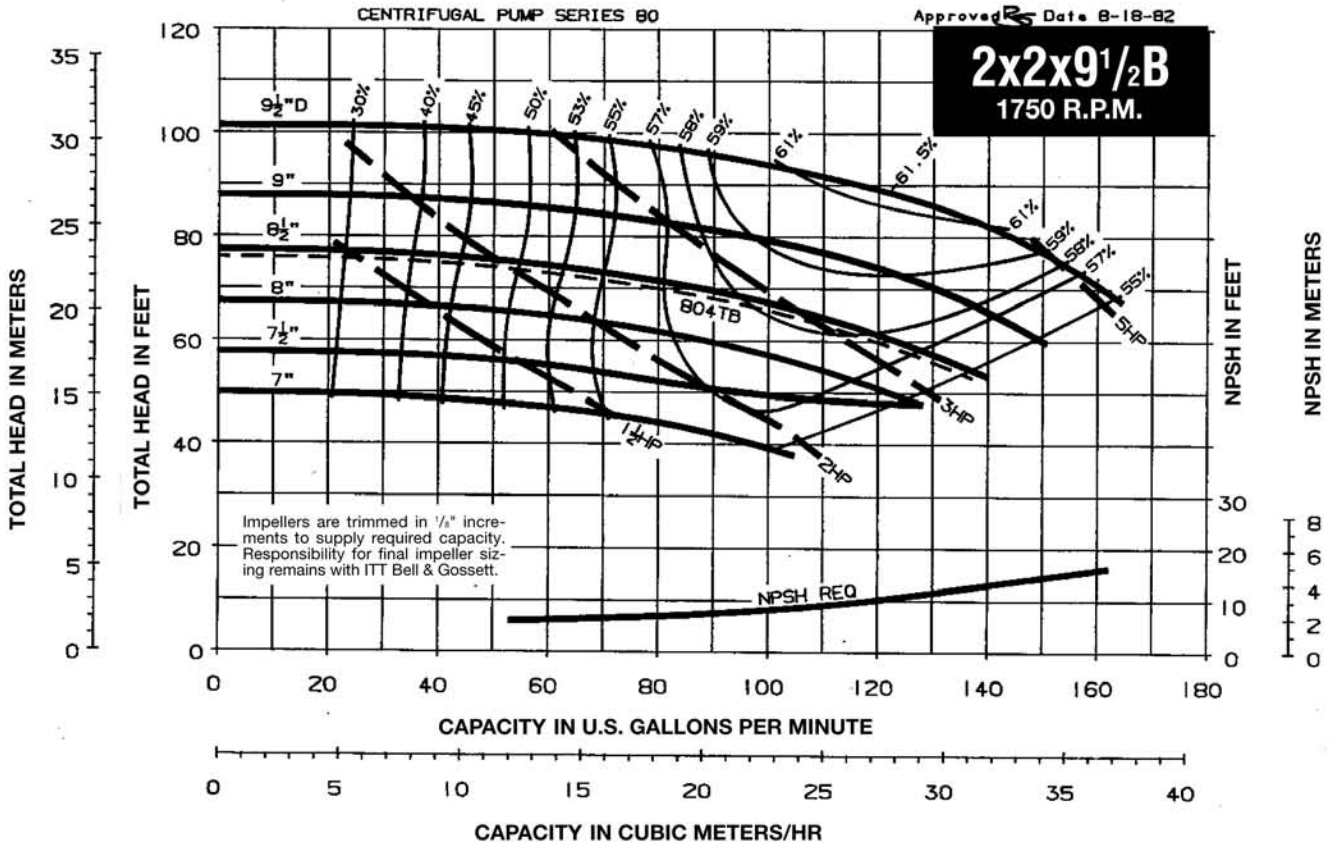

SERIES 80 STANDARD PUMPS

1750 RPM PUMP CURVES

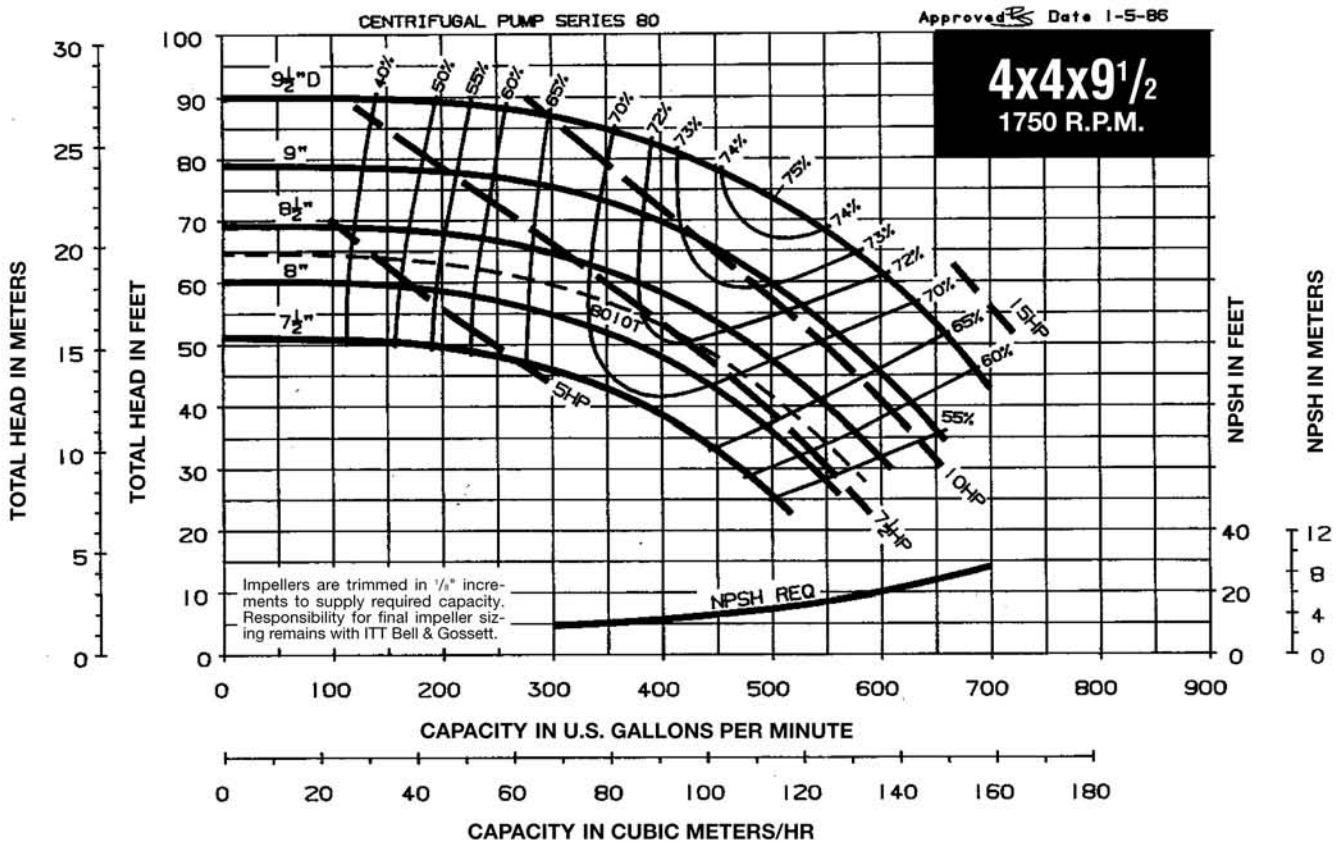
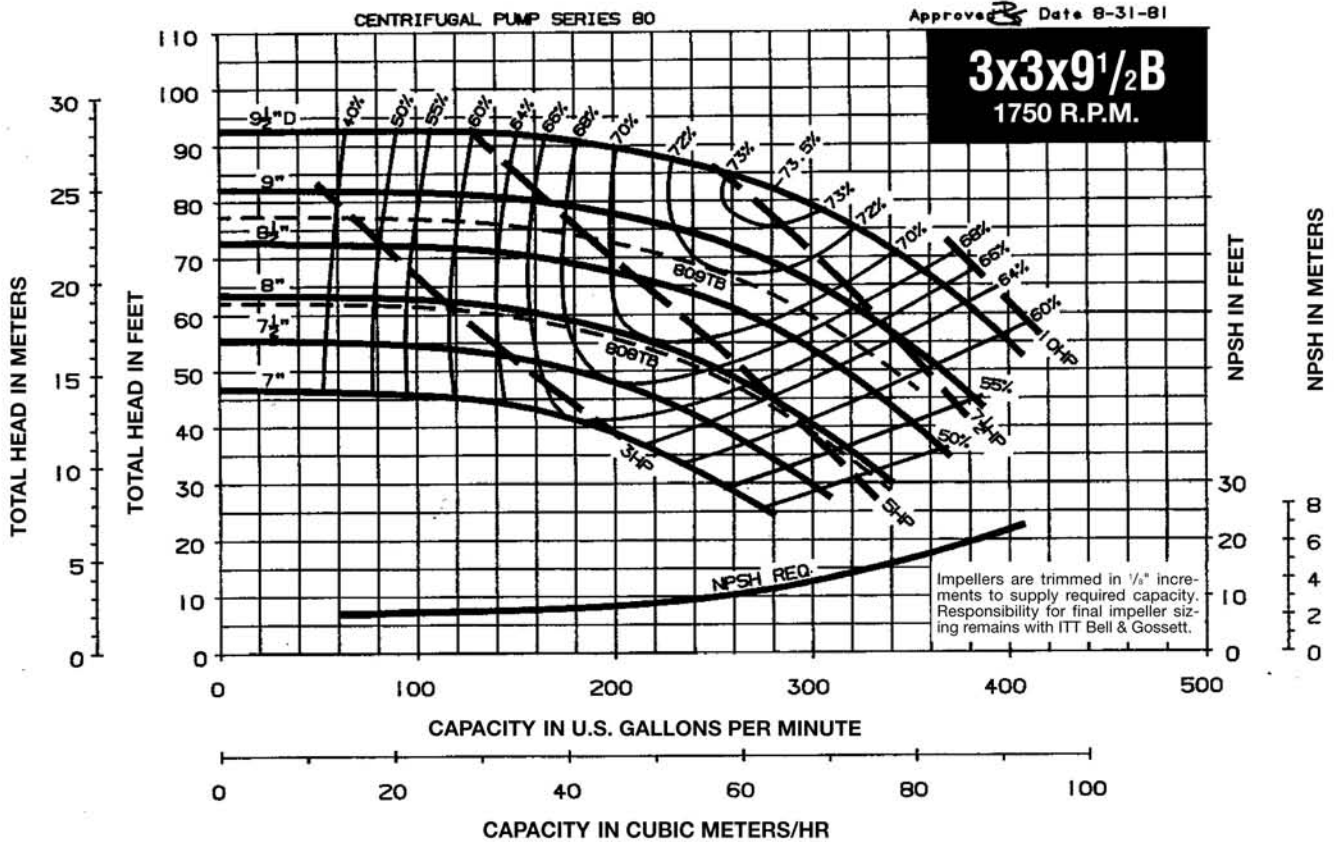

SERIES 80 STANDARD PUMPS

1750 RPM PUMP CURVES

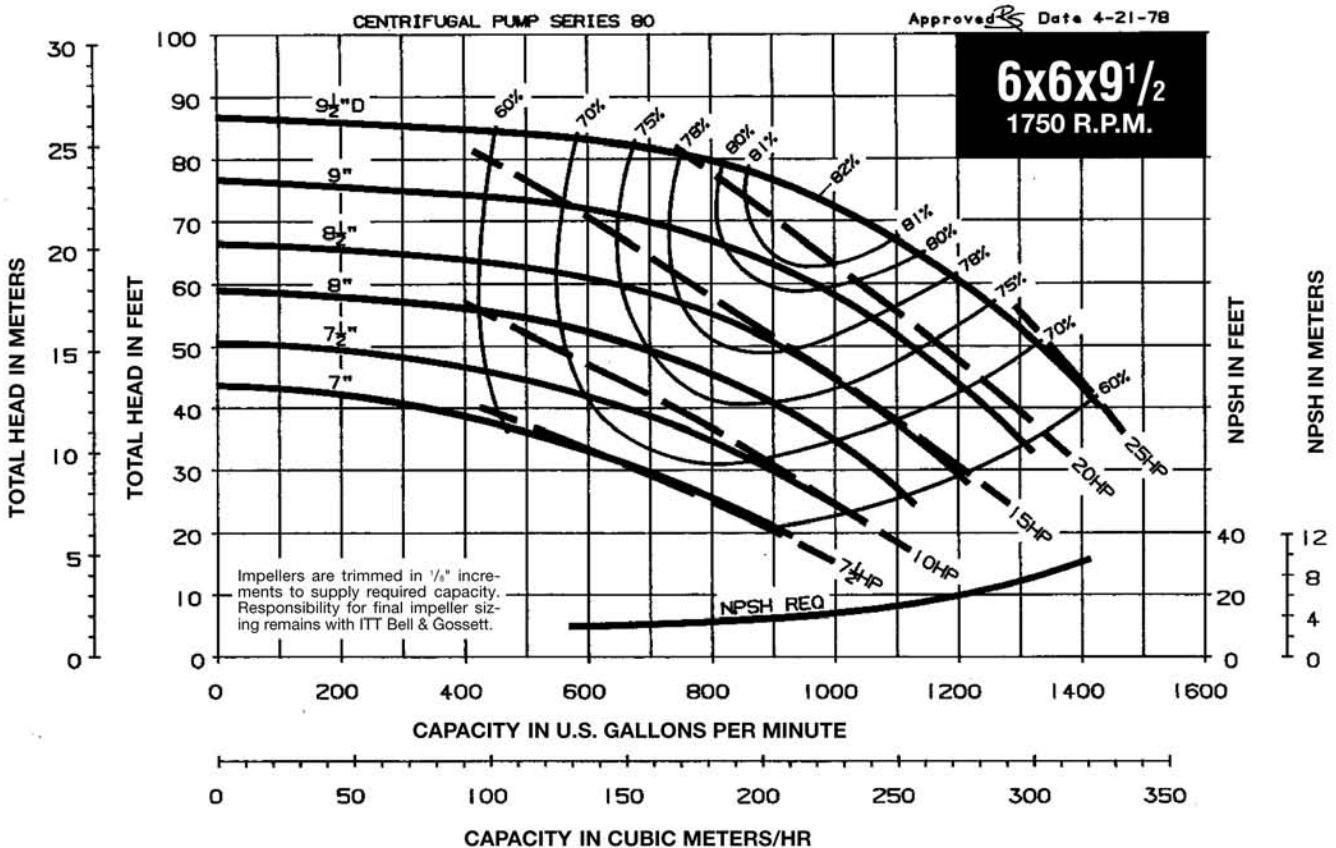
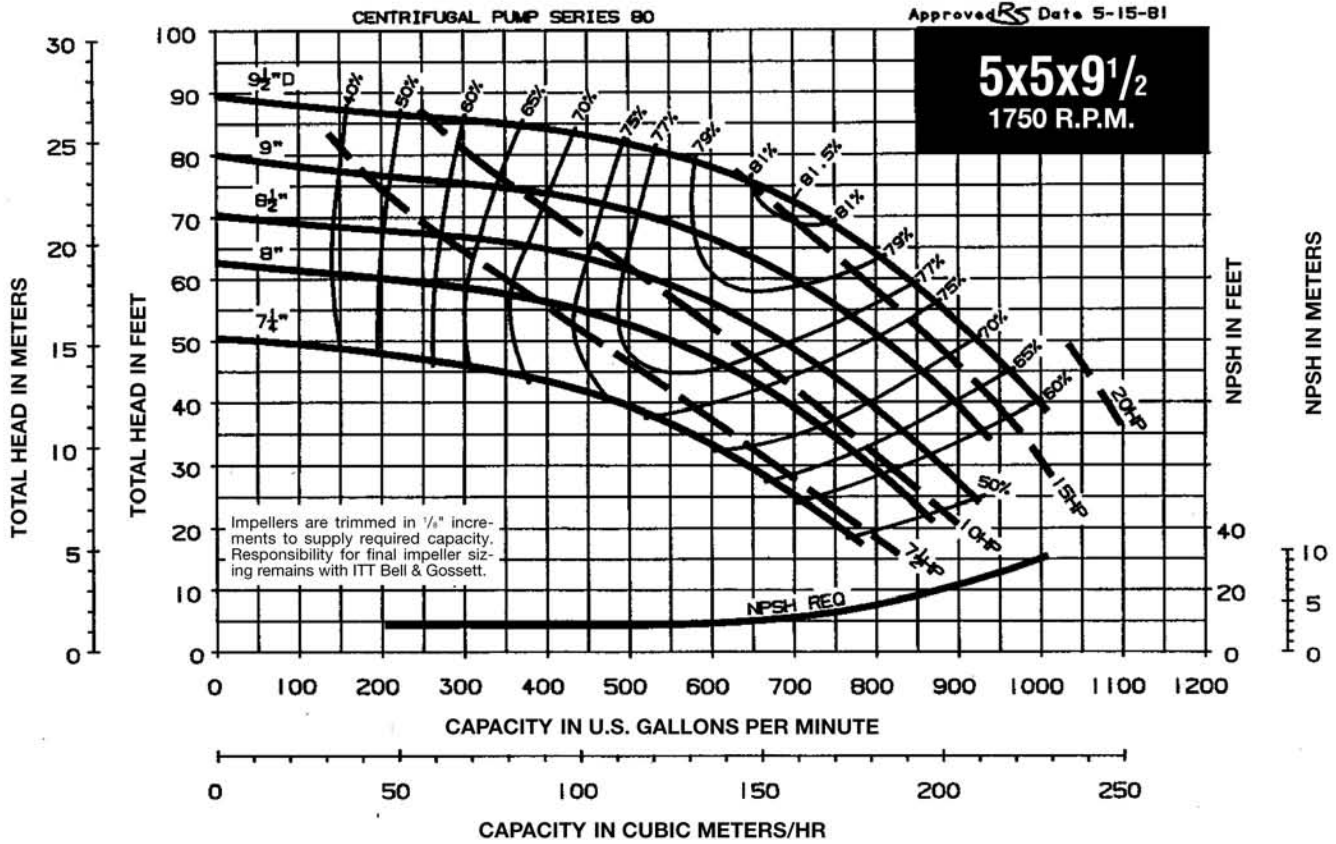

SERIES 80 STANDARD PUMPS

1750 RPM PUMP CURVES

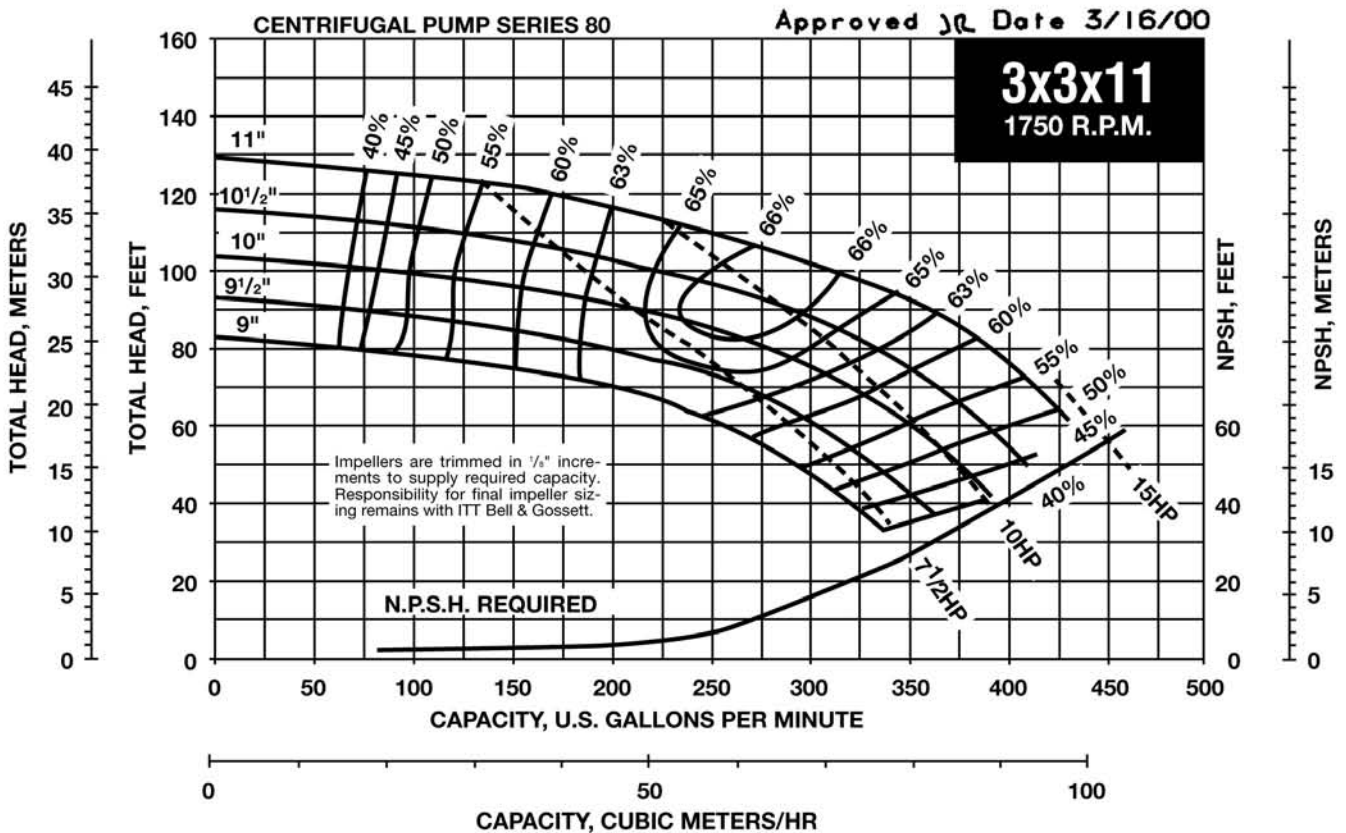
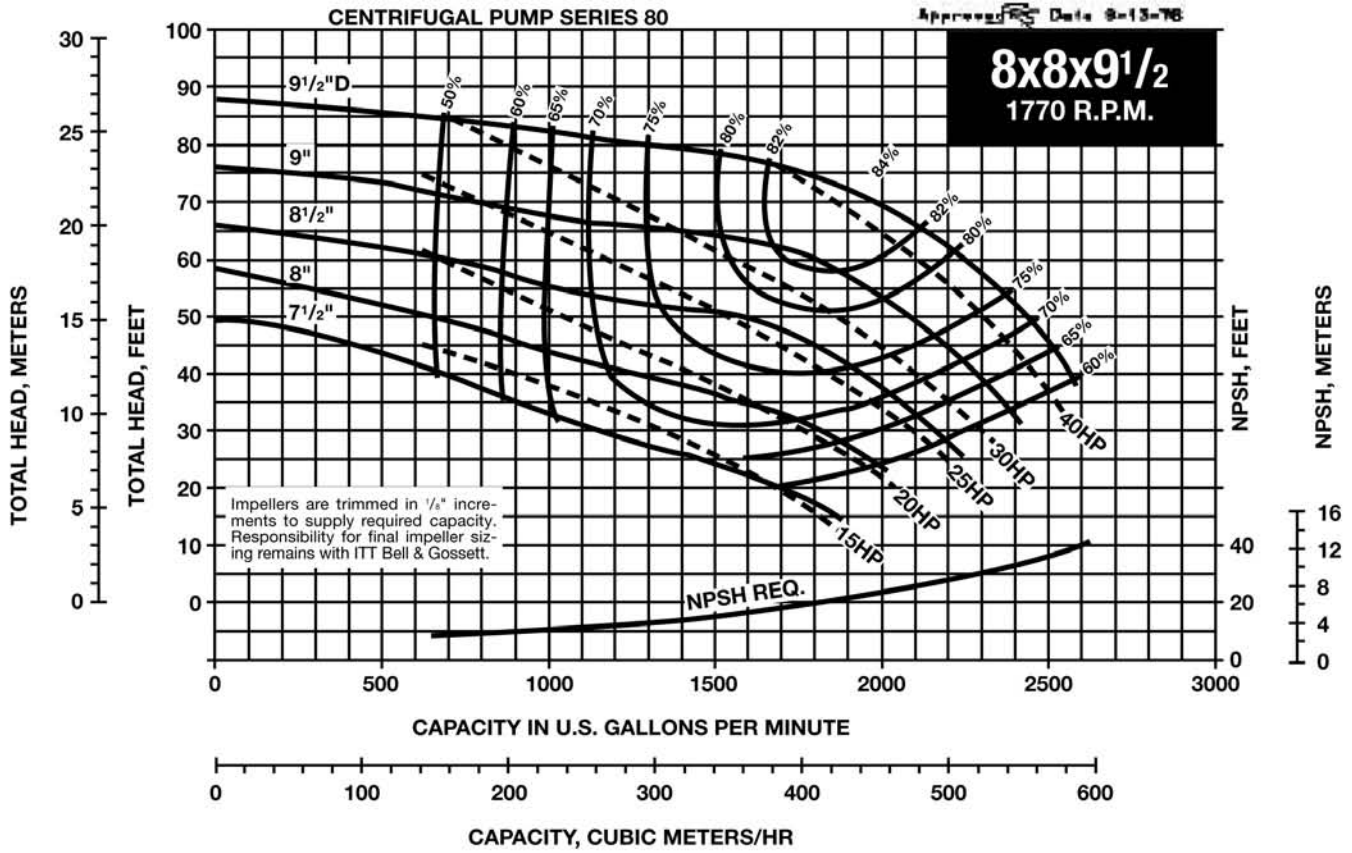

SERIES 80 STANDARD PUMPS

1750 RPM PUMP CURVES

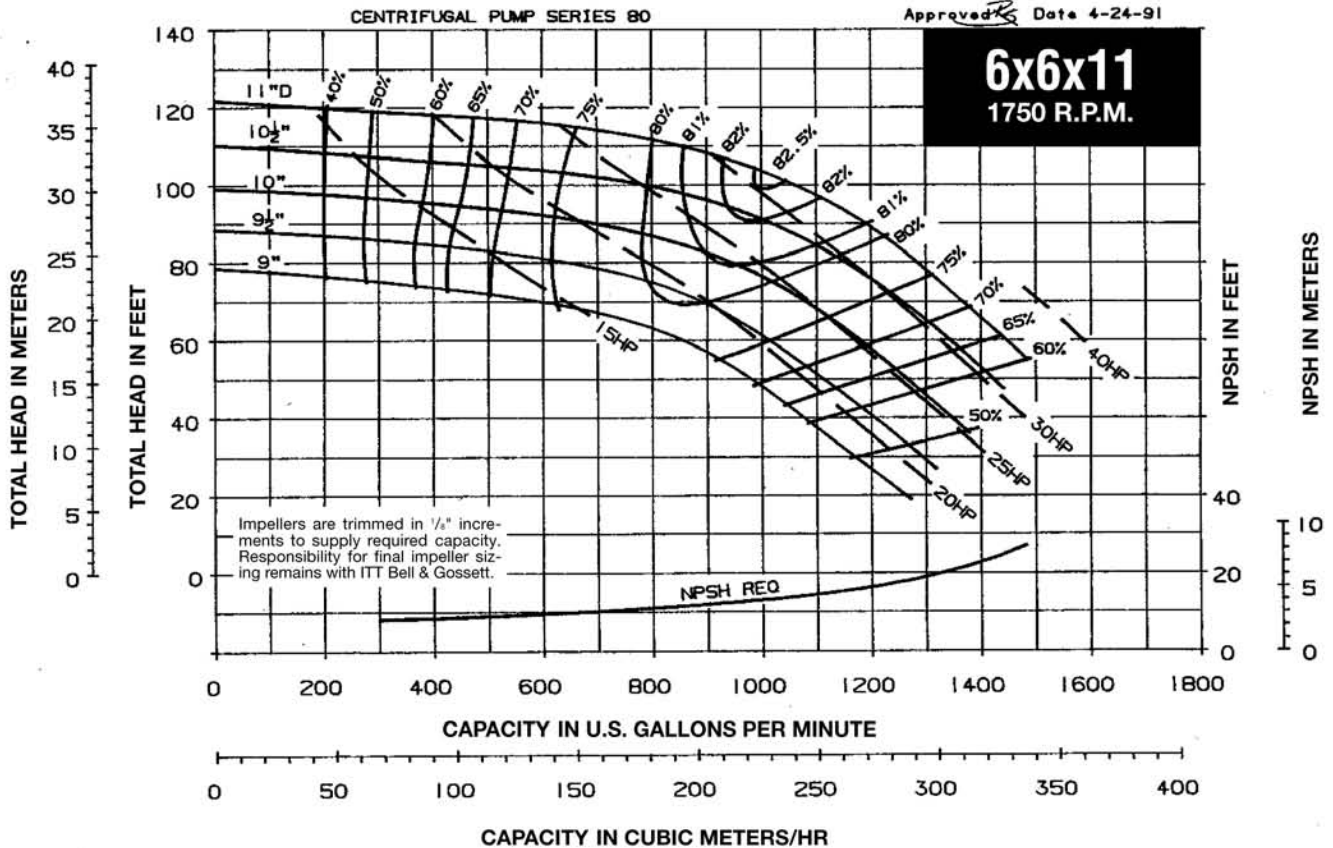
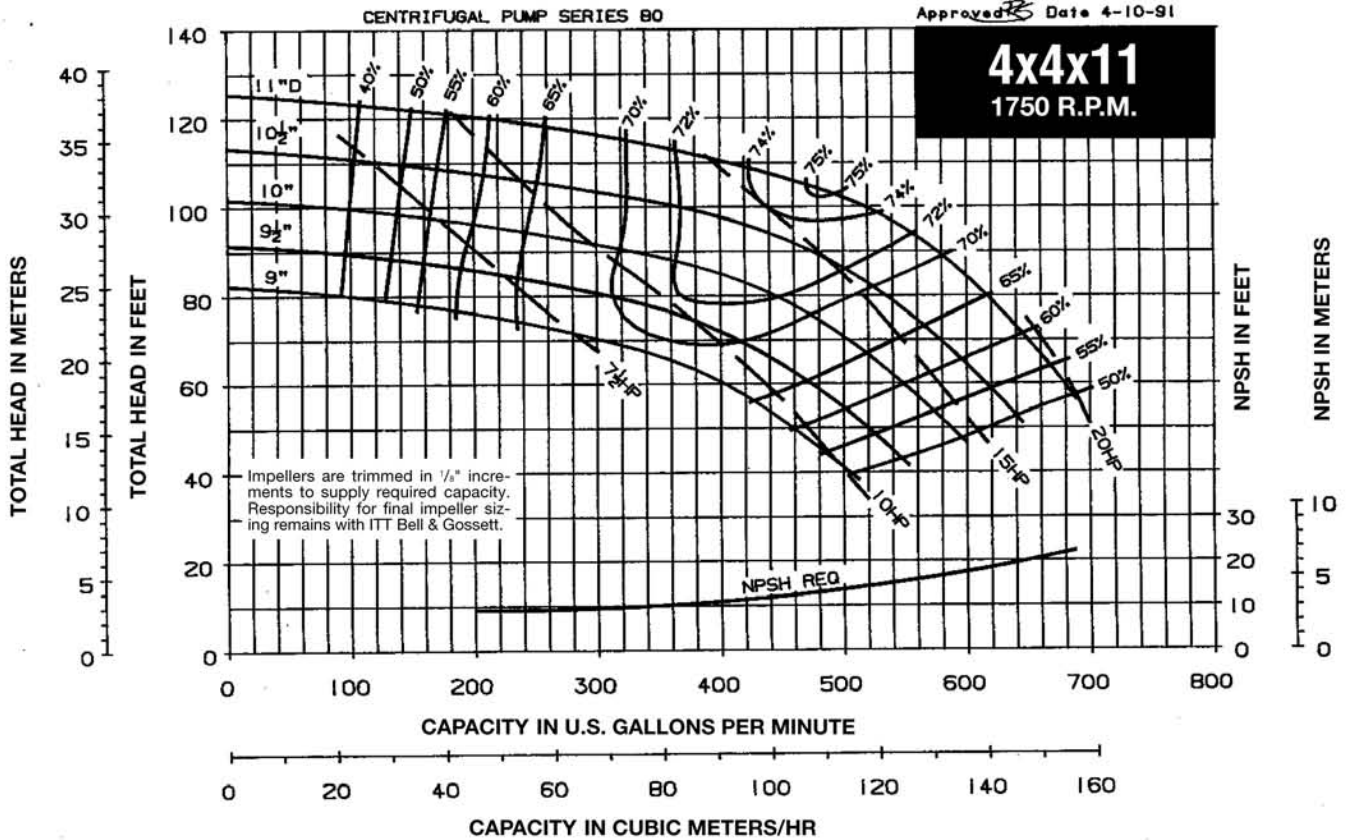

SERIES 80 STANDARD PUMPS

1750 RPM PUMP CURVES

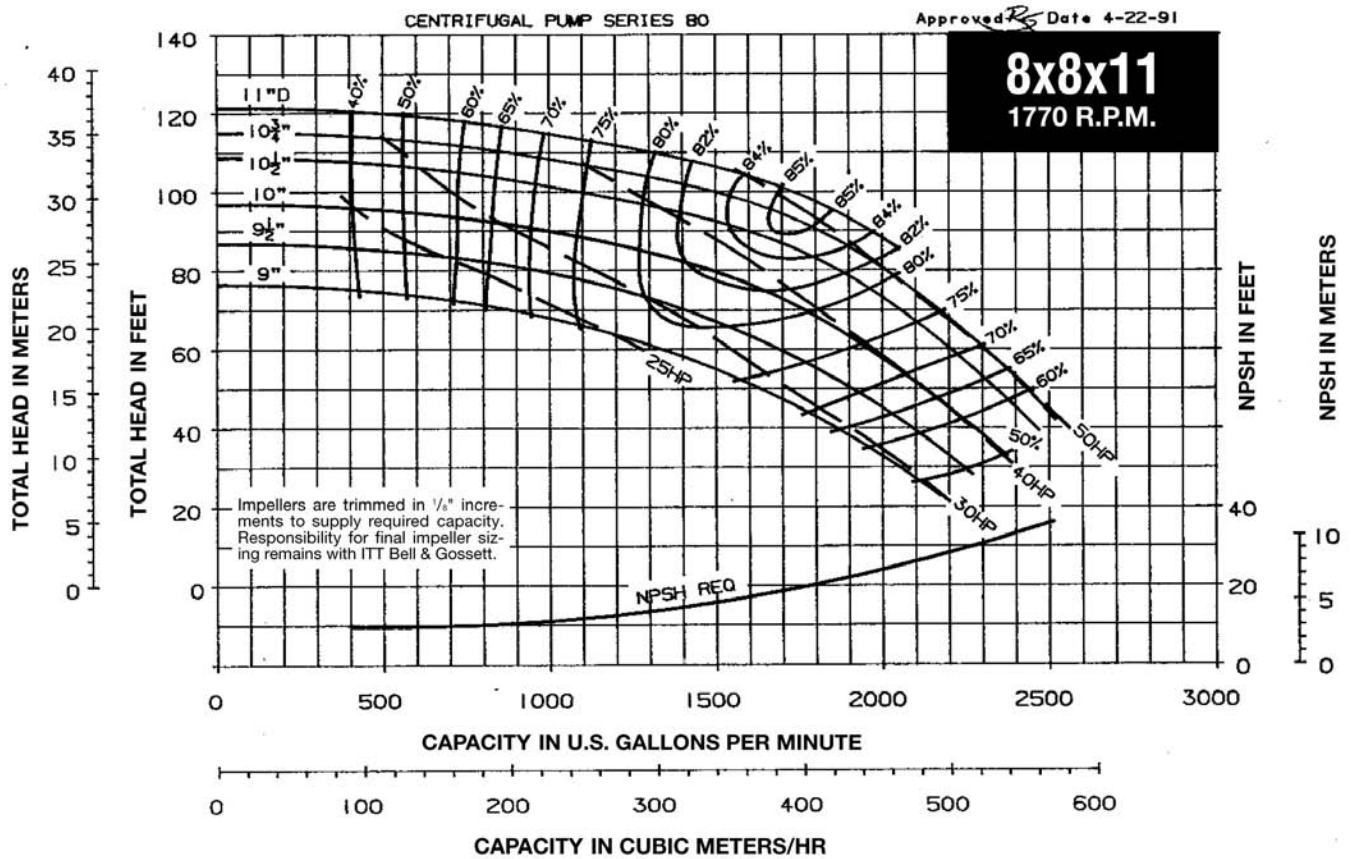

SERIES 80 STANDARD PUMPS

1150 RPM PUMP CURVES

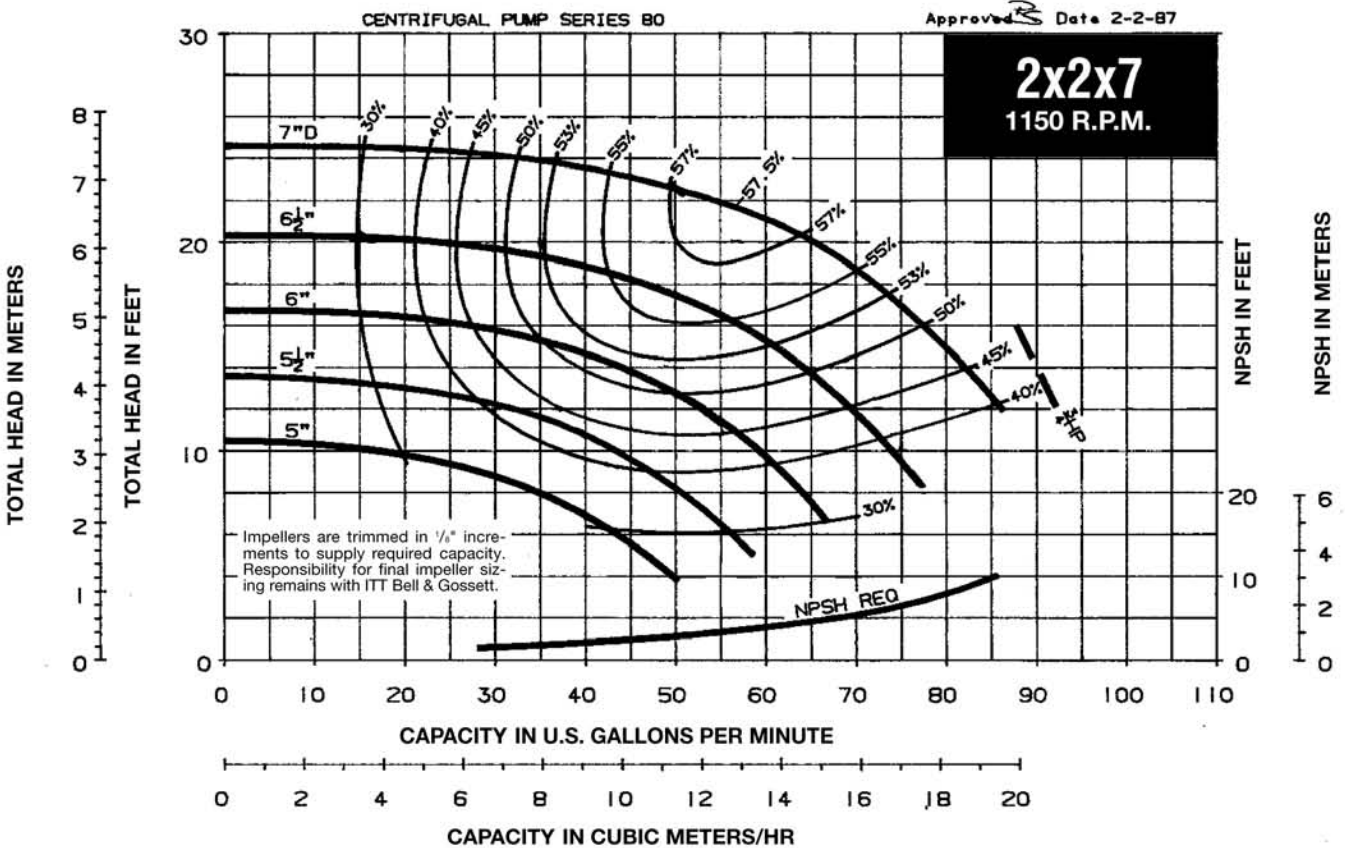
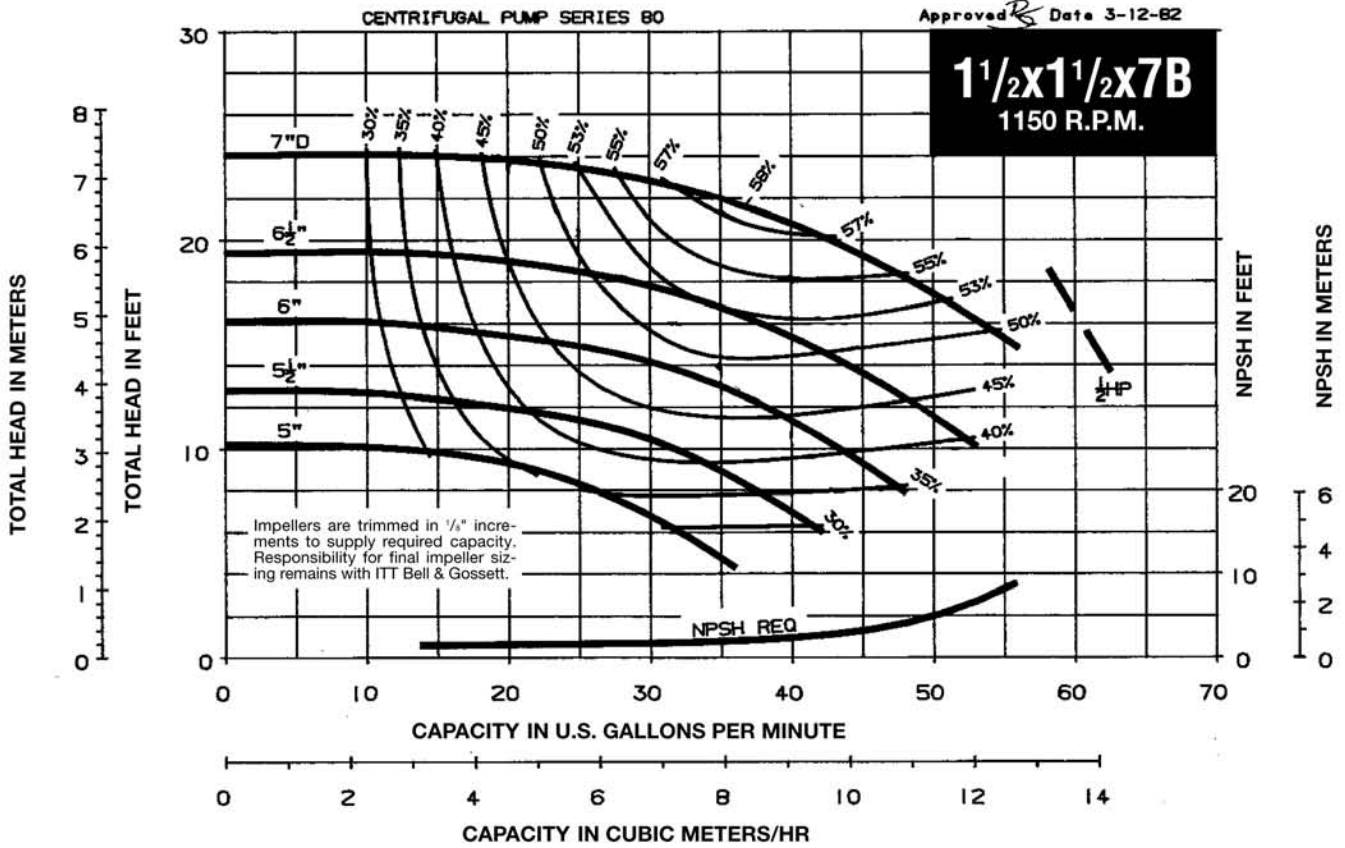

SERIES 80 STANDARD PUMPS

1150 RPM PUMP CURVES

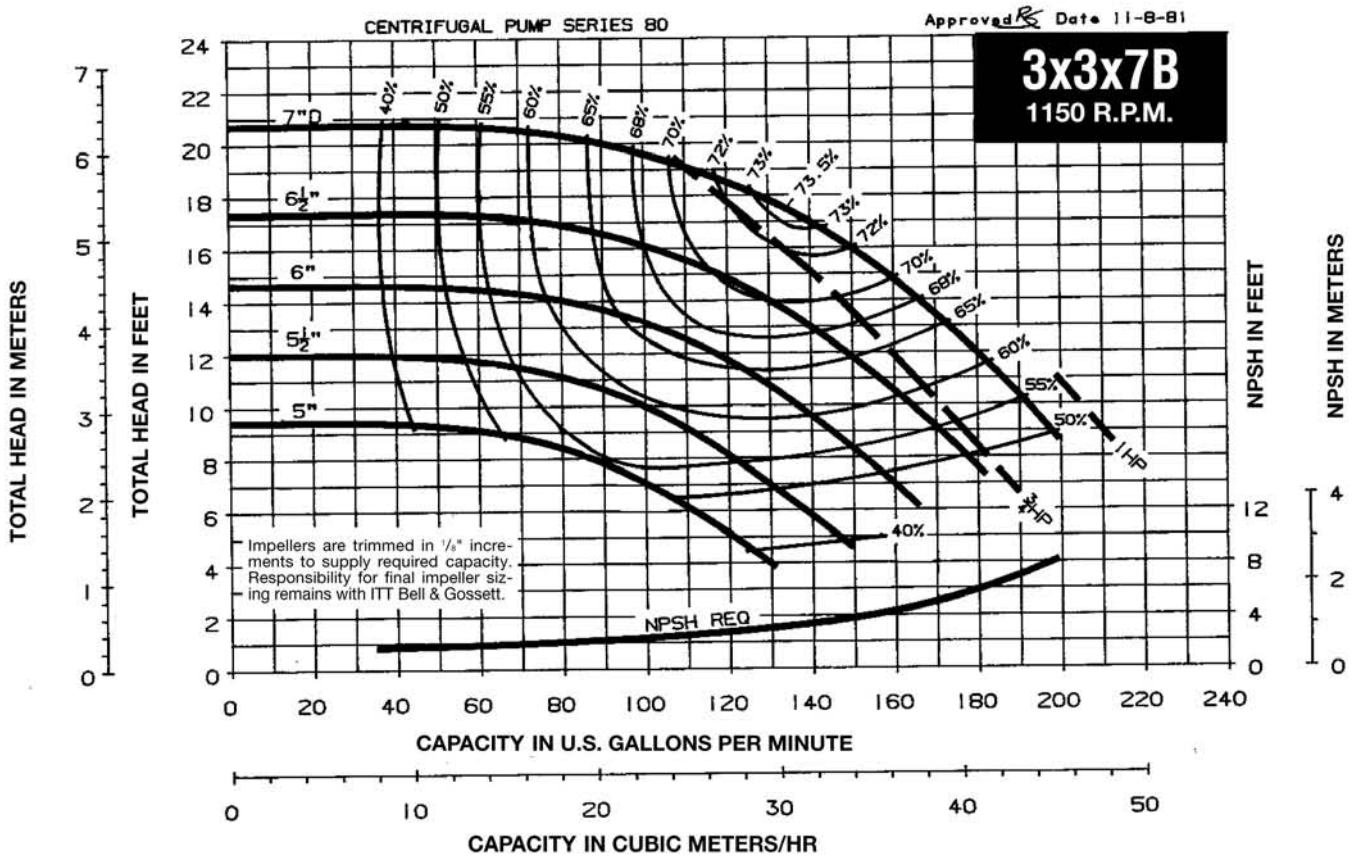
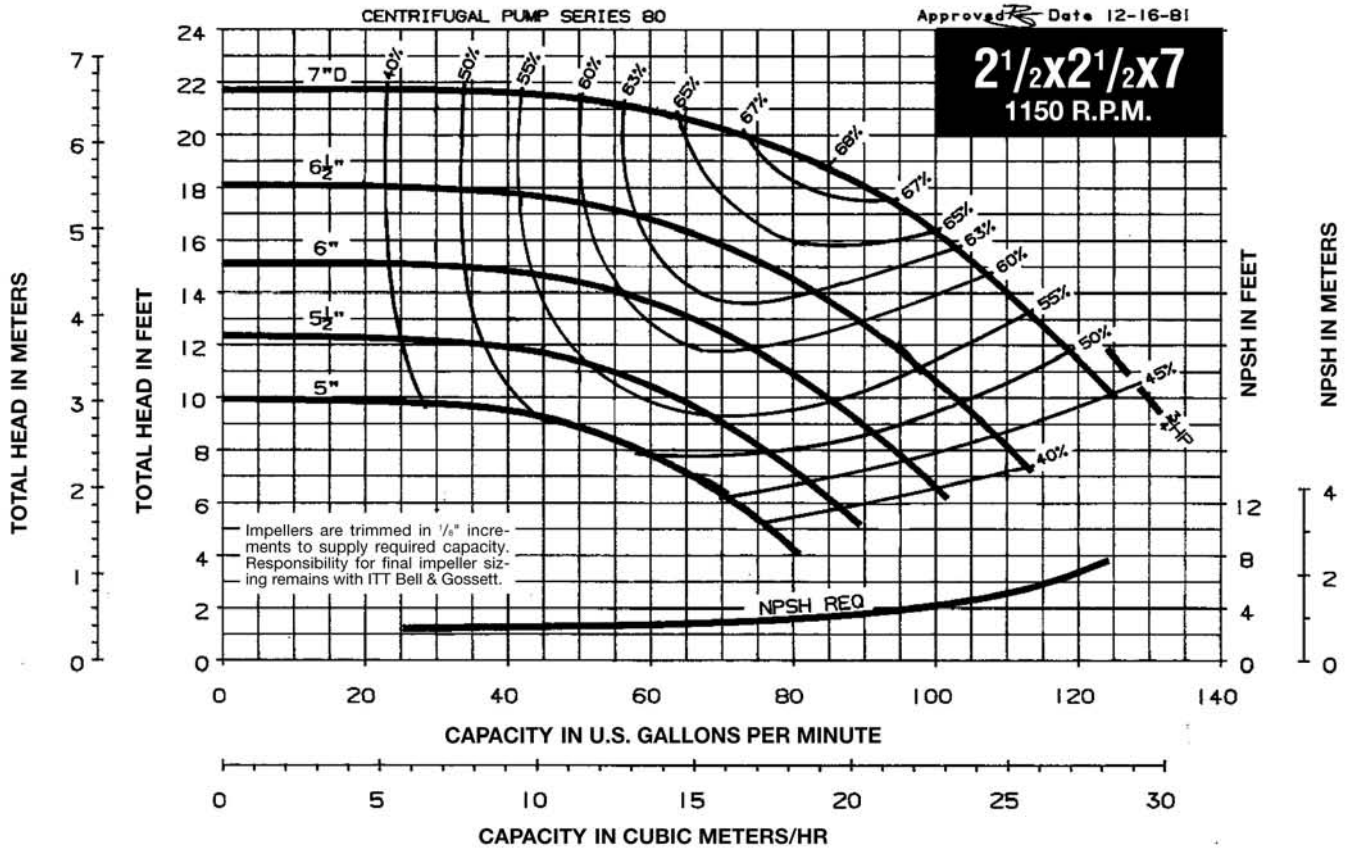

SERIES 80 STANDARD PUMPS

1150 RPM PUMP CURVES

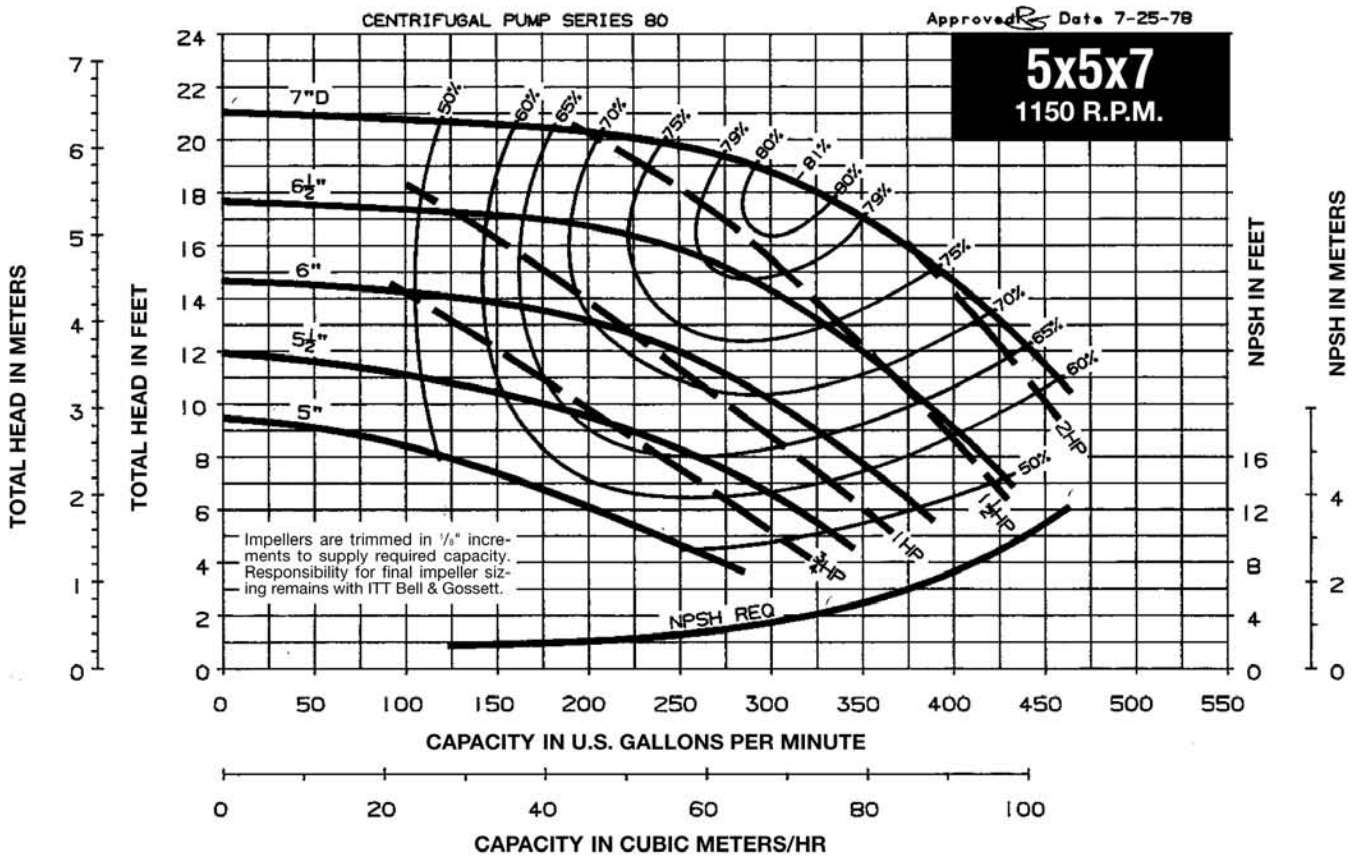
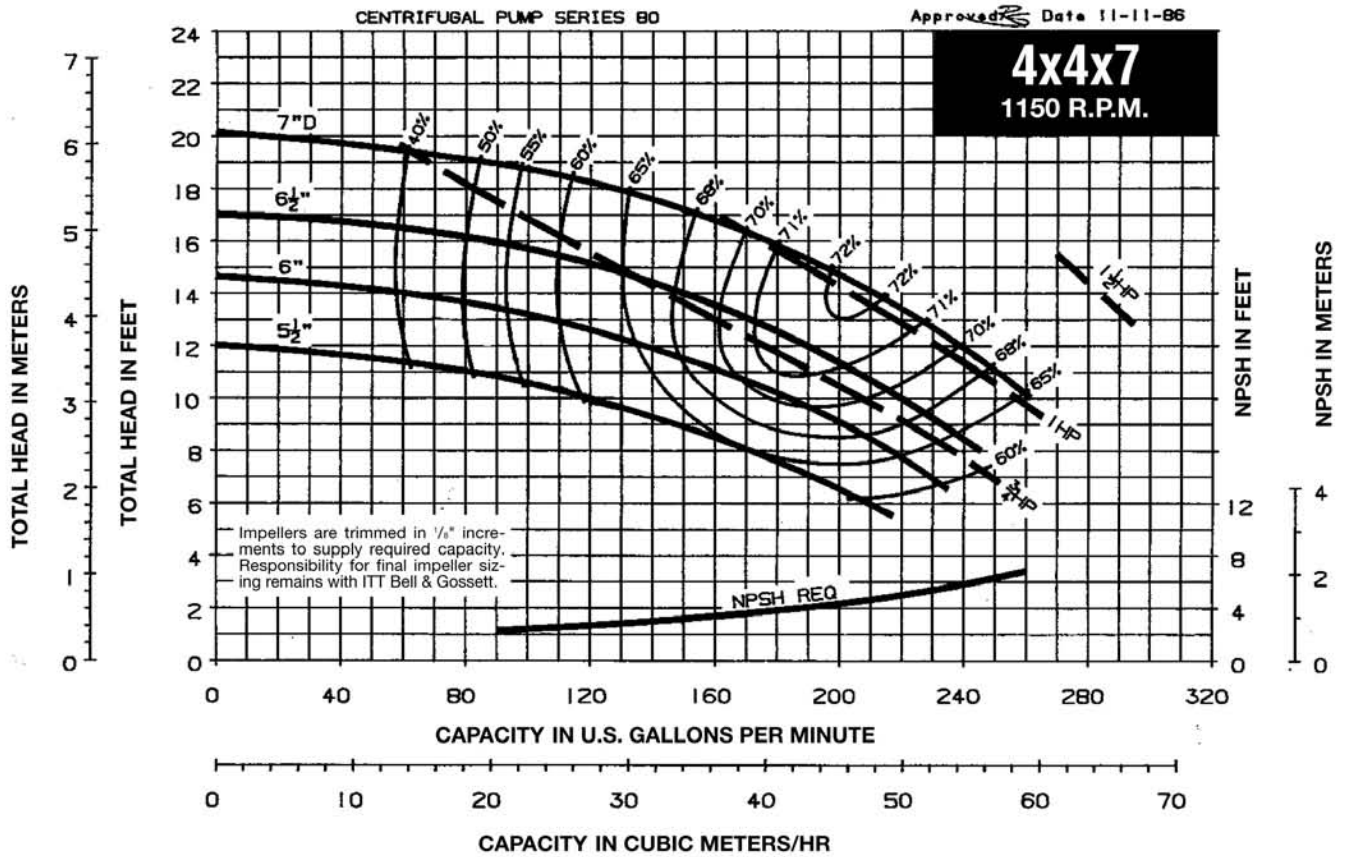

SERIES 80 STANDARD PUMPS

1150 RPM PUMP CURVES

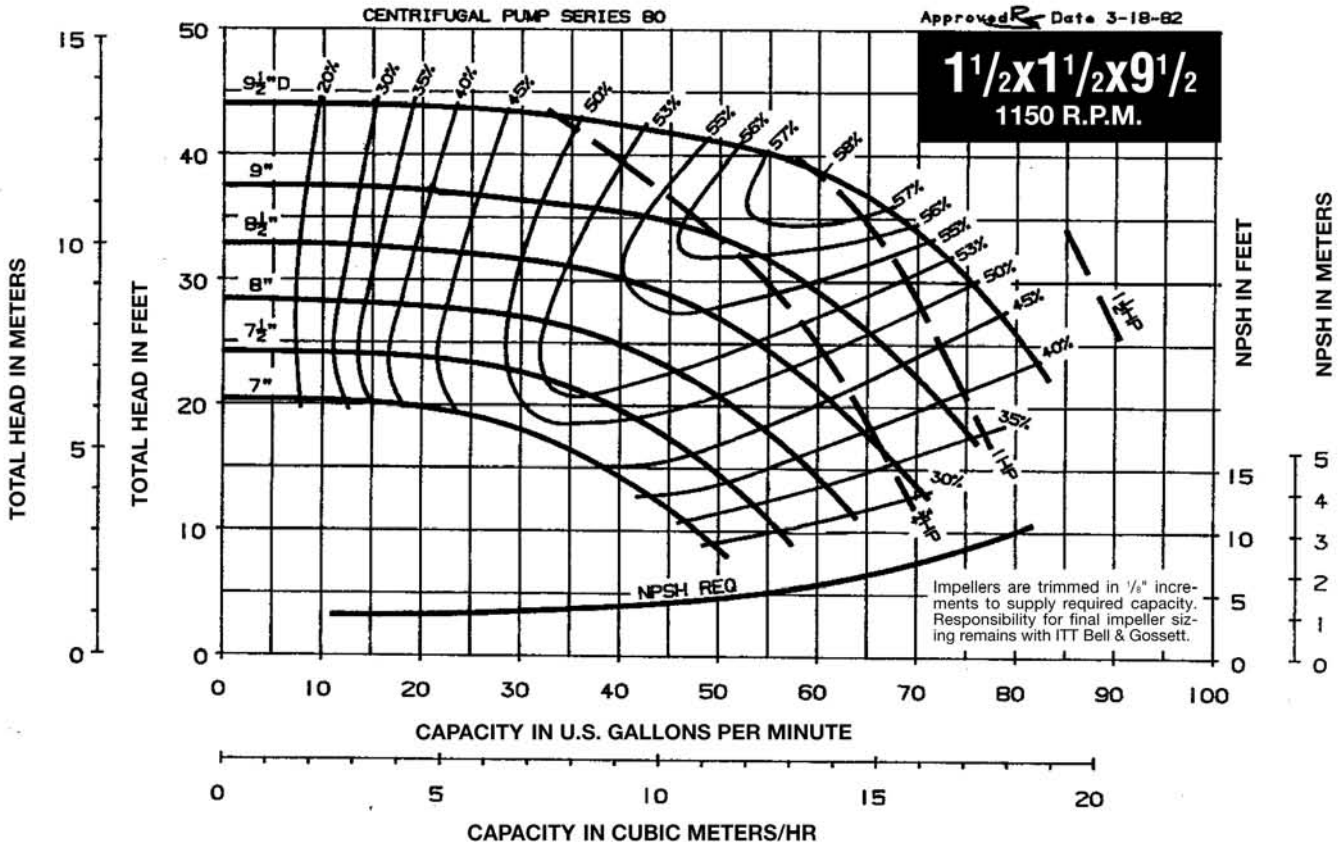
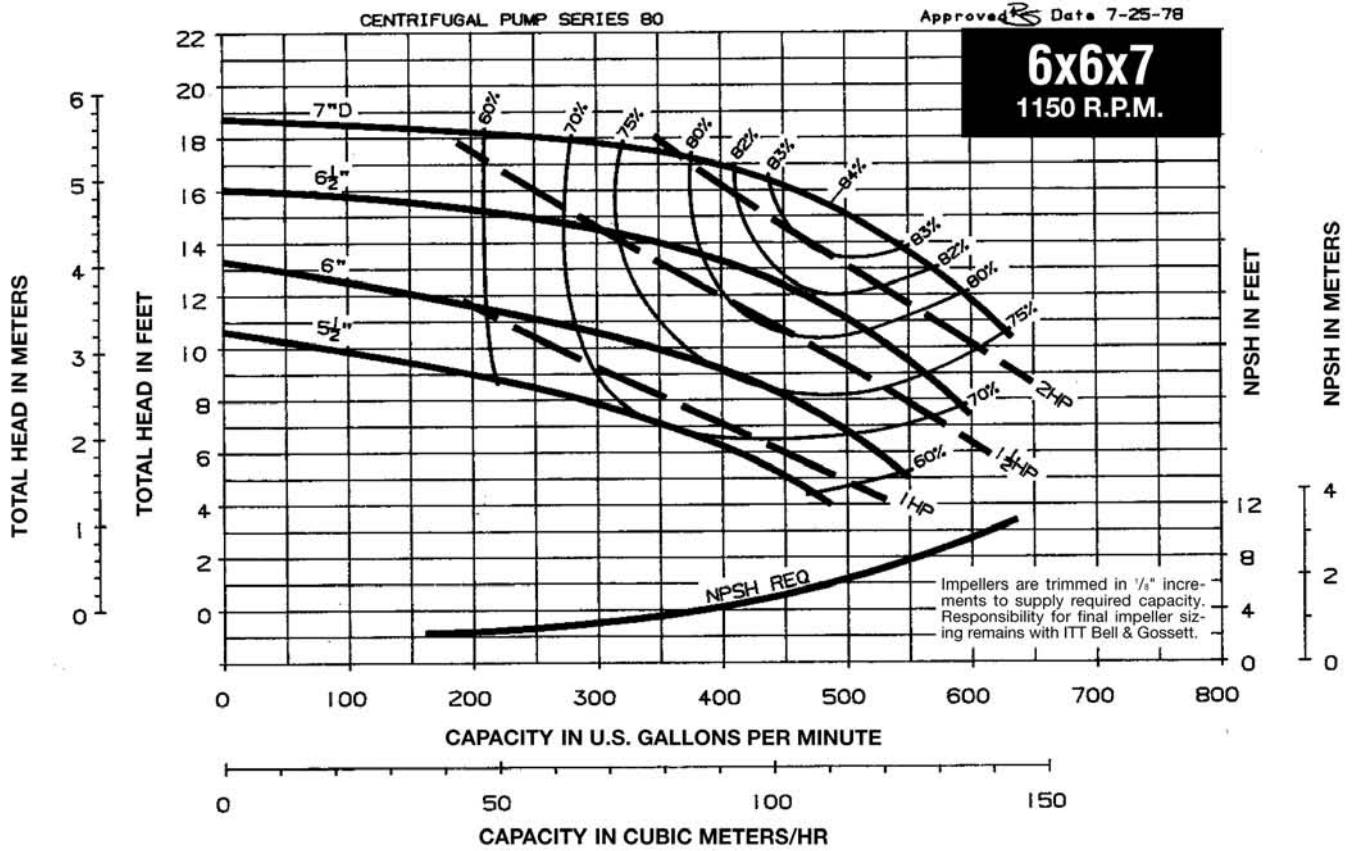

SERIES 80 STANDARD PUMPS

1150 RPM PUMP CURVES

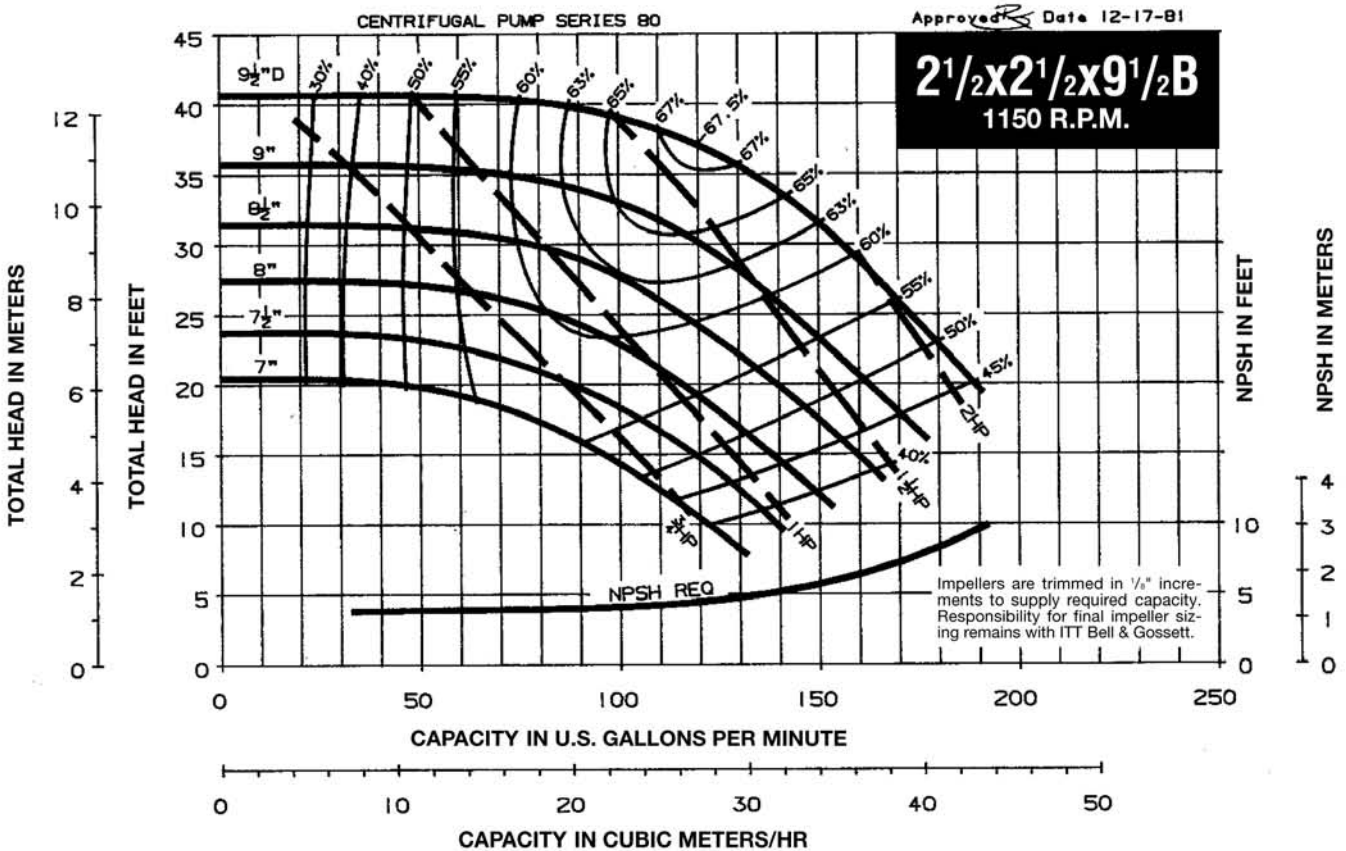
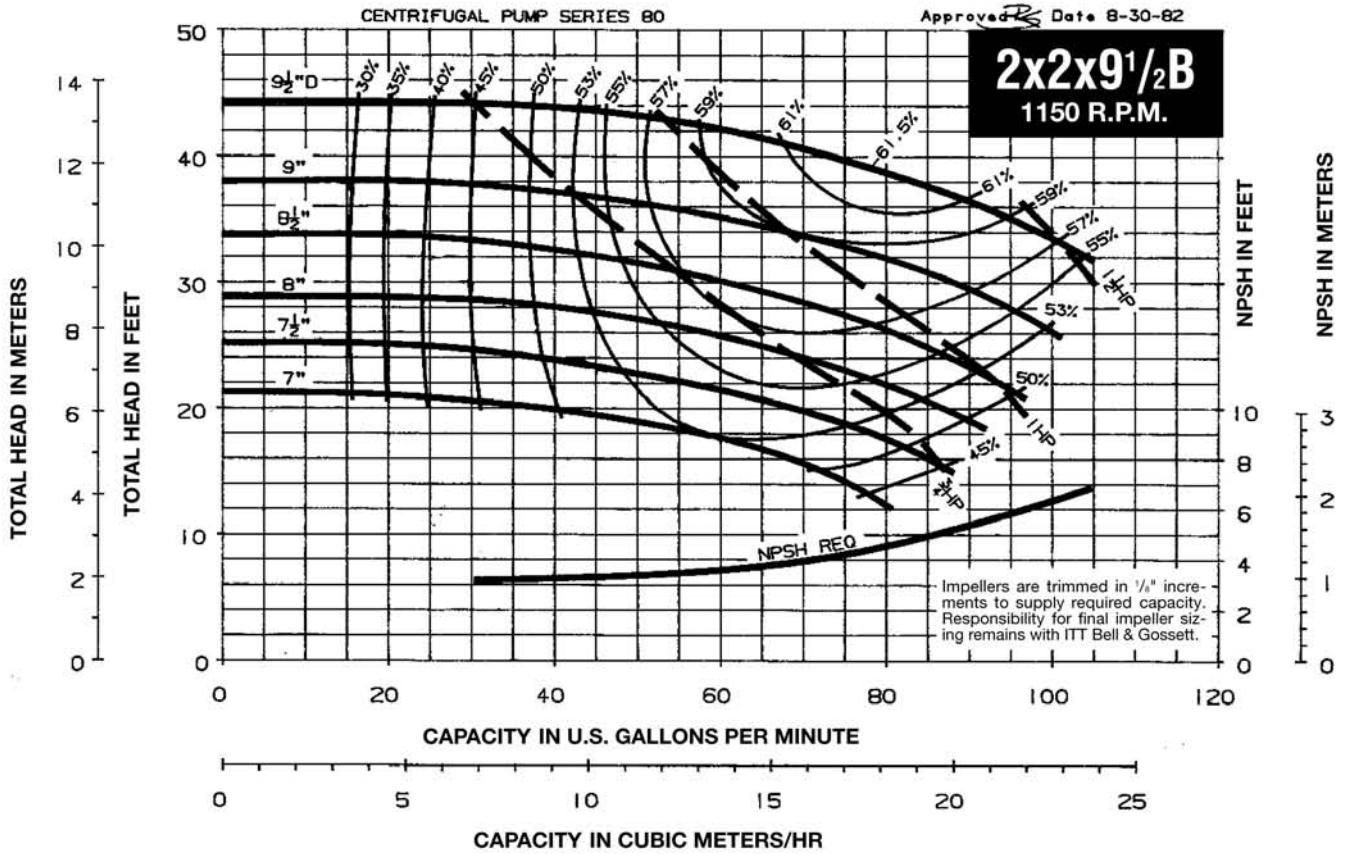

SERIES 80 STANDARD PUMPS

1150 RPM PUMP CURVES

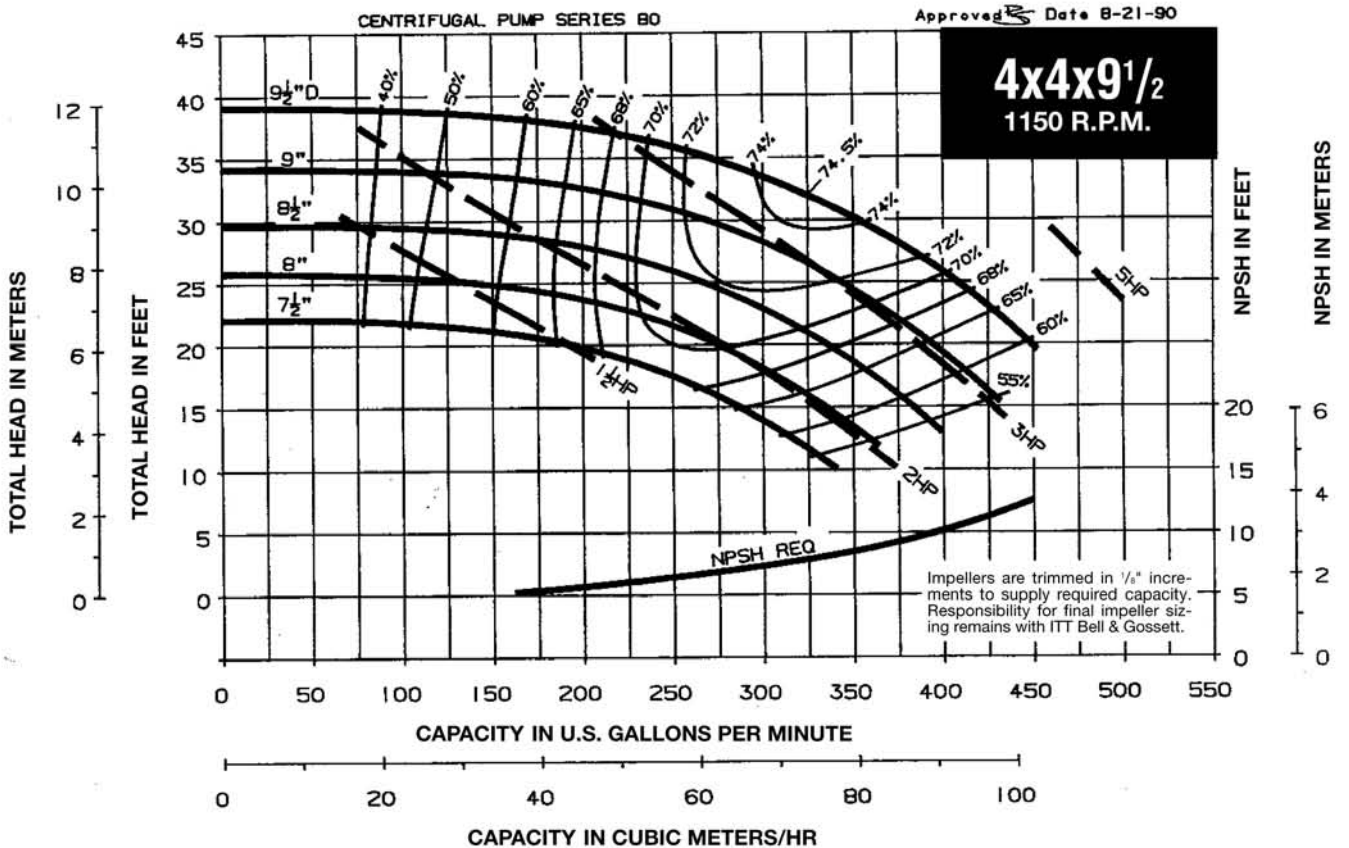
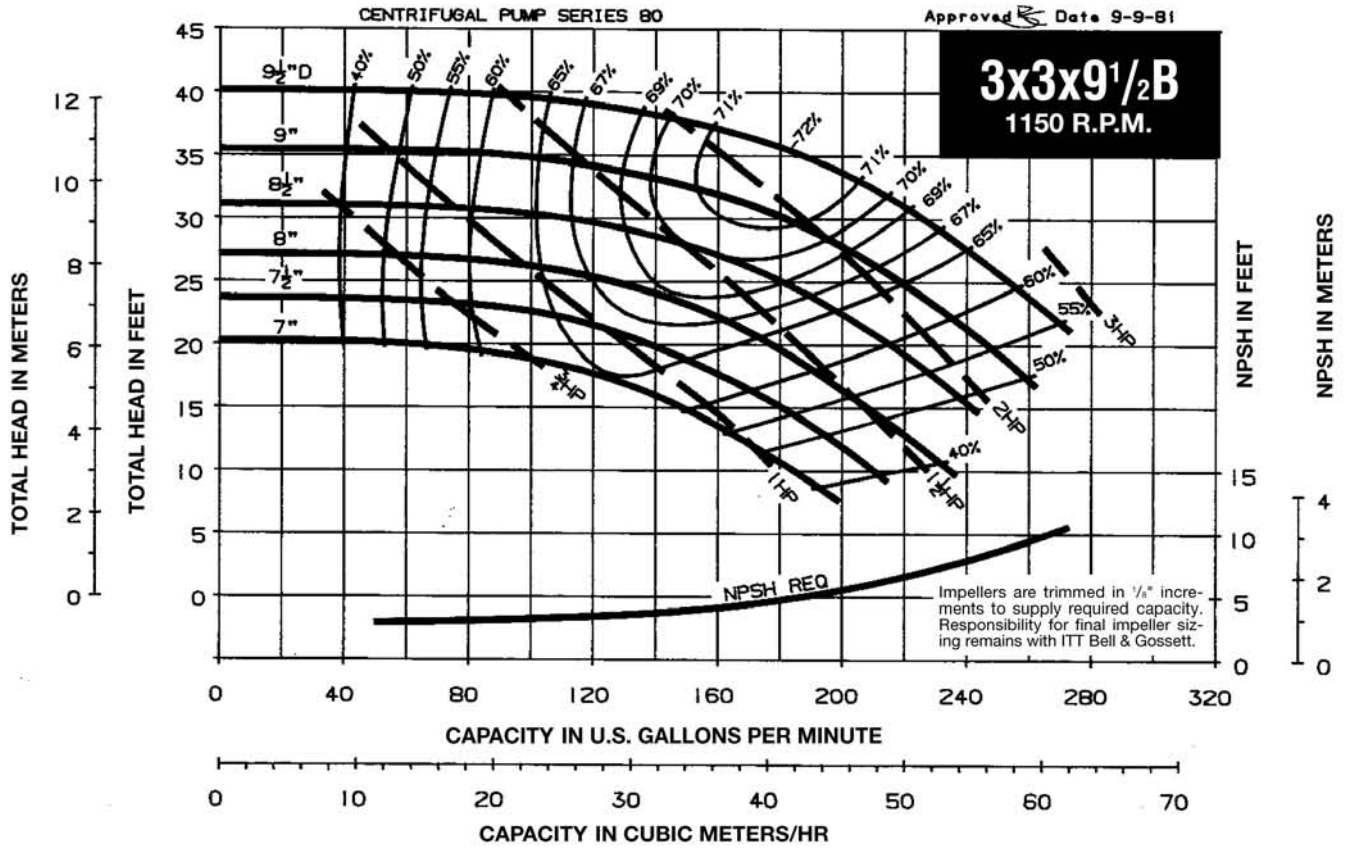

SERIES 80 STANDARD PUMPS

1150 RPM PUMP CURVES

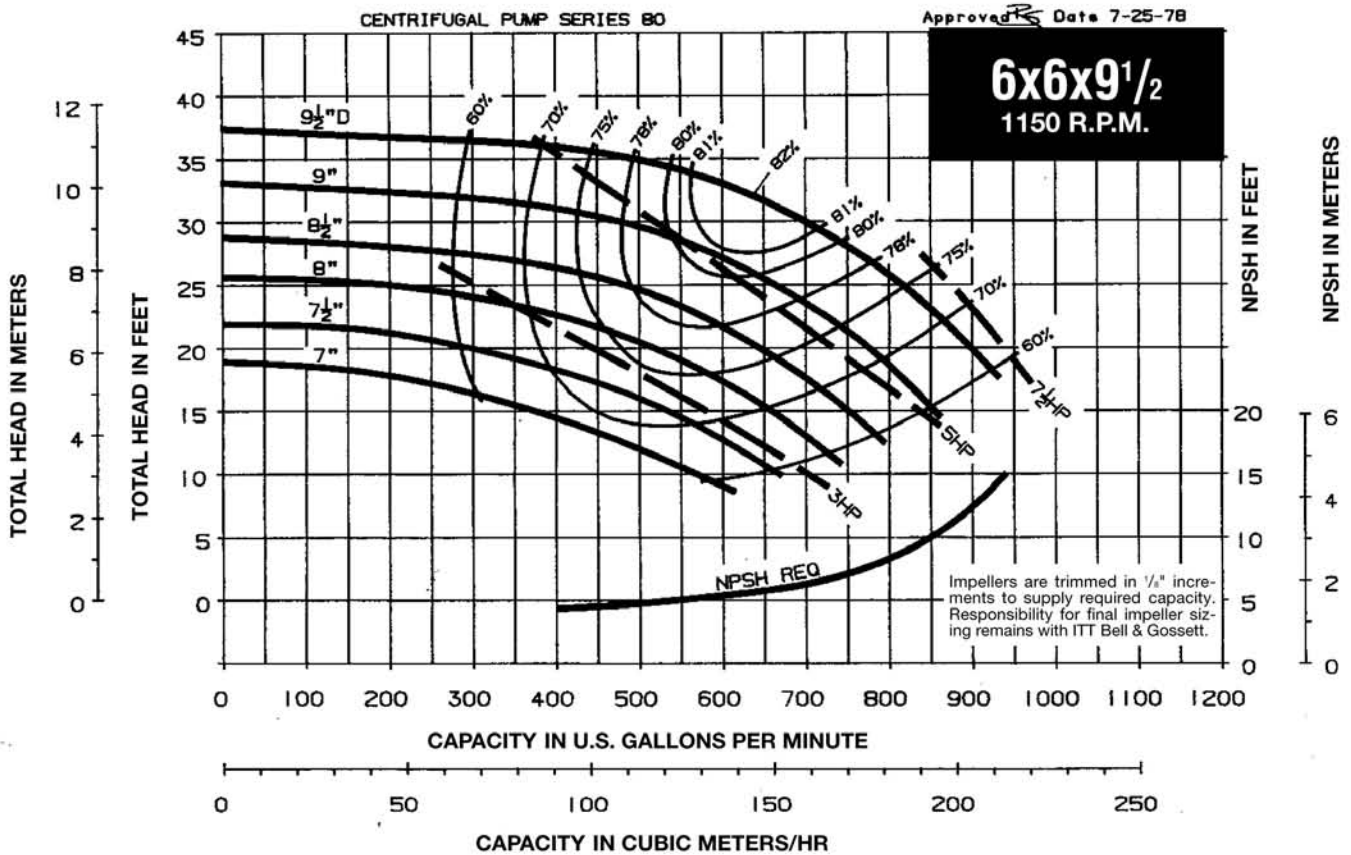
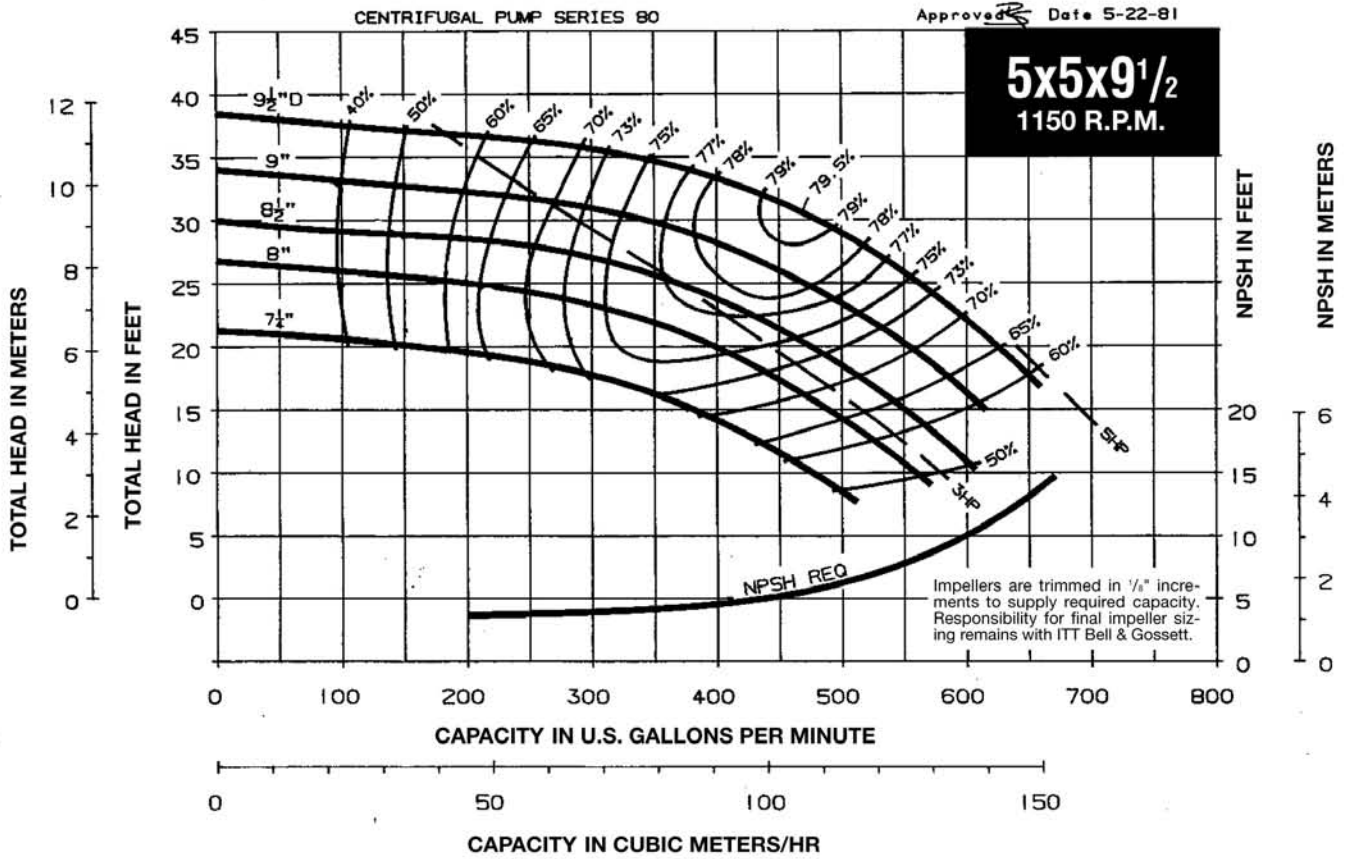

SERIES 80 STANDARD PUMPS

1150 RPM PUMP CURVES

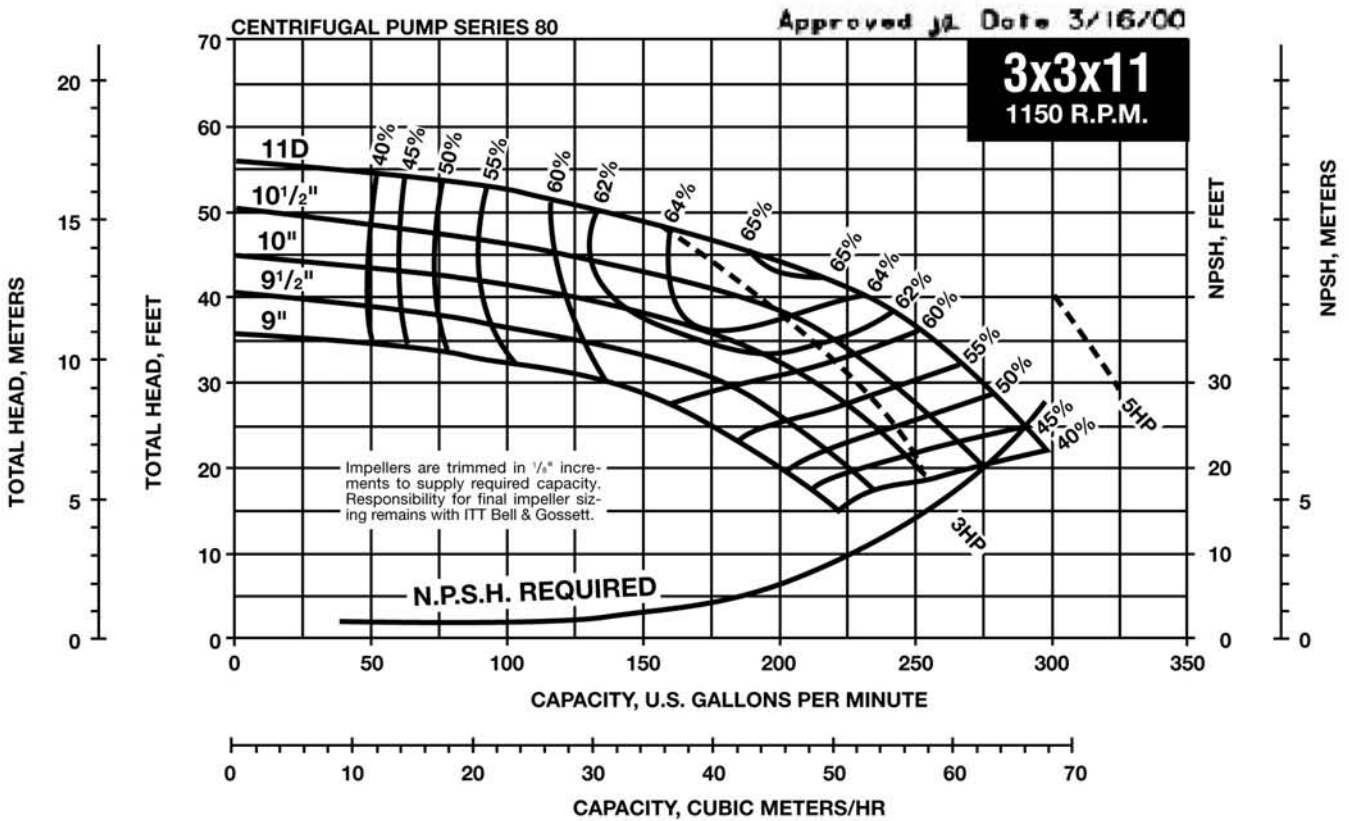
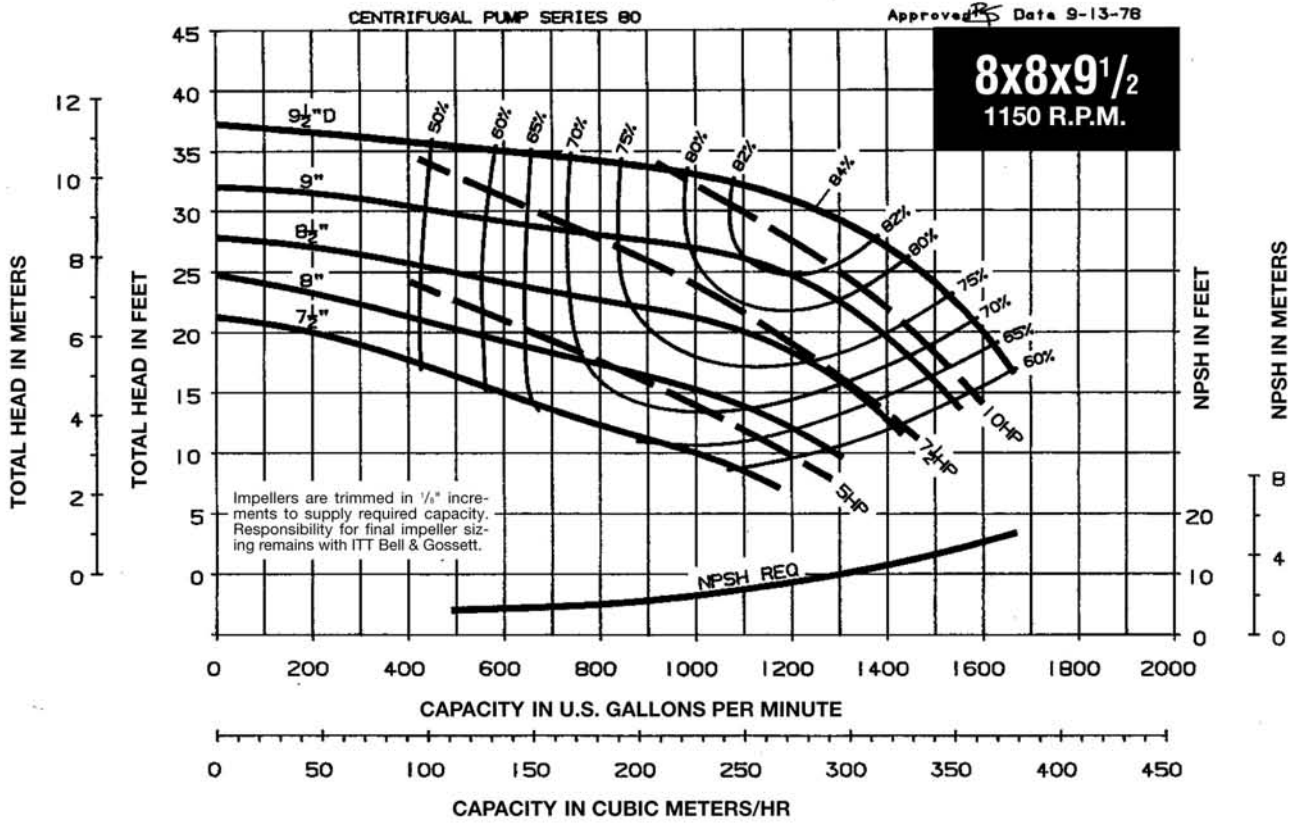

SERIES 80 STANDARD PUMPS

1150 RPM PUMP CURVES

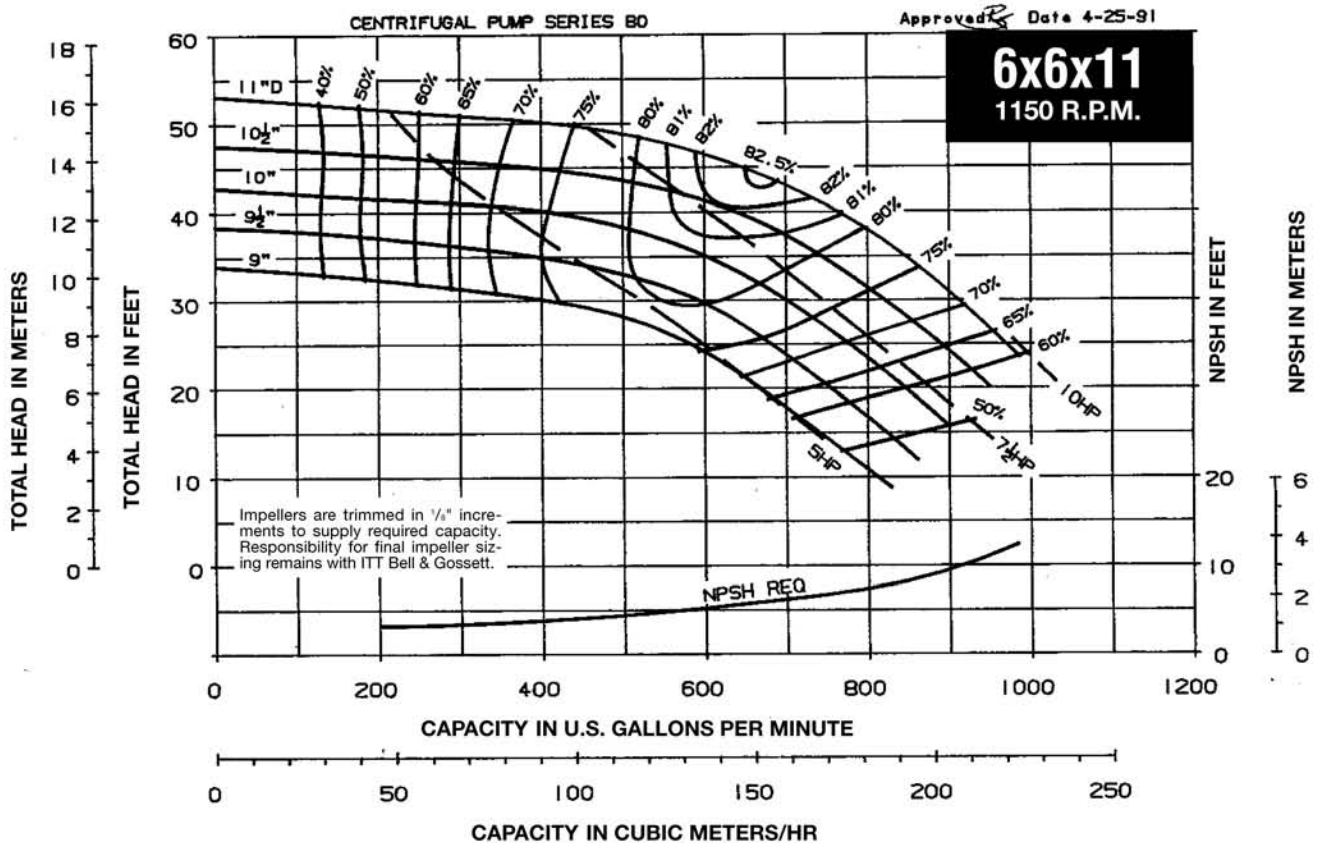
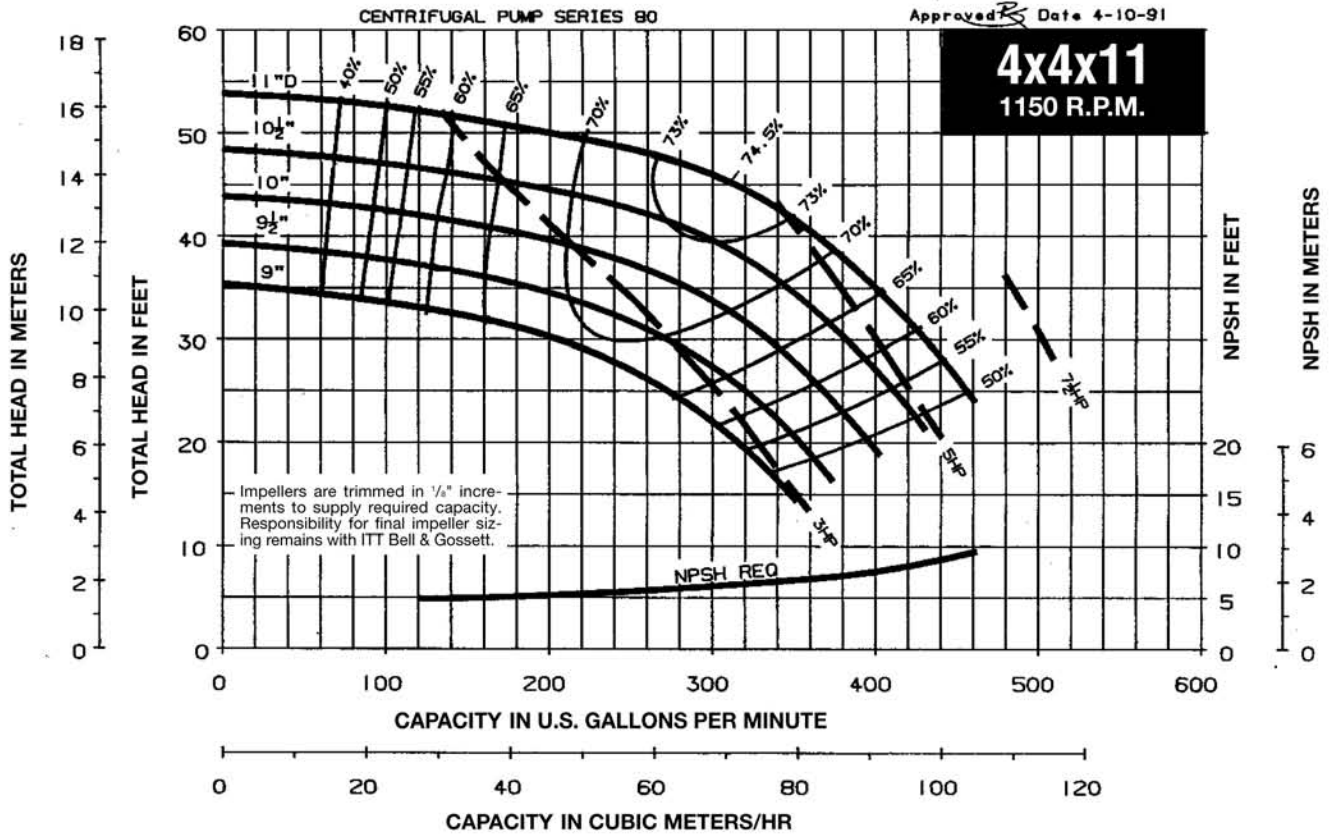

SERIES 80 STANDARD PUMPS

1150 RPM PUMP CURVES

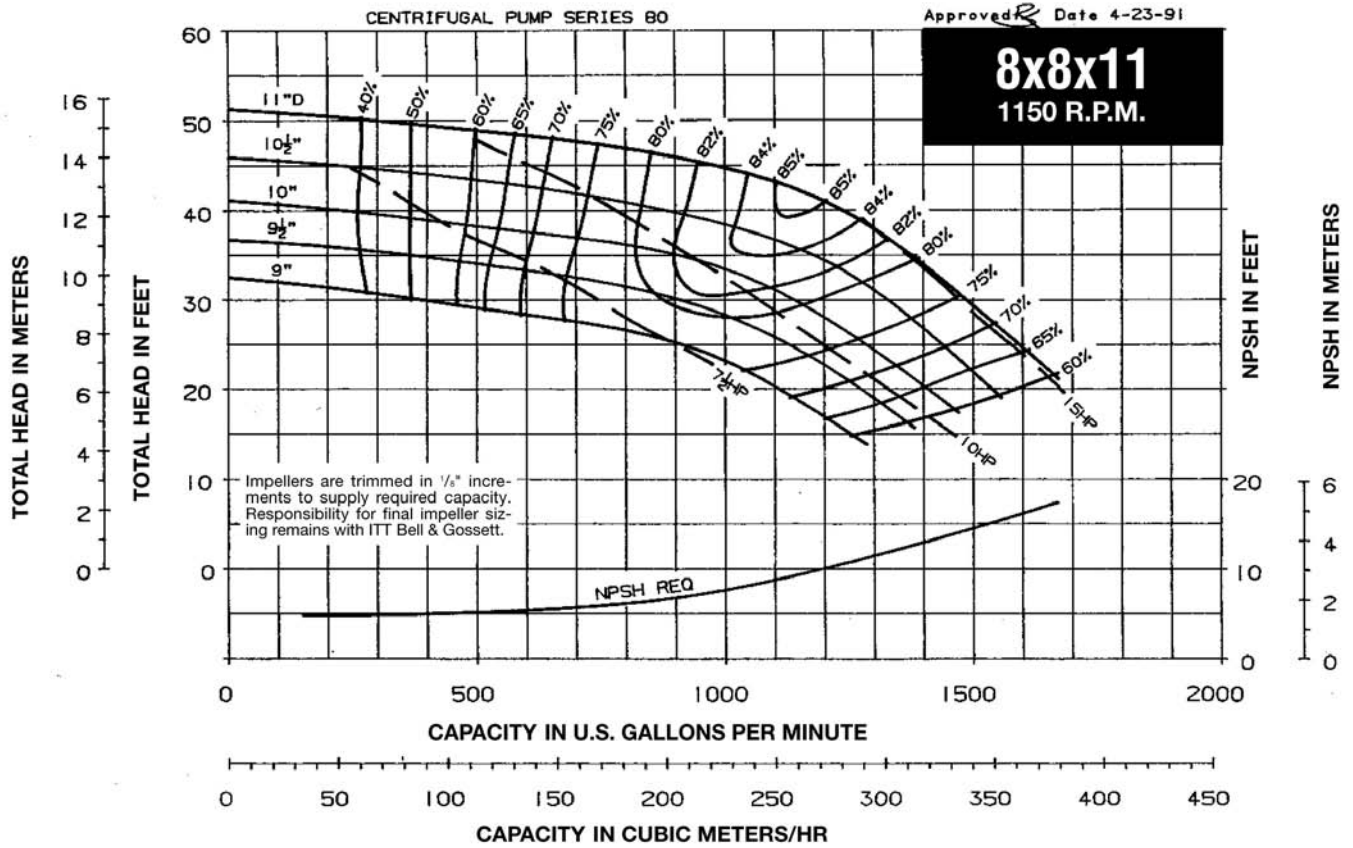

SERIES 80 STANDARD PUMPS

NOTES

SERIES 80 STANDARD PUMPS

NOTES

Xylem Inc.

8200 N. Austin Avenue, Morton Grove, Illinois 60053

Phone: (847) 966-3700 Fax: (847) 965-8379

www.xyleminc.com/brands/bellgossett



Bell & Gossett

a xylem brand