

Revisions:	No:	Date:	Description:
	01	8-18-2016	BOH cmts addressed

Date: 6/21/2016
Drawn: TJH
Checked:
Sheet Title:

EQUIPMENT DATA & PIPING SCHEMATIC

Drawing No.

PL-1.4

Sheet No.
8 of 8

POOL EQUIPMENT LEGEND

QTY	DESCRIPTION
1	TR140 SAND FILTER BY PENTAIR
1	WHISPERFLO 3HP PUMP XFE-8 HIGH EFFICIENCY
1	FULL FLOW MULTI-PORT BACKWASH VALVE (TO ACCEPT 3" PIPING)
2	9" MAIN DRAIN SLUMP AND GRATE ASSEMBLY (NSF AND VGB COMPLIANT)
1	2.5" BLUE-WHITE IMPACT FLOW METER
1	RAINBOW CHLORINATOR MODEL #320 BY PENTAIR
8	SP1419D HAYWARD 3/4" DIRECTIONAL EYEBALL
7	STA-RIT FLOOR INLET ASSEMBLY
2	HAY-25-1504 SP1022S INLET SLIP FITTING
2	U-3 SKIMMER
2	EQUALIZER SUCTION OUTLET COVER (NSF AND VGB COMPLIANT)
1	POOL MISER
2	TRUE-UNION BALL VALVES FOR PIPE SIZE 3" AND SMALLER
	SCH 40 PVC PIPE FOR ALL SUCTION, RETURN, AND EQUIPMENT ROOM PIPING
1	1.90" O.D. HANDRAIL DMS-102 DECK MOUNTED
1	4 TREAD STAINLESS STEEL ECONOMY LADDER
1	TAYLOR TEST KIT K-2005 (DPO METHOD OF TESTING FOR CHLORINE RESIDUALS)
4	4" 1.90" WEDGE ANCHORS FOR HANDRAIL AND LADDER
1	1.90" O.D. ESCUTCHEONS FOR HANDRAIL AND LADDER
	1"X1 WATERLINE TILE (SEE HARDSCAPE PLAN FOR COLOR AND STYLE)
	2X2 KEYSTONE TILE FOR STEPS AND UNDERWATER BENCHES (SEE HARDSCAPE PLAN)
	6X6 DEPTH MARKERS, 4" BLACK LETTERING ON WHITE BACKGROUND (SLIP RESISTANT FINISH)
	6X6 INTERNATIONAL "NO DIVING" SYMBOL
	WHITE PLASTER

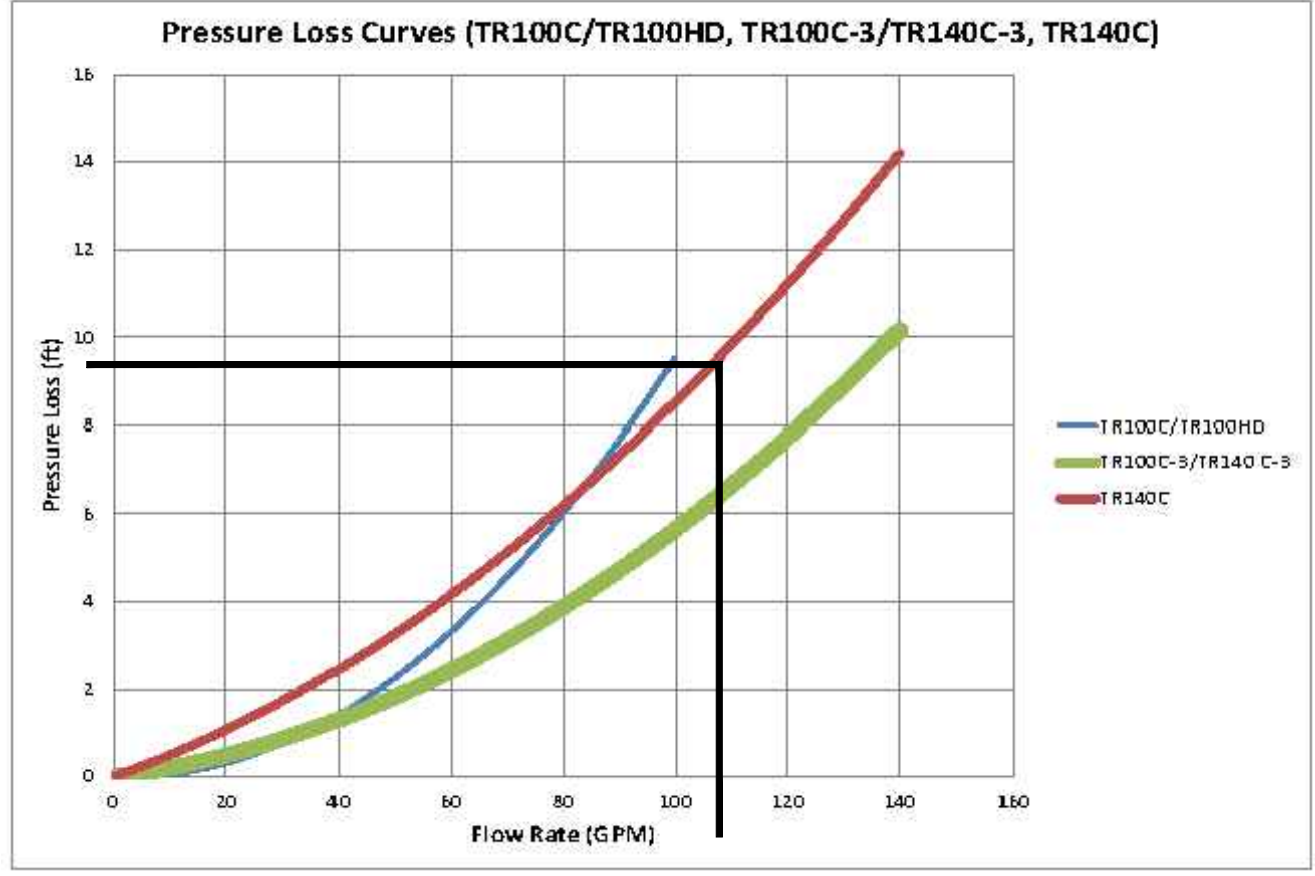

06 SAND FILTER PERFORMANCE CURVE
PL-1.3 SCALE: NOT TO SCALE

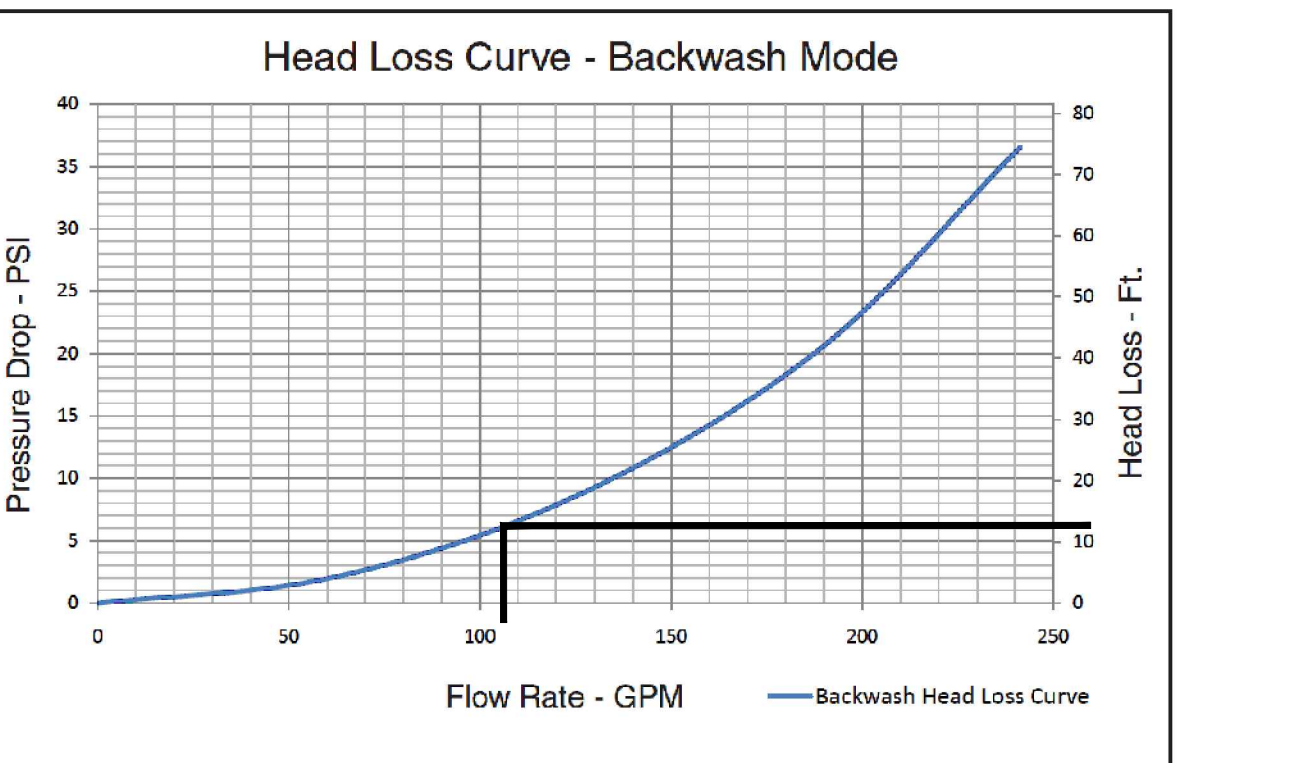

07 HI-FLO VALVE PERFORMANCE CURVE
PL-1.3 SCALE: NOT TO SCALE

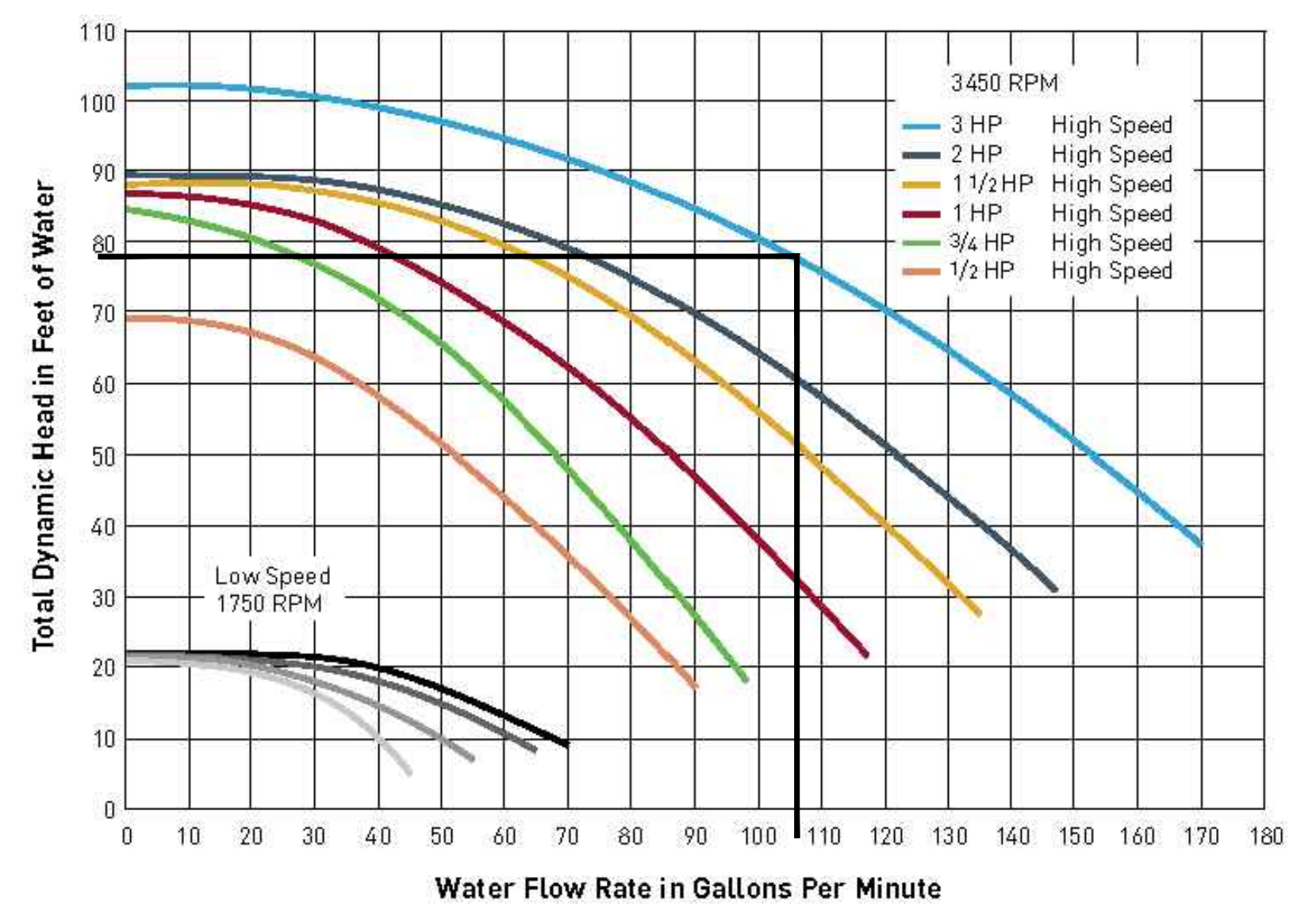

08 RECIRCULATION PUMP PERFORMANCE CURVE
PL-1.3 SCALE: NOT TO SCALE

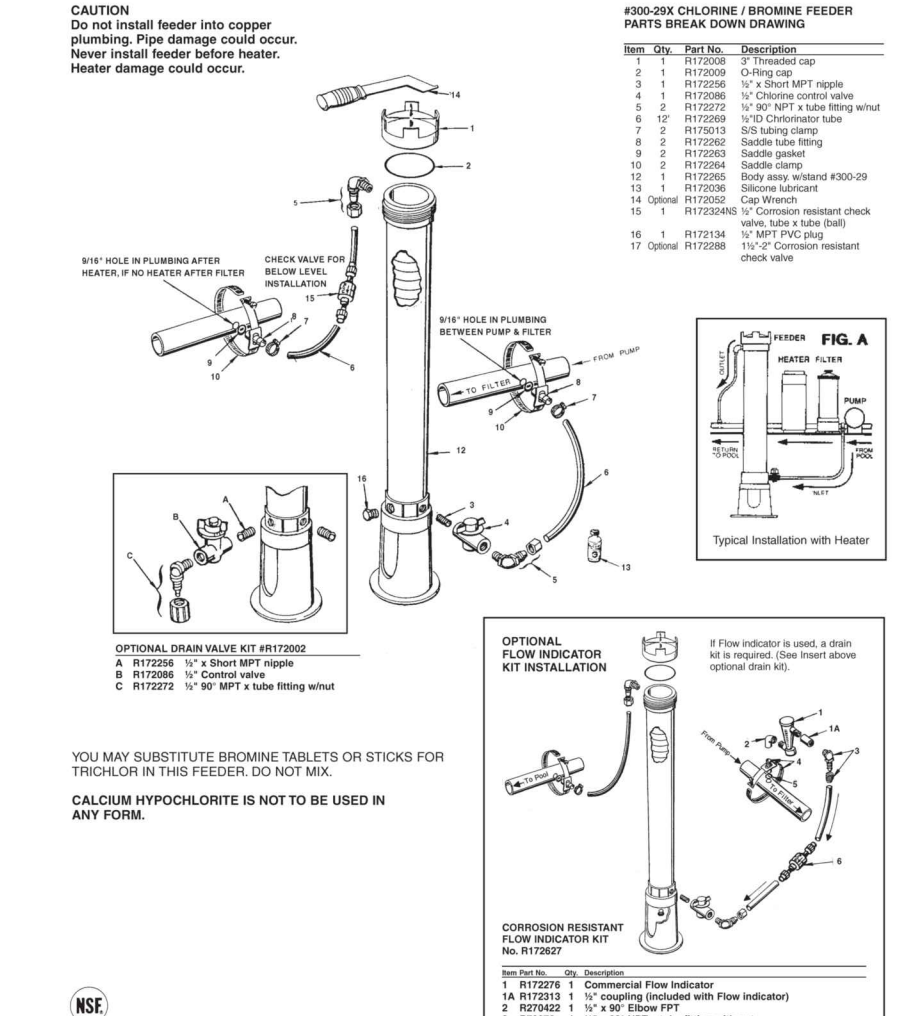
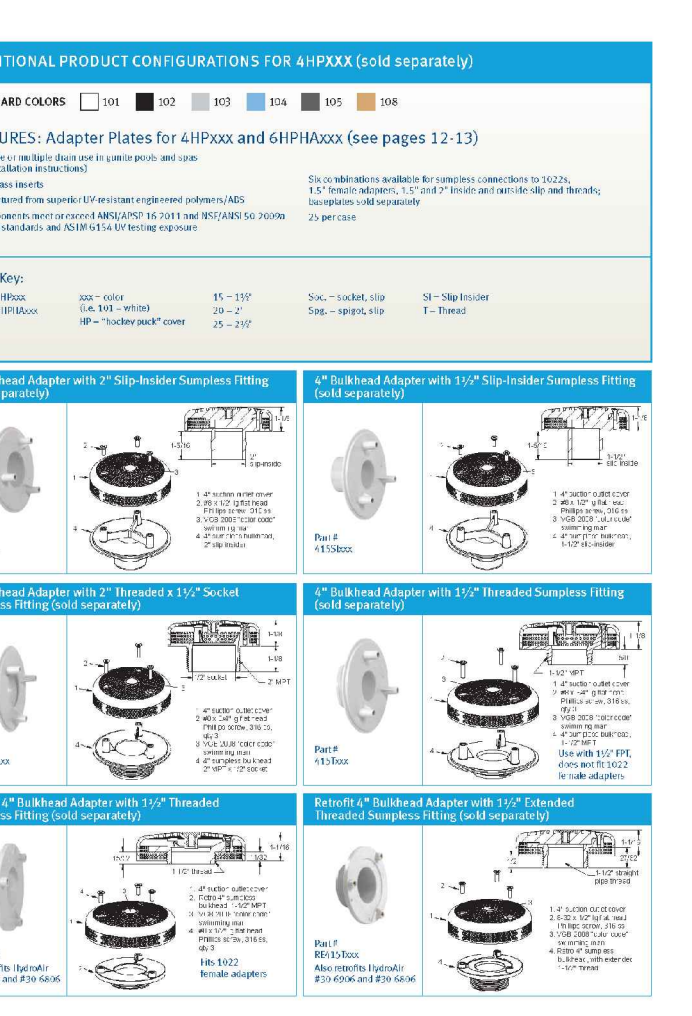
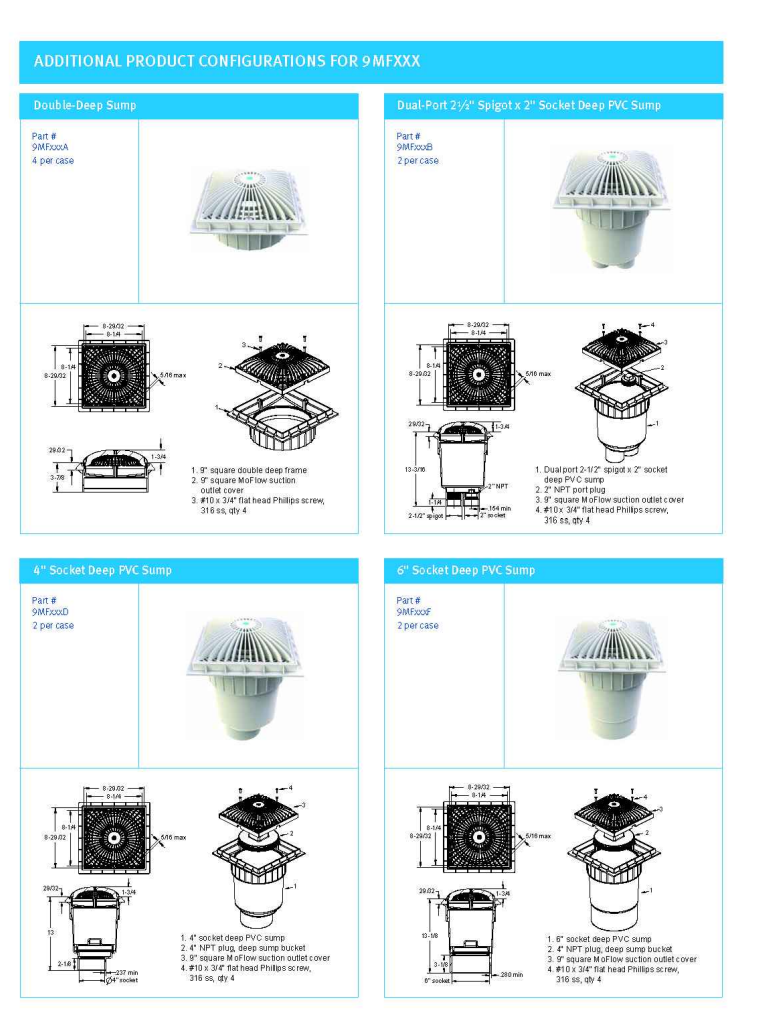
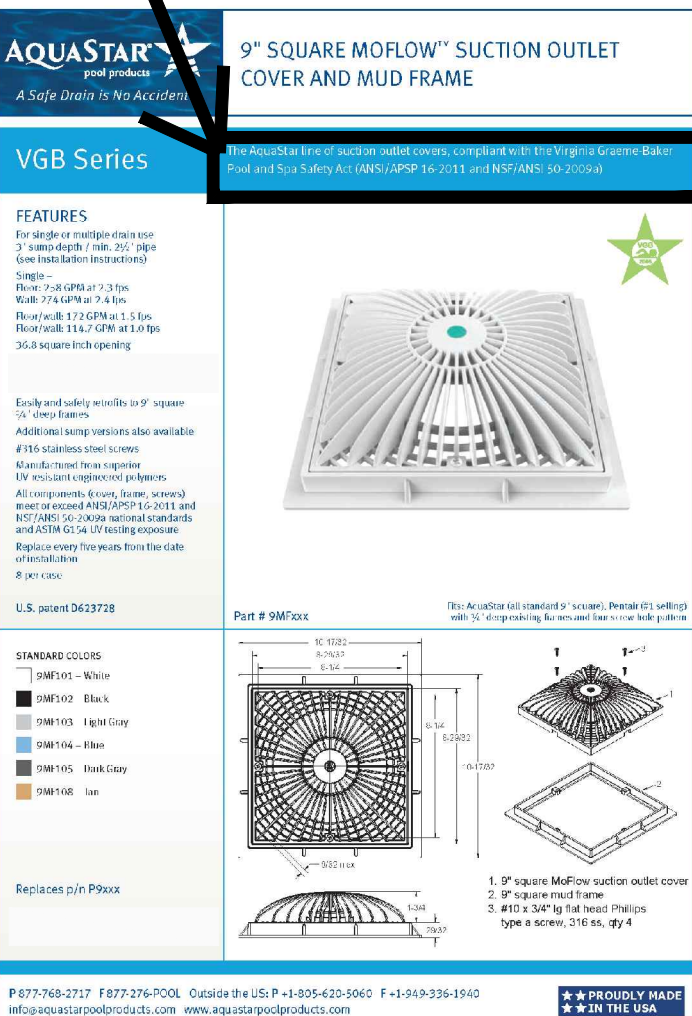
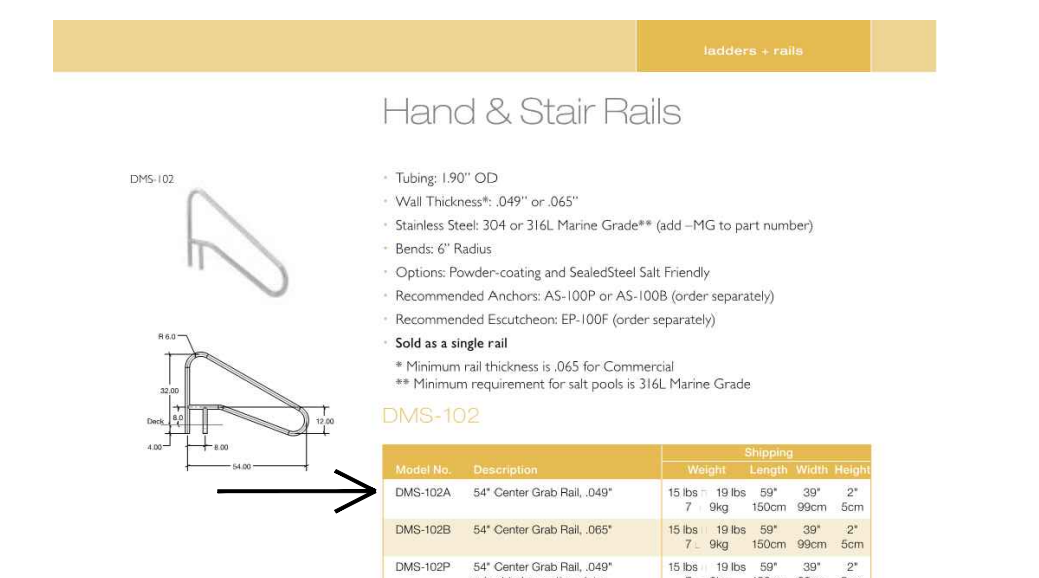
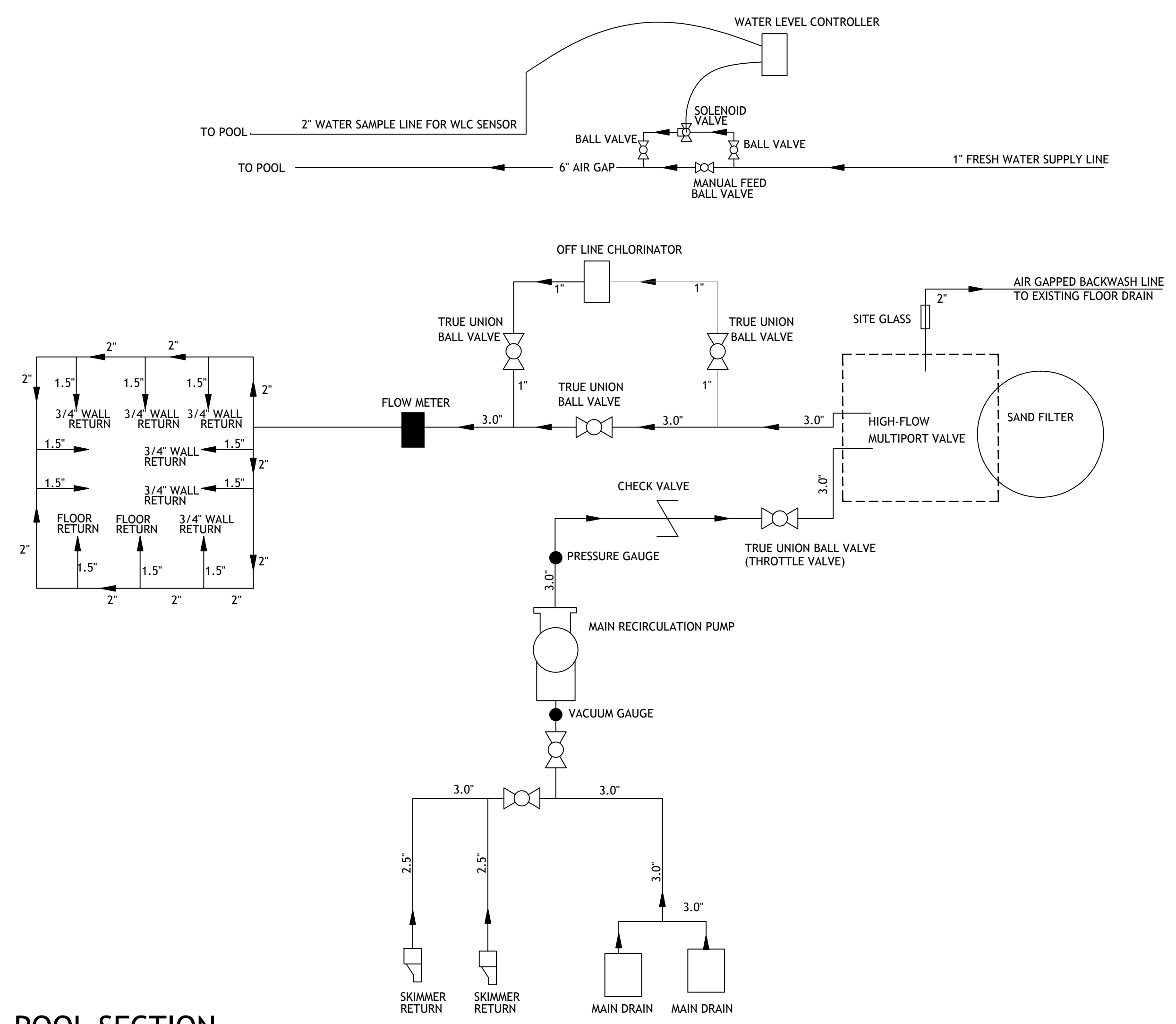

NOTE: THE MAIN DRAIN COVER SHALL BE WHITE, AND FRAME SHALL BE BLACK TO PROVIDE FOR A DARK COLORED CONTRASTING BAND AROUND THE MAIN DRAIN COVER.

NOTE: THE SKIMMER EQUALIZER COVER SHALL BE WHITE AND THE FRAME PLATE SHALL BE BLACK; FORMING A DARK CONTRASTING COLOR AROUND THE COVER.