

SPECIFICATIONS

S-1

GENERAL

Sink bowls seamlessly drawn of heavy-gauge, nickel-bearing stainless steel.

DESIGN FEATURES

Bowl Depth: 6".

Faucet Deck: Raised.

Bowl Finish: Sink bowls are polished to a buffed finish.

Underside: Sound deadened on bottom only.

Self Rim: Sink shall be furnished with the appropriate number of clamps to provide a secure, watertight installation.

OTHER

Drain opening: 3-1/2".

Faucet Holes: 3 or 4 faucet holes, 4" center to center.

Note: Unless otherwise specified, sink is furnished with four faucet holes.



Model K-23322-4 Shown

Complies with ANSI Standard A112.19.3.



These sinks are listed by the International Association of Plumbing and Mechanical Officials as meeting the requirements of the Uniform Plumbing Code.

SINK DIMENSIONS

| Model No. | Overall L | Overall W | Inside Bowl L | Inside Bowl W | Inside Bowl D | Number Faucet Openings | Cutout In Countertop 1/4" Radius Corners | Ship. Wt. Lbs. |
|-----------|-----------|-----------|---------------|---------------|---------------|------------------------|--|----------------|
| K-23321 | 33 | 21 1/4 | 14 | 15 3/4 | 6 | 3 or 4 | 32 3/4" x 20 5/8" | 11 1/4 |
| K-23322 | 33 | 22 | 14 | 15 3/4 | 6 | 3 or 4 | 32 3/4" x 21 3/8" | 12 |
| K6-23321 | 33 | 21 1/4 | 14 | 15 3/4 | 6 | 3 or 4 | 32 3/4" x 20 5/8" | 63 |
| K6-23322 | 33 | 22 | 14 | 15 3/4 | 6 | 3 or 4 | 32 3/4" x 21 3/8" | 65 |
| K50-23321 | 33 | 21 1/4 | 14 | 15 3/4 | 6 | 3 or 4 | 32 3/4" x 20 5/8" | 516 |
| K50-23322 | 33 | 22 | 14 | 15 3/4 | 6 | 3 or 4 | 32 3/4" x 21 3/8" | 523 |

NOTE: Four faucet holes standard unless otherwise specified.
K-Prefix sinks are packed one per shipping carton.
K6-Prefix sinks are nested six per shipping carton.
K50-Prefix sinks are nested 50 per shipping carton.

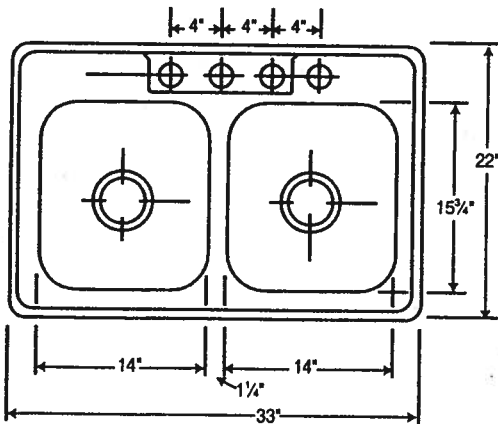

Bowl Depth is 6"
Model K-23322-4 Illustrated

ALL DIMENSIONS IN INCHES. TO CONVERT TO MILLIMETERS MULTIPLY BY 25.4.

In keeping with our policy of continuing product improvement, Elkay reserves the right to change product specifications without notice.

This specification describes an Elkay product with design, quality and functional benefits to the user. When making a comparison of other producers' offerings, be certain these features are not overlooked.

Elkay Manufacturing Company

www.elkay.com

2222 Camden Court
Oak Brook, IL 60523

Printed in U.S.A.
©1998 Elkay Mfg. Co.

(Rev. 10/98) 2-19C

TWO-HANDLE KITCHEN FAUCETS

PT9201

Two-Knob Handle Kitchen Faucet

STANDARD SPECIFICATIONS

- Single-handle kitchen deck faucets for exposed mountings.
- 8" long spout swings 360°.
- 8" centers.
- Hot and cold stems are interchangeable.
- Control mechanism shall be of the rotating cylinder type with stainless steel plate and 180° rotation, with replaceable non-metallic seats operating in stainless steel lined sockets.
- 1/2" - 14 NPSM threaded male inlet shanks.

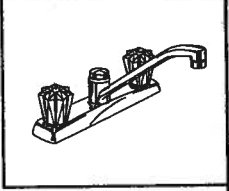
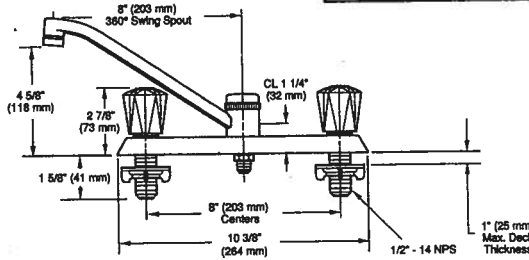

PRODUCTS MEET THE FOLLOWING STANDARDS AND SPECIFICATIONS:

- ASME A112.18.1
- CSA B125
- IAPMO Listed
- CSA Certified
- UL Classified to NSF-61



PT9202

Two-Blade Handle Kitchen Faucet

STANDARD SPECIFICATIONS

- Single-handle kitchen deck faucets for exposed mountings.
- 8" long spout swings 360°.
- 8" centers.
- Hot and cold stems are interchangeable.
- Control mechanism shall be of the rotating cylinder type with stainless steel plate and 180° rotation, with replaceable non-metallic seats operating in stainless steel lined sockets.
- 1/2" - 14 NPSM threaded male Inlet shanks.

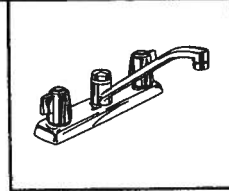
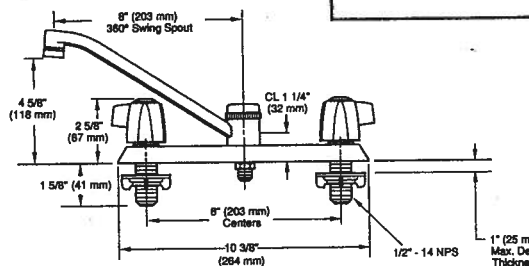

PRODUCTS MEET THE FOLLOWING STANDARDS AND SPECIFICATIONS:

- ASME A112.18.1
- CSA B125
- ICC/ANSI A117.1/ADA
- IAPMO Listed
- CSA Certified
- UL Classified to NSF-61



PT9501

Two-Knob Handle Kitchen Faucet

STANDARD SPECIFICATIONS

- Single-handle kitchen deck faucets for exposed mountings.
- 8" long spout swings 360°.
- 8" centers.
- Hot and cold stems are interchangeable.
- Control mechanism shall be of the rotating cylinder type with stainless steel plate and 180° rotation, with replaceable non-metallic seats operating in stainless steel lined sockets.
- Models with spray attachment have anti-siphon device as integral part of the valve body.
- 1/2" - 14 NPSM threaded male Inlet shanks.

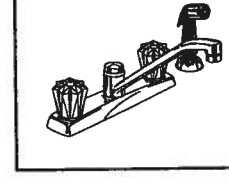
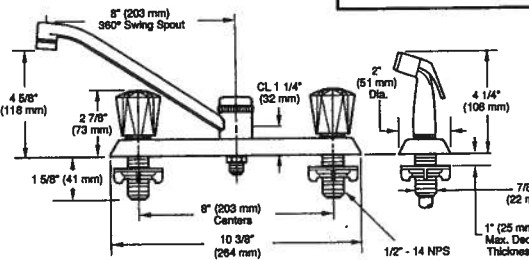

PRODUCTS MEET THE FOLLOWING STANDARDS AND SPECIFICATIONS:

- ASME A112.18.1
- CSA B125
- IAPMO Listed
- CSA Certified
- UL Classified to NSF-61



PT9502

Two-Blade Handle Kitchen Faucet

STANDARD SPECIFICATIONS

- Single-handle kitchen deck faucets for exposed mountings.
- 8" long spout swings 360°.
- 8" centers.
- Hot and cold stems are interchangeable.
- Control mechanism shall be of the rotating cylinder type with stainless steel plate and 180° rotation, with replaceable non-metallic seats operating in stainless steel lined sockets.
- Models with spray attachment have anti-siphon device as integral part of the valve body.
- 1/2" - 14 NPSM threaded male inlet shanks.

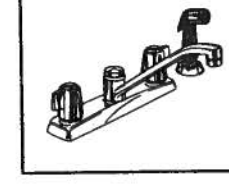
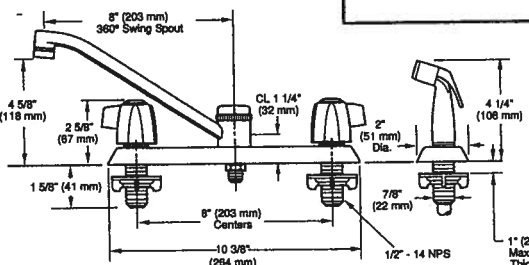

PRODUCTS MEET THE FOLLOWING STANDARDS AND SPECIFICATIONS:

- ASME A112.18.1
- CSA B125
- ICC/ANSI A117.1/ADA
- IAPMO Listed
- CSA Certified
- UL Classified to NSF-61



IMPORTED STRAINERS



4½" SINK STRAINER

A STAINLESS STEEL STRAINER DESIGNED FOR COMMERCIAL INSTALLATIONS, MOBILE HOMES, SHOWER STALLS, PUBLIC HOUSING, ETC. FEATURES A SNAP-IN GRID PLATE.

| FIGURE NO | DESCRIPTION | PCS. PER SHELF PACK | PCS. PER MASTER CARTON | WT. PER MASTER CARTON | LIST PRICE |
|-----------|-------------------|---------------------|------------------------|-----------------------|------------|
| 2-5-3 | 4½" Sink Strainer | 1 | 50 | 31 | 7.38 |

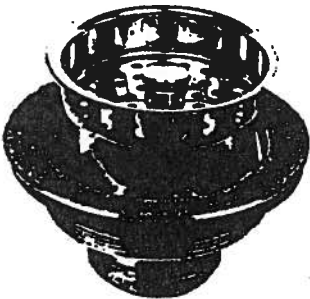

CAST BRASS DUO STRAINER

CAST BRASS DUO SINK STRAINER. HIGHLY POLISHED CHROME PLATED. BRASS LOCKNUT AND BRASS SLIPNUT. STAINLESS STEEL BASKET

| | | | | | |
|-------|--------------------------|---|----|----|-------|
| 2-8-3 | Cast Brass Sink Strainer | 1 | 50 | 67 | 17.45 |
|-------|--------------------------|---|----|----|-------|



DUO SINK STRAINER

ALL STAINLESS STEEL STRAINER & BASKET. DEEP CUT 14 PITCH LOCKNUT THREADS. CHROME PLATED STEM.

| | | | | | |
|-------|-------------------|---|----|----|------|
| 2-9-3 | Duo Sink Strainer | 1 | 50 | 31 | 6.41 |
|-------|-------------------|---|----|----|------|

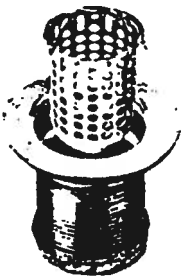

DEEP JUNIOR DUO STRAINER

A STAINLESS STEEL DEEP JUNIOR DUO STRAINER. HIGHLY POLISHED AND CHROME PLATED DEEP BAIL BASKET. DESIGNED FOR SINKS WITH 2½" DRAIN OPENINGS. PERFECT FOR BAR SINKS, MOBILE HOMES, ETC.

| | | | | | |
|------|--------------------------|---|----|----|-------|
| 2-10 | Deep Junior Duo Strainer | 1 | 50 | 36 | 12.77 |
|------|--------------------------|---|----|----|-------|

Rough Brass Stops

COMPRESSION INLET - COMPRESSION OUTLET

VALVES PACKED 60 OR 125 PER CARTON

| <u>Part Num.</u> | <u>Description</u> | <u>Inlet</u> | <u>Outlet</u> |
|------------------|--------------------|------------------|------------------|
| Angle | | | |
| A211 | CR1B | 3/8" Nom. Compr. | 3/8" O.D. Compr. |
| A213 | CR3B | 3/8" Nom. Compr. | 1/2" O.D. Compr. |
| A212DIM | CR09 / C40 | 1/2" Nom. Compr. | 1/4" O.D. Compr. |
| A212 | CR19 / C60 | 1/2" Nom. Compr. | 3/8" O.D. Compr. |
| A214 | CR39 / C80 | 1/2" Nom. Compr. | 1/2" O.D. Compr. |

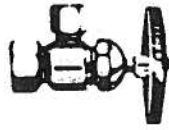

Straight

| | | | |
|------|------------|------------------------------------|------------------|
| A227 | OCR11/C66S | 3/8" O.D. Compr. (or 1/4" Nom.) | 3/8" O.D. Compr. |
| A225 | OCR3A | 3/8" Nom. Compr. | 1/2" O.D. Compr. |
| A224 | OCR14/C60S | 1/2" Nom. Compr. | 3/8" O.D. Compr. |
| A226 | OCR34/C80S | 1/2" Nom. Compr. | 1/2" O.D. Compr. |



F.I.P. INLET - COMPRESSION OUTLET

| Angle | | | |
|--------------|------------|-------------|-----------------------------|
| A200 | R15 / 63C | 3/8" F.I.P. | 3/8" O.D. Compr. |
| A202 | R35 / 83C | 3/8" F.I.P. | 1/2" O.D. Compr. |
| A201DIM | R07 | 1/2" F.I.P. | 1/4" O.D. Compr. |
| A201 | R17 / 64C | 1/2" F.I.P. | 3/8" O.D. Compr. |
| A203 | R37 / 84C | 1/2" F.I.P. | 1/2" O.D. Compr. |
| A901 | 3301 / 74R | 1/2" F.I.P. | 1/2" & 7/16" O.D. Compr. |



Straight

| | | | |
|------|-------------|-------------|------------------|
| A215 | OR10 / 63CS | 3/8" F.I.P. | 3/8" O.D. Compr. |
| A217 | OR30 / 83CS | 3/8" F.I.P. | 1/2" O.D. Compr. |
| A216 | OR12 / 64CS | 1/2" F.I.P. | 3/8" O.D. Compr. |
| A218 | OR32 / 84CS | 1/2" F.I.P. | 1/2" O.D. Compr. |

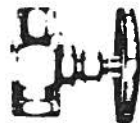

Fluidyne Ansonia

1 Riverside Drive, Ansonia, CT 06401
 Phone (203) 735-9311 Fax (203) 735-3489



Polybutylene Riser Tubes

Cat. Num. Description Size Length Pack List

Lavatory



| | | | | | |
|--------|--------|-----------|-----|-----|--|
| A400PL | P1-12A | 3/8" O.D. | 12" | 100 | |
| A401PL | P1-15A | 3/8" O.D. | 15" | 100 | |
| A402PL | P1-20A | 3/8" O.D. | 20" | 100 | |
| A403PL | P1-30A | 3/8" O.D. | 30" | 50 | |
| A404PL | P1-36A | 3/8" O.D. | 36" | 50 | |
| A405PL | P3-12A | 1/2" O.D. | 12" | 50 | |
| A406PL | P3-20A | 1/2" O.D. | 20" | 50 | |

| |
|--|
| |
| |
| |
| |
| |
| |
| |

Closet



| | | | | | |
|--------|---------|-----------|-----|-----|--|
| A420PL | P1-12DL | 3/8" O.D. | 12" | 100 | |
| A415PL | P1-15PL | 3/8" O.D. | 15" | 50 | |
| A421PL | P1-20DL | 3/8" O.D. | 20" | 50 | |
| A422PL | P3-12DL | 1/2" O.D. | 12" | 50 | |
| A423PL | P3-20DL | 1/2" O.D. | 20" | 50 | |

| |
|--|
| |
| |
| |
| |
| |
| |

POLY FERRULES

Size Description Pack List

| | | | | |
|--------|-----------|--------------|-----|--|
| A700PL | 1/4" O.D. | Poly Ferrule | 100 | |
| A701PL | 3/8" O.D. | Poly Ferrule | 100 | |
| A703PL | 1/2" O.D. | Poly Ferrule | 100 | |
| A705PL | 5/8" O.D. | Poly Ferrule | 100 | |

| |
|--|
| |
| |
| |
| |

plastic tubular products

continuous waste
end outlet



| BLACK | WHITE | DESCRIPTION | PAC. PER CARTON | WT. PER CARTON | LIST PRICE EACH |
|----------|----------|--|-----------------|----------------|-----------------|
| *A44-806 | *P44-806 | 16" Slip Joint | 30 | 12 | |
| *A44-810 | *P44-810 | 21" Slip Joint | 15 | 14 | |
| A44-820 | P44-820 | 25" Slip Joint | 15 | 16 | |
| A50-800 | P50-800 | 16" Direct Connection | 15 | 12 | |
| A50-810 | P50-810 | 21" Direct Connection | 15 | 14 | |
| | | *For Universal Slip/direct Connection Specify "U" After Last Digit and Add | | | |

continuous waste
center outlet

1/2"
w/BAFFLE TEE



| | | | | | |
|----------|----------|--|----|----|--|
| *A53-800 | *P53-800 | 16" Slip Joint | 15 | 13 | |
| *A53-810 | *P53-810 | 21" Slip Joint | 15 | 14 | |
| A56-800 | P56-800 | 16" Direct Connection | 15 | 13 | |
| A56-810 | P56-810 | 21" Direct Connection | 15 | 14 | |
| | | *For universal slip/direct connection specify "U" after last digit | | | |

telescopic
continuous waste



| | | | | | |
|---------|---------|------------|----|----|--|
| A51-800 | P51-800 | End Outlet | 45 | 32 | |
|---------|---------|------------|----|----|--|

telescopic
disposer kit

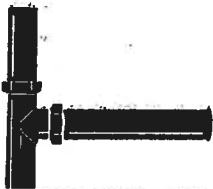

| | | | | | |
|---------|---------|--------------|----|----|--|
| A52-800 | P52-800 | Disposer Kit | 40 | 30 | |
|---------|---------|--------------|----|----|--|

disposer kits

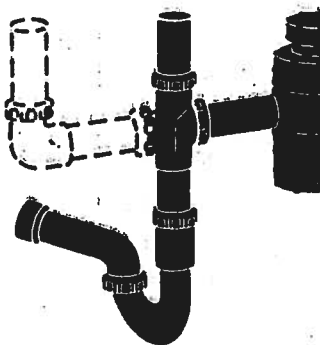

| | | END OUTLET | | | |
|----------|----------|---|----|----|--|
| A57-800 | P57-800 | 1-1/2" Trap to Wall 1-1/2" x 6" Sink Tailpiece 1-1/2" x 14" Sink Tailpiece 1-1/2" E.O. Tee & Tailpiece | 15 | 16 | |
| A57-800L | P57-800L | 1-1/2" x 6" Sink Tailpiece 1-1/2" x 14" Sink Tailpiece 1-1/2" E.O. Tee & Tailpiece | 15 | 10 | |
| | | CENTER OUTLET | | | |
| A58-800 | P58-800 | 1-1/2" Trap to Wall 1-1/2" x 7" Waste Arm 1-1/2" x 6" Sink Tailpiece 1-1/2" x 8" Sink Tailpiece 1-1/2" C.O. Tee & Tailpiece | 15 | 16 | |
| A58-800L | P58-800L | 1-1/2" x 7" Waste Arm 1-1/2" x 6" Sink Tailpiece 1-1/2" x 8" Sink Tailpiece 1-1/2" C.O. Tee & Tailpiece | 15 | 10 | |

VANETTE LAVATORY

Product Features:

- Acid-resisting enamel steel
- Front overflow
- Self-rimming
- Two soap depressions
- Mounting clamps supplied
- Shown with 2000. Series Ceramix Centerset faucet (not included)

3003.605

faucet holes on 102mm (4") centers (illustrated)

Nominal Dimensions: 483mm (19")

Bowl sizes:

381mm (15") wide, 279mm (11") front to back,
152mm (6") deep

Fixture Dimensions conform to ANSI Standard
A112.19.4

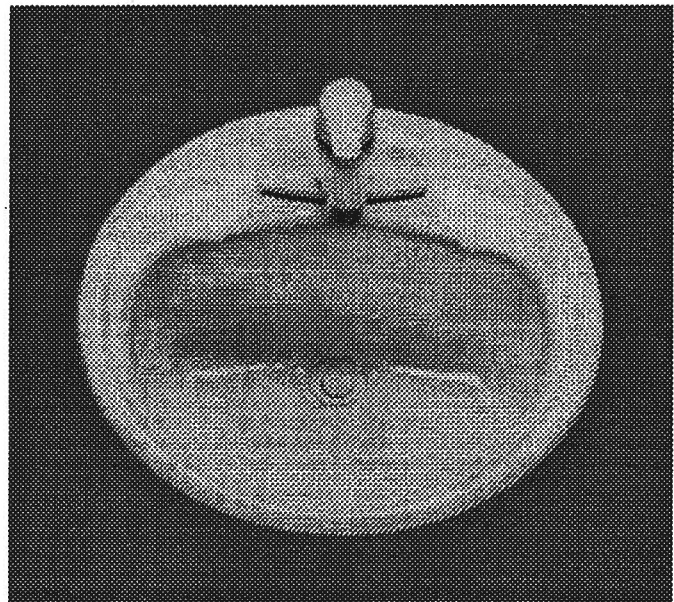

To Be Specified

- Color:
- Faucet*:
- Faucet Finish:
- Supplies:
- 1-1/4" Trap:

* See faucet section for additional models available

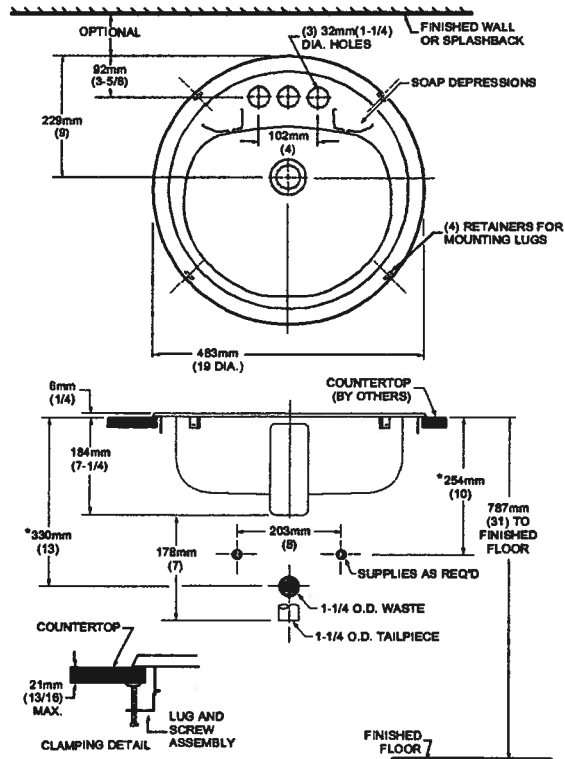

NOTES:

* DIMENSIONS SHOWN FOR LOCATION OF SUPPLIES AND *P* TRAP ARE SUGGESTED. FOR COUNTERTOP CUTOUT AND INSTALLATION INSTRUCTIONS USE TEMPLATE SUPPLIED WITH LAVATORY.

FITTINGS NOT INCLUDED AND MUST BE ORDERED SEPARATELY.

IMPORTANT: Dimensions of fixtures are nominal and may vary within the range of tolerances established by ANSI Standard A112.19.4.

These measurements are subject to change or cancellation. No responsibility is assumed for use of superseded or voided pages.

SPS 3003

LAV-050

Rough Brass Stops
COMPRESSION INLET - COMPRESSION OUTLET
VALVES PACKED 60 OR 125 PER CARTON

| <u>Part Num.</u> | <u>Description</u> | <u>Inlet</u> | <u>Outlet</u> |
|------------------|--------------------|------------------|------------------|
| Angle | | | |
| A211 | CR1B | 3/8" Nom. Compr. | 3/8" O.D. Compr. |
| A213 | CR3B | 3/8" Nom. Compr. | 1/2" O.D. Compr. |
| A212DIM | CR09 / C40 | 1/2" Nom. Compr. | 1/4" O.D. Compr. |
| A212 | CR19 / C60 | 1/2" Nom. Compr. | 3/8" O.D. Compr. |
| A214 | CR39 / C80 | 1/2" Nom. Compr. | 1/2" O.D. Compr. |



| | | | |
|-----------------|------------|------------------------------------|------------------|
| Straight | | | |
| A227 | OCR11/C66S | 3/8" O.D. Compr. (or 1/4" Nom.) | 3/8" O.D. Compr. |
| A225 | OCR3A | 3/8" Nom. Compr. | 1/2" O.D. Compr. |
| A224 | OCR14/C60S | 1/2" Nom. Compr. | 3/8" O.D. Compr. |
| A226 | OCR34/C80S | 1/2" Nom. Compr. | 1/2" O.D. Compr. |



F.I.P. INLET - COMPRESSION OUTLET

| | | | |
|--------------|------------|-------------|-----------------------------|
| Angle | | | |
| A200 | R15 / 63C | 3/8" F.I.P. | 3/8" O.D. Compr. |
| A202 | R35 / 83C | 3/8" F.I.P. | 1/2" O.D. Compr. |
| A201DIM | R07 | 1/2" F.I.P. | 1/4" O.D. Compr. |
| A201 | R17 / 64C | 1/2" F.I.P. | 3/8" O.D. Compr. |
| A203 | R37 / 84C | 1/2" F.I.P. | 1/2" O.D. Compr. |
| A901 | 3301 / 74R | 1/2" F.I.P. | 1/2" & 7/16" O.D. Compr. |

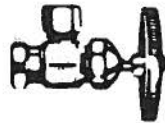

| | | | |
|-----------------|-------------|-------------|------------------|
| Straight | | | |
| A215 | OR10 / 63CS | 3/8" F.I.P. | 3/8" O.D. Compr. |
| A217 | OR30 / 83CS | 3/8" F.I.P. | 1/2" O.D. Compr. |
| A216 | OR12 / 64CS | 1/2" F.I.P. | 3/8" O.D. Compr. |
| A218 | OR32 / 84CS | 1/2" F.I.P. | 1/2" O.D. Compr. |



Fluidyne Ansonia

1 Riverside Drive, Ansonia, CT 06401
 Phone (203) 735-9311; Fax (203) 735-3489



Polybutylene Riser Tubes

Cat. Num. Description Size Length Pack List

Lavatory



| | | | | | |
|--------|--------|-----------|-----|-----|--|
| A400PL | P1-12A | 3/8" O.D. | 12" | 100 | |
| A401PL | P1-15A | 3/8" O.D. | 15" | 100 | |
| A402PL | P1-20A | 3/8" O.D. | 20" | 100 | |
| A403PL | P1-30A | 3/8" O.D. | 30" | 50 | |
| A404PL | P1-36A | 3/8" O.D. | 36" | 50 | |
| A405PL | P3-12A | 1/2" O.D. | 12" | 50 | |
| A406PL | P3-20A | 1/2" O.D. | 20" | 50 | |

| |
|--|
| |
| |
| |
| |
| |
| |
| |
| |

Closet



| | | | | | |
|--------|---------|-----------|-----|-----|--|
| A420PL | P1-12DL | 3/8" O.D. | 12" | 100 | |
| A415PL | P1-15PL | 3/8" O.D. | 15" | 50 | |
| A421PL | P1-20DL | 3/8" O.D. | 20" | 50 | |
| A422PL | P3-12DL | 1/2" O.D. | 12" | 50 | |
| A423PL | P3-20DL | 1/2" O.D. | 20" | 50 | |

| |
|--|
| |
| |
| |
| |
| |
| |
| |
| |

POLY FERRULES

Size Description Pack List

| | | | | |
|--------|-----------|--------------|-----|--|
| A700PL | 1/4" O.D. | Poly Ferrule | 100 | |
| A701PL | 3/8" O.D. | Poly Ferrule | 100 | |
| A703PL | 1/2" O.D. | Poly Ferrule | 100 | |
| A705PL | 5/8" O.D. | Poly Ferrule | 100 | |

| |
|--|
| |
| |
| |
| |
| |
| |
| |
| |

plastic tubular products

"p" traps



| BLACK | WHITE | DESCRIPTION | PAC. PER CARTON | WT. PER CARTON | LIST PRICE EACH |
|-----------|-----------|--|-----------------|----------------|-----------------|
| A01-800 | P01-800 | 1½" x 1½" OR 1½" x 1¼" Solvent Weld | 50 | 14 | |
| A01-800N | P01-800N | 1½" x 1½" OR 1½" x 1¼" Threaded Adapter - boxed | 50 | 14 | |
| A01-800NB | P01-800NB | 1½" x 1½" OR 1½" x 1¼" Threaded Adapter - bagged | 50 | 14 | |
| | | For L.A. Approval Add "LN" After Last Digit Poly Washer included for application to 1½" and 1¼" inlets. | | | |

"s" traps



| | | | | | |
|----------|----------|---|----|----|--|
| A08-800N | P08-800N | 1½" x 1½" OR 1½" x 1¼" Threaded Adapter | 15 | 14 | |
| | | Poly Washer Included for application to 1½" and 1¼" inlets. | | | |

adjustable sink traps



| | | | | | |
|---------|---------|---|----|----|--|
| A13-800 | P13-800 | 1½" x 1½" OR 1½" x 1¼" | 25 | 12 | |
| | | Poly Washer included for application to 1½" and 1¼" inlets. | | | |

quick replacement traps



| | | | | | |
|---------|---------|---|----|----|--|
| A20-800 | P20-800 | 1½" x 1½" OR 1½" x 1¼" | 25 | 12 | |
| | | Poly Washer included for application to 1½" and 1¼" inlets. | | | |

"j" bends



| | | | | | |
|---------|---------|---|----|---|--|
| A27-800 | P27-800 | 1½" x 1½" OR 1½" x 1¼" | 25 | 9 | |
| | | Poly Washer included for application to 1½" and 1¼" inlets. | | | |

r.o. plug



| | | | | | |
|--|---------|-------------------------------|----|----|--|
| | P38-512 | 1½" x 5" | 50 | 14 | |
| | | Rubber stopper and Bead Chain | | | |

A. O. SMITH

Energy Saving Product

FEATURES

CODE COMPLIANCE: H.U.D., B.O.C.A., ASHRAE/IES 90.1b-1992, and 1990 NAECA.

U.L. CERTIFIED to ANSI standards for Household Electric Storage Tank Water Heaters UL 174.

THICK FOAM INSULATION — Minimizes radiant heat loss.

GLASS-LINED TANK — Glass, specifically developed by A. O. Smith ceramic research for water heater use, is fused to steel at 1600°F, providing corrosion protection for years of dependable use. Proven reliable in millions of water heaters for over 50 years.

DIP TUBE — Carries inlet water deep into tank.

ANODE — Heavy duty, tank-mounted, screw-in anode for longer tank life.

THERMOSTAT/HIGH LIMITS — Combination control provides sensitive temperature control and overheat protection. Factory preset at 120°F. Range is 90°F to 150°F. DEN and DEL models are available for 170°F requirements.

ELECTRIC ELEMENTS — Zinc-plated, copper sheath, screw-in type, direct immersion elements mean fast, efficient water heating. Phoenix™ elements available.

ELEMENT SPECIFICATIONS — Two 4500 watt, 240V, single phase elements, non-simultaneous with a recovery of 20.5 gph at 90°F temperature rise supplied as standard equipment on all models - except 20 gallon or less, single element models (see table). DEN and DEL models are available in commercial voltages and temperature ranges.

NON-METALLIC BOILER TYPE DRAIN VALVE (6 and 15 gallon models have a combination 3/4" inlet/drain fitting). A brass drain valve is available as an option on most models.

ENERGY SAVER

ELECTRIC
RESIDENTIAL WATER HEATERS
MODELS EES, EEH, EEST & ELJF

Hwh-1+2



6 YEAR LIMITED TANK WARRANTY

If the tank should leak any time during the first 6 years, under the terms of the warranty, A.O. Smith will furnish a replacement heater. Installation, labor, handling and local delivery are extra. When used commercially, warranty is 1 year. **THIS OUTLINE IS NOT A WARRANTY.** For complete information, consult the written warranty or A. O. Smith Water Products Company.

Warranty does not apply to product installed outside of the United States of America or its territorial possessions and Canada.

ENERGY SAVER

ELECTRIC GLASS-LINED WATER HEATER

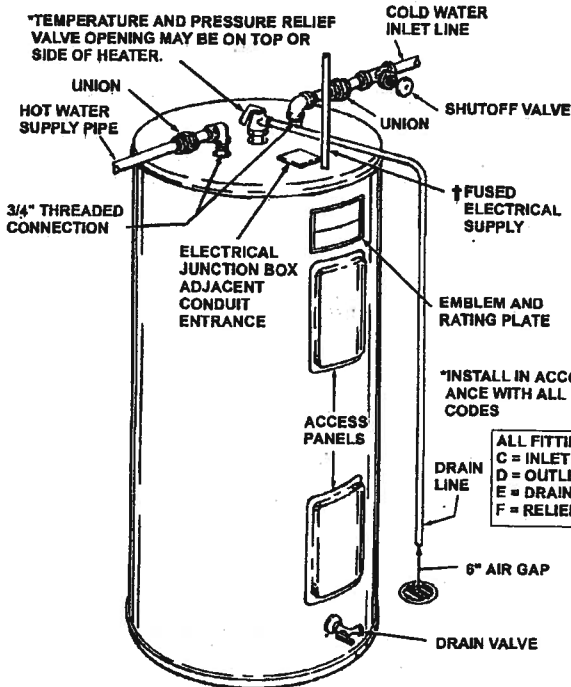

↑ OVERCURRENT PROTECTION MUST BE SUPPLIED IN WATER HEATER CIRCUIT. CONSULT LOCAL CODE OR NEC-1984 FOR PROPER INSTALLATION.

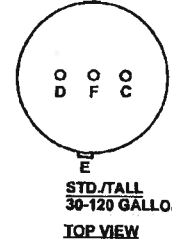
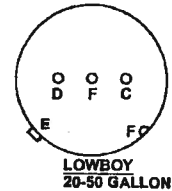
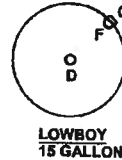
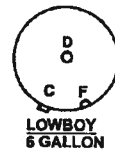

↑ SINGLE DOOR ON LOWBOY MODELS
FRONT VIEW

TYPICAL INSTALLATION

All Dimensions in Inches

| 6-Year Model No. | Gal. Cap. | Element Wattage (Non-Simultaneous) | | A Height | B Dia. | Approx. Ship. Wt. (Lbs.) |
|---|-----------|------------------------------------|---------------------------|----------|--------|--------------------------|
| | | Std. 240 Volts Upper/Lower | Max. 240 Volt Upper/Lower | | | |
| ENERGY SAVER MODELS | | | | | | |
| EES-30 | 30 | 4500/4500 | 4500/4500 | 34 1/2 | 20 1/2 | 94 |
| EES-40 | 40 | 4500/4500 | 6000/6000 | 44 | 20 1/2 | 115 |
| EES-52 | 50 | 4500/4500 | 6000/6000 | 53 3/4 | 20 1/2 | 123 |
| EES-66 | 66 | 4500/4500 | 6000/6000 | 59 3/4 | 21 3/4 | 172 |
| EES-80 | 80 | 4500/4500 | 6000/6000 | 58 1/4 | 24 | 206 |
| EES-120 | 120 | 4500/4500 | 6000/6000 | 61 3/4 | 29 1/2 | 336 |
| ENERGY SAVER TALL MODELS | | | | | | |
| EEST-30 | 30 | 4500/4500 | 6000/6000 | 45 1/4 | 18 | 94 |
| EEST-40 | 40 | 4500/4500 | 6000/6000 | 59 1/4 | 18 | 114 |
| EEST-52 | 55 | 4500/4500 | 6000/6000 | 58 3/4 | 19 1/2 | 132 |
| ENERGY SAVER LOWBOY MODELS | | | | | | |
| ELJF-6 | 6 | --- /1500*D | --- /2500D | 15 1/2 | 14 1/4 | 35 |
| ELJF-15 | 15 | --- /1500*D | --- /2500D | 32 1/2 | 14 1/4 | 58 |
| ELJF-20 | 19.9 | --- /2500* | --- /6000 | 32 1/4 | 18 | 73 |
| ELJF-30 | 30 | 4500/4500 | 6000/6000 | 31 | 21 3/4 | 106 |
| ELJF-40 | 40 | 4500/4500 | 6000/6000 | 32 1/4 | 23 1/4 | 136 |
| ELJF-50 | 50 | 4500/4500 | 6000/6000 | 32 1/4 | 25 1/4 | 171 |
| ENERGY SAVER HIGH ENERGY FACTOR MODELS | | | | | | |
| EEHT-40 | 40 | 4500/4500 | 6000/6000 | 60 | 18 | 120 |
| EEH-52 | 52 | 4500/4500 | 6000/6000 | 54 | 21 3/4 | 131 |
| EEH-66 | 66 | 4500/4500 | 6000/6000 | 60 | 24 | 181 |
| EEH-80 | 80 | 4500/4500 | 6000/6000 | 60 | 25 1/4 | 220 |

*Single element models - Std. 120 volts.

ΔMaximum element wattage is 2500 W 6 & 15 gallon units.

| Element Availability | | | |
|----------------------|------|-------|------|
| 120V | Amps | 240V | Amps |
| 1,500 | 12.5 | 1,500 | 6.3 |
| 2,000 | 16.7 | 2,000 | 8.3 |
| 2,500 | 20.8 | 2,500 | 10.4 |
| 3,000 | 25.0 | 3,000 | 12.5 |
| | | 4,000 | 16.7 |
| | | 4,500 | 18.8 |
| | | 5,000 | 20.8 |
| | | 6,000 | 25.0 |

SUGGESTED SPECIFICATIONS

This water heater(s) shall be A. O. SMITH Model(s) No. _____ electric heater, or an approved equal. Heater(s) shall be rated at _____ KW, _____ volts, single phase, 60 cycle AC and listed by Underwriters' Laboratories. Heater(s) shall have a maximum working pressure of 150 psi, a nominal storage tank capacity of _____ gallons with a separate 3/4" tapping for relief valve installation and a rigidly supported anode rod for maximum cathodic protection. All internal surfaces of the heater(s) exposed to water shall be glass-lined with an alkaline borosilicate composition fused-to-steel. Electric heating element(s) shall be zinc plated copper sheath, screw-in design. Element operation shall be double element, non-simultaneous (or single element). The controls shall include a thermostat with each element and a high temperature cutoff. The jacket shall provide full-size control compartments for performance of service and maintenance through front panel openings and enclose the tank with foam insulation. The drain valve shall be located in the front for ease of servicing (except 6, and 15 gallon have a combination 3/4" inlet/drain fitting). Outer jacket shall be baked enamel finish. Heater(s) shall have a 6 year limited warranty for residential installation; 1 year for commercial installation, as outlined in the written warranty. Fully illustrated instruction manual to be included. Heater(s) shall meet the minimum energy factor required by the Federal "National Appliance Energy Conservation Act of 1987".

A. O. Smith Water Products Co., Inc. On Line
www.hotwater.com

For Technical Information and
Automated Fax Service,
Phone: 800-527-1953

A. O. Smith
Water Products Company
Irving, TX
A Division of A. O. Smith Corporation

A. O. Smith Corporation reserves the right to make product changes or improvements at any time without notice.

WH-1

WATER·TITE PLASTIC HANGER STRAPPING 38

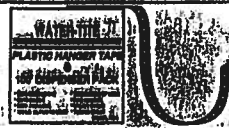
| Product Description | Old Stock Number | New Stock Number | Plastic Gauge | Roll Length | Units/Case | Lbs./Case | Unit Price |
|--|--|------------------|---------------|-------------|------------|-----------|------------|
|  Plastic Hanger Strapping - Flexible, non-conductive, non-abrasive. Can be cut with shears, snips or utility knife. 3/4" wide, .050 thick with 1/8" holes 3/4" apart. 125 lb. | HEAT RATING: 160° Continuous - 180° Intermittent | | | | | | |
| | HS 1 | 83025 | 50 | 100' | 20 | 40 | 11.24 |
| | R HS 10 | 83030 | 50 | 10' | 20 | 10 | 1.46 |
| | R HS 25 | 83035 | 50 | 25' | 20 | 10 | 3.18 |

WAT·TITE J-HOOKS 39

| Product Description | Old Stock Number | New Stock Number | Pipe Size | Shank Length | Units/Case | Lbs./Case | Unit Price |
|---|--|------------------|-----------|--------------|------------|-----------|------------|
|  J-Hooks - ABS plastic construction allows for expansion and contraction, and suspends piping securely. Bagged with nails. | HEAT RATING: 160° Continuous - 180° Intermittent | | | | | | |
| | Baby J-Hook for 1/2" CTS | NEW 93140 | 1/2" | 5" | 400 | 16 | 0.70 |
| | Baby J-Hook for 3/4" CTS | NEW 93142 | 3/4" | 5" | 400 | 16 | 0.76 |
| | Baby J-Hook for 1" CTS | NEW 93144 | 1" | 5" | 400 | 17 | 0.78 |
| | J-Hook for 1 1/2" DWV | NEW 93150 | 1 1/2" | 8" | 200 | 16 | 0.84 |
| | J-Hook for 2" DWV | NEW 93155 | 2" | 8" | 200 | 17 | 0.88 |
| | J-Hook for 3" DWV | NEW 93160 | 3" | 8" | 200 | 20 | 0.96 |
| | J-Hook for 4" DWV | NEW 93165 | 4" | 8" | 100 | 12 | 1.02 |

WATER·TITE PLASTIC WATER HEATER PANS 40

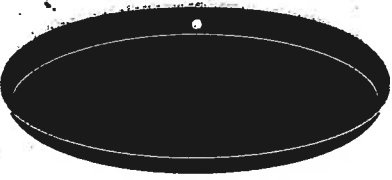
| Product Description | Old Stock Number | New Stock Number | Size ID | Top OD | Units/Case | Lbs./Case | Unit Price |
|--|--|------------------|---------|--------|------------|-----------|------------|
|  Plastic Water Heater Pans - Circular pans recommended for electric water heater protection. Complies with SBCCI Section 1213.7. | 18" Pan Predrilled with 1" Drain Connection | NEW 86970 | 18" | 20" | 20 | 17 | 8.28 |
| | 20" Pan Predrilled with 1" Drain Connection | HP 2022 86975 | 20" | 22" | 20 | 26 | 8.28 |
| | 22" Pan Predrilled with 1" Drain Connection | HP 2224 86980 | 22" | 24" | 20 | 27 | 8.50 |
| | 24" Pan Predrilled with 1" Drain Connection | HP 2426 86985 | 24" | 26" | 20 | 30 | 9.98 |
| | 26" Pan Predrilled with 1" Drain Connection | HP 2628 86990 | 26" | 28" | 10 | 18 | 11.72 |
| | 30" Pan Predrilled with 1" Drain Connection | HP 3032 86995 | 30" | 32" | 5 | 13 | 14.60 |
| | 20" Pan - Undrilled with 1" Drain Connection | HP 2022 NH 86976 | 20" | 22" | 20 | 26 | 8.28 |
| | 22" Pan - Undrilled with 1" Drain Connection | HP 2224 NH 86981 | 22" | 24" | 20 | 27 | 8.50 |
| | 24" Pan - Undrilled with 1" Drain Connection | HP 2426 NH 86986 | 24" | 26" | 20 | 30 | 9.98 |
| | 26" Pan - Undrilled with 1" Drain Connection | HP 2628 NH 86991 | 26" | 28" | 10 | 18 | 11.72 |
| | 30" Pan - Undrilled with 1" Drain Connection | HP 3032 NH 86996 | 30" | 32" | 5 | 13 | 14.60 |
| | 20" Pan Predrilled with 1" CPVC Adapter | HP 2022 C 86979 | 20" | 22" | 20 | 26 | 11.22 |
| | 22" Pan Predrilled with 1" CPVC Adapter | HP 2224 C 86984 | 22" | 24" | 20 | 27 | 11.56 |
| | 24" Pan Predrilled with 1" CPVC Adapter | HP 2426 C 86989 | 24" | 26" | 20 | 30 | 13.36 |
| | 26" Pan Predrilled with 1" CPVC Adapter | HP 2628 C 86994 | 26" | 28" | 10 | 18 | 14.86 |
| | 30" Pan Predrilled with 1" CPVC Adapter | HP 3032 C 86998 | 30" | 32" | 5 | 13 | 17.42 |

WATER·TITE ALUMINUM WATER HEATER PANS 40

| Product Description | Old Stock Number | New Stock Number | Size ID | Top OD | Units/Case | Lbs./Case | Unit Price |
|--|---|------------------|---------|---------|------------|-----------|------------|
|  Aluminum Water Heater Pans - Durable .032 mil. aluminum circular pans recommended for gas water heater protection. Complies with SBCCI Section 1213.7. | 20" Pan Predrilled with 1" Drain Connection | AHP 2022 87000 | 20" | 21 1/2" | 10 | 16 | 19.80 |
| | 22" Pan Predrilled with 1" Drain Connection | AHP 2224 87003 | 22" | 23 1/2" | 10 | 19 | 22.58 |
| | 24" Pan Predrilled with 1" Drain Connection | AHP 2426 87006 | 24" | 25 1/2" | 10 | 23 | 28.84 |
| | 26" Pan Predrilled with 1" Drain Connection | AHP 2628 87010 | 26" | 27 1/2" | 10 | 26 | 44.16 |
| | 30" Pan Predrilled with 1" Drain Connection | AHP 3032 87013 | 30" | 31 1/2" | 5 | 17 | |

WATER·TITE WATER HEATER STAND 41

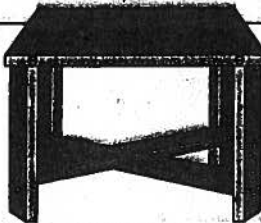
| Product Description | Old Stock Number | New Stock Number | Unit Size | Unit Height | Units/Case | Lbs./Case | Unit Price |
|---|------------------|------------------|-----------|-------------|------------|-----------|------------|
|  Water Heater Stand - Durable galvanized steel stand recommended for 30- 50 gal. capacity gas water heater protection. 650 lb. weight limit (live load tested to 2000 lbs.). | WHS 1 | 83180 | 21" x 21" | 18" | 4 | 55 | 34.40 |

WATER·TITE WASHING MACHINE PANS 42

| Product Description | Old Stock Number | New Stock Number | Size ID | Top OD | Units/Case | Lbs./Case | Unit Price |
|---|--|------------------|-----------|-------------------|------------|-----------|------------|
|  Plastic Washing Machine Pans - | Pan Undrilled with 1" Drain Connection | WMP 1 83200 | 27" x 29" | 27 1/2" x 29 1/2" | 5 | 14 | 26.12 |
| | Pan Undrilled with 1 1/2" Drain Connection | WMP 11 83201 | 27" x 29" | 27 1/2" x 29 1/2" | 5 | 14 | 28.28 |

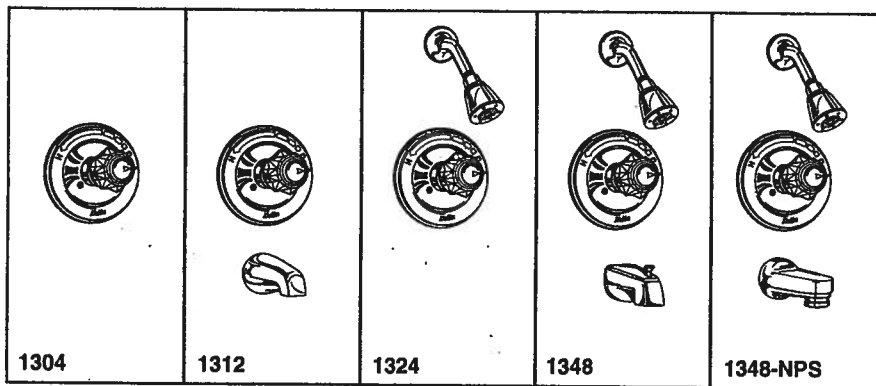

DELTA

BATH MIXING VALVES

- Valve Only (1304 Series)
- Tub Only (1312 Series)
- Shower Only (1324 Series)
- Tub/Shower (1348 Series)
- Single Handle
- Monitor® with Scald-Guard® Valve
- Pressure Balance
- Temperature Only Controlled with Handle

Submitted Model No.: 1348
 Specific Features: _____



UL Listed to US and Canadian Safety Standards 21PL

COMPLIES WITH:

- ASME A112.18.1M-1996
- ASSE 1016-1996
- CSA B125-93
- Indicates ADA compliance to CABO/ANSI A117.1-1992
- Showerhead GSA A-A-240
- ASSE Seal Authorized
- City of L.A. approved
- CSA Certified
- IAPMO Listed

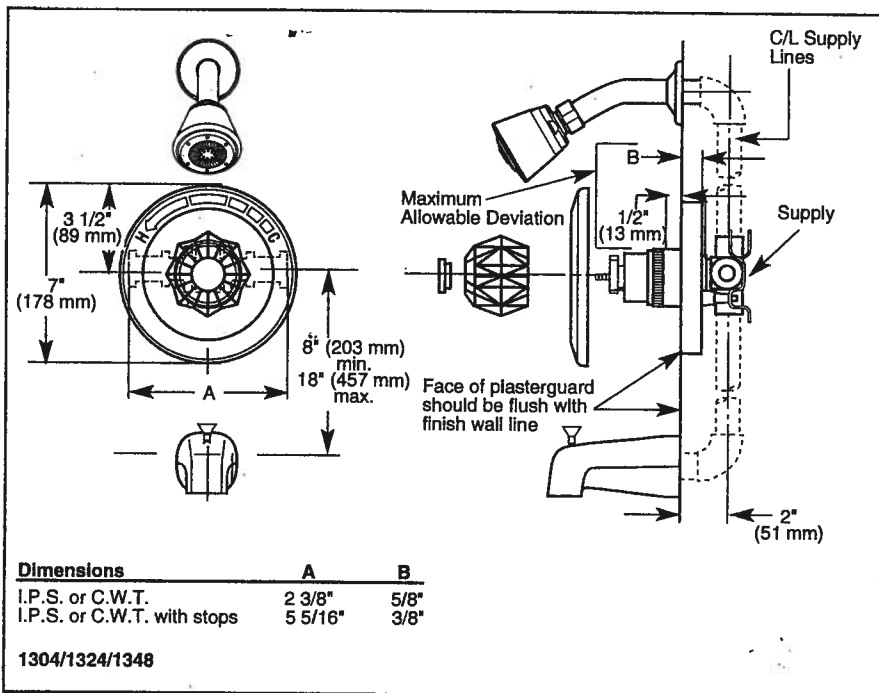

STANDARD SPECIFICATIONS:

- Pressure balanced single handle bath mixing valve.
- Requires 1 1/2" (38 mm) wall cavity.
- Back-to-back installation capability.
- Solid brass fabricated body.
- Clear knob handle with red/blue indicators.
- Monitor® with Scald-Guard® valve. Maintains a balanced pressure of hot and cold water even when a valve is turned on or off elsewhere in the system.
- Temperature only controlled with handle.
- Field adjustable to limit handle rotation into hot water zone.
- 120° maximum handle rotation.
- All parts shall be replaceable from the front of the valve.

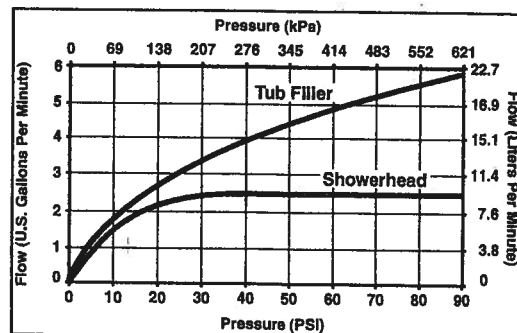

Delta reserves the right (1) to make changes in specifications and materials, and (2) to change or discontinue models, both without notice or obligation. Dimensions are for reference only.

STERLING®

SPECIFICATIONS

BT-1

Advantage™ 5' Tub/Shower
Model OC-AP-TS
60"L x 30"W x 73¼"H
Swirl-gloss surface

The Advantage 5' Tub/Shower is compression-molded from Vikrell™ material. The result is a lightly textured swirl-gloss finish, with color that goes clear through . . . *not* a thin, fragile color coating.

Vikrell is easy to clean, and never needs waxing to maintain its good looks. The swirl-gloss surface helps hide minor scratches, and offers exceptional resistance to permanent damage caused by chips and stress fractures. Lightly "pebbled" slip-resistant bottom enhances user safety and convenience.

4-Piece Design provides installation flexibility. Components move easily around corners and through doorways as narrow as 22". Fixture can be installed easily at any stage of new home construction or remodeling. "Snap together" feature eliminates need for bolts, nuts, wrenches or costly caulking.

Standard Features

- Overall Length 60"
- Overall Width 30"
- Overall Height (Floor to top of fixture) 73¼"
- Depth (Bottom of Tub to Overflow) 12"
- Capacity to Overflow 42 Gallons
- Shipping Weight 116 Lbs.
- 18" grab bar, molded-in toiletry shelves in backwall
- 10-year limited consumer warranty,
- 3-year limited commercial warranty

Standards and Ratings

- Complies with ANSI Z124.1 Standards
- Complies with HUD, UM Bulletin 73A
- Labelled by NAHB Research Foundation, Inc. for compliance
- Flame spread by less than 60 by ASTM E84-87 test method. Class B Rating.

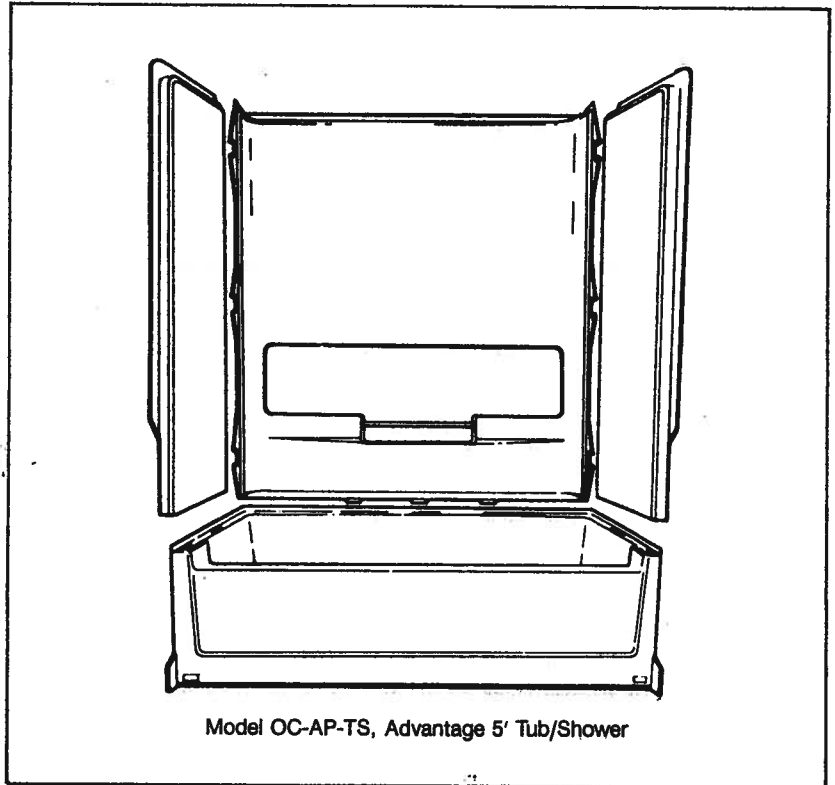

Model OC-AP-TS, Advantage 5' Tub/Shower

Optional Features (Check Options Selected)

- Color** White Bone/Natural

BT-2



Ideas To Make Life Easy.™

S P E C I F I C A T I O N S

Ensemble™
SOLID VIKRELL™ Material
Oval Bath with Tile Wall Surround
 Models 71110110 (Left Drain)
 71110120 (Right Drain)

Standard Specifications

- Complete Unit - Tub/Shower
 - left drainModel 71110110
 - right drainModel 71110120
- Tub Only
 - left drainModel 71111110
 - right drainModel 71111120
- Overall Length60"
- Overall Width43½"
(including 1½" bath nailing flange)
- Overall Height73¾"
(floor to top of nailing flange)
- Overall Bath Height20"
(floor to top of nailing flange)
- Door Opening
 - maximum width58"
 - maximum height55½"
- Bath Depth (floor to top of dam).....16"
- Capacity to Overflow45 Gallons
- Shipping Weight
 - 4 pcs. total176 lbs.
 - bath with integral apron84 lbs.
 - wall set92 lbs.

* Fixture dimensions shown are nominal

Standards and Ratings

- Complies with ANSI Z124.1 and IAPMO Standards and HUD, UM Bulletin 73A
- Certified and labeled by NAHB Research Foundation, Inc. for compliance
- Flame spread less than 45 by ASTM E84 test method.

Optional Features

| Colors | Color Codes** |
|----------------|---------------|
| ■ White | - 0 |
| ■ Bone/Natural | -11 |
| ■ Almond | -47 |
| ■ Ice Grey | -95 |
| ■ Biscuit | -96 |

** Add appropriate color codes to end of model number when ordering.

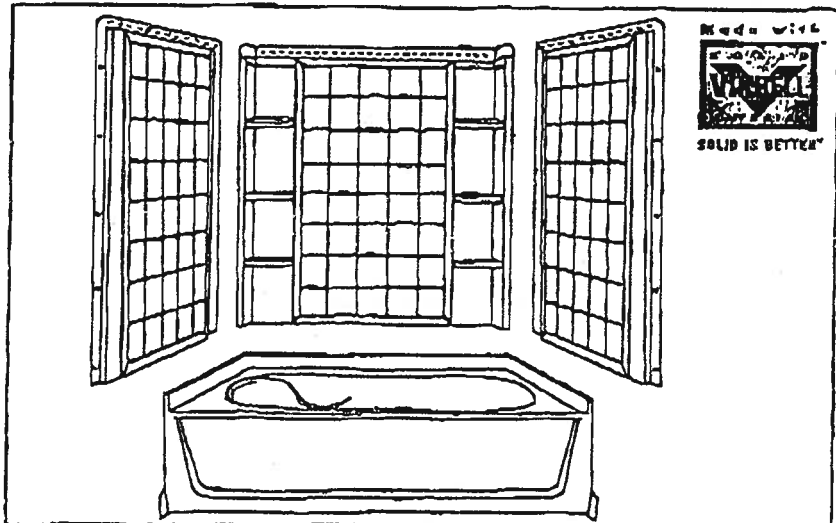

| Features | Benefits |
|---|---|
| Compression molded from Sterling's exclusive Solid VIKRELL™ material | Color molded throughout to eliminate peeling, chipping, and surface cracking for years of trouble free service. |
| Realistic tile wall pattern and finish | Offers the realism of tile without time-consuming cleaning and maintenance. |
| Three piece wall system with generous storage | Provides three convenient shelves along both sides of back wall for toiletries. |
| Modular 4-piece design | Three piece wall system and bath. Components move around corners and through doorways with ease. |
| Bath with integral apron eliminates installation step | Saves installation time and money. |
| Gentle sloping back, neck, and armrest in bath fixture | Makes bathing more comfortable. |
| 3" wainscoat/tile ledge | Extra protection against water damage—wainscoat rises a full 3" above tub ledge—perfect for tile installations in bath only applications. |
| Lightly pebbled bottom surface | Easy to clean and slip resistant for better traction and safer footing. |
| Tongue-in-groove "snap together" design allows for caulkless installation | Installs direct to studwalls without the need for bolts, nuts, adhesives, or caulk. |
| Durable high gloss finish | Maintains a lustrous shine without waxing and offers exceptional resistance to permanent damage. |
| Limited warranty | 10-year consumer/3-year commercial limited warranty to original purchaser. |

American Standard

**COLONY AFTON™
ROUND FRONT TOILET**
VITREOUS CHINA

COLONY AFTON™ ROUND FRONT TOILET

2329.016

- Vitreous china
- Low-consumption (1.6 gpf/6.0 Lpf)
- Round front siphon action bowl with internal jet
- Fully glazed 2" trapway
- American Standard Aquameter™ Water Control
- Water surface area 7-1/4" x 7"
- Color-matched trip lever
- Sanitary bar on bowl
- 2 bolt caps
- 100% factory flush tested

3038.016 Bowl

4392.016 Tank

Nominal Dimensions:

28" x 20" x 29" (711 x 508 x 737mm)

Fixture only, seat and supply by others



To Be Specified

- Color: White
- Seat: American Standard #5322.011 "Rise and Shine" (with easy to clean lift-off hinge system) solid plastic closed front seat with cover. See page TB-001.
- Seat: American Standard #5308.014 "Laurel" molded closed front seat with cover. See page TB-001.
- Alternate Seat:
- Supply with stop:

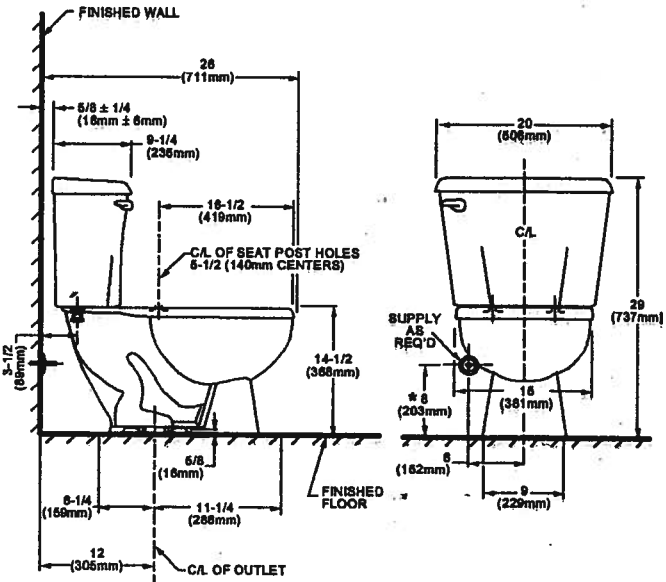

**Compliance Certifications -
Meets or Exceeds the Following Specifications:**
• ASME A112.19.2M (and 19.6M) for Vitreous China Fixtures - includes Flush Performance, Ball Pass Diameter, Trap Seal Depth and all Dimensions

NOTES:
THIS COMBINATION IS DESIGNED TO ROUGH-IN AT A MINIMUM DIMENSION OF 305MM (12") FROM FINISHED WALL TO C/L OF OUTLET.
* DIMENSION SHOWN FOR LOCATION OF SUPPLY IS SUGGESTED.
SUPPLY NOT INCLUDED WITH FIXTURE AND MUST BE ORDERED SEPARATELY.
IMPORTANT: Dimensions of fixtures are nominal and may vary within the range of tolerance established by ANSI Standard A112.19.2
These measurements are subject to change or cancellation. No responsibility is assumed for use of superseded or voided pages.

SPS 2329.016

WC-1

PREMIUM MOLDED WOOD SEATS



Church premium seats add a dramatic new dimension to style and fashion. These seats are engineered with careful attention to every detail. Highest quality, sleek, timeless design from Church.

Seats shall be No. 540 as manufactured by Church Seats. Seats shall be molded wood, multi-coat enamel finish with closed front and cover to fit regular bowl. Color-matched bumpers and hinges. Ultima™ hinges with non-corrosive top-tightening bolts, wing nuts and no-slip washers. Color to be white (specify white or fixture manufacturer's color.)

MODEL 540

- REGULAR SEAT
CLOSED FRONT WITH COVER
- MOLDED WOOD
- ULTIMA™ HINGE

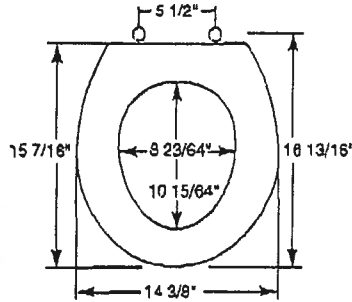

Ring thickness is 3/4"
 Ring thickness including the bumper is 1-1/16"
 Height of the seat with cover is 1-7/8"

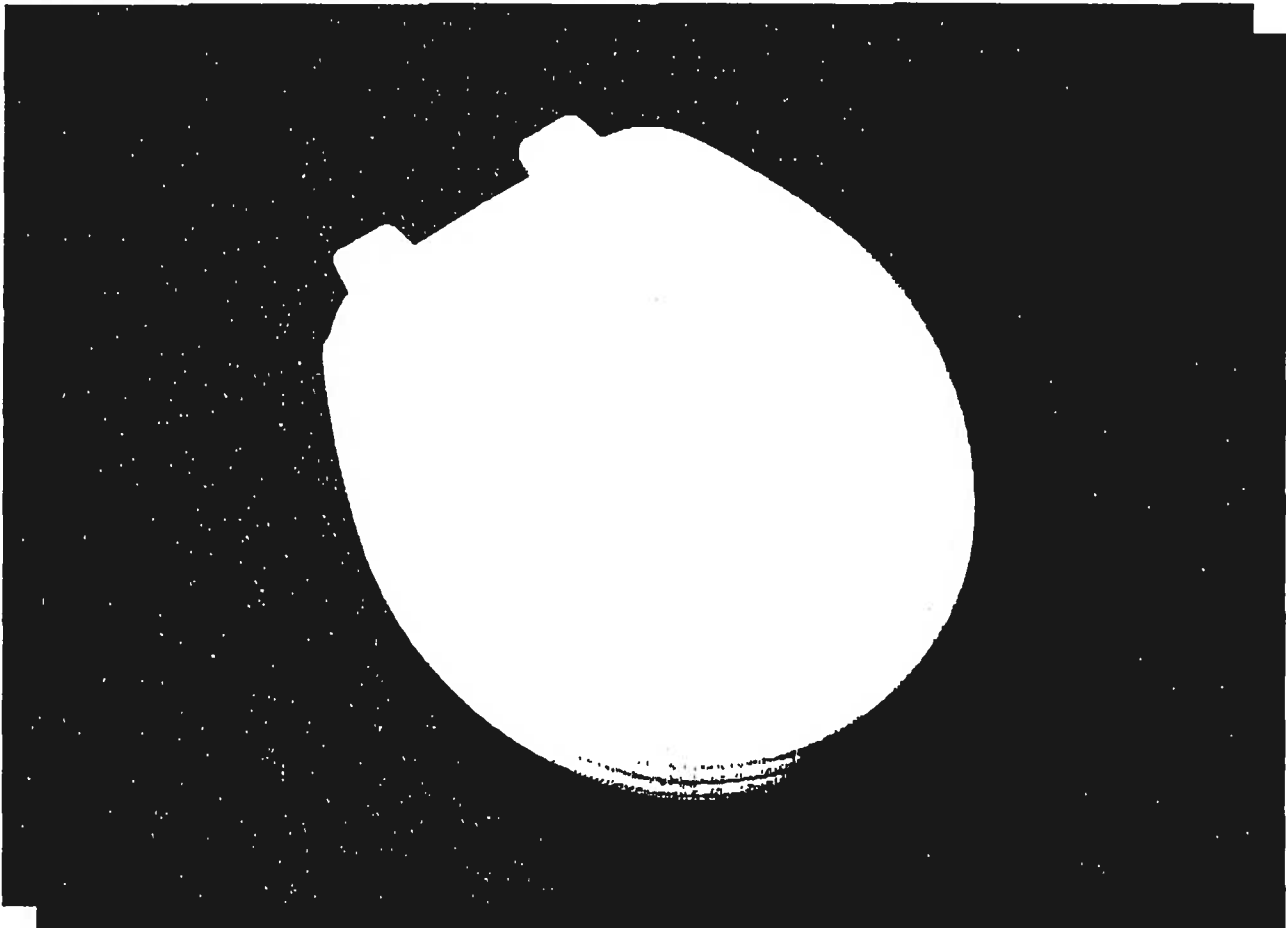

American Standard

H/C Water Closet

CADET™ II 16-1/8" H ELONGATED TOILET

VITREOUS CHINA

 BARRIER FREE

CADET™ II 16-1/8" H ELONGATED TOILET

2216.143 

- Vitreous china
- Low-consumption (6.0 Lpf/1.6 gpf)
- 16-1/8" rim height
- Elongated siphon action bowl
- Fully-glazed trapway
- Close-coupled tank
- American Standard Aquameter water control
- Speed Connect™ tank/bowl coupling system
- Color-matched trip lever
- 2 bolt caps
- 100% factory flush tested

3107.011 Bowl

4072.015 Tank

2216.129 with Slotted Rim for Bedpan holding

3107.129 Bowl

4072.015 Tank

Nominal Dimensions:

768 x 476 x 787mm (30-1/4" x 18-3/4" x 31")

Fixture only, seat and supply by others

Compliance Certifications -

Meets or Exceeds the Following Specifications:

- ASME A112.19.2M (and 19.6M) for Vitreous China Fixtures - includes Flush Performance, Ball Pass Diameter, Trap Seal Depth and all Dimensions

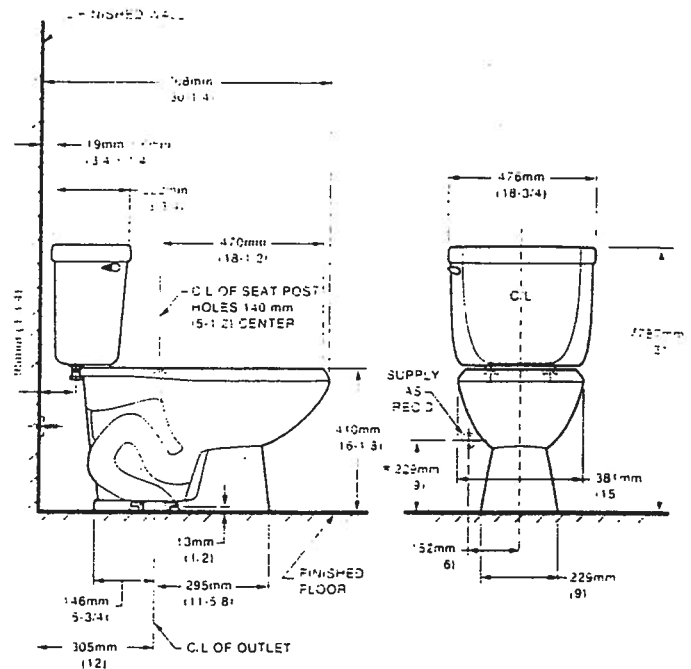
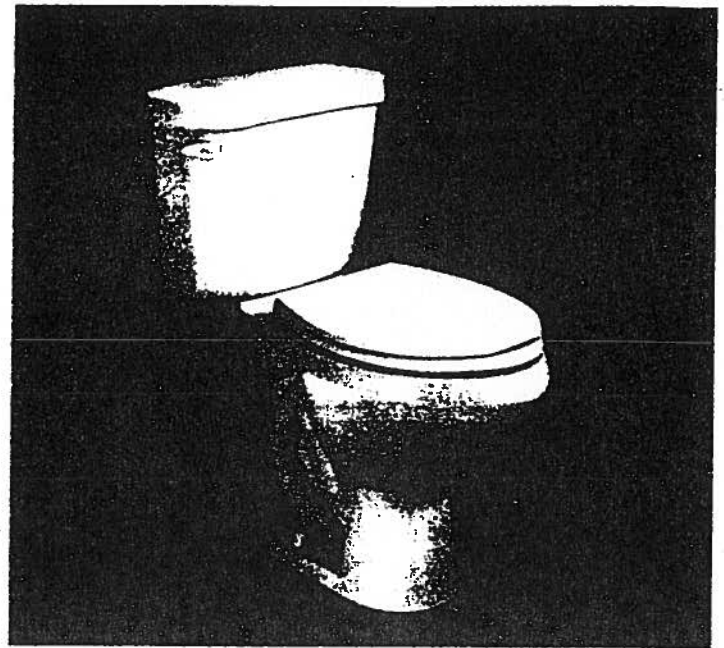

To Be Specified

- Color:
- Seat: American Standard #5324.019 "Rise and Shine" (with easy to clean lift-off hinge system) solid plastic closed front seat with cover. See page TB-001.
- Seat: American Standard #5311.012 "Laurel" molded closed front seat with cover. See page TB-001.
- Alternate Seat:
- Supply with stop:

NOTES:

THIS TOILET IS DESIGNED TO ROUGH-IN AT A MINIMUM DIMENSION OF 305MM (12") FROM FINISHED WALL TO C.L. OF OUTLET
 SUPPLY NOT INCLUDED WITH FIXTURE AND MUST BE ORDERED SEPARATELY
 DIMENSION SHOWN FOR LOCATION OF SUPPLY IS SUGGESTED
 IMPORTANT: Dimensions of fixtures are nominal and may vary within the range of tolerances established by ANSI Standard A112.19.2.
 These measurements are subject to change or cancellation. No responsibility is assumed for use of superseded or voided pages



When installed so top of seat is 432 to 483mm (17" to 19") from the finished floor.
MEETS THE AMERICAN DISABILITIES ACT GUIDELINES AND ANSI A117.1 REQUIREMENTS FOR ACCESSIBLE AND USEABLE BUILDING FACILITIES. CHECK LOCAL CODES.

SPS 2216.143

TB-029/
COM/INS-014

CADET™ II 16-1/8" H EL 1.6 TOILET

VITREOUS CHINA
CLOSE - COUPLED COMBINATION
16-1/8" RIM HEIGHT
SHOWN WITH FLEX SUPPLY

American Standard



2216.129
2216.143



HL Water Closet

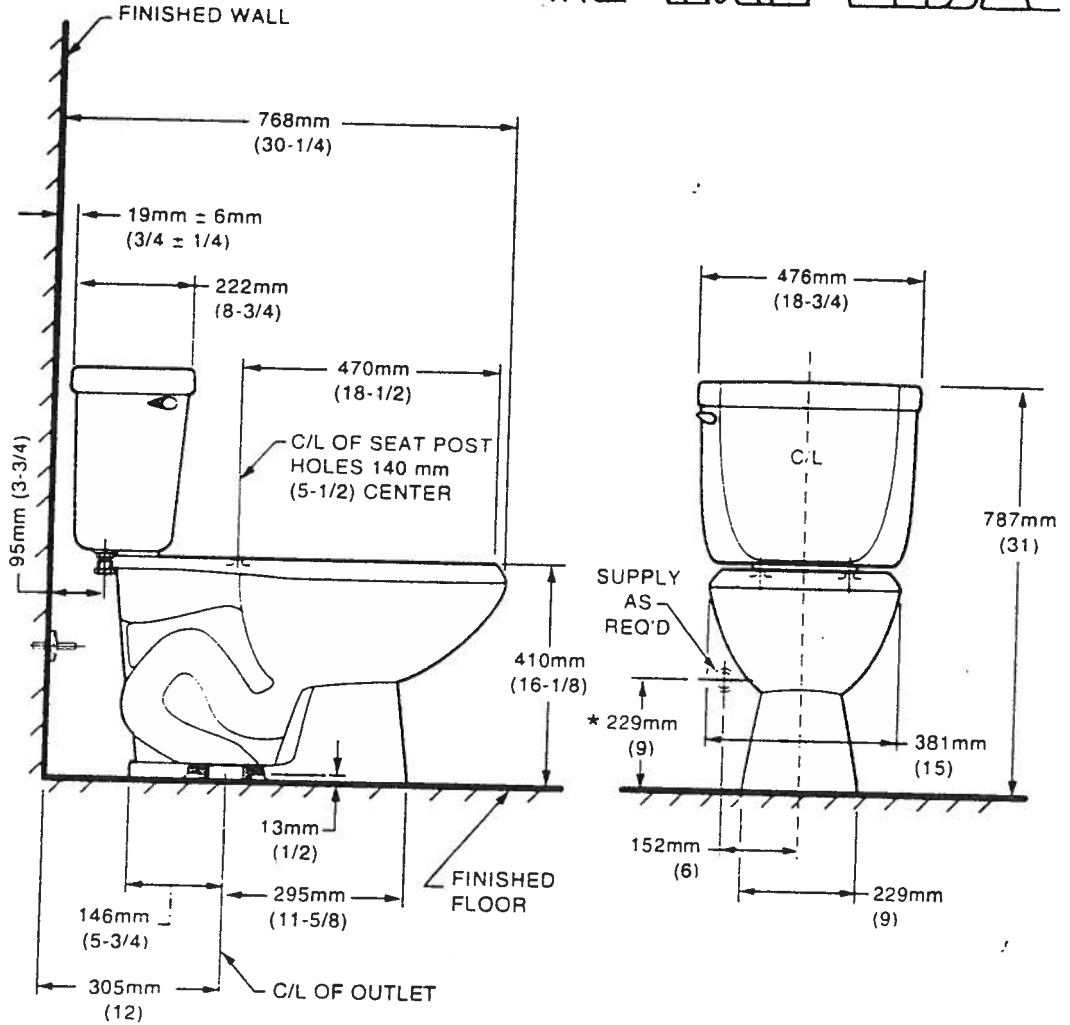

TOILETS

NOTES:

PRODUCT 2216.143 SHOWN, 2216.129 SAME AS EXCEPT WITH SLOTTED RIM FOR BED PAN HOLDING



TOILET DESIGNED TO MEET ADA DISABILITY REQUIREMENTS WHEN TOP OF SEAT IS INSTALLED 432 TO 483MM (17 TO 19) ABOVE THE FINISHED FLOOR.

THIS TOILET IS DESIGNED TO ROUGH - IN AT A MINIMUM DIMENSION OF 305mm (12") FROM FINISHED WALL TO C/L OF OUTLET.

* DIMENSIONS SHOWN FOR LOCATION OF SUPPLY ARE SUGGESTED.

SUPPLY NOT INCLUDED WITH FIXTURE AND MUST BE ORDERED SEPARATELY.

IMPORTANT: Dimensions of fixtures are nominal and may vary within the range of tolerances established by ANSI Standard A112.19.2

These measurements are subject to change or cancellation. No responsibility is assumed for use of superseded or voided leaflet.

COMMERCIAL PLASTIC SEATS



Hlc water Closet

MODEL 295C

Seats shall be No. _____ as manufactured by Church Seats. Seats shall be heavy weight and injection-molded of solid plastic. Seats shall be open front less cover for elongated cowl and feature large molded-in bumpers. External check hinges to feature stainless steel posts that stop seat 11° beyond vertical. Color to be _____ specify white or fixture manufacturer's color. Hinges shall be _____

- ELONGATED SEAT
OPEN FRONT LESS COVER
- SOLID PLASTIC
- EXTERNAL STAINLESS STEEL
CHECK HINGES

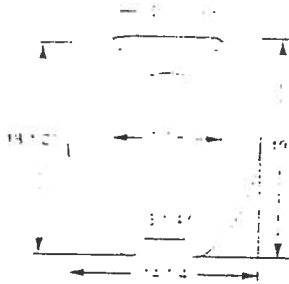
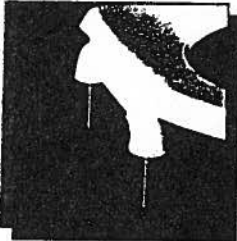
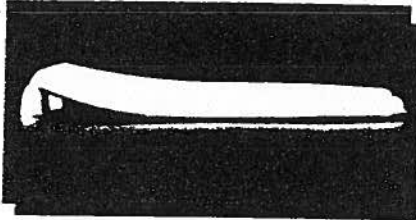

- ┘ 295C Open front seat less cover external check hinge stops seat 11° beyond vertical.
 - ┘ 295SSC Open front seat less cover stainless steel self-sustaining and external check hinge holds seat in any raised position up to 11° beyond vertical.
- Ring thickness is .1216"
 Ring thickness including the bumper is .1216"
 Height of the seat with cover is 2.125"

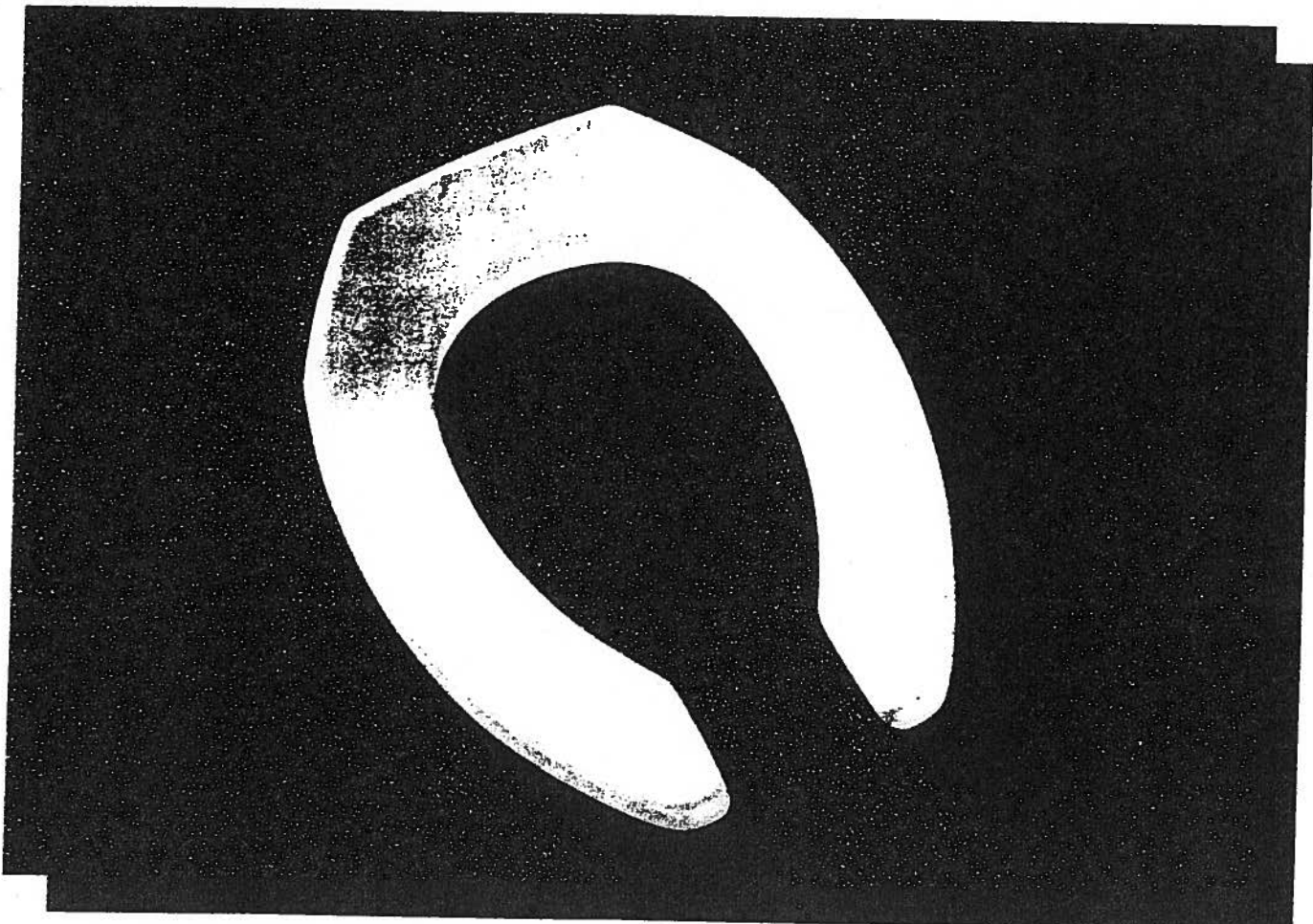

Rough Brass Stops

COMPRESSION INLET - COMPRESSION OUTLET

VALVES PACKED 60 OR 125 PER CARTON

| <u>Part Num.</u> | <u>Description</u> | <u>Inlet</u> | <u>Outlet</u> |
|------------------|--------------------|------------------|------------------|
| Angle | | | |
| A211 | CR1B | 3/8" Nom. Compr. | 3/8" O.D. Compr. |
| A213 | CR3B | 3/8" Nom. Compr. | 1/2" O.D. Compr. |
| A212DIM | CR09 / C40 | 1/2" Nom. Compr. | 1/4" O.D. Compr. |
| A212 | CR19 / C60 | 1/2" Nom. Compr. | 3/8" O.D. Compr. |
| A214 | CR39 / C80 | 1/2" Nom. Compr. | 1/2" O.D. Compr. |

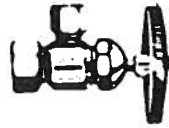

| | | | |
|-----------------|------------|------------------------------------|------------------|
| Straight | | | |
| A227 | OCR11/C66S | 3/8" O.D. Compr. (or 1/4" Nom.) | 3/8" O.D. Compr. |
| A225 | OCR3A | 3/8" Nom. Compr. | 1/2" O.D. Compr. |
| A224 | OCR14/C60S | 1/2" Nom. Compr. | 3/8" O.D. Compr. |
| A226 | OCR34/C80S | 1/2" Nom. Compr. | 1/2" O.D. Compr. |



F.I.P. INLET - COMPRESSION OUTLET

| | | | |
|--------------|------------|-------------|-----------------------------|
| Angle | | | |
| A200 | R15 / 63C | 3/8" F.I.P. | 3/8" O.D. Compr. |
| A202 | R35 / 83C | 3/8" F.I.P. | 1/2" O.D. Compr. |
| A201DIM | R07 | 1/2" F.I.P. | 1/4" O.D. Compr. |
| A201 | R17 / 64C | 1/2" F.I.P. | 3/8" O.D. Compr. |
| A203 | R37 / 84C | 1/2" F.I.P. | 1/2" O.D. Compr. |
| A901 | 3301 / 74R | 1/2" F.I.P. | 1/2" & 7/16" O.D. Compr. |

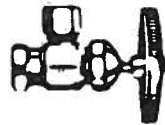

| | | | |
|-----------------|-------------|-------------|------------------|
| Straight | | | |
| A215 | OR10 / 63CS | 3/8" F.I.P. | 3/8" O.D. Compr. |
| A217 | OR30 / 83CS | 3/8" F.I.P. | 1/2" O.D. Compr. |
| A216 | OR12 / 64CS | 1/2" F.I.P. | 3/8" O.D. Compr. |
| A218 | OR32 / 84CS | 1/2" F.I.P. | 1/2" O.D. Compr. |

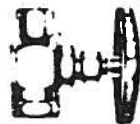

Fluidyne Ansonia

1 Riverside Drive • Ansonia, CT 06401
Phone (203) 735-9311 Fax (203) 735-3489

Polybutylene Riser Tubes



| <u>Cat. Num.</u> | <u>Description</u> | <u>Size</u> | <u>Length</u> | <u>Pack</u> | <u>List</u> |
|------------------|--------------------|-------------|---------------|-------------|-------------|
| Lavatory | | | | | |
| A400PL | P1-12A | 3/8" O.D. | 12" | 100 | \$1.33 |
| A401PL | P1-15A | 3/8" O.D. | 15" | 100 | \$1.59 |
| A402PL | P1-20A | 3/8" O.D. | 20" | 100 | \$1.77 |
| A403PL | P1-30A | 3/8" O.D. | 30" | 50 | \$2.43 |
| A404PL | P1-36A | 3/8" O.D. | 36" | 50 | \$2.87 |
| A405 PL | P3-12A | 1/2" O.D. | 12" | 50 | \$2.54 |
| A406 PL | P3-20A | 1/2" O.D. | 20" | 50 | \$3.65 |

Closet



| | | | | | |
|--------|---------|-----------|-----|-----|--------|
| A420PL | P1-12DL | 3/8" O.D. | 12" | 100 | \$1.33 |
| A415PL | P1-15PL | 3/8" O.D. | 15" | 50 | \$1.59 |
| A421PL | P1-20DL | 3/8" O.D. | 20" | 50 | \$1.77 |
| A422PL | P3-12DL | 1/2" O.D. | 12" | 50 | \$2.54 |
| A423PL | P3-20DL | 1/2" O.D. | 20" | 50 | \$3.65 |

POLY FERRULES

| | <u>Size</u> | <u>Description</u> | <u>Pack</u> | <u>List</u> |
|--------|-------------|--------------------|-------------|-------------|
| A700PL | 1/4" O.D. | Poly Ferrule | 100 | \$0.14 |
| A701PL | 3/8" O.D. | Poly Ferrule | 100 | \$0.14 |
| A703PL | 1/2" O.D. | Poly Ferrule | 100 | \$0.33 |
| A705PL | 5/8" O.D. | Poly Ferrule | 100 | \$0.48 |

CATEGORY 3 WASHING MACHINE AND ICE MAKER OUTLET BOXES

12K™ ICE MAKER BOX WITH NAILS

1MB-1

- Nails preloaded.
- Right or left hand installation.
- Valves comply with requirements of NSF 61, Section 9.
- No support bracket needed.
- Available with copper, CPVC and PEX connections.

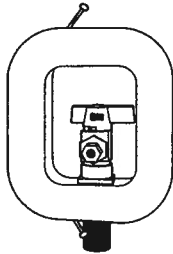

*U.S. Patent Pending



| PROD. NO. | SIZE | DESCRIPTION | U.P.C. CODE | CU. FT. | PACK | CTN. WT. | SHEET PRICE |
|-----------|------|--|---------------|---------|------|----------|-------------|
| 38610 | | 12K with 1/4 Turn MIP valve with 1/2" CPVC tailpiece, installed | 038753-386102 | .40 | 6 | 4.8 | 7.38 |
| 38611 | | 12K with 1/4 Turn valve, installed | 038753-386119 | .40 | 6 | 4.8 | 6.38 |
| 38612 | | 12K with 1/4 Turn valve, installed - CONTRACTOR PACK | 038753-386126 | .80 | 12 | 9.6 | 6.38 |
| 38613 | | 12K with 1/4 Turn MIP valve with FExMA PEX Adapters, installed | 038753-386133 | .40 | 6 | 4.8 | 6.67 |
| 38614 | | 12K with 1/4 Turn MIP valve with 1/2" CPVC Tailpiece, installed - CONTRACTOR PACK | 038753-386140 | .80 | 12 | 9.6 | 7.58 |
| 38615 | | 12K with 1/4 Turn MIP valve with FExMA PEX Adapters, installed - CONTRACTOR PACK | 038753-386157 | .80 | 12 | 9.6 | 6.87 |
| 38609 | | 12K w/ 1/4 Turn MIP valve w/ FExMA Ki-Tech PEX adapters, installed - CONTRACTOR PACK | 038753-386096 | .80 | 12 | 9.6 | 7.87 |
| 38606 | | 12K w/ 1/4 Turn MIP Wirsbo PEX connection, installed - CONTRACTOR PACK | 038753-386065 | .80 | 12 | 9.6 | 7.67 |
| 38616 | | 12K w/ Domestic MIP valve w/ oval handle w/ FExMA adapter - CONTRACTOR PACK | 038753-386164 | .80 | 12 | 9.6 | 6.38 |
| 38617 | | 12K w/ Domestic MIP valve w/ oval handle w/ FExMA adapter | 038753-386171 | .40 | 6 | 4.8 | 7.38 |
| 38618 | | 12K with 1/4 Turn valve without Faceplate | 038753-386188 | .40 | 6 | 4.8 | 5.92 |
| 38619 | | 12K without valve | 038753-386195 | .40 | 6 | 3 | 2.76 |
| 38620 | | 12K Ice Maker Box LESS Cover Plate, without valve | 038753-386201 | .40 | 6 | 3 | 2.67 |

CENTER DRAIN, OFFSET, DOUBLE OUTLET AND ICE MAKER ACCESSORIES

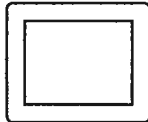

| PROD. NO. | SIZE | DESCRIPTION | U.P.C. CODE | CU. FT. | PACK | CTN. WT. | SHEET PRICE |
|-----------|------|--|---------------|---------|------|----------|-------------|
| 38767 | | WMOB faceplate, electric (ivory) | 038753-387673 | .5 | 6 | 3 | 2.25 |
| 38941 | | WMOB white faceplate - center drain and offset | 038753-389417 | 1 | 12 | 4 | 1.84 |
| 38940 | | WMOB white faceplate - double outlet | 038753-389400 | 1 | 12 | 4 | 1.84 |
| 38942 | | Faceplate white - ice maker | 038753-389424 | 1 | 24 | 6 | 1.46 |
| 38621 | | Faceplate - 12K ice maker | 038753-386218 | .192 | 12 | 1.5 | 1.33 |
| 38768 | | WMOB mounting brackets - center drain and offset | 038753-387680 | .1 | 12 | 1 | .52 |
| 38787 | | WMOB mounting brackets - double outlet | 038753-387871 | .1 | 12 | 1 | .52 |
| 38769 | | Grommets | 038753-387697 | .1 | 12 | 1 | .19 |
| 38829 | 1/2" | Plastic lock nut | 038753-388298 | .1 | 1 | .003 | .17 |
| 38772 | | Conduit lock nut | 038753-387727 | .1 | 12 | 1 | .17 |

REPLACEMENT VALVES - WASHING MACHINE OUTLET BOX



| PROD. NO. | SIZE | DESCRIPTION | U.P.C. CODE | CU. FT. | PACK | CTN. WT. | SHEET PRICE |
|-----------|------|---|---------------|---------|------|----------|-------------|
| 38868 | | CPVC valve WMOB FGG | 038753-388687 | .01 | 1 | 1 | 3.02 |
| 38969 | | 1/4 turn w/ 1/2" CPVC pipe compress blue | 038753-389691 | .01 | 1 | 1 | 5.21 |
| 38870 | | 1/4 Turn red MIP valve w/ long shank | 038753-388700 | .01 | 1 | 1 | 4.71 |
| 38871 | | 1/4 Turn blue MIP valve w/ long shank | 038753-388717 | .01 | 1 | 1 | 4.71 |
| 38977 | | 1/4 Turn red valve w/ PEX adapter | 038753-389776 | .01 | 1 | 1 | 5.11 |
| 38978 | | 1/4 Turn blue valve w/ PEX adapter | 038753-389783 | .01 | 1 | 1 | 5.11 |
| 38999 | | Single lever valve with 1/2" CPVC compression valve | 038753-389991 | .01 | 1 | 1 | 15.62 |
| 38965 | | 1/4 turn w/ 1/2" CPVC pipe compress red | 038753-389653 | .01 | 1 | 1 | 5.21 |
| 38826 | | Single lever valve - CMP | 038753-388267 | .01 | 1 | 2 | 12.89 |
| 38779 | | Long shank adapter 1/2 FExMA | 038753-387796 | .10 | 12 | 1 | 2.63 |
| 38827 | | Long shank MIP valve | 038753-388274 | .01 | 1 | 1 | 2.50 |
| 38788 | | Short stem MIP valve | 038753-387888 | .01 | 1 | 1 | 2.39 |
| 38828 | | Brass compression valve - CMP | 038753-388281 | .01 | 1 | 1 | 2.63 |
| 38880 | | 1/4 Turn MIP Wirsbo PEX - blue | 038753-388809 | .01 | 1 | 1 | 6.11 |
| 38881 | | 1/4 Turn MIP Wirsbo PEX - red | 038753-388816 | .01 | 1 | 1 | 6.11 |
| 38882 | | 1/4 Turn MIP PEX Ki-Tech - red | 038753-388823 | .01 | 1 | 1 | 7.22 |
| 38883 | | 1/4 Turn MIP PEX Ki-Tech - blue | 038753-388830 | .01 | 1 | 1 | 7.22 |

Datey 3

CATEGORY 3 WASHING MACHINE AND ICE MAKER OUTLET BOXES

WM B-1

OFFSET DRAIN WASHING MACHINE OUTLET BOXES

- High impact polystyrene.
- 4 support brackets.
- Easy drain knockout.
- Top mount knockouts.
- Dimensions: Box: 8 3/4" W x 7 1/2" H x 3 5/8" D
Faceplate: 11 3/4" W x 10 1/8" H

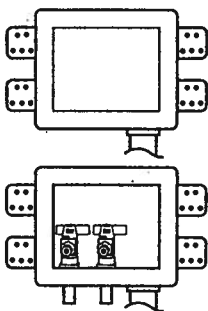

ALLOWS FOR RIGHT HAND DRAIN

| PROD. NO. | SIZE | DESCRIPTION | U.P.C. CODE | CU. FT. | PACK | CTN. WT. | SHEET PRICE |
|-----------|------|--|---------------|---------|------|----------|-------------|
| 38791 | 2" | Plain box in polybag | 038753-387918 | 3.65 | 12 | 17 | 3.21 |
| 38792 | 2" | w/ U.L. Listed 110/250 receptacles w/ long shank single lever valve, installed | 038753-387925 | 3.65 | 12 | 35 | 28.81 |
| 38794 | 2" | w/ long shank MIP valves, installed | 038753-387949 | 3.65 | 12 | 31 | 9.34 |
| 38834 | 2" | w/ MIP valves & screwdriver stop, installed | 038753-388342 | 3.65 | 12 | 36 | 16.64 |
| 38892 | 2" | w/ long shank single lever valve | 038753-388922 | 3.65 | 12 | 35 | 16.05 |
| 38894 | 2" | w/ long shank single lever valve, installed | 038753-388946 | 3.65 | 12 | 33 | 16.98 |
| 38898 | 2" | w/ single lever valve w/ PEX connections, installed | 038753-388984 | 3.65 | 12 | 28 | 19.50 |
| 38899 | 2" | w/ long shank single lever valve - Domestic, installed | 038753-388991 | 3.65 | 12 | 35 | 19.93 |
| 38958 | 2" | TOP MOUNT w/ 1/4 Turn long shank MIP valves w/o faceplate, installed | 038753-389585 | 3.65 | 12 | 31 | 9.13 |
| 38959 | 2" | TOP MOUNT, w/ single lever valve | 038753-389592 | 3.65 | 12 | 35 | 16.98 |
| 38960 | 2" | w/ single lever valve w/ 1/2" CPVC tailpieces, installed | 038753-389608 | 3.65 | 12 | 28 | 20.74 |
| 38961 | 2" | w/ 1/4 Turn compression valves | 038753-389615 | 3.65 | 12 | 291 | 9.47 |
| 38962 | 2" | w/ 1/4 Turn long shank MIP valves, installed | 038753-389622 | 3.65 | 12 | 31 | 9.34 |
| 38964 | 2" | w/ 1/4 Turn long shank MIP valves w/o faceplate, installed | 038753-389646 | 3.65 | 12 | 31 | 9.13 |

CENTER DRAIN WASHING MACHINE OUTLET BOXES

- High impact polystyrene.
- 4 support brackets.
- Easy drain knockout.
- Top mount knockouts.
- Dimensions: Box: 8 3/4" W x 7 1/2" H x 3 5/8" D
Faceplate: 11 3/4" W x 10 1/8" H

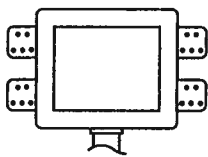

ALLOWS FOR CENTER DRAIN

| PROD. NO. | SIZE | DESCRIPTION | U.P.C. CODE | CU. FT. | PACK | CTN. WT. | SHEET PRICE |
|-----------|-------------|---|---------------|---------|------|----------|-------------|
| 38731 | 2" | Plain box in CONTRACTOR PACK | 038753-387314 | 3.65 | 12 | 19 | 3.31 |
| 38735 | 2" | MIP valves w/ long shank FExMA adapters, installed - CONTRACTOR PACK | 038753-387352 | 3.65 | 12 | 30 | 9.62 |
| 38751 | 2" | Plain box in polybag | 038753-387512 | 3.65 | 12 | 17 | 3.21 |
| 38753 | 2" | Plain box in carton | 038753-387536 | 3.65 | 12 | 19 | 3.67 |
| 38757 | 2" | w/ domestic MIP valves | 038753-387574 | 3.65 | 12 | 28 | 10.40 |
| 38765 | 2" | w/ U.L. Listed 110/250 receptacles w/ domestic MIP valves w/ copper tailpieces, installed | 038753-387659 | 3.65 | 12 | 30 | 28.81 |
| 38782 | 2" | w/ MIP valves | 038753-387826 | 3.65 | 12 | 27 | 9.34 |
| 38816 | 2" | w/ long shank MIP valves, installed | 038753-388168 | 3.65 | 12 | 30 | 9.34 |
| 38819 | 2" | w/ domestic MIP valves & copper tailpieces, installed | 038753-388199 | 3.65 | 12 | 33 | 12.24 |
| 38878 | 2" | w/ MIP valves w/ long shank FExMA adapters, installed | 038753-388786 | 3.65 | 12 | 33 | 10.40 |
| 38927 | 2" | w/ FlowGuard Gold™ ALL-CPVC valves, installed | 038753-389271 | 3.65 | 12 | 28 | 9.25 |
| 38928 | 1 1/2" - 2" | Plain box in polybag | 038753-389288 | 3.65 | 12 | 17 | 3.21 |
| 38930 | 2" | TOP MOUNT w/ 1/4 Turn MIP valves w/ 1/2" CPVC tailpieces, installed | 038753-389301 | 3.65 | 12 | 32 | 10.68 |
| 38931 | 2" | w/ MIP valves, w/ FExMA PEX adapters, installed | 038753-389318 | 3.65 | 12 | 28 | 10.24 |
| 38943 | 2" | w/ 1/4 Turn MIP valves, w/ Wirsbo PEX connection, installed | 038753-389431 | 3.65 | 12 | 33 | 14.95 |
| 38933 | 2" | w/ 1/4 Turn MIP valves w/ 1/2" CPVC tailpieces, installed - CONTRACTOR PACK | 038753-389332 | 3.65 | 12 | 32 | 11.00 |
| 38934 | 2" | w/ 1/4 Turn long shank MIP valves, installed | 038753-389349 | 3.65 | 12 | 30 | 9.61 |
| 38935 | 2" | MIP valves w/ FExMA PEX adapters, installed - CONTRACTOR PACK | 038753-389356 | 3.65 | 12 | 29 | 10.40 |
| 38937 | 2" | w/ 1/4 Turn MIP valves w/ 1/2" CPVC tailpieces, installed | 038753-389370 | 3.65 | 12 | 32 | 10.68 |
| 38938 | 2" | w/ 1/4 Turn compression valves | 038753-389387 | 3.65 | 12 | 29 | 9.47 |
| 38945 | 2" | w/ 1/4 Turn MIP valves w/ FExMA PEX adapters, installed | 038753-389455 | 3.65 | 12 | 33 | 10.24 |
| 38946 | 2" | w/ 1/4 Turn long shank MIP valves, installed - CONTRACTOR PACK | 038753-389462 | 3.65 | 12 | 30 | 9.62 |
| 38799 | 2" | Plain box with grommets | 038753-387994 | 3.79 | 12 | 16 | 3.31 |



Ensemble™
SOLID VIKRELL™ Material
Oval Bath with Tile Wall Surround
 Models 71110110 (Left Drain)
 71110120 (Right Drain)

D I M E N S I O N S

Specification sheets are to be used for reference only, not as a blueprint. Sterling Plumbing, a division of Kohler Co., will not be held responsible for use other than that specified by this disclaimer.

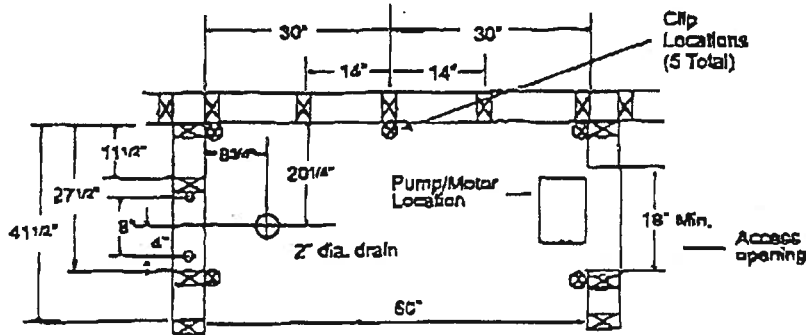

Framing Dimensions

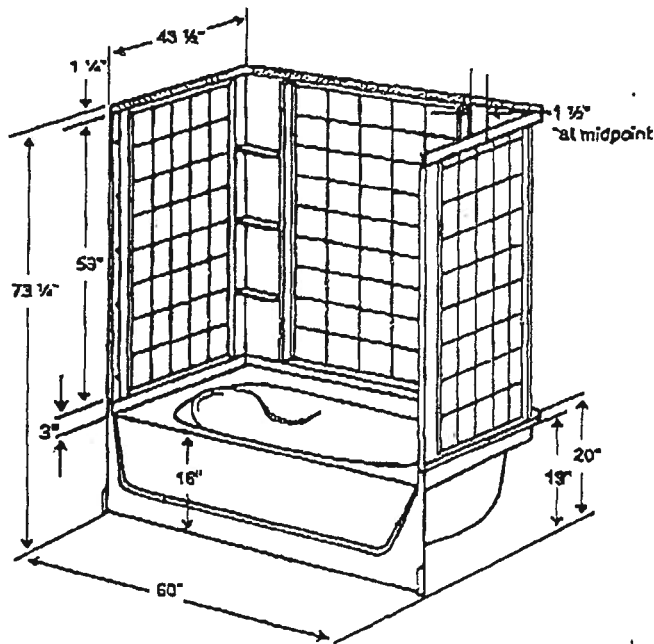

Fixture Dimensions



© 2001 Sterling Plumbing, 444 Highland Drive, Kohler, WI 53044 1-888-STERLING
 www.sterlingplumbing.com

*** made in U.S.A.**

Printed In U.S.A.

Pub. No. 00065 10/01