

Catalog # :

Project :

Prepared By :

Date :



LAD6 6" LED Architectural Downlight

6 inch LED new construction downlight delivers superior performance and energy efficiency. Designed to use anodized aluminum reflectors delivering even illumination and low glare. The high performance luminaire offers 1000 up to 4000 lumens with color temperatures of 2700K, 3000K, 3500K, 4000K at 80 CRI. Standard driver offers universal (120-277V) and 0 -10V dimming down to 1%. The LAD series is ideal for low to medium ceiling heights for retail, hospitality and commercial applications.

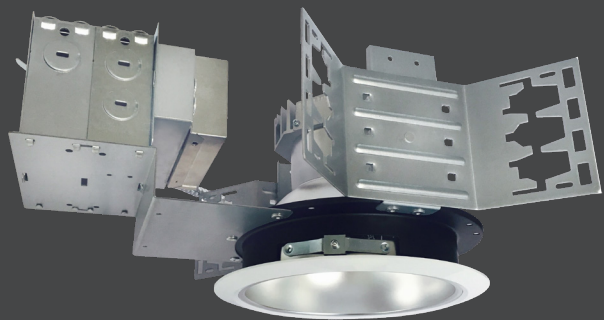

Origin™ Features & Specifications

Optical System

- LED source provides superior lumen output with maximum visual comfort.
- Tailored spot, narrow flood, flood and wide flood beam optics designed for glare free illumination.
- Choice of flanged or flangeless spun reflector utilizing heavy gauge highly reflective diffuse anodized aluminum to deliver low glare, even illumination of the space.
- Reflectors are retained with three retention clips holding the flange tight to the finished ceiling surface.
- Minimum CRI of 80.

Electrical

- High-performance driver features over-voltage, under voltage, short-circuit and over temperature protection.
- 0-10 volt dimming (1% - 100%) standard.
- Standard Universal Voltage (120-277 Vac) Input 50/60 Hz.
- L70 Calculated Life: > 50k Hours projected @ 25°C per IESNA TM-21-11.
- Total harmonic distortion: <20%
- Power factor: >.90
- Input power stays constant over life.
- Compatible with Triac (forward-phase or leading-edge), ELV (reverse-phase or trailing edge) dimming only at 120 Vac.
- Driver can be accessed from below plenum for servicing.
- High-efficacy LEDs with integrated circuit board mount directly to an extruded aluminum heatsink to maximize heat dissipation and promote long life.
- Remote Emergency Battery (120-277V) field installed is available to meet critical life safety lighting requirements. The 90-minute battery provides 7.8watts constant power to the LED system, ensuring code compliance. To calculate light output during emergency mode(EM battery 7.8 watts x LPW of fixture being powered - see spec sheet). Detailed wiring diagram and installation instructions located on website.



Dimensions

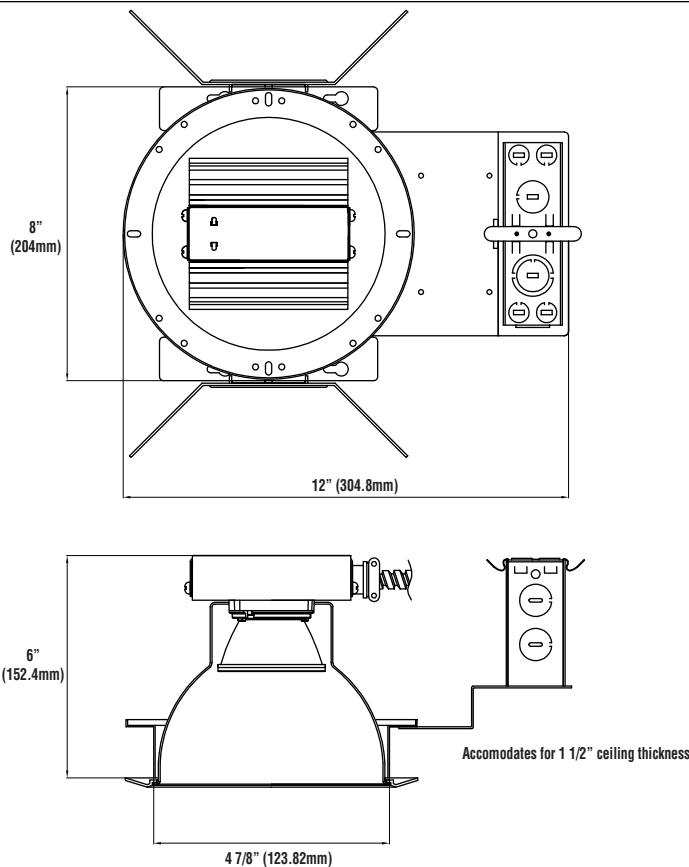



LAD6 6" LED Architectural Downlight

Features & Specifications (cont.)

New Construction Housing/Plaster Frame

- Designed for use in non-insulated ceiling where insulation must be kept a minimum of 3" from the fixture.
- Junction box listed for (8) #12 AWG (four in, four out) 90°C conductors and thru branch wiring.
- Junction box contains (5) 1/2" knockouts with trade pry-out slots and (4) Romex cable clamp knockouts.
- Deep collar accommodates ceiling thickness up to 1-1/2".
- Plaster frame with collar is designed with 20-gauge colled rolled steel, black-painted
- Universal mounting brackets provide up to 5" vertical adjustment and accepts 1/2" EMT conduit.
- Additional channel bar, nailer bar and suspended ceiling accessories available. See accessories.

Installation

- Additional channel bar, nailer bar and suspended ceiling accessories available to accommodate a variety of ceiling types.

Warranty

- LSI LED Fixtures carry a 5-year warranty.
- 1 Year warranty on optional Emergency Battery. Test regularly in accordance with local codes.

Listing

- cETLus Listed to UL 1598 and UL 8750 standards for 25°C Ambient applications
- RoHS Compliant.
- EMI/RFI compliant with FCC 47CFR Part 15 Class B Consumer limits and Class A Commercial & Industrial.
- Damp location rated
- Title 24 Compliant.

Performance

Electrical Data (Amps)*				
Lumen Package	120V	208V	240V	277V
14L	0.12	0.07	0.06	0.05
25L	0.18	0.11	0.09	0.08
32L	0.27	0.15	0.13	0.12
41L	0.35	0.20	0.18	0.15

*Electrical Data at 25C (77F)/ Actual Wattage may differ +/-10%

DELIVERED LUMENS*										
Lumen Pkg.	Distribution	2700K CCT		3000K CCT		3500K CCT		4000K CCT		Wattage
		Delivered Lumens	Efficacy	Delivered Lumens	Efficacy	Delivered Lumens	Efficacy	Delivered Lumens	Efficacy	
14L	SP	1184	84.6	1184	84.6	1467	104.8	1467	104.8	14
	NF	1156	82.6	1156	82.6	1432	102.3	1432	102.3	14
	FL	1152	82.3	1152	82.3	1428	102.0	1428	102.0	14
	WF	1079	77.1	1079	77.1	1337	95.5	1337	95.5	14
25L	SP	2066	93.9	2066	93.9	2560	116.4	2560	116.4	22
	NF	2017	91.7	2017	91.7	2499	113.6	2499	113.6	22
	FL	2011	91.4	2011	91.4	2492	113.3	2492	113.3	22
	WF	1883	85.6	1883	85.6	2333	106.0	2333	106.0	22
32L	SP	2665	83.3	2665	83.3	3302	103.2	3302	103.2	32
	NF	2602	81.3	2602	81.3	3224	100.8	3224	100.8	32
	FL	2594	81.1	2594	81.1	3215	100.5	3215	100.5	32
	WF	2429	75.9	2429	75.9	3010	94.1	3010	94.1	32
41L	SP	3409	81.2	3409	81.2	4224	100.6	4224	100.6	42
	NF	3328	79.2	3328	79.2	4123	98.2	4123	98.2	42
	FL	3318	79.0	3318	79.0	4112	97.9	4112	97.9	42
	WF	3107	74.0	3107	74.0	3849	91.6	3849	91.6	42

*LED Chips are frequently updated therefore values may change.
Data is based on Haze Reflector.



LAD6 6" LED Architectural Downlight

Luminaire Ordering Guide

TYPICAL ORDER EXAMPLE: **LAD6 LED 25L UNV DIM1 35 NF TR6R HAZ**

Family/ Size	LED Gen	Lumen Package	Voltage	Driver	Color Temperature	CRI	Beam Optics ⁶
LAD6 - 6" New Construction ⁴	LED	14L - 1400 25L - 2500 32L - 3200 41L - 4100	UNV - 120-277V	DIM1 - Dims to 1% (0-10V dimming)	30 - 3000K 35 - 3500K 40 - 4000K	Blank - 80 CRI	SP - Spot NF - Narrow Flood FL - Flood WF - Wide Flood

	Reflector	Finish	
Self-Fange	TR6R - Open Reflector	SF HAZ - Haze semi- diffused	
		SF SPC - Specular clear	
	TR6RWW - Wall Wash ²	SF HAZ - Haze semi-diffused	
Flangeless (ship standard w/ white plastic trim ring)	TR6R - Open Reflector	HAZ - Haze semi-diffused, white trim ring	
		SPC - Specular clear, white trim ring	
	TR6RFL - Frosted Floating Lens ³	HAZ - Haze semi-diffused Reflector w/ Frosted Floating Lens, w/ integrated white metal trim ring (optional trim ring not compatible)	
		SPC - Specular Clear Reflector w/ Frosted Floating Lens, w/ integrated white metal trim ring (optional ring not compatible)	
	TR6RWW - Wall Wash ²	HAZ - Haze semi-diffused wall wash reflector, white trim ring	
	TR6B - Baffle	HAZ - Haze semi-diffused reflector	WH - White baffle and white trim ring
			BL - Black Baffle and white trim ring
	TR6BL - Baffle w/ Regressed Lens ¹	HAZ - Hazed semi-diffused	WH - White baffle and white trim ring
			SPC - Specular clear
	TR6RL - Regressed Lens ¹	HAZ - Haze semi-diffused reflector w/ specular clear regressed lens and white trim ring	WH - White baffle and white trim ring
SPC - Specular clear reflector w/ specular clear regressed lens and white trim ring			

Accessory Ordering Information (Accessories are field installed)

Description	Order Number
WH - White metal trim ring (only compatible w/flangeless trims)	616106
EM - Emergency Battery	658633
C27 - 27" channel bars (pair)	205599
C52 - 52" channel bars (pair)	287522
NB - Nailer bar kt (set of 4)	345989
SCIK - Suspended ceiling installation kit (set of 4 channel bars & 4 T-grid clips)	234808

NOTES:

1. Regressed lens trims are wet location listed. All other trims are rated for damp location.
2. TR6RWW wall wash reflector comes with 40° integrated optic; additional beam optics not compatible
3. TR6RFL frosted floating lens comes with integrated white metal trim; accessory white metal trim ring not required)
4. Housing can ship ahead of the light engine and reflector
5. 90 CRI requires 55 day leadtime & 100 MOQ; Consult Factory
6. Refer to IES Files for Beam Spread.



LAD6 6" LED Architectural Downlight

Photometry

LAD6-LED-25L-35-SP-TR6R-SF-HAZ

Lumens: 2,560
Watts: 22.2
Efficacy: 115

Candela Power Distribution

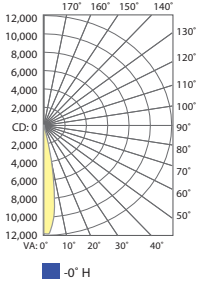

Cone of Light

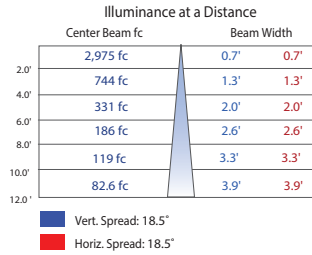

ZONE	LUMENS	% Fixture
0-10	797	31.2%
10-20	766	29.9%
20-30	611	23.9%
30-40	315	12.3%
40-50	51	2.0%
50-60	14	0.5%
60-70	3	0.1%
70-80	1	0.0%
80-90	1	0.0%
90-100	0	0.0%
0-180	2,560	100.0%

Degree Vertical	Candela
0	11,901
5	10,123
10	5,266
15	2,578
20	1,645
25	1,309
30	1,091
35	426
40	128
45	60
50	32
55	14
60	6
65	3
70	1
75	1
80	0
85	1
90	0

LAD6-LED-25L-35-NF-TR6R-SF-HAZ

Lumens: 2,499
Watts: 22.2
Efficacy: 113

Candela Power Distribution

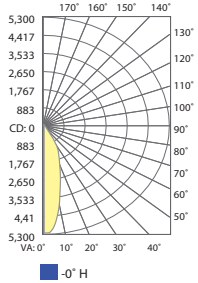

Cone of Light

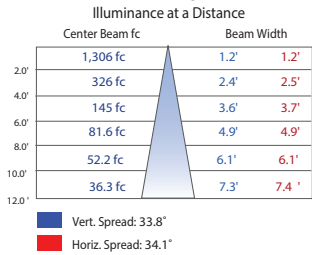

ZONE	LUMENS	% Fixture
0-10	445	17.8%
10-20	831	33.2%
20-30	755	30.2%
30-40	375	15.0%
40-50	71	2.9%
50-60	17	0.7%
60-70	4	0.1%
70-80	1	0.1%
80-90	1	0.0%
90-100	0	0.0%
0-180	2,499	100.0%

Degree Vertical	Candela
0	5,233
5	4,982
10	4,023
15	2,984
20	2,165
25	1,607
30	1,246
35	493
40	180
45	82
50	40
55	16
60	7
65	3
70	2
75	1
80	1
85	0
90	0

LAD6-LED-25L-35-FL-TR6R-SF-HAZ

Lumens: 2,492
Watts: 22.2
Efficacy: 112

Candela Power Distribution

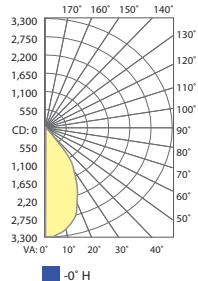

Cone of Light

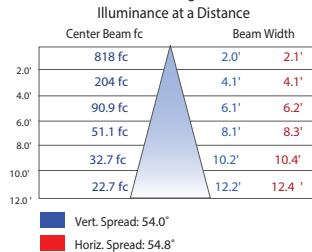

ZONE	LUMENS	% Fixture
0-10	304	12.2%
10-20	773	31.0%
20-30	8475	34.0%
30-40	443	17.8%
40-50	99	4.0%
50-60	19	0.8%
60-70	4	0.2%
70-80	2	0.1%
80-90	1	0.0%
90-100	0	0.0%
0-180	2,492	100.0%

Degree Vertical	Candela
0	3,271
5	3,236
10	3,071
15	2,780
20	2,315
25	1,812
30	1,415
35	624
40	257
45	120
50	52
55	18
60	7
65	4
70	2
75	1
80	1
85	0
90	0



LAD6 6" LED Architectural Downlight

Photometry (cont.)

LAD6-LED-25L-35-WF-TR6R-SF-HAZ

Lumens: 2,333
Watts: 22.2
Efficacy: 105

Candela Power Distribution

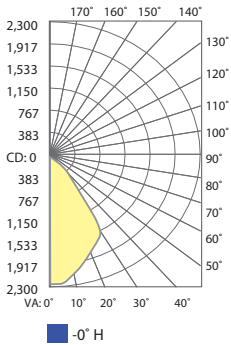

Cone of Light

Illuminance at a Distance

Center Beam fc	Beam Width	
2.0'	515 fc	2.6' 2.6'
4.0'	138 fc	5.3' 5.3'
6.0'	61.2 fc	7.9' 7.9'
8.0'	34.4 fc	10.5' 10.5'
10.0'	22.0 fc	13.1' 13.1'
12.0'	15.3 fc	15.8' 15.8'

Vert. Spread: 66.6°
Horiz. Spread: 66.6°

ZONE	LUMENS	% Fixture
0-10	203	8.7%
10-20	532	22.8%
20-30	754	32.3%
30-40	558	23.9%
40-50	218	9.4%
50-60	53	2.3%
60-70	10	0.4%
70-80	4	0.2%
80-90	1	0.0%
90-100	0	0.0%
0-180	2,333	100.0%

Degree Vertical	Candela
0	2,204
5	2,176
10	2,044
15	1,885
20	1,752
25	1,642
30	1,502
35	820
40	473
45	277
50	135
55	48
60	18
65	9
70	5
75	3
80	2
85	1
90	0

6" Recessed Downlight Reflectors



TR6R - Open Reflector
Self-Flange or Flangeless
HAZ - Haze semi-diffused
SPC - Specular clear



TR6RFL - Frosted floating lens
Flangeless
HAZ - Haze semi-diffused
SPC - Specular clear
Integrated white metal trim ring



TR6BL - Baffle w/ regressed lens
Flangeless
HAZ - Haze semi-diffused
SPC - Specular clear
Choice of white or black baffle
Wet Location listed



TR6RWW - Wall wash w/ Kick reflector
Self-Flange or Flangeless
HAZ - Haze semi-diffused



TR6B - Baffle
Flangeless
HAZ - Haze semi-diffused reflector
Choice of white or black baffle



TR6RL - Regressed lens w/specular clear reflector
Flangeless
HAZ - Haze semi-diffused
SPC - Specular clear
Wet Location Listed