

**Table 7.51: D-Frame (600 A 600 Vac) 3P 50/60 Hz Circuit Breaker with Lugs and Electronic Trip Units♦**

Electronic Trip Unit Type	Trip Function	Trip Unit	Continuous Current▲	G Interrupting		J Interrupting		L Interrupting		Terminal Wire Range (AWG/kcmil)
				Cat. No.	\$ Price	Cat. No.	\$ Price	Cat. No.	\$ Price	
Standard	LS	STR23SP	150 A	DGL36150E20	5081.00	DJL36150E20	8478.00	DLL36150E20	9918.00	(1) 2–600 Cu or (1) 2–500 Al
			250 A	DGL36250E20	5081.00	DJL36250E20	8478.00	DLL36250E20	9918.00	
			400 A	DGL36400E20	5081.00	DJL36400E20	8478.00	DLL36400E20	9918.00	
			600 A	DGL36600E20	8315.00	DJL36600E20	8865.00	DLL36600E20	13586.00	
	LSI	SR53UP-F■	150 A	DGL36150E53	6200.00	DJL36150E53	9597.00	DLL36150E53	11037.00	(1) 2–600 Cu or (1) 2–500 Al
			250 A	DGL36250E53	6200.00	DJL36250E53	9597.00	DLL36250E53	11037.00	
			400 A	DGL36400E53	6200.00	DJL36400E53	9597.00	DLL36400E53	11037.00	
			600 A	DGL36600E53	9429.00	DJL36600E53	9984.00	DLL36600E53	14705.00	
	LSIG	STR53UP-FT■	150 A	DGL36150E54	7527.00	DJL36150E54	10925.00	DLL36150E54	12365.00	(1) 2–600 Cu or (1) 2–500 Al
			250 A	DGL36250E54	7527.00	DJL36250E54	10925.00	DLL36250E54	12365.00	
			400 A	DGL36400E54	7527.00	DJL36400E54	10925.00	DLL36400E54	12365.00	
			600 A	DGL36600E54	10761.00	DJL36600E54	11312.00	DLL36600E54	16032.00	
Ammeter	LSI	STR53UP-FI■	150 A	DGL36150E58	7661.00	DJL36150E58	11058.00	DLL36150E58	12498.00	(1) 2–600 Cu or (1) 2–500 Al
			250 A	DGL36250E58	7661.00	DJL36250E58	11058.00	DLL36250E58	12498.00	
			400 A	DGL36400E58	7661.00	DJL36400E58	11058.00	DLL36400E58	12498.00	
			600 A	DGL36600E58	10895.00	DJL36600E58	11445.00	DLL36600E58	16166.00	
	LSIG	STR53UP-FTI■	150 A	DGL36150E59	8990.00	DJL36150E59	12387.00	DLL36150E59	13827.00	(1) 2–600 Cu or (1) 2–500 Al
			250 A	DGL36250E59	8990.00	DJL36250E59	12387.00	DLL36250E59	13827.00	
			400 A	DGL36400E59	8990.00	DJL36400E59	12387.00	DLL36400E59	13827.00	
			600 A	DGL36600E59	9434.00	DJL36600E59	12774.00	DLL36600E59	17495.00	

▲ D-frame circuit breakers 400 A and below are 100% rated. 600 A is standard (80%) rated only.  
■ F = Fault indicator; T = Residual-type ground-fault protection; I = Ammeter  
♦ Available with lugs (L) or bus (F) connections only.

**Table 7.52: D-Frame 3P 600 A Circuit Breaker, Frame Only, and Field-Installable Trip Units**

Basic Frame Only (600 Vac)*							Field Installable D-Frame Electronic Trip Unit				
Ampere Rating	G Interrupting		J Interrupting		L Interrupting		Long-time, Short-time and Instantaneous Protection				
	Cat. No.	\$ Price	Cat. No.	\$ Price	Cat. No.	\$ Price	Description	Factory Code	Trip Function	Cat. No.	\$ Price
150 A	DGL36150F40	2766.00	DJL36150F40	6164.00	DLL36150F40	7602.00	STR23SP	E20	LS	36940	2033.00
250 A	DGL36250F40	2766.00	DJL36250F40	6164.00	DLL36250F40	7602.00	STR53UP-F	E53	LSI	36942	3152.00
400 A	DGL36400F40	2766.00	DJL36400F40	6164.00	DLL36400F40	7602.00	STR53UP-FT	E54	LSIG	36943	4479.00
600 A	DGL36600F60	5904.00	DJL36600F60	6456.00	DLL36600F60	11177.00	STR53UP-FI	E58	LSI	36944	4613.00
							STR53UP-FTI	E59	LSIG	36945	5942.00

\* Available with lugs (L) or bus (F) connections only.

**Table 7.53: M-Frame 800 A, Basic Electronic Trip System Type ET 1.0▼ Factory-Sealed Trip Unit**

Electronic Trip Unit Type	Trip Function	Sensor Rating	G Interrupting		J Interrupting		Terminal Wire Range (AWG/kcmil)
			Cat. No.	\$ Price	Cat. No.	\$ Price	
<b>2P, 600 Vac 50/60 Hz</b>							
Basic	Fixed Long-time, Adjustable Instantaneous Trip	300 A	MGL26300	5960.00	MJL26300	7829.00	(3) 3/0–500 Al/Cu
		350 A	MGL26350	5960.00	MJL26350	7829.00	
		400 A	MGL26400	5960.00	MJL26400	7829.00	
		450 A	MGL26450	5960.00	MJL26450	7829.00	
		500 A	MGL26500	5960.00	MJL26500	7829.00	
		600 A	MGL26600	5960.00	MJL26600	7829.00	
		700 A	MGL26700	7719.00	MJL26700	9657.00	
		800 A	MGL26800	7719.00	MJL26800	9657.00	
<b>3P, 600 Vac 50/60 Hz</b>							
Basic	Fixed Long-time, Adjustable Instantaneous Trip	300 A	MGL36300	7560.00	MJL36300	9456.00	(3) 3/0–500 Al/Cu
		350 A	MGL36350	7560.00	MJL36350	9456.00	
		400 A	MGL36400	7560.00	MJL36400	9456.00	
		450 A	MGL36450	7560.00	MJL36450	9456.00	
		500 A	MGL36500	7560.00	MJL36500	9456.00	
		600 A	MGL36600	7560.00	MJL36600	9456.00	
		700 A	MGL36700	9927.00	MJL36700	11882.00	
		800 A	MGL36800	9927.00	MJL36800	11882.00	

▼ The ET 1.0 trip unit cannot be field replaced or have the long-time trip point setting adjusted. It is considered an electronic equivalent of a thermal-magnetic circuit breaker.

**Table 7.54: Termination Options**

Frame	Termination Letter	Termination Option
D-Frame	F	No Lugs (Includes terminal nut kit on both ends)
	L	Lugs both ends
	M	Lugs ON end Terminal Nut Kit Off end
	P	Lugs OFF end Terminal Nut Kit On end
	N Δ	Plug-in
	D Δ	Drawout
	S Δ	Rear Connected
M-Frame	F	No Lugs
	L	Lugs both ends
	M	Lugs ON end Terminal Nut Kit Off end
	P	Lugs OFF end Terminal Nut Kit On end

For factory-installed termination, place termination letter in the third block of the circuit breaker catalog number.

**M<sub>1</sub>G<sub>1</sub>L<sub>1</sub>36400□ or D<sub>1</sub>G<sub>1</sub>L<sub>1</sub>36400□E<sub>2</sub>□**  
□ Termination Letter

Δ For N, D, and S pricing, add termination pricing to price. See page 7-42.

**Table 7.55: D- and M-Frame Interrupting Ratings**

Voltage	Interrupting Rating		
	G	J	L□
240 Vac	65 kA	100 kA	150 kA
480 Vac	35 kA	65 kA	100 kA
600 Vac	18 kA	25 kA	25 kA





□ L interrupting rating is not available in M-frame.



D-Frame Circuit Breaker



M-Frame Circuit Breaker

	600 A L-Frame			PowerPact 800 A M-Frame		PowerPact 1200 A P-Frame				1000 A M-Frame				
														
Circuit Breaker Type	LX	LXI	LE	<b>MG</b>	MJ	PG	PJ	PK	PL	MA	MH	MX	ME	
Number of Poles	3	3	3	2, 3	2, 3	2, 3, 4	2, 3, 4	2, 3, 4	2, 3, 4	2, 3	2, 3	3	3	
Current Range	100–600	100–600	100–600	300– <b>800</b>	300–800	100–1200	100–1200	100–1200	100–1200	300–1200	300–1200	450–800	450–800	
Interrupting Ratings														
UL/CSA/NOM Rating (kA RMS) (50/60 Hz)	240 Vac	100	200	100	65	100	65	100	65	125	42	65	65	65
	480Y/277 Vac	65	200	65	35	65	35	65	50	100	30	65	65	65
	480 Vac	65	200	65	35	65	35	65	50	100	30	65	65	65
	600Y/347 Vac	35	100	35	18	25	18	25	50	25	22	25	25	25
DC Ratings	240 Vac	35	100	35	18	25	18	25	50	25	22	25	25	25
	250 Vdc	—	—	—	—	—	—	—	—	—	14	50	—	—
IEC (kA RMS) Icu/Ics	500 Vdc▲	—	—	—	—	—	—	—	—	—	—	20	—	—
	240 Vac	—	—	—	50/25	65/35	50/25	65/35	50/25	125/65	—	—	—	—
IEC 50/60 Hz	415 Vac	65/65△	—	65/65△	35/20	50/25	35/20	50/25	50/25	85/45	30/30	65/33	65/33	65/33
	For additional IEC ratings, see the Supplemental Digest.										For additional IEC ratings, see the Supplemental Digest.			
Special Ratings														
Fed. Specs W-C-375B/GEN	X	X	X	X	X	X	X	X	X	X	X	X	X	X
HACR (2P, 3P)	—	—	—	X	X	X	X	X	X	X	X	X	—	—
Connections/Terminations														
Unit Mount	X	X	X	X	X	X	X	X	X	X	X	X	X	X
I-Line®	X	X	X	X	X	X	X	X	X	X	X	X	X	X
Rear Connection	—	—	—	—	—	—	—	—	—	—	X	X	—	—
Drawout	—	—	—	—	—	X▼	X▼	X▼	X▼	—	—	—	—	—
Optional Lugs	X	X	X	X	X	X	X	X	X	X	X	X	X	X
Accessories and Modifications														
Shunt Trip	X	X	X	X	X	X	X	X	X	X	X	X	X▼	X▼
Undervoltage Trip	X	X	X	X	X	X	X	X	X	X	X	X	X▼	X▼
Auxiliary Switches	X	X	X	X	X	X	X	X	X	X	X	X	X▼	X▼
Alarm Switch	X	X	X	X	X	X	X	X	X	X	X	X	X▼	X▼
Motor Operator	—	—	—	—	—	X▼	X▼	X▼	X▼	X	X	—	—	—
Handle Operators	—	—	—	—	—	X▼	X▼	X▼	X▼	X	X	X	X	X
Mechanical Interlocks (3P)	—	—	—	—	—	X	X	X	X	X★	X★	—	—	—
Handle Padlock Attachment	X	X	X	X	X	X	X	X	X	X	X	X	X	X
Cylinder Lock (3P)	—	—	—	X	X	—	—	—	—	X	X	—	—	—
Optional GF Protection	X▼	X▼	X▼	—	—	X	X	X	X	—	—	X▼	X▼	—
Trip System Type														
Thermal-magnetic	—	—	—	—	—	—	—	—	—	X	X	—	—	—
Instantaneous-only (MCP)	—	—	—	—	—	—	X	X	—	X	X	—	—	—
Molded Case Switch (Automatic)	—	—	—	—	—	X	X	X	X	—	X	—	—	—
Electronic	X	X	X	X	X	X	X	X	X	—	—	X	X	X
Enclosures (Pages 7-56–7-58)														
General Purpose (NEMA 1)	—	—	—	X	X	X	X	X	X	X	X	X	X	X
Raintight (NEMA 3R)	—	—	—	X	X	X	X	X	X	X	X	X	X	X
Dust-tight (NEMA 12)	X	X	X	X	X	X	X	X	X	X	X	X	X	X
Watertight (NEMA 4, 4X, 5)	—	—	—	X	X	—	—	—	—	X	X	X	X	X
Explosion Proof (NEMA 7, 9)	—	—	—	—	—	—	—	—	—	—	—	—	—	—
Dimensions (3P Unit Mount)	Height—in. (mm)	11.86 (301)			12.80 (325)		16.20 (413)				14 (356)			
	Width—in. (mm)	7.5 (190)			8.30 (210)		8.30 (210)				9 (229)			
	Depth—in. (mm)	6.74 (171)			8.10 (205)		8.10 (205)				6.5 (165)			
Pages (Unit Mount)/(I-Line)	Page 7-52/9-28			Page 7-25/9-28		Page 7-26, 7-30, 7-33/9-29				Supplemental Digest Section 3				

Note: All circuit breakers on this chart are UL Listed and CSA Certified unless otherwise noted.

- ▲ Ungrounded UPS systems only. See page 7-34.
- ◆ UL PowerPact MG/MJ and PG/PJ/PK/PL are 60 Hz only.
- ◆ Dual UL and IEC ratings and CE markings on circuit breakers. For additional IEC ratings, see the Supplemental Digest.
- ★ Requires breaker with WB suffix
- ▼ Factory-installed option only.
- △ 65/50 kA Icu/Ics for 450–800 A ratings.

**Table 7.14: Accessories for Use with QO® and QOB Miniature Circuit Breakers**

	Description	Cat. No.	\$ Price	Schedule
<b>Handle Attachments</b>				
Handle Tie:	Converts any two adjacent 120/240 Vac 1P QO circuit breakers to independent trip 2P	QO1HT	3.80	DE2E
	Converts any two adjacent 120/240 Vac 1P side-by-side QOT circuit breakers to independent trip 2P	QOTHT	3.80	DE2E
	Handle tie and lock-off for three 1P QO, QOB circuit breakers	QO3HT	13.40	DE2E
Handle Clamp:	Clamp for holding QO 1P handle in ON or OFF position	QO1LO	3.80	DE2E
	Clamp for holding QO or Q1 1P, 2P or 3P circuit breaker handles in ON or OFF position	HLO1	9.90	DE2E
Handle Padlock Attachment: for Padlocking in ON or OFF position	For padlocking 1P QO circuit breaker in ON or OFF position Loose attachment	QOHPL	9.50	DE2E
	Fixed attachment	QO1PA	10.70	DE2E
	For padlocking 1P side-by-side QOT circuit breaker in ON or OFF position	QOTHPA	11.10	DE2E
	For padlocking 2P and 3P QO-GFI, QO-EPD, and QO-EPE in either ON or OFF position, fixed attachment.	GFI2PA	9.20	DE2A
	For 2P and 3P QO and Q1 standard circuit breakers which require padlocking in either ON or OFF position. Loose attachment	QO1HPL	10.70	DE2E
	Fixed attachment	QO1PL	10.70	DE2E
Handle Padlock Attachment: for Padlocking in OFF position	For padlocking 1P QO circuit breaker in OFF position only, fixed attachment.	QO1PAF	43.50	DE2E
	For padlocking 2P and 3P QO circuit breakers in OFF position only, fixed attachment.	QO2PAF	25.80	DE2E
	For padlocking 1P QO-GFI, QO-AFI, QO-CAFI, and QO-EPD circuit breakers in OFF position only, fixed attachment.	QOGFI1PAF	51.00	DE2E
	For padlocking 2P and 3P QO-GFI, QO-EPD, and QO-EPE circuit breakers in OFF position only, fixed attachment.	QOGFI2PAF	38.40	DE2E
Ring Terminal	Ring terminals are available as a factory-installed option.	See Page 7-10	+20% Price Adder	DE2A
Sub-Feed Lugs	60 A 2P plug-on – 2 spaces required (6–2 Al/Cu)	QO60SL	47.10	DE2A
	125 A 2P plug-on – 2 spaces required (12–2/0 Al/Cu)	QO2125SL	137.00	DE2A
	225 A 2P plug-on – 4 spaces required (4–300 Al/Cu)	QO225SL▲	308.00	DE2A
	125 A 3P plug-on – 3 spaces required (12–2/0 Al/Cu)	QO3125SL	137.00	DE3
Mechanical Interlock Attachment	For interlocking the handles of two 2P or one 2P and one 1P QO and Q1 circuit breakers mounted side-by-side so that only one circuit breaker can be ON at a time (Not QOU)	QO2DTI	24.90	DE2E
With Retaining Kit:	QO2DTI mechanical interlock attachment with retaining kits for securing two adjacent back-fed circuit breakers in dual power supply applications. Can be used with (2) 2Ps or (1) 2P and (1) 1P QO circuit breakers in QO816L100 load centers.	QO2DTIM	63.00	DE2E

▲ Not suitable for use in 3Ø panels. Use only in 1Ø panel rated 150 A or greater.

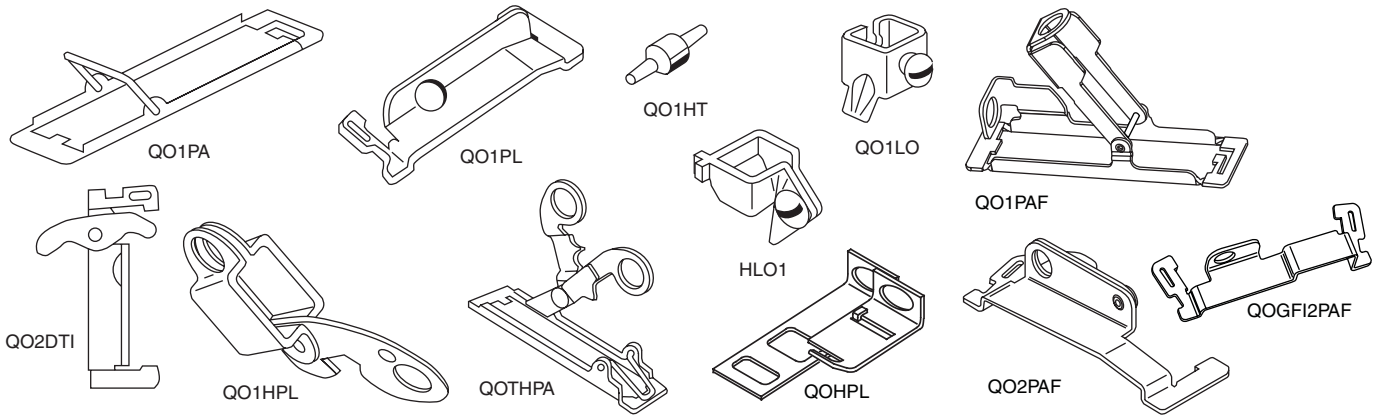

**Factory-Installed Accessories for Use with QO and QOB Miniature Circuit Breakers**

Factory-installed electrical accessories take up an additional pole space on QO®, QO-GFI, QO-EPD, QO-SWN and QOU circuit breakers. All AC electrical accessories shown below are rated for 50/60 Hz. Accessories are not available for QOB-VH (2P 150 A and 3P 110–150 A) circuit breakers or QO, QOU molded case switches. QO circuit breakers will accept only one accessory per circuit breaker. Undervoltage trip is not available on miniature circuit breakers. Factory-installed accessories are not available for QO-AFI or QO-CAFI Arc Fault Circuit Breakers or on QO2150, QO2175, or QO2200 circuit breakers.

**Table 7.15: Factory-Installed Accessories**

Accessory	Description	Rated Voltage	Coil Burden	Cat. No. Suffix	\$ Price Adder	Accessory	Description	Contact Comb.	Max. Voltage	Max. Load	Cat. No. Suffix	\$ Price Adder		
Shunt Trip	Trips the circuit breaker from a remote location by means of a trip coil energized from a separate circuit. A 120 Vac shunt trip will operate at 55% or more of rated voltage. All other shunt trips will operate at 75% or more of rated voltage.  <b>Application</b> • For use with momentary or maintained push button. • Not available on QO-GFI, QO-EPD, QO-AFI, QOCAFI. • Shunt trip terminals accept (2) 14–12 AWG Cu.	AC/DC	12 24	60 VA 168 VA	-1042	Auxiliary Switches	Monitors circuit breaker contact status and provides a remote signal indicating the circuit breaker contacts are OPEN or CLOSED.  <b>Application</b> • Auxiliary switch terminals accept (2) 14–12 AWG Cu leads.	1A 1B	AC 120 AC 120	5 A 5 A	-1200 -1201	189.00		
		AC	120 208 240	72 VA 228 VA 288 VA	-1021							189.00		
		Alarm Switches	Used with control circuits and is actuated only when the circuit breaker has tripped. Standard construction includes a normally-open contact.  <b>Application</b> • Alarm switch terminals accept (2) 14–12 AWG Cu leads.	1A	AC 120							5 A	-2100	132.00
		Alarm Switches	Used with control circuits and is actuated only when the circuit breaker has tripped. Standard construction includes a normally-open contact.  <b>Application</b> • Alarm switch terminals accept (2) 14–12 AWG Cu leads.	1A	AC 120							5 A	-2100	132.00

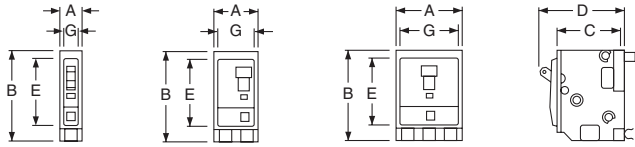

Figure 1 Figure 2 Figure 3 QO, QOB

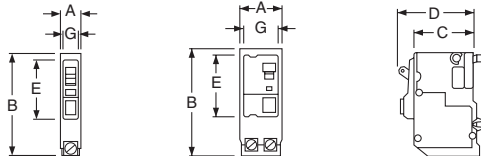

Figure 4 Figure 5 QO-GFI, QO-PL QO-EPD

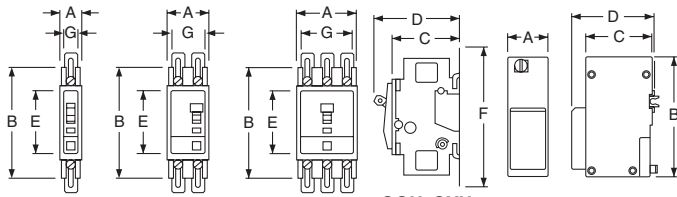

Figure 6 Figure 7 Figure 8 QOU, QYU Low Ampere Figure 9 QO-PLPS

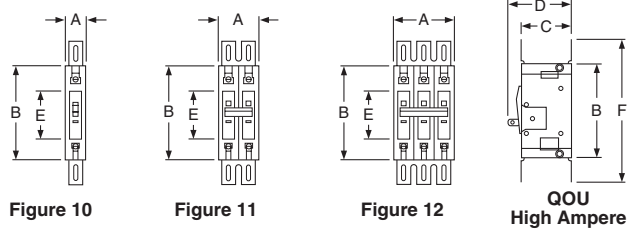

Figure 10 Figure 11 Figure 12 QOU High Ampere

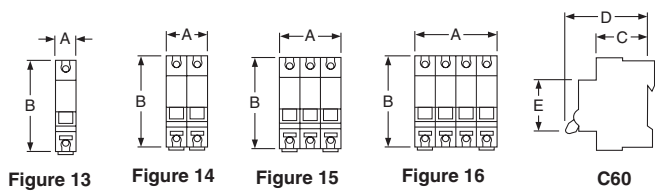

Figure 13 Figure 14 Figure 15 Figure 16 C60

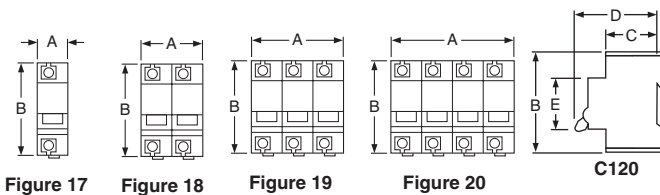

Figure 17 Figure 18 Figure 19 Figure 20 C120

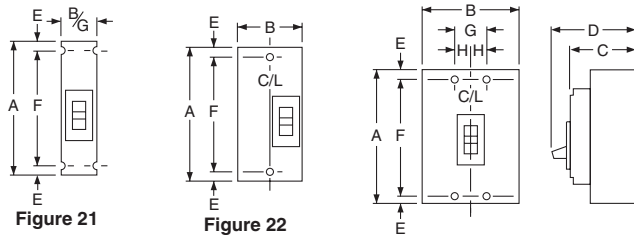

Figure 21 Figure 22 Figure 23

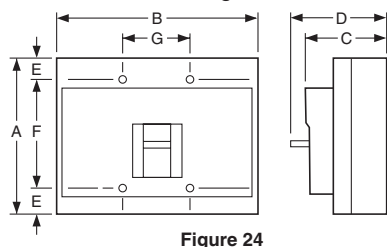

Figure 24

Table 7.140: QO®, QOU, Multi 9™ Circuit Breakers

Circuit Breaker Cat. No. Prefix	Poles	Fig. No.	Dimensions—Inches						
			A	B	C	D	E	F	G
QO, QOB	1	1	0.75	3.00▲	2.31	2.91	2.25	—	0.59
	2	2	1.50	3.00▲	2.31	2.91	2.25	—	1.34
	3	3	2.25	3.00▲	2.31	2.91	2.25	—	2.09
QOB-VH 150 A QOB-VH 110–150 A	2	2	3.0	5.72	2.53	4.90	3.78	—	2.85
	3	3	4.50	5.72	2.53	4.90	3.78	—	4.35
QO-PL QO-GFI QO-EPD	1	4	0.75	4.12■	2.31	2.91	2.25	—	0.59
	2	5	1.50	4.12■	2.31	2.91	2.25	—	1.34
	3	5	2.25	4.12■	2.31	2.91	2.25	—	2.09
QOU QYU Low Ampere	1	6	0.75	4.05♦	2.38	2.98	2.25	5.00★	0.62
	2	7	1.50	4.05♦	2.38	2.98	2.25	5.00★	1.37
	3	8	2.25	4.05★	2.38	2.98	2.25	5.00△	2.12
QOU High Ampere	1	10	0.75	4.45	2.37	2.96	2.25	6.78	—
	2	11	1.50	4.45	2.37	2.96	2.25	6.78	—
	3	12	2.25	4.45	2.37	2.96	2.25	6.78	—
Multi 9™ C60N	1	13	0.71	3.19	1.73	2.76	1.77	—	—
	2	14	1.42	3.19	1.73	2.76	1.77	—	—
	3	15	2.13	3.19	1.73	2.76	1.77	—	—
	4	16	2.84	3.19	1.73	2.76	1.77	—	—
QO-PLPS Power Supply	2	9	1.45	4.35	2.42	3.11	—	—	—

- ▲ 35–70 A is 3.12 in; 80–100 A 2P and 70–100 A 3P are 3.50 in.
- QO-PL is 4.55 in.
- ♦ 80–100 A 1P and 80–125 A 2P are 4.45 in
- ★ 80–100 A 1P and 80–125 A 2P are 6.78 in.
- ▼ 70–100 A 4.45 in.
- △ 70–100 A is 6.78 in.

Table 7.141: QB, QD, QG, QJ, Q4, FA, FI, KA, KC, KI, LA, LC, LI, LE, LX, LXI, MA Circuit Breakers

Circuit Breaker Cat. No. Prefix	Poles	Fig. No.	Dimensions—Inches							
			A	B	C	D	E	F	G	H
QB, QD, QG, QJ	2	22	6.47	3.00	3.02	3.93	□	4.25	—	—
	3	23	6.47	4.50	3.02	3.93	□	4.25	1.50	0.75
FAL, FHL	1	21	6.00	1.50	3.16	4.13	0.44	5.13	1.50	—
	2	22	6.00	3.00	3.16	4.13	0.44	5.13	—	—
	3	23	6.00	4.50	3.16	4.13	0.44	5.13	1.50	0.75
FIL, KAL, KCL, KHL, KIL	2 & 3	23	8.00	4.50	3.66	4.75	0.44	7.13	1.50	0.75
Q4L, LAL, LHL	2 & 3	23	11.00	6.00	4.06	5.84	0.88	9.25	2.00	1.00
LIL, LEL, LXL, LXIL, LCL	2 & 3	24	11.86	7.50	5.48	6.74	0.55	10.75	2.50	—
MAL, MHL	2 & 3	23	14.00	9.00	4.53	6.50	1.66	10.69	3.00	1.50

□ Dimensions E are 1.59 in at ON end and 0.63 in at OFF end.

Table 7.142: Shipping Weights◇

Frame Size	Approx. Shipping Weight (Lbs.)	Frame Size	Approx. Shipping Weight (Lbs.)
FAL, FHL 1P	2	KIL	9
FAL, FHL 2P	3	LAL, LHL	15
FAL, FHL 3P	5	LEL, LIL, LXL, LXIL, LCL	25
FIL	8	Q4L	15
QB, QD, QG, QJ	4	MAL, MHL	34
KAL, KHL	7		

◇ All weights are for 3P circuit breakers unless otherwise noted.

**INTRODUCTION**

**CLASS IV**

Exchange of permanent trip circuit breakers (KA, LA, MA or NA) furnished in lieu of circuit breakers specified with interchangeable trip. These circuit breakers can be identified by a label stating that they are subject to this exchange policy.

**Allowance**

A replacement circuit breaker within the same frame size, but of a different trip rating than that exchanged, is furnished at the lowest recognized competitive list price for a trip unit of the same frame size and trip rating minus the regular discount. This exchange arrangement requires that the replaced circuit breaker be returned to Square D.

**CATALOG NUMBERS**

Square D circuit breakers are ordered by a catalog number that includes the breaker family, description, poles, voltage rating, amperage rating and suffix.

Figure 5 shows a catalog number broken down by components. For example, FAL36050V2100, a typical catalog number, can be broken down as follows:

- FA 100A frame circuit breaker
- L Circuit breaker with lugs on both ends
- 3 Number of poles
- 6 Voltage rating
- 050 Continuous current amperage rating (handle rating)
- V and 2100 V indicates the Visi-Blade feature and the 2100 indicates a factory installed contact alarm. These two components are the suffix.

**TYPICAL CATALOG NUMBER:**

	FA	L	3	6	050	V	2100
<b>BREAKER FAMILY</b>	<p>NOTE: "A" is replaced by letter "H" for High Interrupting                      "A" is replaced by letter "C" for Extra High Interrupting                      "A" is replaced by letter "I" for Current Limiting. (FA, KA, LA circuit breakers only)</p>						
<b>DESCRIPTION</b>	<p>NO LETTER - (I-LINE®) Plug-On Breaker                      B - (I-LINE) Bolt-On Breaker (400 ampere frame maximum)                      F - Terminal Pads Only (No Lugs)                      L - Lugs on Both Ends (Merchandised — Universal Breaker)                      P - Lugs OFF End Only                      R - Plug-On Breaker (I-LINE Type DO with Plug-On Line &amp; Load Connectors)</p>						
<b>POLES</b>	<p>1 - 1-Pole                      2 - 2-Pole                      3 - 3-Pole</p>						
<b>VOLTAGE RATING</b>	<p>2 - 240Vac                      4 - 480Vac                      6 - 600Vac</p>						
<b>AMPERE RATING</b>	<p>015 - 090 - 15-90 Ampere Rating                      100 - 900 - 100-900 Ampere Rating                      1000 - 1200 - 1000-1200 Ampere Rating                      000 or 0000 - Molded Case Switch                      000X or 000XX - Molded Case Switch</p>						
<b>SUFFIX</b>	<p>The suffix indicates a special feature of the circuit breaker.</p> <ul style="list-style-type: none"> <li>A, B, C - indicates I-LINE® Phase Connections</li> <li>V - indicates Visi-Blade</li> <li>M - indicates Automatic Molded Case Switch</li> <li>XXM - indicates Instantaneous Trip only (MAG-GARD®) (i.e., 18M is 300-1100A adjustable trip range)</li> <li>XXT - indicates adjustable magnetic trip with responsive thermal (mining breakers)</li> <li>G - indicates Ground Fault Shunt Trip accessory</li> <li>XXXX - i.e., 2100 indicates a factory installed accessory</li> </ul>						

FIGURE 5  
CATALOG NUMBERING SYSTEM FOR THERMAL-MAGNETIC MOLDED CASE CIRCUIT BREAKERS

