

**1A 1B**  
**INTERIOR ELEVATIONS 1**  
 HC TOILET ROOM 108 SCALE: 3/8"=1'-0" A-4.02

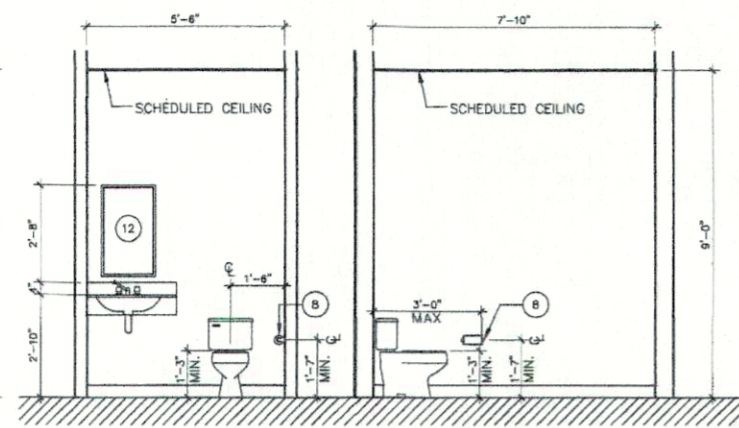

**2A 2B**  
**INTERIOR ELEVATIONS 2**  
 STAFF TOILET ROOM 104 SCALE: 3/8"=1'-0" A-4.02

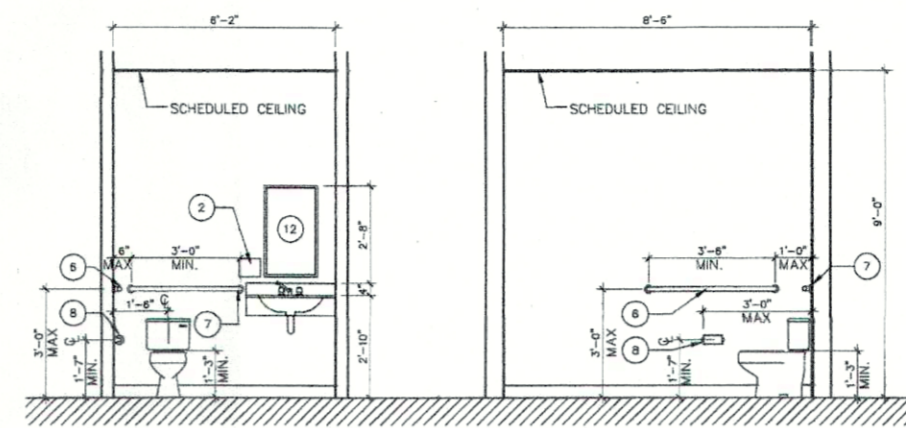

**3A 3B**  
**INTERIOR ELEVATIONS 3**  
 STAFF HC TOILET ROOM 148 SCALE: 3/8"=1'-0" A-4.02

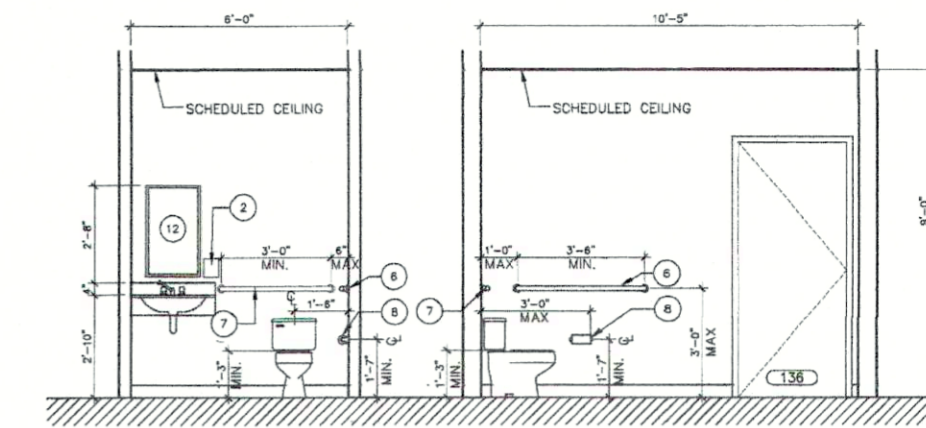

**4A 4B**  
**INTERIOR ELEVATIONS 4**  
 FEMALE HC TOILET ROOM 136 SCALE: 3/8"=1'-0" A-4.02

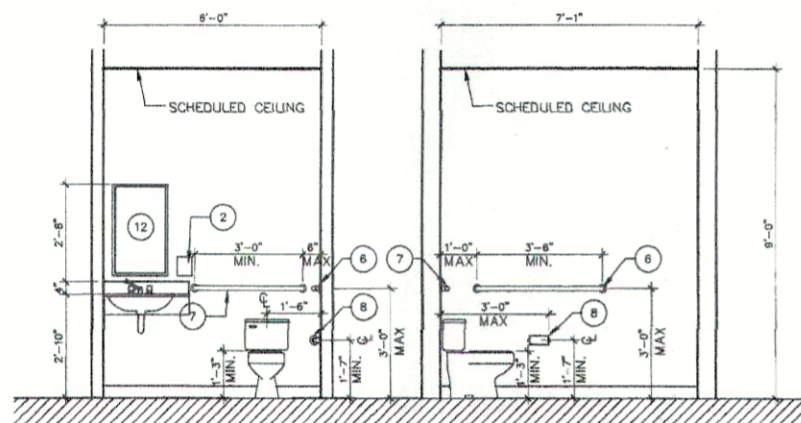

**5A 5B**  
**INTERIOR ELEVATIONS 5**  
 MALE HC TOILET ROOM 135 SCALE: 3/8"=1'-0" A-4.02

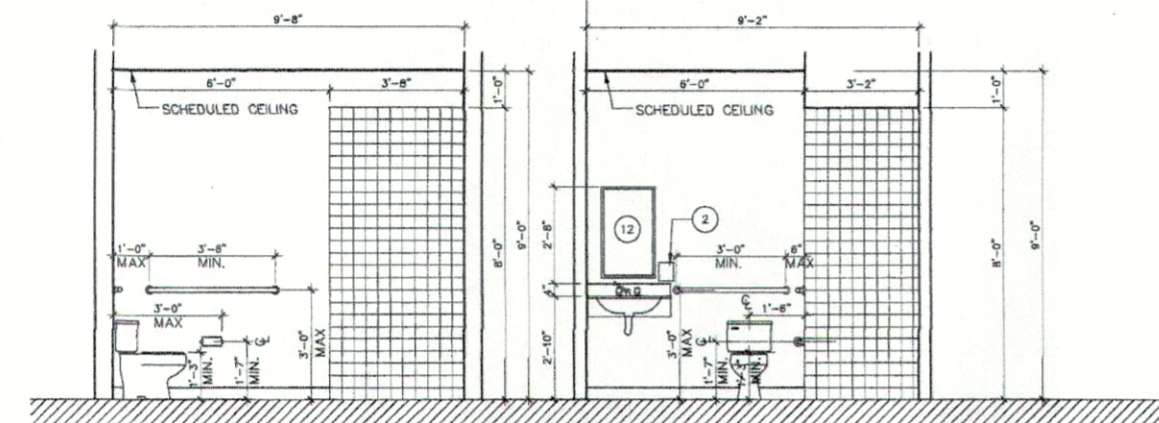

**6A 6B**  
**INTERIOR ELEVATIONS 6**  
 DOCTOR'S SHOWER ROOM 126 SCALE: 3/8"=1'-0" A-4.02

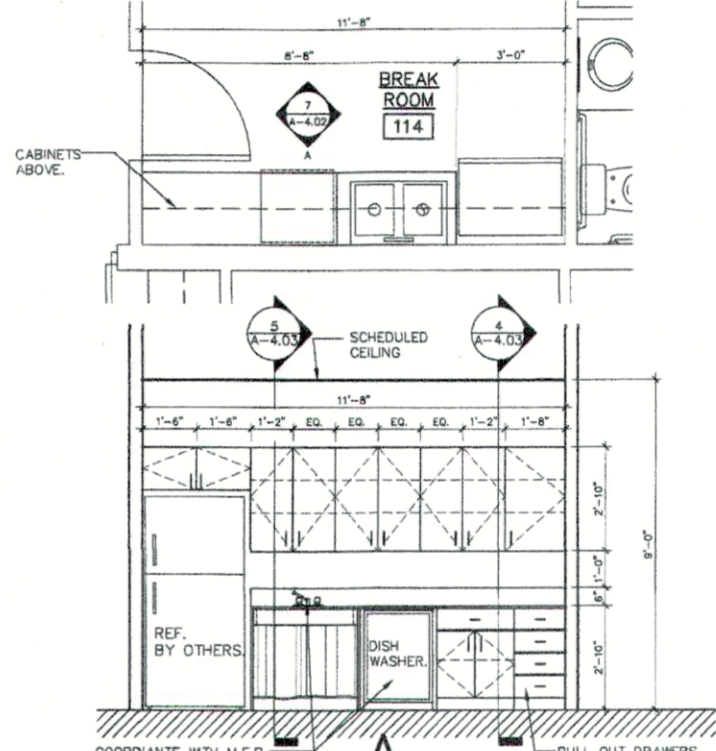

**BREAK ROOM 114 7**  
 ENL. PLAN AND INT. ELEV. SCALE: 3/8"=1'-0" A-4.02

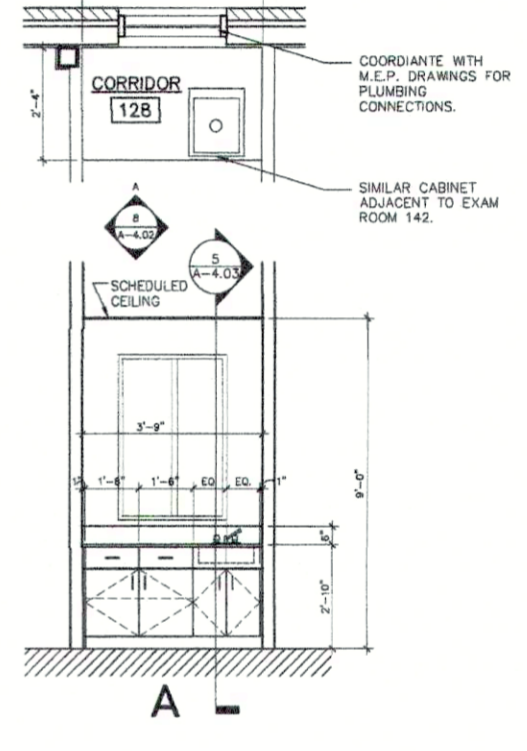

**CORRIDOR 128 8**  
 ENLARGED PLAN AND INT. ELEV. SCALE: 3/8"=1'-0" A-4.02

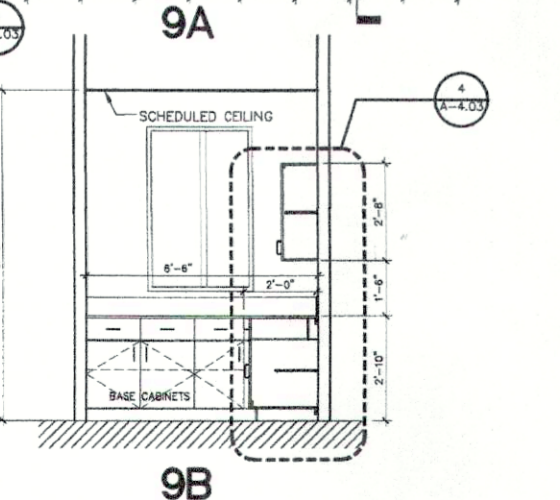
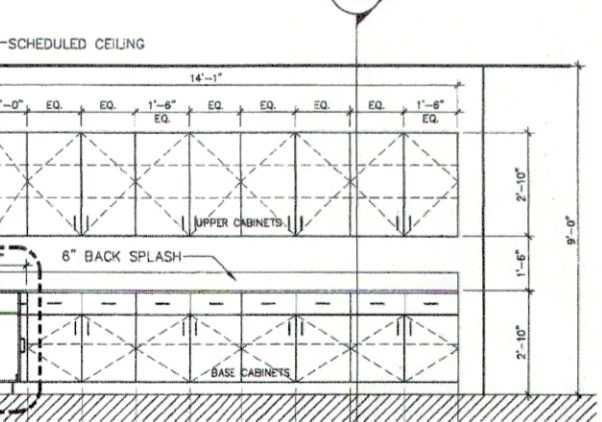
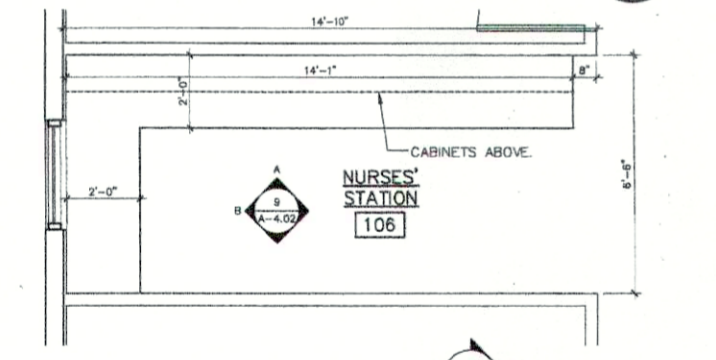

**NURSES' STATION 106 9**  
 ENLARGED PLAN AND INT. ELEV.S SCALE: 3/8"=1'-0" A-4.02

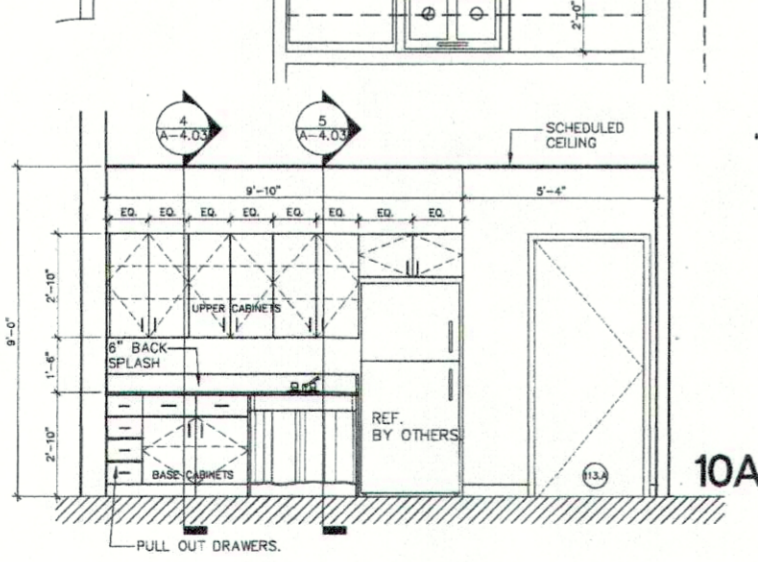
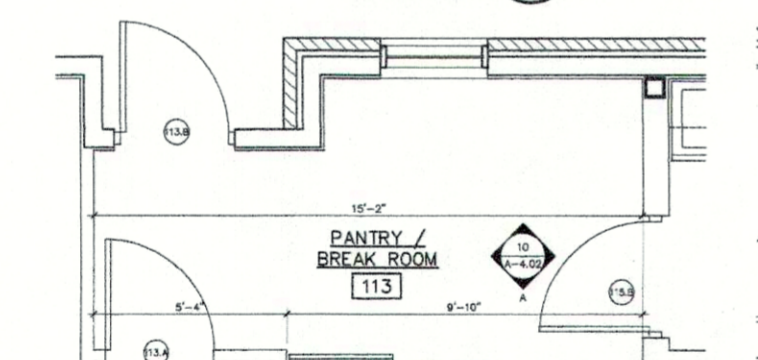

**PANTRY / BREAK ROOM 113 10**  
 ENLARGED PLAN AND INT. ELEV.S SCALE: 3/8"=1'-0" A-4.02

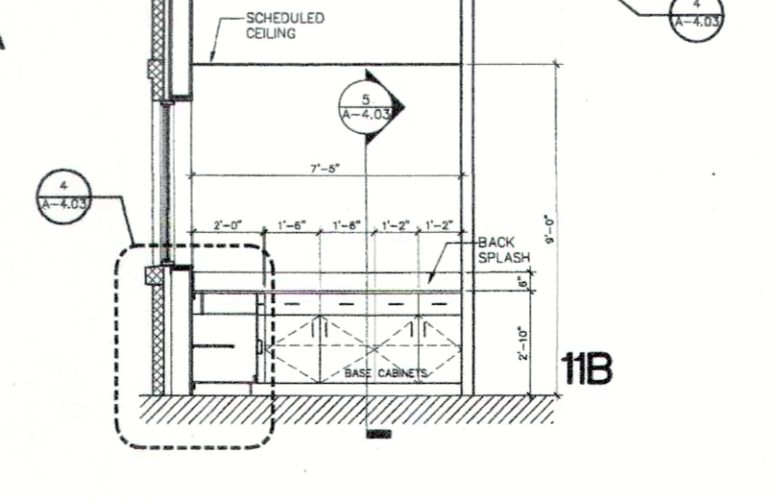
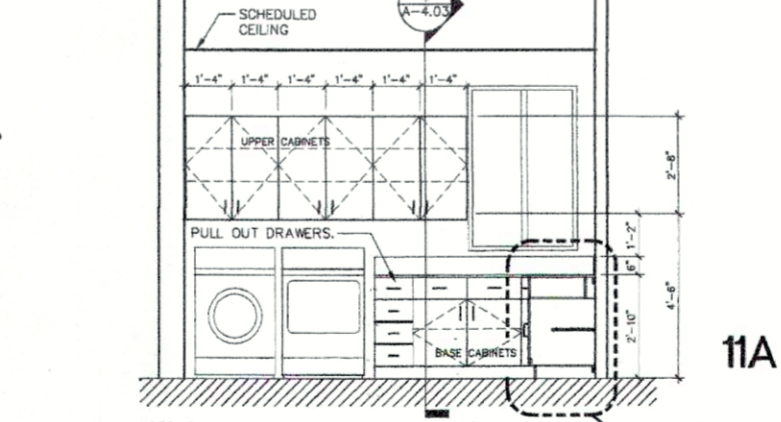
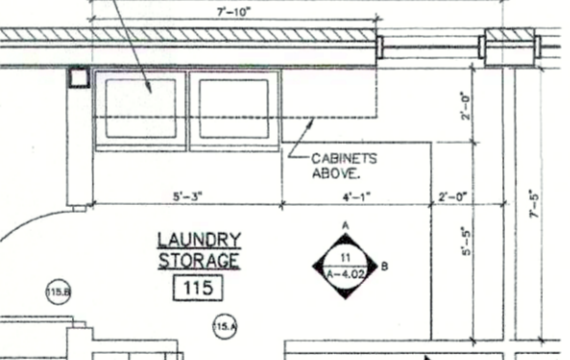

**LAUNDRY STORAGE 115 11**  
 ENLARGED PLAN AND INT. ELEV.S SCALE: 3/8"=1'-0" A-4.02

**PROGRESS SET**

**BID SET**

**FLAME SPREAD NOTE:**  
 ALL INTERIOR FINISHES INCLUDING WALLS, PARTITIONS, CEILINGS AND OTHER EXPOSED INTERIOR SURFACES, COMPRISING BOTH PLASTER, WOOD OR OTHER INTERIOR FINISH MATERIAL AND ANY SURFACING MATERIAL SUCH AS PAINT OR WALL PAPER APPLIED THEREOF SHALL HAVE A FAME SPREAD CLASSIFICATION OF CLASS A.

<p><b>ARCHITECT</b>  <b>SATNOH, LLC</b>        180 W. RUELLIE        MANDEVILLE, LA 70471</p>																																									
<p><b>STATE REG. # 628</b></p>																																									
<p><b>ARCHITECT</b>  <b>GARCIA BRENNER STROMBERG</b>        ARCHITECTS        1000 Poydras Street, Suite 1100        New Orleans, Louisiana 70112        Tel: 504.581.1075 Fax: 504.581.2414        www.gbbsc.com</p>	<p><b>PROJECT #</b> 0400  <b>DATE</b> 11/20/02</p>																																								
<p><b>INTERIOR ELEVATIONS AND DETAILS</b></p>																																									
<p><b>TULANE / HONTAS MEDICAL CENTER</b></p>																																									
<p><b>PROJECT #</b> 0400  <b>DATE</b> 11/20/02</p>																																									
<p><b>REVISIONS</b></p> <table border="1"> <tr><td>1</td><td></td></tr> <tr><td>2</td><td></td></tr> <tr><td>3</td><td></td></tr> <tr><td>4</td><td></td></tr> <tr><td>5</td><td></td></tr> <tr><td>6</td><td></td></tr> <tr><td>7</td><td></td></tr> <tr><td>8</td><td></td></tr> <tr><td>9</td><td></td></tr> <tr><td>10</td><td></td></tr> <tr><td>11</td><td></td></tr> <tr><td>12</td><td></td></tr> <tr><td>13</td><td></td></tr> <tr><td>14</td><td></td></tr> <tr><td>15</td><td></td></tr> <tr><td>16</td><td></td></tr> <tr><td>17</td><td></td></tr> <tr><td>18</td><td></td></tr> <tr><td>19</td><td></td></tr> <tr><td>20</td><td></td></tr> </table>		1		2		3		4		5		6		7		8		9		10		11		12		13		14		15		16		17		18		19		20	
1																																									
2																																									
3																																									
4																																									
5																																									
6																																									
7																																									
8																																									
9																																									
10																																									
11																																									
12																																									
13																																									
14																																									
15																																									
16																																									
17																																									
18																																									
19																																									
20																																									
<p><b>A-4.02</b></p>																																									