



Openings in Foundation Walls and Walls of Enclosures

Below Elevated Buildings in Special Flood Hazard Areas
in accordance with the National Flood Insurance Program

Technical Bulletin 1 / August 2008



FEMA

Table of Contents

Introduction	1
NFIP Regulations	4
How Openings Affect Flood Insurance Rates	4
Documenting Elevations and Information About Openings	5
Enclosed Areas Below Elevated Buildings.....	5
Enclosures That Require Openings.....	6
Situations That Do Not Require Openings.....	12
Requirements and Guidance for Installation of Openings.....	13
Minimum Number of Openings.....	13
Height of Openings Above Grade	14
Installation Examples	15
Non-Engineered Openings and Engineered Openings.....	18
Unacceptable Measures.....	19
Non-Engineered Openings	20
Engineered Openings	24
The NFIP	28
NFIP Technical Bulletins	28
Ordering Technical Bulletins	28
Further Information	29
Glossary	30

Comments on the Technical Bulletins should be directed to:

Department of Homeland Security
FEMA Mitigation Directorate
500 C Street, SW.
Washington, D.C. 20472

Technical Bulletin 1-08 replaces Technical Bulletin 1-93, *Openings in Foundation Walls*.

Photograph Credits:

Figure 3. Bill Bryant, Anne Arundel County, Maryland
Figure 4. Smart Vent, Inc.
Figure 17. North Carolina Emergency Management/T. Riddle

Introduction

Protecting buildings that are constructed in special flood hazard areas (SFHAs) from damage caused by flood forces is an important objective of the National Flood Insurance Program (NFIP). In support of this objective, the NFIP regulations include minimum building design criteria that apply to new construction, repair of substantially damaged buildings, and substantial improvement of existing buildings in SFHAs. The base flood is used to delineate SFHAs on Flood Insurance Rate Maps (FIRMs) prepared by the NFIP. The base flood is the flood that has a 1-percent chance of being equaled or exceeded in any given year (commonly called the "100-year" flood). Certain terms used in this Technical Bulletin are defined in the Glossary.

The NFIP regulations require that residential buildings constructed in A zones have the lowest floor (including basement) elevated to or above the base flood elevation (BFE). In this Technical Bulletin, the term "A zones" includes all zones shown on FIRMs as Zones A, AE, A1-A30, AR, AO, and AH.

Enclosed areas (enclosures) are permitted under elevated buildings provided the enclosed areas meet certain use restrictions and construction requirements related to flood resistance, including use of flood damage-resistant materials and installation of openings to allow for automatic entry and exit of floodwaters. Enclosures under buildings in V zones (includes all Zones V, VE, and V1-V30) must meet the same enclosure requirements except that openings are not required and walls must be non-supporting breakaway walls, open lattice-work, or insect screening (see Technical Bulletin 9, *Design and Construction Guidance for Breakaway Walls Below Elevated Coastal Buildings*).

The NFIP regulations for new construction and substantial improvements of existing buildings require that enclosed areas under elevated non-residential buildings meet the same requirements as those for enclosures under elevated residential buildings. New non-residential buildings constructed in A zones, and substantial improvements of existing non-residential buildings, must either have their lowest floors elevated to or above the BFE or be floodproofed (made watertight) to or above the BFE.

Many types of foundations are used to elevate buildings. While the main portions of elevated buildings are above the BFE, the foundation and any enclosed areas below the BFE will be exposed to flood forces. Enclosed areas below the BFE

Under the NFIP, the "lowest floor" is the floor of the lowest enclosed area of a building. An unfinished or flood-resistant enclosure that is used solely for parking of vehicles, building access, or storage is not the lowest floor, provided the enclosure is built in compliance with applicable requirements.

As used by the NFIP, an "enclosure" is an area that is enclosed on all sides by walls.

The NFIP defines a "basement" as any area that is below-grade on all sides. The regulations do not allow basements to extend below the BFE.

Owners of existing elevated buildings with enclosures below the BFE may wish to retrofit the enclosures. Lower NFIP flood insurance rates may apply if the retrofit enclosures have openings that meet the requirements in this Technical Bulletin and also meet other requirements for enclosures (limited use, flood damage-resistant materials, and elevated utilities).

(including crawlspaces) are permitted if used only for parking of vehicles, building access, and storage. Figure 1 illustrates a typical crawlspace foundation wall and a typical framed wall surrounding an enclosed area.

If enclosure walls are not designed with openings to relieve the pressure of standing or slow-moving water against them (called hydrostatic loads), the walls can be damaged or fail during a flood. If the walls are "load-bearing" walls that support the elevated building, failure of the walls may result in damage to, or collapse of, the building. To address this concern, the NFIP regulations require that enclosure walls contain openings that will allow for the automatic entry and exit of floodwaters. These openings allow floodwaters to reach equal levels on both sides of the walls, thereby lessening the potential for damage caused by a difference in hydrostatic loads on opposite sides of the walls. In A zones, the requirement for flood openings applies to all enclosed areas below new elevated buildings and below substantially improved buildings.

Areas of shallow flooding may be shown as AO zones on FIRMs. Rather than BFEs, AO zones have "flood depths" that range from 1 to 3 feet. In these zones, all NFIP requirements related to BFEs apply, including elevation of the lowest floor to or above the designated flood depth and requirements for enclosures with flood openings that are located so that floodwaters will flow in and out.

This Technical Bulletin explains the NFIP requirements for flood openings and provides guidance for prescriptive (non-engineered) openings and engineered openings. Non-engineered openings are used to meet the NFIP's prescriptive requirement of 1 square inch of net open area for every square foot of enclosed area. As an alternative, engineered openings that have characteristics that differ from non-engineered openings may be used provided they are designed and certified by a registered design professional as meeting certain performance characteristics described in this Technical Bulletin.

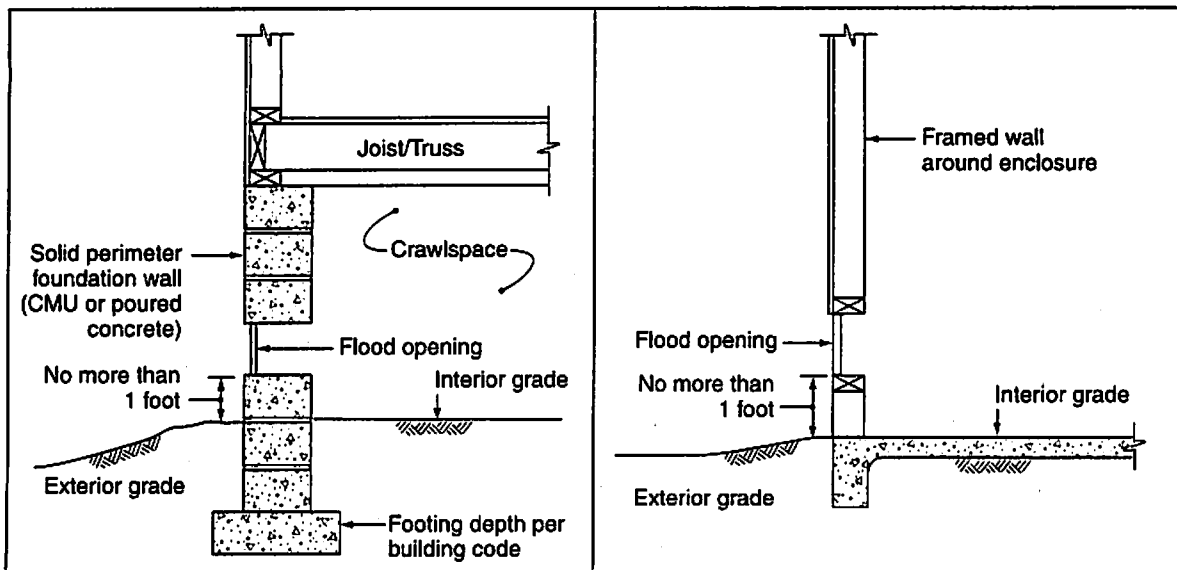

Figure 1. Typical enclosures with flood openings

This Technical Bulletin also discusses how openings could affect flood insurance premiums, provides examples of enclosures that require openings and situations where openings are not required, and outlines the requirements for, and provides guidance, on the following:

- Installation of openings, including the minimum number of openings and height of openings above grade,
- Non-engineered openings, and
- Engineered openings.

Examples are provided to illustrate types of buildings and enclosures that require openings, and to address several commonly encountered situations. Other situations may require the advice of a registered design professional. Questions should be directed to the appropriate local official, NFIP State Coordinating Office, or FEMA Regional Office.

Solid perimeter foundation walls and walls surrounding enclosed areas below the BFE may be damaged by forces related to moving floodwaters and wave impacts (called hydrodynamic loads), and debris impacts. The requirement for openings is intended to reduce only flood damage associated with hydrostatic – not hydrodynamic – loads.

Hydrodynamic loads and debris impacts may be significant in some flood hazard areas shown as A zones on FIRMs, including riverine areas where high flow velocities are likely (e.g., faster than 5 feet per second) and areas where wave heights of 1.5 feet or more are possible. In these areas, it is recommended that a registered design professional evaluate foundation designs. Open foundations without enclosed areas are less vulnerable to the type of damage that can be caused by high flow velocities and wave action.

This Technical Bulletin discusses openings in walls below the BFE. Readers should check with the community to determine whether a higher elevation standard is enforced. For example, communities may add freeboard or may regulate to the design flood elevation (DFE). In those cases, references to the BFE in this Technical Bulletin should be construed as references to the community's elevation requirement.

Buildings in V zones (Zones V, VE, and VI-V30) must meet certain design and construction requirements that are specified in the NFIP regulations at Section 60.3(e). The area below the lowest floors of buildings in V zones must be free of obstruction or, if enclosed, the walls of enclosures must be constructed with non-supporting breakaway walls, open wood lattice-work, or insect screening. Openings may be provided, but are not required, in breakaway walls under buildings in V zones. For information on V-zone design and construction requirements, refer to the NFIP regulations, the Technical Bulletin series (especially Technical Bulletin 5, *Free-of-Obstruction Requirements* and Technical Bulletin 9, *Design and Construction Guidance for Breakaway Walls Below Elevated Coastal Buildings*), the *Coastal Construction Manual* (FEMA 55CD), *Flood Resistant Design and Construction* (ASCE 24), and *Home Builder's Guide to Coastal Construction* (FEMA 499).

NFIP Regulations

The NFIP regulations for enclosures are codified in Title 44 of the Code of Federal Regulations, in Section 60.3(c)(5), which states that a community shall:

“Require, for all new construction and substantial improvements, that fully enclosed areas below the lowest floor that are usable solely for parking of vehicles, building access, or storage in an area other than a basement and which are subject to flooding shall be designed to automatically equalize hydrostatic flood forces on exterior walls by allowing for the entry and exit of floodwaters. Designs for meeting this requirement must either be certified by a registered professional engineer or architect or meet or exceed the following minimum criteria: A minimum of two openings having a total net area of not less than one square inch for every square foot of enclosed area subject to flooding shall be provided. The bottom of all openings shall be no higher than one foot above grade. Openings may be equipped with screens, louvers, valves, or other coverings or devices provided that they permit the automatic entry and exit of floodwaters.”

Proposals for substantial improvement of existing buildings in SFHAs, and proposals to repair those that have sustained substantial damage, must comply with the requirements for new construction. In A zones, the applicable requirements include openings in the walls surrounding enclosed areas below the BFE. As part of issuing permits, community officials must review such proposals to determine whether they comply with the requirements. Further information on substantial improvement and substantial damage is found in *Answers to Questions About Substantially Damaged Buildings* (FEMA 213).

The NFIP Technical Bulletins provide guidance on the minimum requirements of the NFIP regulations. Community or State requirements that exceed those of the NFIP take precedence. Design professionals should contact the community to determine whether more restrictive provisions apply to the building or site in question. All other applicable requirements of the State or local building codes must also be met for buildings in flood hazard areas.

How Openings Affect Flood Insurance Rates

Careful attention to compliance with the NFIP regulations for flood openings is important during design, plan review, construction, and inspection. Compliance influences both the vulnerability to flood damage and the cost of NFIP flood insurance. If openings are not compliant, the floor of the crawlspace or the floor of the enclosure becomes the “lowest floor.” In those cases, the result may be significantly higher flood insurance premiums, especially if the floor of the crawlspace or enclosure is more than a foot or two below the BFE.

Documenting Elevations and Information About Openings

Communities are required to collect data from permittees to document the surveyed elevation of the lowest floors of new buildings and existing buildings that are substantially improved. Although the data may be provided in other formats, the NFIP's Elevation Certificate (FEMA Form 81-31) is designed specifically for this purpose. The current version of the Elevation Certificate is online at <http://www.fema.gov/business/nfip/elvinst.shtm>.

The Elevation Certificate is designed to collect information that facilitates determining compliance of new construction and to provide data necessary for the proper rating of NFIP flood insurance. For guidance, see the instructions that accompany the Elevation Certificate and the *Floodplain Management Bulletin: Elevation Certificate* (FEMA 467-1).

The Elevation Certificate has blanks that are to be completed if there are enclosures under elevated buildings, including:

- The square footage of the enclosed area,
- The number of flood openings within 1.0 foot above adjacent grade, and
- The total net area of flood openings.

The Elevation Certificate provides space for comments. As noted above and explained in more detail below, the regulations provide two ways to satisfy the requirements for openings. Comments should be provided when engineered openings are used, and when there are other aspects of enclosures and openings that comply with the requirements but that, without close inspection, may appear to be non-compliant. The documentation required for engineered openings should be attached to the Elevation Certificate (described on page 25, Documentation of engineered openings for flood insurance).

Enclosed Areas Below Elevated Buildings

The NFIP regulations specify that enclosed areas under elevated buildings may be allowed provided the enclosed areas are used solely for:

- Parking of vehicles (attached garages or parking areas below elevated buildings)
- Building access (stairwells, foyers, elevators)
- Storage (low-value items)

Although crawlspaces are not listed explicitly as an allowable use, buildings may be elevated using perimeter foundation walls that create enclosed areas, typically called crawlspaces or under-floor spaces. Crawlspaces provide access to under-floor utilities such as pipes, ductwork, and electric conduits.

Some communities require permittees to execute a "non-conversion" agreement to document their understanding that the use of enclosures is limited, that conversion to other uses is not allowed, and that modification of enclosures may result in higher NFIP flood insurance rates.

It is important to understand how an otherwise compliant enclosed area below the BFE can be rendered non-compliant by installing features that are not consistent with the limitations on uses. The following are not allowed below the BFE because of potential damage and their presence is inconsistent with the allowed uses: appliances, heating and cooling equipment, plumbing fixtures, more than the minimum electric service required to address life safety and electric code requirements for building access and storage areas, and materials that are not flood damage-resistant.

The only exception to the openings requirement is for non-residential buildings that are engineered to be floodproofed by meeting stringent requirements to be watertight. For information on floodproofing, refer to Technical Bulletin 3, *Non-Residential Floodproofing – Requirements and Certification*.

The NFIP regulations require that enclosed areas surrounded by solid walls that extend below the BFE have flood openings. The requirement applies whether the walls are load-bearing walls or non-load-bearing walls. Therefore, openings are required in solid perimeter foundation walls that surround crawlspaces and openings are required in the walls of fully enclosed areas that meet the use limitations (parking of vehicles, building access, or storage). The requirement applies to new construction and to buildings that are undergoing substantial improvement, including repair of substantial damage.

Enclosures That Require Openings

Several examples of enclosures that require openings are described below:

- Solid perimeter foundation walls (crawlspaces or under-floor spaces)
- Solid perimeter foundation walls (below-grade crawlspaces)
- Solid perimeter foundation walls (with full-height under-floor spaces)
- Garages attached to elevated buildings
- Enclosed areas under buildings elevated on open foundations in A zones
- Enclosed areas with breakaway walls under buildings elevated on open foundations in A zones
- Solid perimeter foundation walls on which manufactured homes are installed
- Accessory structures (detached garages and storage sheds)

Solid perimeter foundation walls (crawlspaces or under-floor spaces)

The crawlspace or under-floor space that is created when a building is elevated on a solid perimeter foundation wall is an enclosed area below the BFE that must meet all of the requirements for enclosed areas (refer to Figure 1). If a brick veneer, siding, or other material covers the wall, then the openings must completely penetrate into the enclosed area. A crawlspace access with a door does not qualify as a flood opening unless

In many parts of the country, a common practice is to build "conditioned crawlspaces" that are sealed and have mechanical ventilation. In SFHAs, all crawlspaces must have flood openings that meet the requirements of the NFIP and the building codes.

the door has an opening installed in it or otherwise meets the performance requirement that it will allow automatic entry and exit of floodwaters.

As explained on page 14 (Height of Openings Above Grade), the bottom of each opening is to be located no higher than 1 foot above the higher of the final interior or exterior grades under the opening. Therefore, placement of the openings in the foundation wall requires knowledge of the expected finished exterior grade and the final interior grade of the crawlspace.

Building code requirements may call for ventilation of certain under-floor spaces. Ventilation openings typically are positioned near the top of the foundation wall to facilitate air flow. In most cases, ventilation openings will be too high above grade to satisfy the requirements for flood openings.

Solid perimeter foundation walls (below-grade crawlspaces)

The NFIP regulations do not allow buildings to be constructed with areas that are below grade on all sides (basements), except for certain engineered non-residential buildings that are designed and certified to be floodproofed. Therefore, crawlspaces that are below-grade on all sides are not allowed because they are basements. An exception is available only in shallow floodplains, and then only if certain other requirements and limitations are met. Those requirements and limitations are detailed in Technical Bulletin 11, *Crawlspace Construction for Buildings Located in Special Flood Hazard Areas: National Flood Insurance Program Interim Guidance*. According to this guidance, below-grade crawlspaces may be allowed provided the wall height is less than 4 feet when measured from bottom of the floor joist/truss to the top of footing, which must be no more than 2 feet below-grade (see Figure 2). Flood openings are required in the foundation walls surrounding these crawlspaces and, as noted above, air ventilation may be required.

Although crawlspaces that satisfy the limitations in TB 11 are not considered basements for floodplain management purposes, it is important to note that they are basements for NFIP flood

Communities are required to adopt specific provisions in their ordinances to be consistent with the limitations in TB 11 in order to permit below-grade crawlspaces.

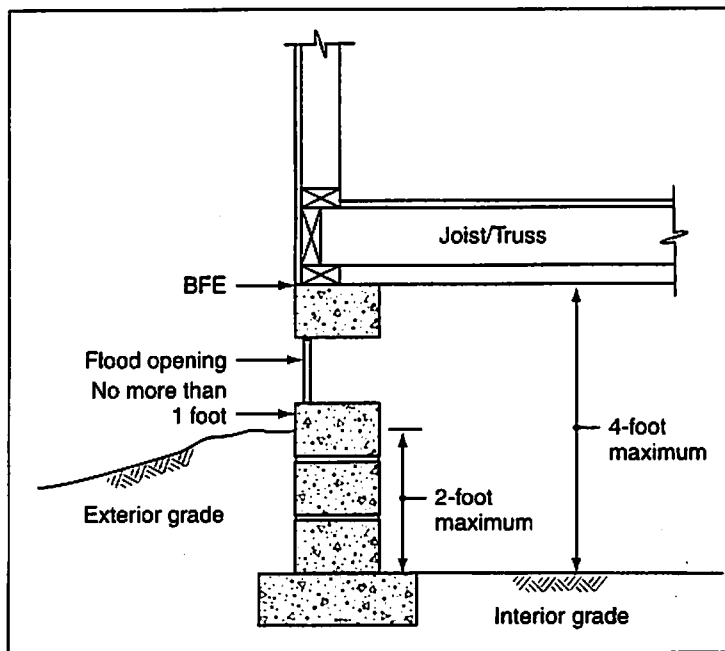

Figure 2. Limitations on below-grade crawlspaces in shallow flood hazard areas (TB 11)

insurance purposes. Therefore, NFIP flood insurance will be more expensive if the grade inside the crawlspace is below the exterior grade on all sides. In addition, below-grade crawlspaces may contribute to increased humidity and mold growth. TB 11 requires that an adequate drainage system be provided in order to minimize floodwater contact with crawlspace materials and related moisture damage.

Solid perimeter foundation walls (with full-height under-floor spaces)

In SFHAs where the BFE is more than 4 or 5 feet above grade, or where owners want enough head room to allow for parking of vehicles and storage, solid perimeter foundation walls may be used to create full-height under-floor spaces (see Figure 3). The walls surrounding the under-floor space must meet all of the opening requirements.

It is important that full-height under-floor spaces also meet all other NFIP requirements to minimize the likelihood of future conversion to uses other than the allowed uses (parking of vehicles, building access, or storage). As noted in the discussion of limitations on uses of enclosures, the following are not allowed below the BFE in full-height enclosures because of potential damage and their presence is inconsistent with the allowed uses: appliances, heating and cooling equipment, plumbing fixtures, more than the minimum electric service required to address life safety and electric code requirements for building access and storage areas, and materials that are not flood damage-resistant.

Figure 3. Full-height solid perimeter walls surrounding garage and storage area (only two openings visible)



Garages attached to elevated buildings

Many buildings, especially homes, are designed with attached garages. An attached garage may have its floor below the BFE provided the garage meets all of the requirements for an enclosed area below the BFE. The use of the garage space must be limited to parking of vehicles, building access, and storage.

Openings are required in the exterior walls of the garage, and openings may be installed in exit doors and garage doors (see Figure 4). It is important to note that garage doors themselves do not meet the requirements for openings. Human intervention would be necessary to open garage doors when flooding is expected, which is inconsistent with the requirement that openings allow for the automatic entry and exit of floodwaters. Similarly, gaps that may be present between the garage door and the door jamb or walls do not guarantee automatic entry and exit of floodwaters and do not count towards the net open area requirement.

If an attached garage is built with its floor below the BFE and it does not have compliant openings, the garage floor becomes the lowest floor. Flood insurance premiums may be significantly higher than if the garage complies with the requirements for openings and other requirements, such as flood damage-resistant materials and elevated utilities.

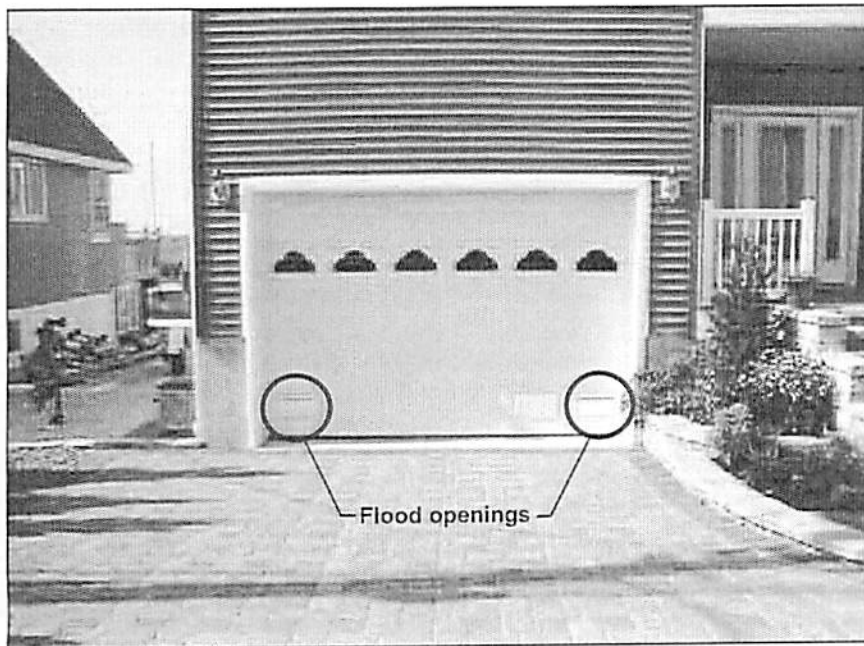

Figure 4. Attached garage, with engineered openings installed in the garage door

Enclosed areas under buildings elevated on open foundations in A zones

A building that is elevated on an open foundation (e.g., piers, posts, columns, or pilings) in an A zone may have enclosed areas below the elevated floor (see Figure 5). Sometimes only part of the footprint is enclosed, such as for a stairwell or storage room. All of the requirements for enclosed areas apply, including openings, elevated utilities, flood damage-resistant materials, and limitations on use (parking of vehicles, building access, and storage).

Open foundations are recommended in riverine flood hazard areas where flow velocities are expected to exceed 5 feet per second because of the anticipated hydrodynamic loads and potential for debris impact and scour. These loads may be sufficient to damage typical solid perimeter foundation walls, even though flood openings are provided.

ASCE 24 and several of the fact sheets included in the *Home Builder's Guide to Coastal Construction* (FEMA 499) are excellent resources for flood-resistant building methods in coastal A hazard areas.

If a waterway was studied using detailed methods and a floodway is shown on a FIRM, then the Floodway Data Table in the Flood Insurance Study should be reviewed for data that can be used to estimate velocities. For each cross section, the table provides the mean velocity that can be used to approximate velocities in the floodplain outside of the floodway. For other waterways in areas known to have fast-moving water, standard methods can be used to compute an approximate velocity. Examples of other sources of information that should be reviewed include local observations and studies prepared by State and local agencies.

Figure 5. Enclosure with flood openings, under house elevated on pilings

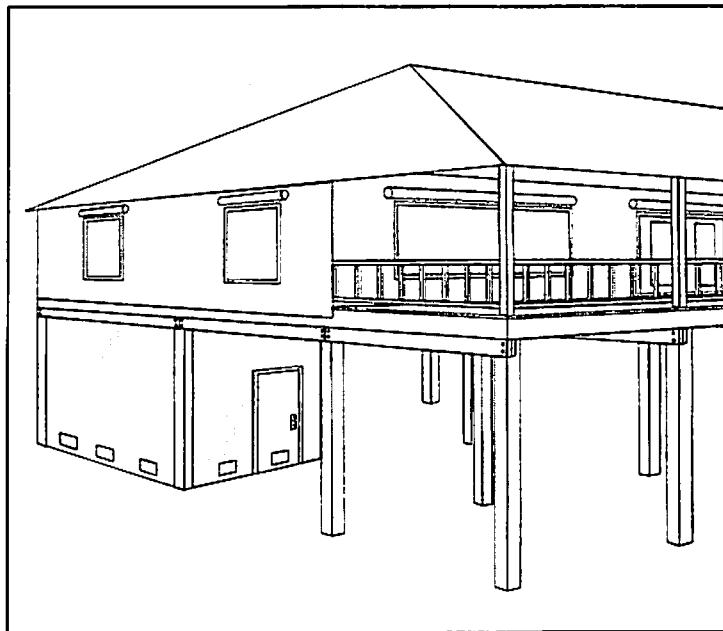

Enclosed areas with breakaway walls under buildings elevated on open foundations in A zones

Open foundations also are recommended in A zones in coastal areas where breaking wave heights can be between 1.5 and 3.0 feet (called Coastal A Zones). In these areas, it is recommended that walls surrounding enclosed areas be designed as breakaway walls. Flood openings are required in breakaway walls in A zones in order to comply with the NFIP requirements. ASCE 24 includes specific provisions for openings in breakaway walls.

Solid perimeter foundation walls on which manufactured homes are installed

Manufactured homes may be installed on solid perimeter foundation walls that enclose space below the homes (see Figure 6). Even if it is not part of the load-bearing foundation, a solid perimeter wall is required to have openings, otherwise hydrostatic loads may damage the perimeter wall, which could, in turn, damage the home's supporting foundation and anchor system.

Openings are required in rigid skirting that is attached to frames or foundations of manufactured homes to relieve hydrostatic loads and minimize transferring loads that can damage homes and their supporting foundation systems.

Figure 7 shows an example of a framed enclosure below an elevated manufactured home. In this case, the full-height enclosed

area is used for parking and storage. Openings are required because the walls surrounding the enclosed area are solid walls. As indicated by the driveway on the left, the interior slab is higher than the exterior grade along the side of the building. The openings shall be located within 1 foot of the interior grade.

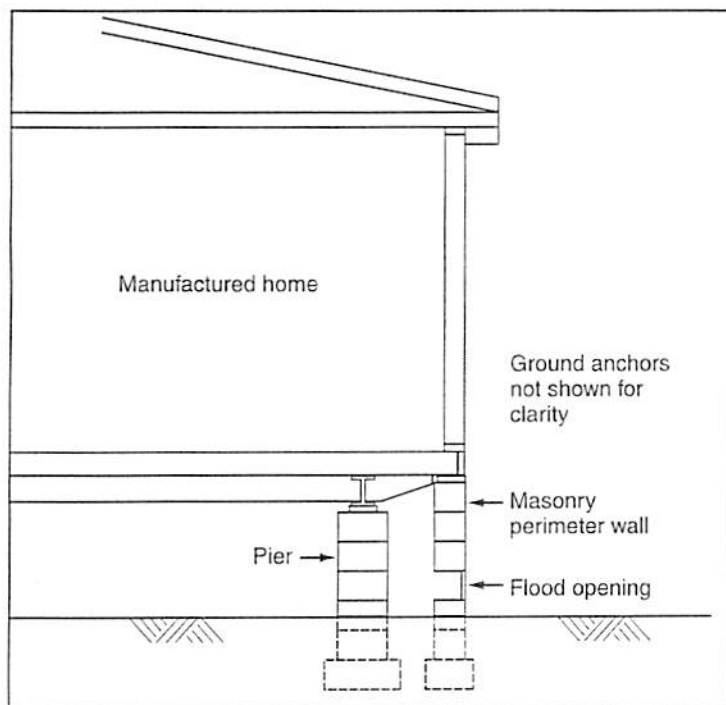

Figure 6. Manufactured home supported on piers; masonry perimeter wall with flood openings (ground anchors not shown)

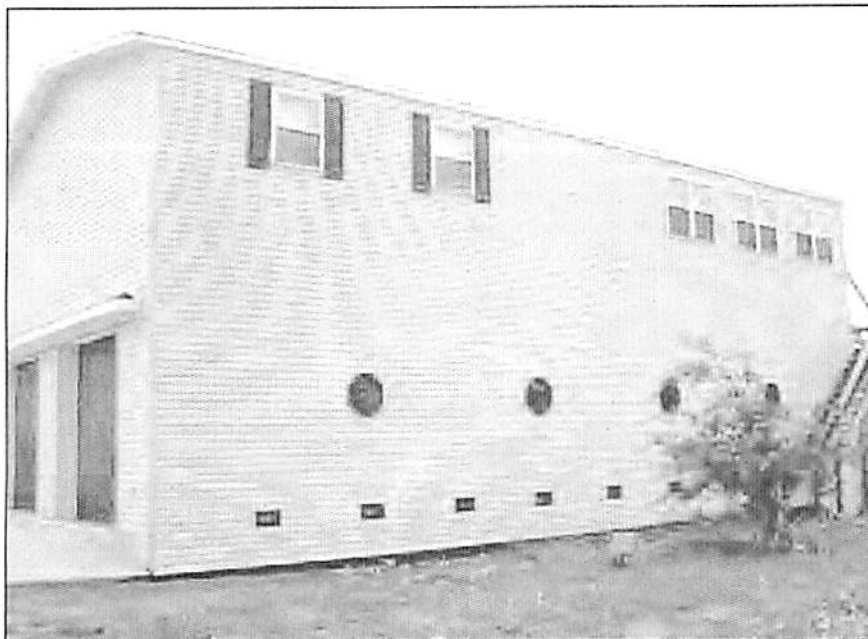

Figure 7. Manufactured home installed above a full-height framed garage (note elevation of driveway slab on left; the openings are within 1 foot of interior grade of the slab)

Accessory structures: detached garages and storage sheds

Detached garages and detached storage buildings in A zones may be permitted without requiring them to be elevated if they comply with all of the requirements for enclosures. Garages and other accessory buildings must be used only for parking of vehicles and storage, utilities must be elevated, flood damage-resistant materials must be used below the BFE, the requirements for flood openings must be satisfied, and they must be anchored to resist flotation, collapse, or lateral movement under flood conditions.

Communities are required to regulate all development in SFHAs, including the placement of small storage sheds. Storage sheds in A zones are not required to be elevated if they comply with all of the requirements for enclosures. They must be used only for storage, utilities must be elevated, flood damage-resistant materials must be used below the BFE, and the requirements for flood openings must be satisfied. In addition, sheds are to be anchored to prevent flotation, collapse, or lateral movement under flood conditions.

Situations That Do Not Require Openings

Two situations that do not require openings are described below:

- Manufactured home with skirting
- Back-filled stem wall foundation

Manufactured home with flexible skirting

Skirting used to enclose the area under manufactured homes typically is made of weather-resistant material and extends from the bottom of the home down to grade. Flexible skirting and rigid skirting that are not attached to the frame or foundation of a manufactured home are not required to have openings. However, where floodwaters are expected to rise rapidly, there may be concerns about the skirting being pushed against foundation systems. In these areas, open lattice may be more appropriate to minimize the potential for flood damage.

Filled stem wall foundation

A filled stem wall foundation (also called a chain wall) can look like a solid perimeter foundation wall from the outside, but this type of foundation is backfilled with compacted structural fill that supports the floor slab (see Figure 8). Because of the fill, unbalanced lateral loads against the walls will be minimized as floodwaters, and thus openings are not required.

The National Fire Protection Association's standard, *Model Manufactured Home Installation Standard* (NFPA 225), specifies that installation of skirting does not trigger the requirement for flood openings provided the skirting does not provide structural support and will collapse under wind and water loads that are less than those expected during the base flood event without causing structural damage to the elevated home or the foundation.

It is important that the final Elevation Certificate, or other documentation of elevations, include an explanation when stem wall foundations are used to avoid the assumption that it is a crawlspace that lacks the required openings. The Elevation Certificate diagrams do not illustrate filled stem wall foundations. A note in the comment section should describe the foundation so that insurance agents are alerted as to why there are no openings.

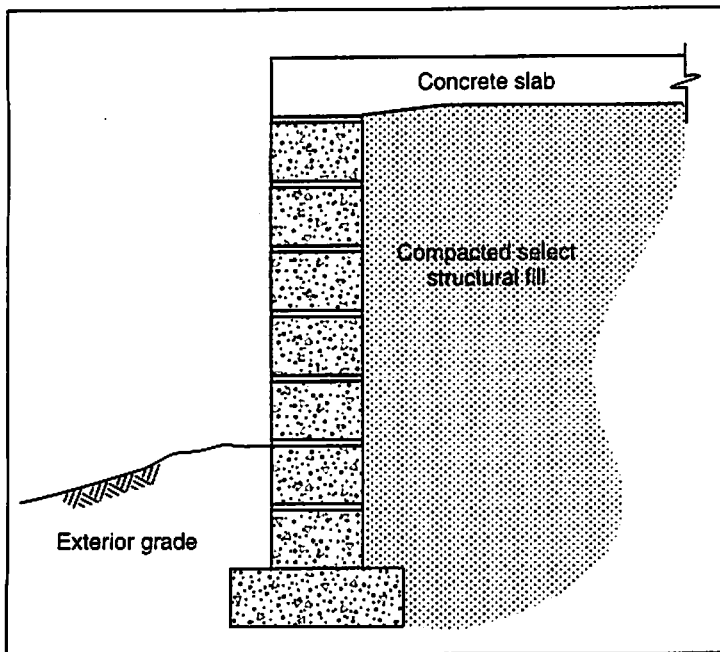

Figure 8. Back-filled stem wall foundation (openings not required)

Requirements and Guidance for Installation of Openings

The NFIP regulations specify certain installation requirements that must be met by all flood openings, whether non-engineered openings or engineered openings, which are described starting on page 18. The installation requirements address the minimum number of openings and the maximum height of openings above grade. Additional guidance and explanations for various situations are described below.

Minimum Number of Openings

Each enclosed area is required to have a minimum of two openings on exterior walls to allow floodwaters to enter directly. In order to meet the requirement, the openings must be located so that the portion of the opening intended to allow for inflow and outflow is below the BFE. Openings that are entirely above the BFE (or any portion of an opening that is above the BFE) will not serve the intended purpose during base flood conditions and thus are not counted towards the compliance with the flood opening requirements.

The openings should be installed on at least two sides of each enclosed area to decrease the chances that all openings could be blocked with floating debris and to allow for more even filling by floodwater and draining of the enclosed area. It is recommended that openings be reasonably distributed around the perimeter of the enclosed area unless there is clear justification for putting all openings on just one or two sides (such as in townhouses or buildings set into sloping sites).

The International Residential Code® and the International Building Code® (by reference to ASCE 24) both require a "minimum of two openings on different sides of each enclosed area."

Figure 9 shows a sketch illustrating where openings could be located when an elevated building has multiple enclosed areas. [Note: the number of openings shown in Figure 9 is for illustration only; the total number of openings and the adequacy of the net open area of those openings depend on the type of opening, covering, and whether vent devices or engineered openings are installed.]

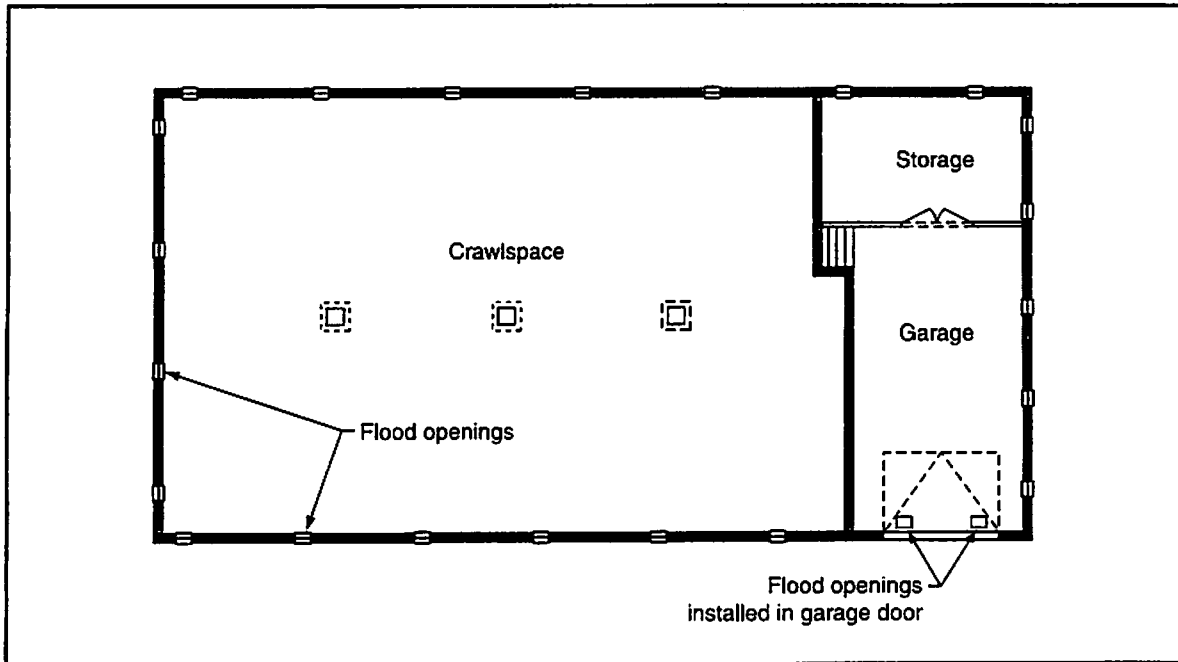

Figure 9. Sketch of foundation plan of home with multiple enclosed areas, each with flood openings (number of openings for illustration purposes only)

Height of Openings Above Grade

The bottom of each opening is to be located no higher than 1 foot above the grade that is immediately under each opening. The purpose of this requirement is to satisfy the performance expectation that the difference in water levels between the interior and exterior will not exceed 1 foot as water begins to rise and as floodwaters recede from the site. Note that the openings (or those portions that count towards the required net open area) must be located below the BFE. In areas with shallow flood depths, this may require positioning the openings closer to grade than the maximum 1 foot allowed.

Given the requirement that the bottom of openings shall not be higher than 1 foot above grade, a question arises if the interior and exterior grades are different: which grade should be used to determine placement of flood openings? The higher of the final interior grade and the finished exterior grade that is immediately under each opening is used to make this determination:

- **Finished exterior grade.** Care should be taken when placing backfill, topsoil, and landscaping materials around the outside of enclosures, especially solid perimeter foundation

walls. If the finished exterior grade is higher than the interior grade on all sides of the building, then the enclosed area becomes a basement as defined by NFIP.

- **Final interior grade.** The trench that is excavated to construct footings and foundation walls must be backfilled completely, otherwise a basement is created. If the interior grade is higher than the exterior grade, the openings are to be no higher than 1-foot above the interior grade.

Installation Examples

Interior grade higher than exterior grade

Consider a crawlspace enclosure that has its interior grade higher than the exterior grade. As water rises against the outside of the foundation, the ground or fill on the interior balances the hydrostatic load (see Figure 10). It is only when the water rises above the interior grade that the lateral load becomes unbalanced and therefore must be equalized by openings.

When viewed from the outside, a solid perimeter foundation wall or wall surrounding an enclosed area with the interior grade higher than the exterior grade will appear to not meet the installation requirements for openings. The openings will appear to be too high above the exterior grade (illustrated in Figure 7). Therefore, it is important that the final documentation of as-built elevations note the difference in interior and exterior grades. For example, if the NFIP Elevation Certificate is used, comments should explain that the interior grade is higher than the exterior grade and it should be noted whether the openings are (or are not) within 1 foot of the higher of the two grades.

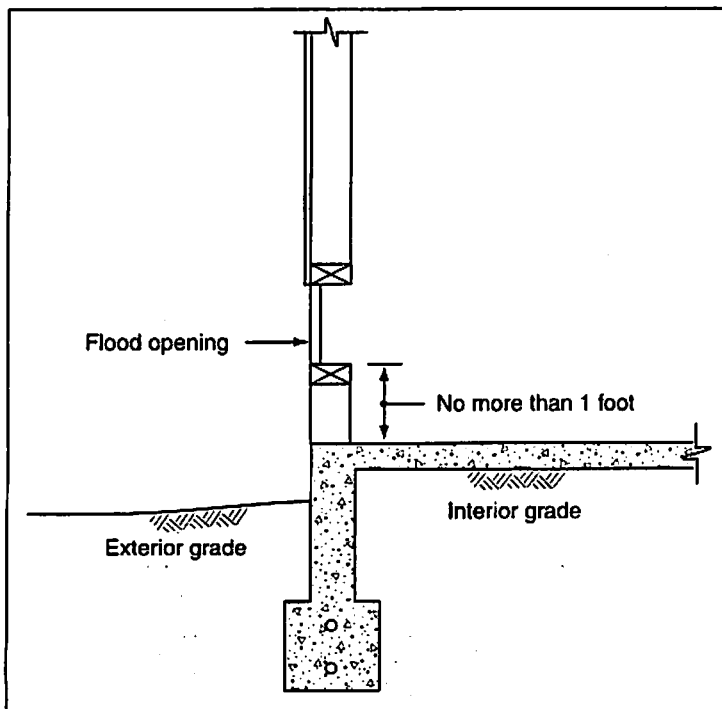

Figure 10. Illustration of flood openings installed within 1 foot of the higher of interior or exterior grade

Sloping sites

Buildings on solid perimeter foundation walls that are set into a sloping site present another special situation with respect to installation of openings. Careful attention must be paid to the following:

- The interior floor along the lower side of a building that is set into a sloping site must be at or above the exterior grade across the entire length of that side of the building, otherwise the enclosure becomes a basement.
- The bottom of each opening shall be located no higher than 1 foot above the exterior or interior grade immediately below the opening, whichever is higher (see Figure 11).
- For openings to perform their intended function, sufficient open area must be below the BFE.

Figure 11. Openings in enclosure walls, sloping site

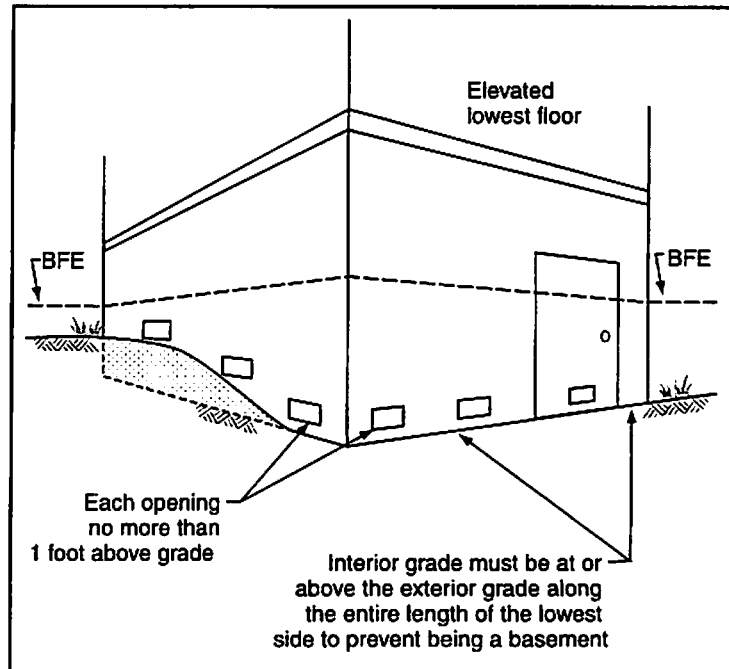

Townhouses with limited exterior walls

Townhouses are single-family dwelling units constructed in a group of three or more attached units in which each unit extends from foundation to roof and with exterior walls on at least two sides. Openings are required if townhouses in SFHAs are constructed with solid perimeter foundation walls or with solid walls surrounding enclosed areas under the elevated portion of the building.

Because the interior townhouse units have less linear exterior wall length than the end units, it can be a challenge to meet all of the requirements, especially the requirement for adequate net open area and the requirement that each enclosed area have openings. If openings cannot be provided in at least two walls, the NFIP allows all openings to be installed in one wall.

Design of interior townhouse units can satisfy the guidance that openings should be on different sides if the walls inside the enclosed area have openings to connect enclosed spaces from front to back. Figure 12 shows suggested locations for openings. [Note: the number of openings shown in Figure 12 is for illustration only; the total number of openings and the adequacy of the net open area depend on the type of opening, covering, and whether a vent device is installed in the openings.]

It may be even more challenging to provide adequate openings in enclosures under interior townhouse units if the multi-unit building is set into a sloping site, in which case it may be appropriate to consider using a filled stem wall foundation or an open foundation. Use of fill across one side of elevated townhouses may create a similar complication.

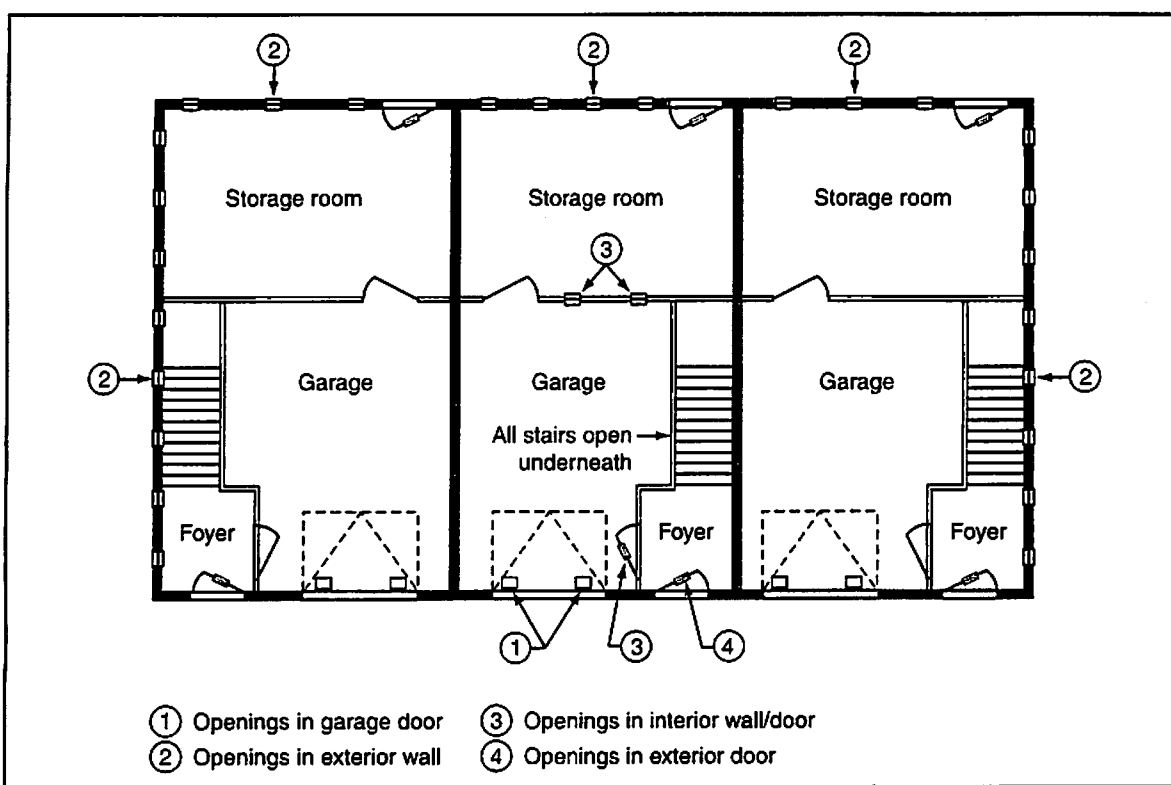
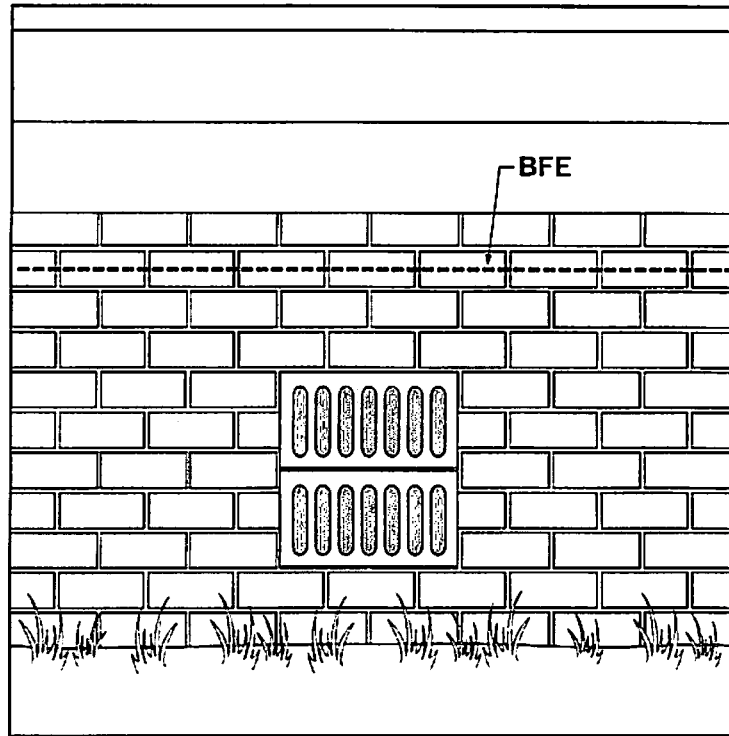

Figure 12. Illustration of suggested flood openings in enclosures under elevated townhouses (number of openings for illustration purposes only)

Openings that extend above the BFE

Only those portions of openings that are below the BFE can be counted towards the required net open area. Stacked vent devices may be installed or large-dimension openings may be provided (Figure 13). In both cases, if the BFE does not reach the top of the opening, only the portion that is below the BFE will count as contributing to the required net open area. Similarly, if the floor of a mechanical room is below the BFE (with elevated equipment inside) and a louvered door provides ventilation, only the open portion of the louvered door that is below the BFE will count towards the required net area of flood openings.

Figure 13. Stacked vents inserted in large openings must be below the BFE



Depth of water 1 foot or less

Some FIRMs show mapped SFHAs where the depth of water will be 1-foot deep or shallower. Although the difference in water depth between the outside and inside of the enclosure under a building in these areas will not exceed 1 foot during the base flood, the NFIP regulations require openings.

There are at least two solutions to this situation. The first is to elevate the floor of the enclosure the necessary height so that it is at or above the BFE and there is no need for openings. The second solution is to install openings, taking care to ensure that all of the necessary open area is below the BFE (otherwise the openings will not function as intended). This can be accomplished by positioning the bottom of the openings at or very close to grade, rather than the maximum of 1 foot above grade. In addition to complying with the regulations, the walls will not experience excessive differential hydrostatic pressure when floodwaters rise higher than the BFE.

Non-Engineered Openings and Engineered Openings

The NFIP regulations identify alternatives to provide sufficient size and number of openings to allow for the automatic entry and exit of floodwaters. This section describes how this level of performance can be satisfied by use of:

- Non-engineered openings (or covers and devices) that meet the prescriptive requirement to provide 1 square inch of net open area for each square foot of enclosed area (as

described below, a variety of options and devices can serve as non-engineered openings).

- Engineered openings (or covers and devices) that are specifically designed and certified by a registered design professional as meeting the required performance and design requirements outlined below (and, if applicable, the community's building code).
- Engineered openings (or covers and devices) for which an Evaluation Report has been issued by the International Code Council (ICC) Evaluation Service, Inc. (ICC-ES), a subsidiary of the International Code Council, Inc. (<http://www.iccsafe.org>).

The International Residential Code® includes both the prescriptive (non-engineered) alternative and the engineered openings alternative.

The International Building Code® also includes both alternatives by reference to ASCE 24.

The following requirements for installation apply regardless of whether engineered openings or non-engineered openings are used to satisfy the NFIP requirements (also see page 13, Requirements and Guidance for Installation of Openings):

- Each enclosed area must have a minimum of two openings; if there are multiple enclosed areas, each area must have openings in its exterior walls.
- The bottom of each opening must be no more than 1 foot above the higher of the interior or exterior grade immediately under the opening, and
- Any screens, grates, grilles, fixed louvers, or other covers or devices must not block or impede the automatic flow of floodwaters into and out of the enclosed area.

Unacceptable Measures

It is important to note that FEMA has determined that certain measures are not acceptable as flood openings, including:

- Standard foundation air ventilation devices that can be closed manually, because they do not allow for the automatic entry and exit of floodwaters unless they are permanently disabled in the open position.
- Standard foundation air ventilation devices that have detachable solid covers that are intended to be manually installed over the opening in cold weather, because they do not allow for the automatic entry and exit of floodwaters when the cover is in place.
- Standard foundation air ventilation devices that are designed to open and close based on temperature (unless they also are designed to allow for the automatic entry and exit of floodwaters).
- Windows below the BFE, because the automatic entry and exit of floodwaters cannot be satisfied by the expectation that windows will break under rising floodwaters.
- Garage doors without openings installed in them, because human intervention is required to open the doors when flooding is expected. Gaps between the garage door and the door jamb or walls do not count towards the net open area requirement.
- Standard exterior doors without openings installed in them.

Non-Engineered Openings

Non-engineered openings are openings that are used to satisfy the prescriptive requirement that calls for 1 square inch of net open area for each square foot of enclosed area. A wide variety of options is available to satisfy the prescriptive requirements.

The term “net open area” refers to the permanently open area of a non-engineered opening. The NFIP regulations indicate that flood openings may be equipped with coverings or devices provided that they permit the automatic entry and exit of floodwaters. The measurement of the net open area must take into consideration any coverings that have solid obstructions, such as grilles, fixed louvers, or faceplates. Figure 14 shows a typical standard air vent faceplate and measurements of the net open area.

Figure 14. Typical standard air vent faceplate (this example provides 42 square inches of net open area)

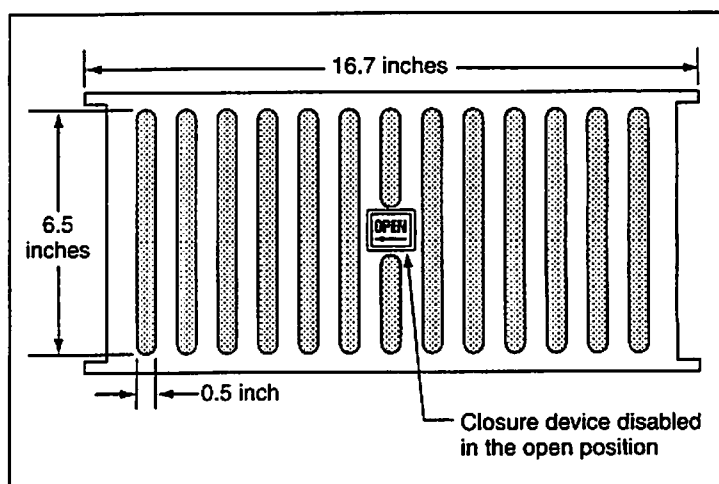

Manufacturers of devices intended for use as standard air vents typically indicate the number of square inches that each device provides for air flow (either stamped into the metal frame or noted on the packaging). The same number should be used for the net open area calculation when these devices are installed as non-engineered openings. However, in order to qualify as flood openings that permit automatic entry and exit of floodwaters, openings must not have solid covers that are installed during cold weather. Similarly, typical air vent devices that are designed to be opened and closed manually must be disabled permanently in the open position.

Insect screens that do not impede the entry and exit of floodwaters are allowed and do not affect the determination of the net open area. Communities that administer the *International Building Code*® (IBC®) or the *International Residential Code*® (IRC®) should note the requirement to cover ventilation openings to keep animals and insects from entering. These codes provide a list of acceptable covering materials. The commentaries that accompany those codes note that some covering materials may reduce the gross open area of the vent by as much as 50 percent. In areas where floodwaters are expected to carry debris such as grass clippings and leaves, it is notable that screens tend to clog (Figure 15). Local officials may determine that additional openings are required to increase the likelihood that openings will perform as expected, even if some become clogged with debris.



Figure 15. Typical air vent clogged by flood debris

Examples of several commonly used non-engineered openings are described below and shown in Figures 16 through 21:

- Figures 16 and 17 show typical standard air ventilation devices that are intended for installation in crawlspace foundation walls. If installed as flood openings, they must be disabled permanently in the open position to satisfy the requirement for automatic entry and exit of floodwaters (note that the device shown in Figure 17 is not compliant because it is not disabled in the open position).
- Figure 18 shows two examples where the builder provided decorative treatment for open holes; in each case, only the net open area is counted, and the area covered by the decorative treatment is not counted.
- Figure 19 shows a common practice for solid perimeter foundation walls constructed of standard 16" x 8" concrete masonry blocks. If a block is omitted as shown, the resulting void provides 128 square inches of net open area.
- Figure 20 shows where standard blocks are turned sideways. The voids in the blocks are measured to determine the net open area.
- Figure 21 shows a foundation in which a hole was created when the concrete was poured; a wood frame covered with screening is inserted in the hole. The framed void is measured to determine the net open area.

The IRC and IBC (through reference to ASCE 24) require that flood openings are to be not less than 3 inches in any direction in the plane of the wall. This requirement applies to the hole in the wall, excluding any device that may be inserted such as typical foundation air vent device.

Communities usually require screens over voids (open holes) that are created in walls to serve as flood openings, to limit the entry of insects and rodents provided the screens do not impede the inflow and outflow of floodwaters.

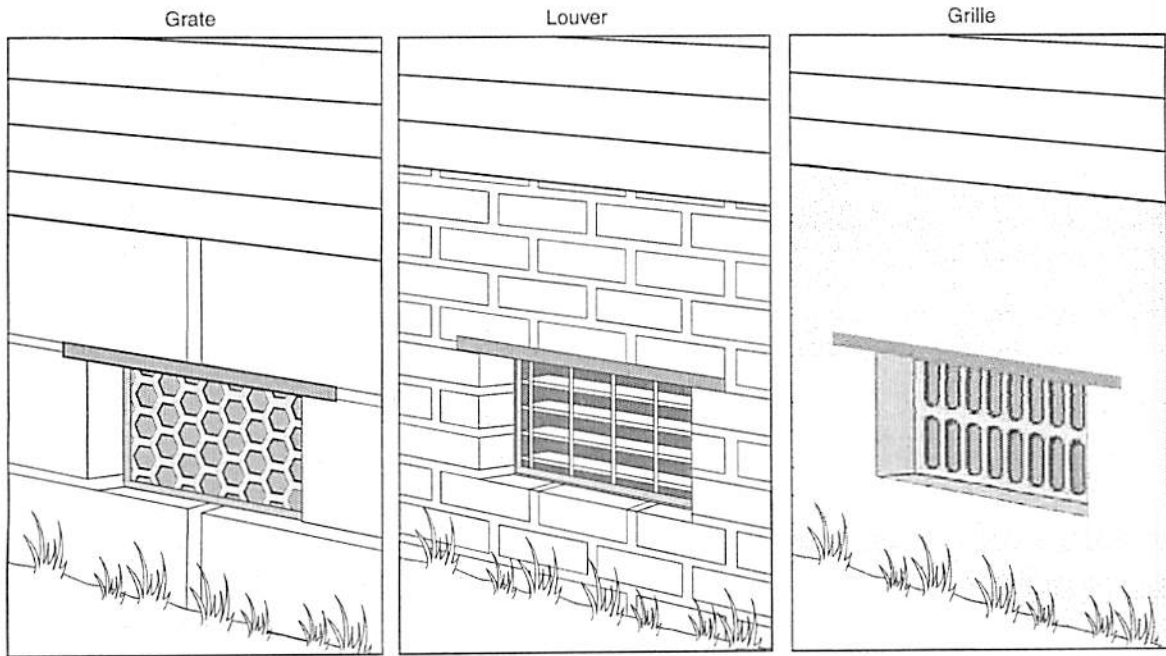

Figure 16. Examples of typical air vents used as flood openings (net open area varies)

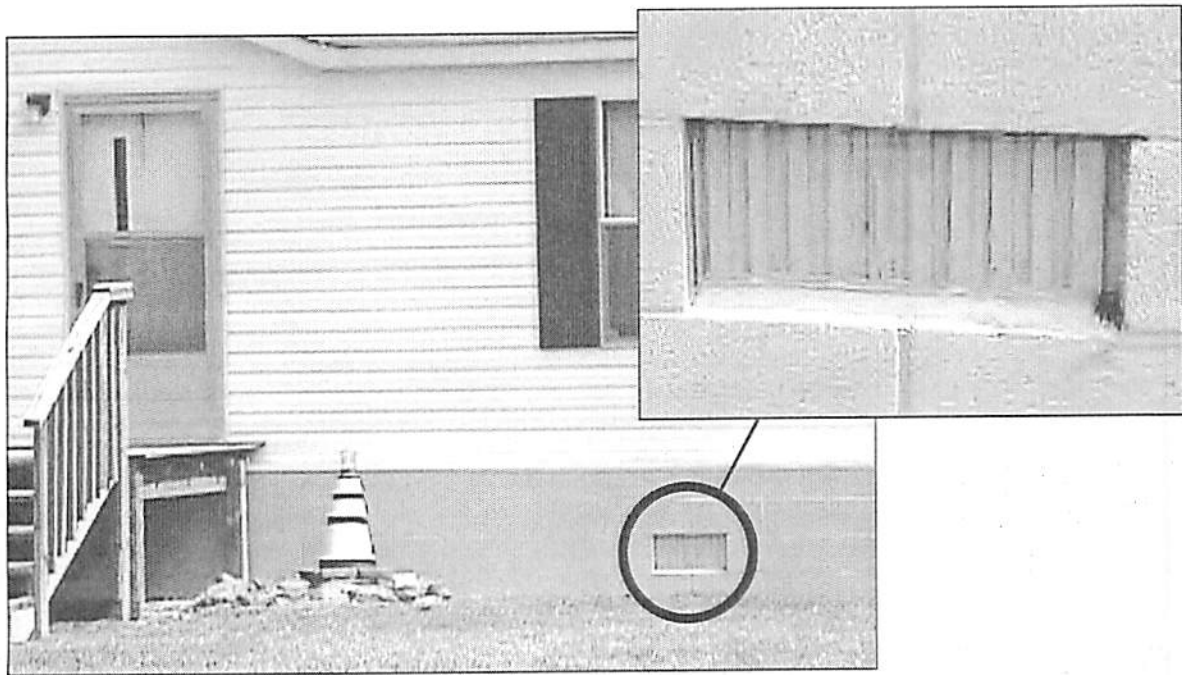

Figure 17. Although this standard air vent was intended as flood openings, it is not acceptable because it is not disabled in the open position and does not allow automatic inflow and outflow of floodwaters.

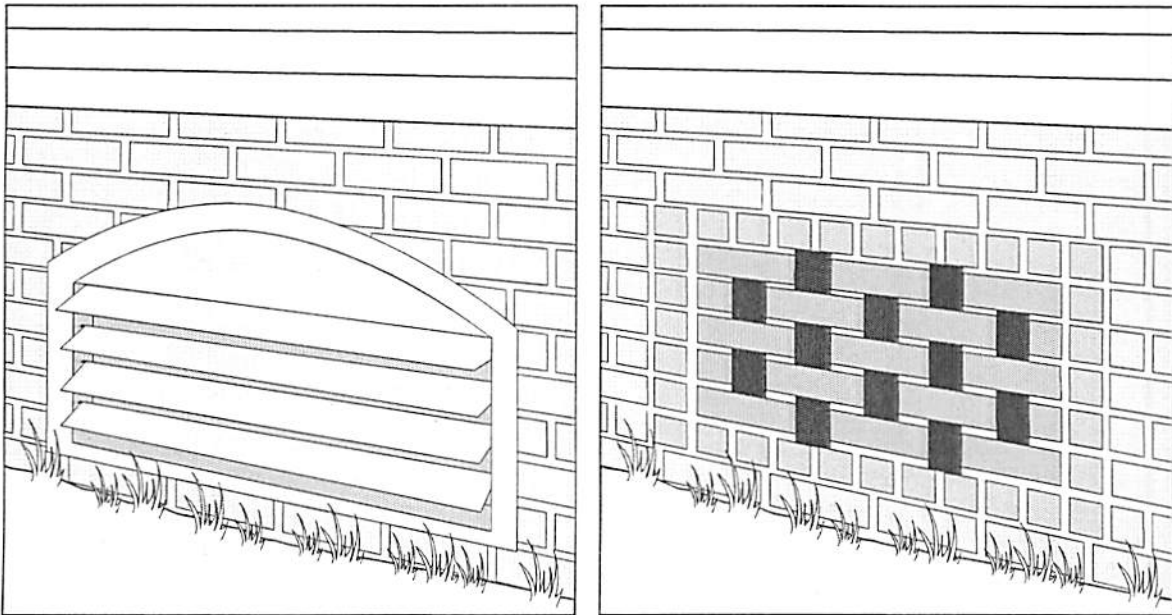

Figure 18. Decorative treatments using fixed louvers and brickwork (count the "net open area" or have certified as engineered openings)

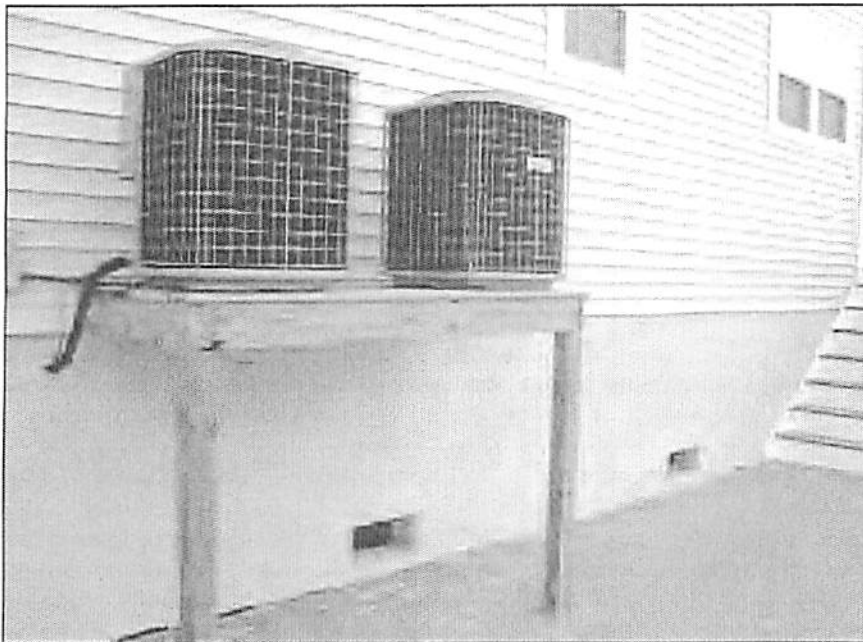

Figure 19. Foundation wall with omitted blocks as flood openings (insect screen not visible)

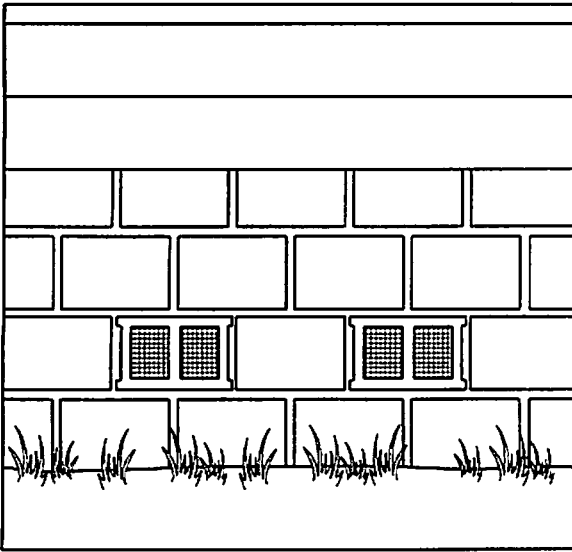

Figure 20. Concrete block turned sideways (insect screening shown)

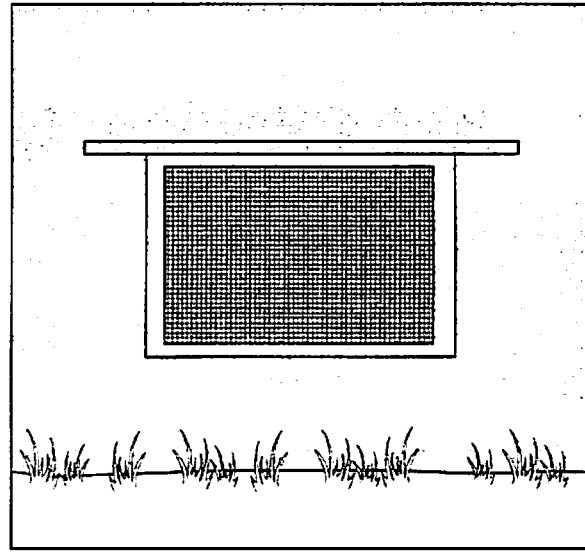

Figure 21. Wood frame with insect screen inserted in opening in poured concrete foundation wall

Engineered Openings

Openings that are designed and certified by a registered design professional as meeting the performance required by the regulations are called “engineered openings.” This section describes certification and documentation requirements for engineered openings and the specific design requirements.

Engineered openings with individual certification

For architectural or other reasons, building designers or owners may prefer to use unique or individually designed openings or devices. In these cases, a registered design professional must submit a certification. As a general rule, States require a designer to be licensed to practice in the State in which building is located.

The original certification of the engineered openings must include the design professional’s name, title, address, signature, type of license, license number, the State in which the license was issued, and the signature and applied seal of the certifying registered design professional. The certification shall identify the building in which the engineered openings will be installed. The language of the certification shall address the following:

- A statement certifying that the openings are designed to automatically equalize hydrostatic flood loads on exterior walls by allowing the automatic entry and exit of floodwaters in accordance with the Engineered openings, design requirements on page 26.
- Description of the range of flood characteristics tested or computed for which the certification is valid, such as rates of rise and fall of floodwaters, and
- Description of the installation requirements or limitations that, if not followed, will void the certification.

Engineered openings with ICC-ES Evaluation Reports

Engineered openings or devices may be accepted by local officials as an alternative to non-engineered openings (prescriptive) provided the designs are certified. The certification may take the form of the individual certification described above, or it can be an Evaluation Report issued by the ICC-ES. The ICC-ES issues such reports for a variety of building products, methods, and materials. Evaluation Reports are issued only after the ICC-ES performs technical evaluations of documentation submitted by a manufacturer, including technical design reports, certifications, and testing that demonstrate code compliance and performance.

ICC-ES has issued *Acceptance Criteria for Automatic Foundation Flood Vents (AC364)* for one type of engineered opening. The ICC-ES will develop acceptance criteria for other types, upon request.

Evaluation Reports are supported by certifications that include appropriate language describing performance of the openings and the name, title, address, type of license, license number, the State in which the license was issued, and the signature and seal of the certifying registered design professional. The specific provisions that are addressed in the certification must include:

Local officials in communities that do not administer the International Code Series determine whether to accept building products that have received Evaluation Reports issued by the ICC-ES.

- A statement certifying that the openings are designed to automatically equalize hydrostatic flood loads on exterior walls by allowing the automatic entry and exit of floodwaters in accordance with the Engineered openings, design requirements below,
- Description of the range of flood characteristics tested or computed for which the certification is valid, such as rates of rise and fall of floodwaters, and
- Description of the installation requirements or limitations that, if not followed, will void the certification.

Documentation of engineered openings for compliance

An important part of the evidence necessary to document compliance is the certification of engineered openings or the Evaluation Report. A copy of the individual certification or the Evaluation Report is required to be kept in the community's permanent permit files, along with inspection reports. The documentation can be submitted as part of the permit application and design drawings, or submitted separately. Owners should retain the certification or a copy of the Evaluation Report to submit along with applications for NFIP flood insurance.

Documentation of engineered openings for flood insurance

Insurance agents will request that property owners provide documentation as part of applications for NFIP flood insurance. The documentation should be attached to the Elevation Certificate. The following are acceptable forms of documentation:

- For engineered openings with individual certification, the certification described above that is signed and sealed by a registered design professional who is licensed in the State where the building in which the engineered openings are used is located; or

- For engineered openings with ICC-ES Evaluation Reports, a copy of the Evaluation Report that documents that the engineered openings meet the performance requirements of the NFIP and the building code, and that specifies the number of such openings that are required for a specified square footage of enclosed area below the BFE; or
- For engineered openings with ICC-ES Evaluation Reports, a letter or other written evidence from the local official that use of engineered openings in a specific building is acceptable.

Engineered openings, design requirements

The American Society of Civil Engineers (ASCE) developed the standard *Flood Resistant Design and Construction* (ASCE 24). This standard applies to buildings and site developments proposed in flood hazard areas; it is referenced by the *International Building Code*. ASCE 24 Section 2.6.2.2 contains installation and design criteria for engineered openings. ASCE 24 provides the equation below to determine the total net area of engineered openings that are installed in foundation walls or enclosure walls. The equation includes a coefficient that corresponds to a factor of safety of 5, which is consistent with design practices related to protection of life and property. This factor of safety also helps to account for the likelihood that insect screens may clog with flood-borne debris. The ASCE 24 commentary provides additional background on the derivation of the equation.

As with non-engineered openings, engineered openings must be designed to allow automatic entry and exit of floodwaters.

Three design and performance criteria for engineered openings are specified in ASCE 24 but are not explicitly identified in the NFIP regulations:

- Engineered openings are to perform such that difference between the exterior and interior water levels shall not exceed 1 foot during base flood conditions.
- Engineered openings are to be not less than 3 inches in any direction in the plane of the wall. This requirement applies to the hole in the wall, excluding any screen, grate, grille, louvers, or devices that may be placed in or over the opening.
- In the absence of reliable data on the rates of rise and fall, engineered openings are to be designed based on the assumption that the minimum rate of rise and fall will be 5 feet per hour. Where data or analyses indicate more rapid rates of rise and fall, the required number of openings is to be increased to account for those different conditions. The number or size of the openings may be decreased if data or analyses indicate rates of rise and fall are less than 5 feet per hour.

From ASCE 24, the equation to determine area of engineered openings:

$$A_o = 0.033 [1/c] R A_e$$

Where: A_o = total net area of openings required (in²)

0.033 = coefficient corresponding to a factor of safety of 5.0 (in² • hr/ft³)

c = opening coefficient (non-dimensional; see ASCE 24, Table 2-2)

R = worst case rate of rise and fall (ft/hr)

A_e = total enclosed area (ft²)

[ASCE 24] Table 2-2

Flood Opening Coefficient of Discharge

Opening Shape and Condition	c
circular, unobstructed during design flood	0.60
rectangular, long axis horizontal, short axis vertical, unobstructed during design flood	0.40 ^a
square, unobstructed during design flood	0.35
rectangular, short axis horizontal, long axis vertical, unobstructed during design flood	0.25 ^b
other shapes, unobstructed during design flood	0.30

Notes:

- a. When the horizontal dimension is twice or more the vertical dimension, use 0.4; as the dimensions approach a square, interpolate from 0.4 to 0.35.
- b. When the horizontal dimension is half or less the vertical dimension, use 0.25; as the dimensions approach a square, interpolate from 0.25 to 0.35.

Used with permission from ASCE.

The NFIP

The U.S. Congress established the NFIP with the passage of the National Flood Insurance Act of 1968. The NFIP is a Federal program enabling property owners in participating communities to purchase insurance as protection against flood losses, in exchange for State and community floodplain management regulations that reduce future flood damages. Participation in the NFIP is based on an agreement between communities and the Federal Government. If a community adopts and enforces adequate floodplain management regulations, FEMA will make flood insurance available within the community.

Title 44 of the U.S Code of Federal Regulations contains the NFIP criteria for floodplain management, including design and construction standards for new and substantially improved buildings located in SFHAs identified on the NFIP's Flood Insurance Rate Maps. FEMA encourages communities to adopt floodplain management regulations that exceed the NFIP criteria. As an insurance alternative to disaster assistance, the NFIP reduces the escalating costs of repairing damage to buildings and their contents caused by floods.

NFIP Technical Bulletins

This is one of a series of Technical Bulletins that FEMA has produced to provide guidance concerning the building performance requirements of the NFIP. These requirements are contained in Title 44 of the U.S. Code of Federal Regulations at Section 60.3. The bulletins are intended for use by State and local officials responsible for interpreting and enforcing the requirements in their floodplain management regulations and building codes, and by members of the development community, such as design professionals and builders. New bulletins, as well as updates of existing bulletins, are issued periodically, as necessary. The bulletins do not create regulations; rather, they provide specific guidance for complying with the requirements of existing NFIP regulations. Users of the Technical Bulletins who need additional guidance should contact their NFIP State Coordinator or the appropriate FEMA regional office. The *User's Guide to Technical Bulletins* (<http://www.fema.gov/pdf/final/guide01.pdf>) lists the bulletins issued to date.

Ordering Technical Bulletins

The quickest and easiest way to acquire copies of FEMA's Technical Bulletins is to download them from the FEMA website (<http://www.fema.gov/plan/prevent/floodplain/techbul.shtm>).

Technical Bulletins also may be ordered free of charge from the FEMA Publications Warehouse by calling 1-800-480-2520, or by faxing a request to 301-362-5355, Monday through Friday between 8 a.m. and 5 p.m. EST. Please provide the FEMA publication number, title, and quantity of each publication requested, along with your name, address, zip code, and daytime telephone number. Written requests may also be submitted by mail to the following address:

FEMA Publications
P.O. Box 2012
Jessup, MD 20794

Further Information

The following sources provide further information concerning openings in foundation walls and walls of enclosures.

American Society of Civil Engineers, Structural Engineering Institute. 2005. *Flood Resistant Design and Construction*, ASCE/SEI 24-05.

American Society of Civil Engineers, Structural Engineering Institute. 2005. *Minimum Design Loads for Buildings and Other Structures*, ASCE/SEI 7-05.

FEMA. 1991. *Answers to Questions About Substantially Damaged Buildings*, FEMA 213.

FEMA. 2000. *Coastal Construction Manual*, FEMA 55CD (3rd edition).

FEMA. 2004. *Floodplain Management Bulletin: Elevation Certificate*, FEMA 467-1 (<http://www.fema.gov/pdf/fima/fema467-6-10-04.pdf>).

FEMA. 2005. *Home Builder's Guide to Coastal Construction: Technical Fact Sheet Series*, FEMA 499.

FEMA. 2006. *Elevation Certificate* (FEMA Form 81-31, <http://www.fema.gov/pdf/nfip/elvcert.shtm>).

ICC Evaluation Service, Inc. 2007. *Acceptance Criteria for Automatic Foundation Flood Vents* (AC364, http://www.icc-es.org/criteria/pdf_files/ac364.pdf).

International Code Council, Inc. 2006. *International Building Code*[®], IBC[®] 2006.

International Code Council, Inc. 2006. *International Residential Code*[®], IRC[®] 2006.

National Fire Protection Association. 2005. *Model Manufactured Home Installation Standard*[®], NFPA 225.

National Fire Protection Association. 2006. *Building Construction and Safety Code*[®], NFPA 5000.

Glossary

Accessory structure – A structure that is on the same parcel of property as a principal structure, the use of which is incidental to the use of the principal structure.

Base flood – The flood having a 1-percent chance of being equaled or exceeded in any given year, commonly referred to as the “100-year flood.” The base flood is the national standard used by the NFIP and all Federal agencies for the purposes of requiring the purchase of flood insurance and regulating new development.

Base flood elevation (BFE) – The height of the base (1-percent annual chance or 100-year) flood in relation to a specified datum, usually the National Geodetic Vertical Datum of 1929 (NGVD), or the North American Vertical Datum of 1988 (NAVD).

Basement – Any area of a building having its floor subgrade (below ground level) on all sides.

Elevation certificate – A form developed by FEMA to collect surveyed elevations and other information about a building that is necessary to obtain flood insurance.

Enclosure or enclosed area – Areas created by a crawlspace or solid walls that fully enclose areas below the BFE.

Federal Emergency Management Agency (FEMA) – The Federal agency that, in addition to carrying out other activities, administers the National Flood Insurance Program.

Flood Insurance Rate Map (FIRM) – The official map of a community on which FEMA has delineated both the special flood hazard areas (SFHAs) and the risk premium zones applicable to the community.

Hydrodynamic load – The load imposed on an immersed object, such as a foundation element or enclosure wall, by water flowing against and around it. The magnitude of the hydrodynamic load varies as a function of velocity and other factors.

Hydrostatic load – The load imposed on an immersed object such as an enclosure wall, by standing or slowly moving water. The magnitude of the hydrostatic load increases linearly with water depth.

Lowest floor – The lowest floor of the lowest enclosed area of a building, including a basement. Any NFIP-compliant unfinished or flood-resistant enclosure usable solely for parking of vehicles, building access, or storage (in an area other than a basement) is not considered a building’s lowest floor, provided the enclosure does not render the structure in violation of the applicable design requirements of the NFIP.

Mitigation Directorate – The component of FEMA directly responsible for administering the flood hazard identification and floodplain management aspects of the NFIP.

Net open area – The permanently open area of a non-engineered opening intended to provide automatic entry and exit of floodwaters.

Opening, engineered – An engineered opening is an opening that is designed and certified by a registered design professional as meeting certain performance characteristics related to providing automatic entry and exit of floodwaters; the certification requirement may be satisfied by an individual certification or issuance of an Evaluation Report by the ICC Evaluation Service, Inc.

Opening, non-engineered – A non-engineered opening is an opening that is used to meet the NFIP's prescriptive requirement of 1 square inch of net open area for every square foot of enclosed area.

Registered Design Professional – An individual who is registered or licensed to practice their respective design profession as defined by the statutory requirements of the professional registration laws of the State or jurisdiction in which the project is to be constructed.

Special Flood Hazard Area (SFHA) – An area delineated on a FIRM as being subject to inundation by the base flood and designated as Zone A, AE, A1-A30, AR, AO, AH, A99, V, VE, or V1-V30.

Substantial damage – Damage of any origin sustained by a structure whereby the cost of restoring the structure to its before-damaged condition would equal or exceed 50 percent of the market value of the structure before the damage occurred. Structures that are determined to be substantially damaged are considered to be substantial improvements, regardless of the actual repair work performed.

Substantial improvement – Any reconstruction, rehabilitation, addition, or other improvement of a structure, the cost of which equals or exceeds 50 percent of the market value of the structure (or smaller percentage if established by the community) before the "start of construction" of the improvement. This term includes structures that have incurred "substantial damage," regardless of the actual repair work performed.