

PLUMBING PLAN
SCALE: 1/8"=1'

PLUMBING NOTES

1. PROVIDE ALL LABOR, MATERIAL AND EQUIPMENT FOR A COMPLETE OPERATING SYSTEM. THE SYSTEM SHALL INCLUDE HOT AND COLD WATER PIPING, SEWER AND VENT PIPING, INSULATION, WATER HEATER, HANGERS, VALVES, SUPPORTS WITHOUT ANY RESTRICTIONS TO COLUMN. CUT AND PATCH AS REQUIRED TO INSTALL PIPES.
2. ALL WORK AND MATERIAL SHALL CONFORM STRICTLY TO THE LATEST LOCAL, CITY, PARISH, STATE AND NATIONAL GOVERNING CODES.
3. CONTRACTOR IS TO FIELD VERIFY ALL EXISTING UTILITY LOCATIONS, ELEVATIONS AND SIZES PRIOR TO COMMENCING ANY WORK. CONTRACTOR SHALL PAY NECESSARY FEES FOR THE UTILITIES CONNECTIONS.
4. CONTRACTOR IS RESPONSIBLE TO VERIFY THE EXISTING INVERTS AND SET NEW INVERTS OF SEWERAGE AND DRAINAGE PIPES.
5. SEWERAGE LINES 3-INCH AND SMALLER SHALL BE SLOPED 1/4" PER FOOT AND LINE 4-INCH AND LARGER SHALL BE 1/8" PER FOOT.
6. TEST ALL PIPING AT REQUIRED PRESSURE.
7. ALL PLUMBING SHALL BE CLOSELY COORDINATED WITH STRUCTURAL SYSTEM, MECHANICAL SYSTEM AND ELECTRICAL TO INSURE NO TRADES WILL CONFLICT WITH EACH OTHER.
8. DO NOT SCALE DRAWINGS. SEE ARCHITECTURAL DRAWINGS FOR EXACT LOCATIONS OF DOORS, WINDOWS, WALLS, FIXTURES, ETC.
9. ALL WATER MAINS AND PIPING NOT SHOWN FOR CLARITY. ALL LOCATIONS FIELD VERIFIED.
10. DOMESTIC HOT AND COLD WATER PIPING AND FITTINGS UNDER SLAB SHALL BE ASTM B88 COPPER WATER TUBE, TYPE K SOFT ANNEALED. NO JOINTS SHALL BE ALLOWED UNDER THE SLAB.
11. DOMESTIC WATER PIPING AND FITTINGS ABOVE THE SLAB SHALL BE ASTM B88 COPPER WATER TUBE, TYPE L. HARD DRAWN WITH COPPER PRESSURE TYPE FITTINGS, ANSI B16.22. THE JOINTS SHALL BE SOLDERED TYPING USING ASTM B32, ALLOY GRADE 95A (95-5) SOLDER.
12. SOIL, WASTE, VENT PIPING AND FITTINGS ABOVE THE SLAB SHALL BE SERVICE WEIGHT CAST IRON PIPE WITH BELL AND SPIGOT ENDS AND ONE PIECE NEOPRENE INSERT TYPE GASKET. USE PVC SCHEDULE 40 OR ABS DWV PIPES AND FITTINGS WHERE PERMITTED BY CODE.
13. ALL WATER PIPING AND FITTINGS ABOVE THE FLOOR SHALL BE INSULATED WITH 1/2" THICK FIBERGLASS INSULATION AND JACKET.
14. ALL ELECTRICAL MECHANICAL AND PLUMBING PENETRATING FIRE PARTITIONS SHALL BE FIRE CAULKED. (PENETRATIONS THROUGH RATED CONSTRUCTION SHALL BE SEALED WITH A MATERIAL CAPABLE OF PREVENTING THE PASSAGE OF FLAMES AND HOT GASES WHEN TESTED IN ACCORDANCE WITH ASTM-E814.)
15. ALL PLUMBING LINES SHOWN ARE DIAGRAMATIC.

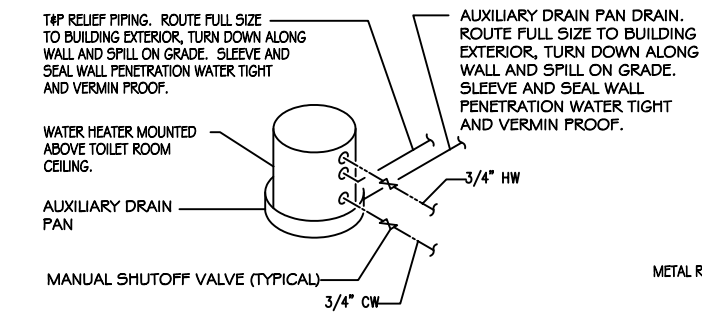

WATER HEATER DETAIL
N.T.S.

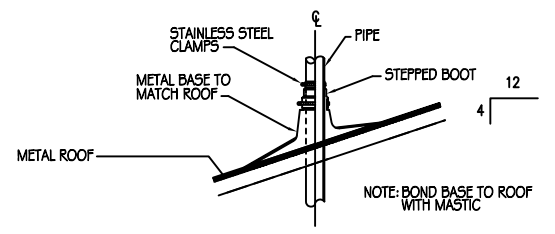

VENT THRU ROOF DETAIL
N.T.S.

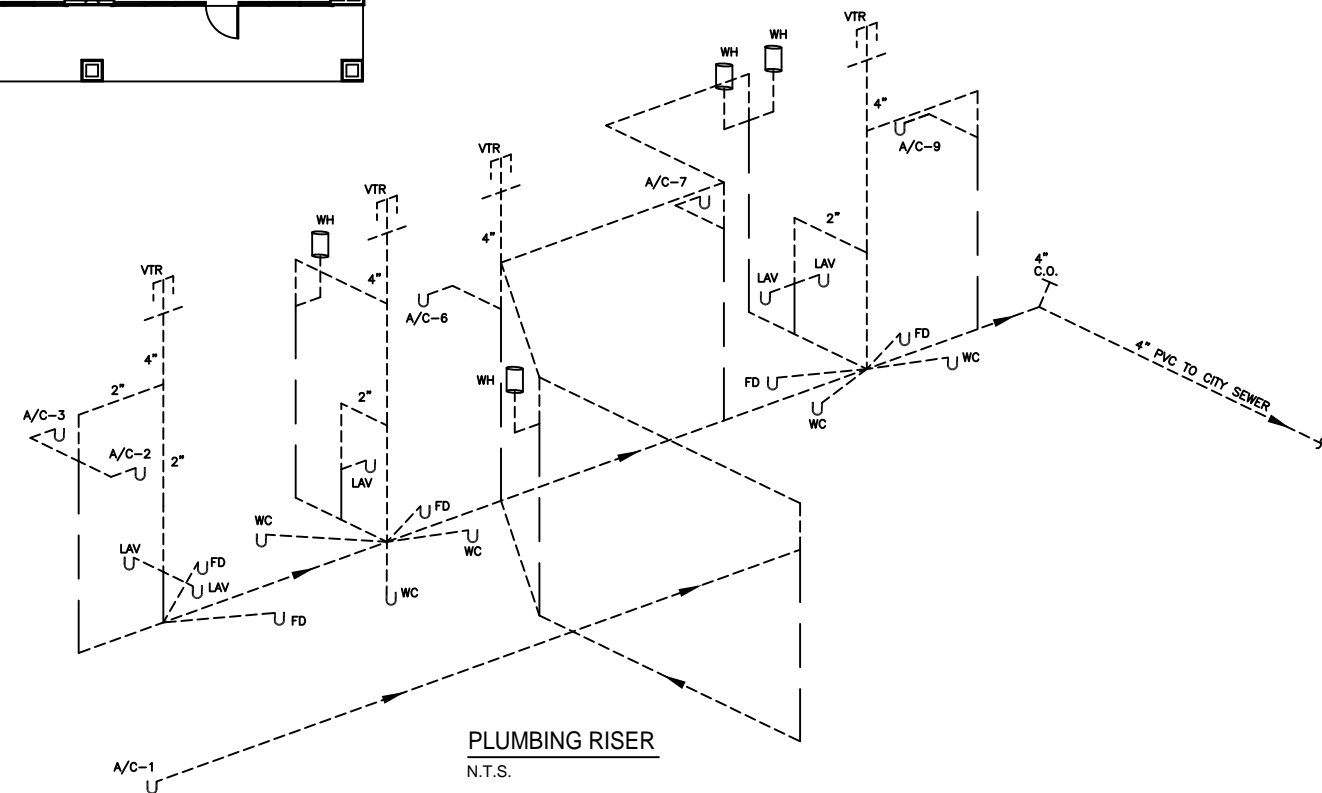

PLUMBING RISER
N.T.S.

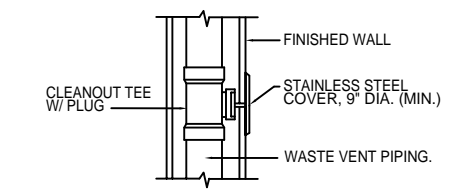

WALL CLEANOUT DETAIL
N.T.S.

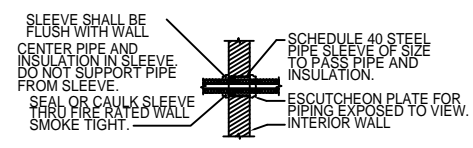

TYPICAL INTERIOR WALL SLEEVE DETAIL
N.T.S.

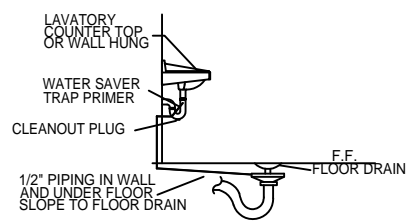

FLOOR DRAIN DETAIL
N.T.S.

PLUMBING FIXTURE SCHEDULE						
MARK	DESCRIPTION	TYPE	ROUGH-IN SIZES			NOTES
			WASTE	VENT	CW	
WC	H.C. WATER CLOSET	VALVE	4"	4"	4"	3
LAV	H.C. LAVATORY	WALL HUNG	2"	2"	1/2"	1, 2, 3
FD	FLOOR DRAIN	-	2"	2"	-	4
WH	WATER HEATER DRAIN	-	-	2"	3/4"	-

- FIXTURE NOTES:
1. INSULATE PIPING FOR HANDICAP FIXTURES.
 2. PROVIDE CHAIR CARRIER FOR WALL HUNG FIXTURES.
 3. H.C. - HANDICAP FIXTURE
 4. INSTALL CONTINUOUS DRIP VALVE ON ALL FLOOR DRAINS.
 5. FIXTURES SELECTED BY OWNER.

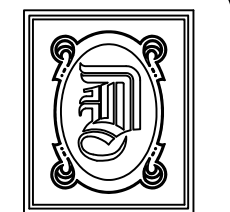

DAMMON ENGINEERING, INC.

CHIEF ENGINEER
EMMETT DAMMON, P.E.

CHIEF ARCHITECT
ROBERT WILTSE

1095 FLORIDA AVENUE
SLIDELL, LA. 70458
OFFICE: 985-649-5832
FAX: 985-641-5950

WEBSITE:
WWW.DAMMONENGINEERING.COM

EMAIL:
DAMMONENG@BELLSOUTH.NET

ARCHITECTURE

ENGINEERING

STUDIES

PLANNING

INVESTIGATION

EXPERT WITNESS

TENANT BUILD-OUT

J D PLAZA
345 GAUSE BOULEVARD
WEST SLIDELL, LA

PLUMBING PLAN

REV:

SCALE: AS NOTED

JOB#: 2070

DATE: 06-25-10

SHEET 10

P-1

OF 10