

16 AIR BARRIER DETAIL - INSIDE/OUTSIDE CORNERS
A5.11 SCALE: N.T.S

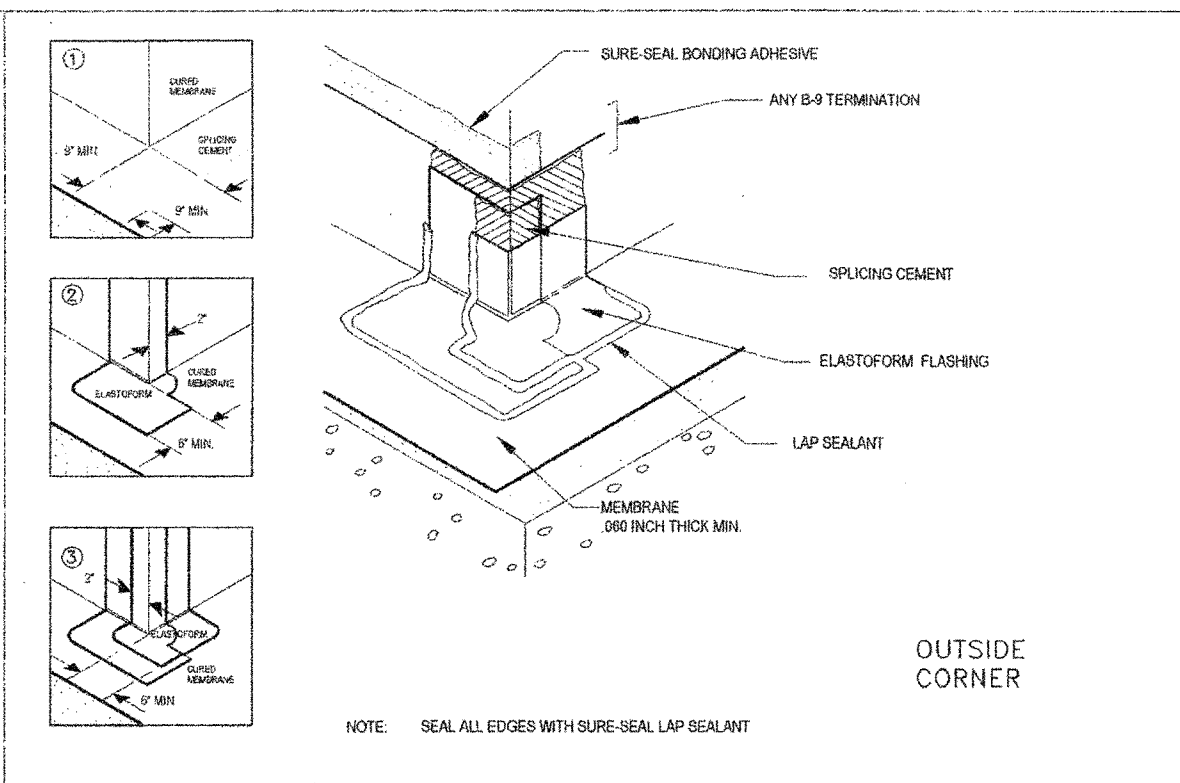

12 AIR BARRIER DETAIL - FIELD CORNER
A5.11 SCALE: N.T.S

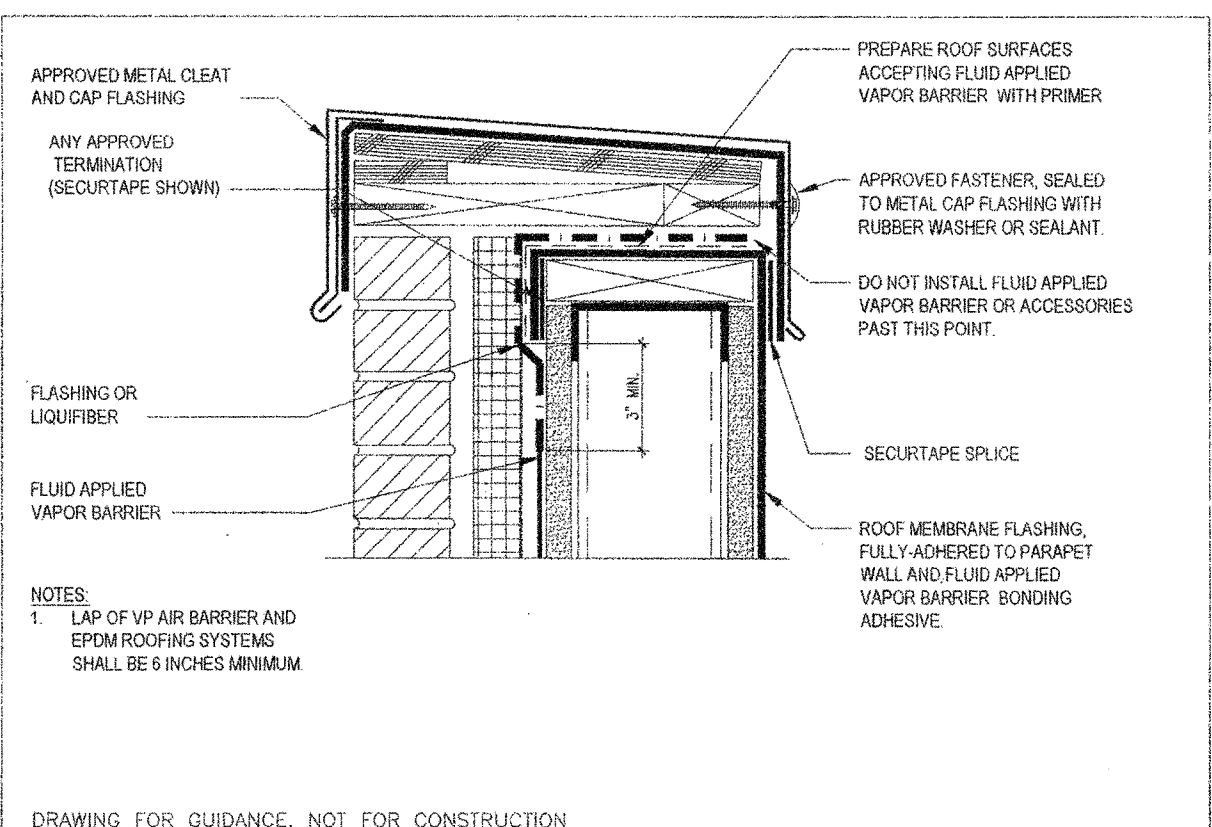

8 AIR BARRIER DETAIL - ROOF CAP TIE-IN
A5.11 SCALE: N.T.S

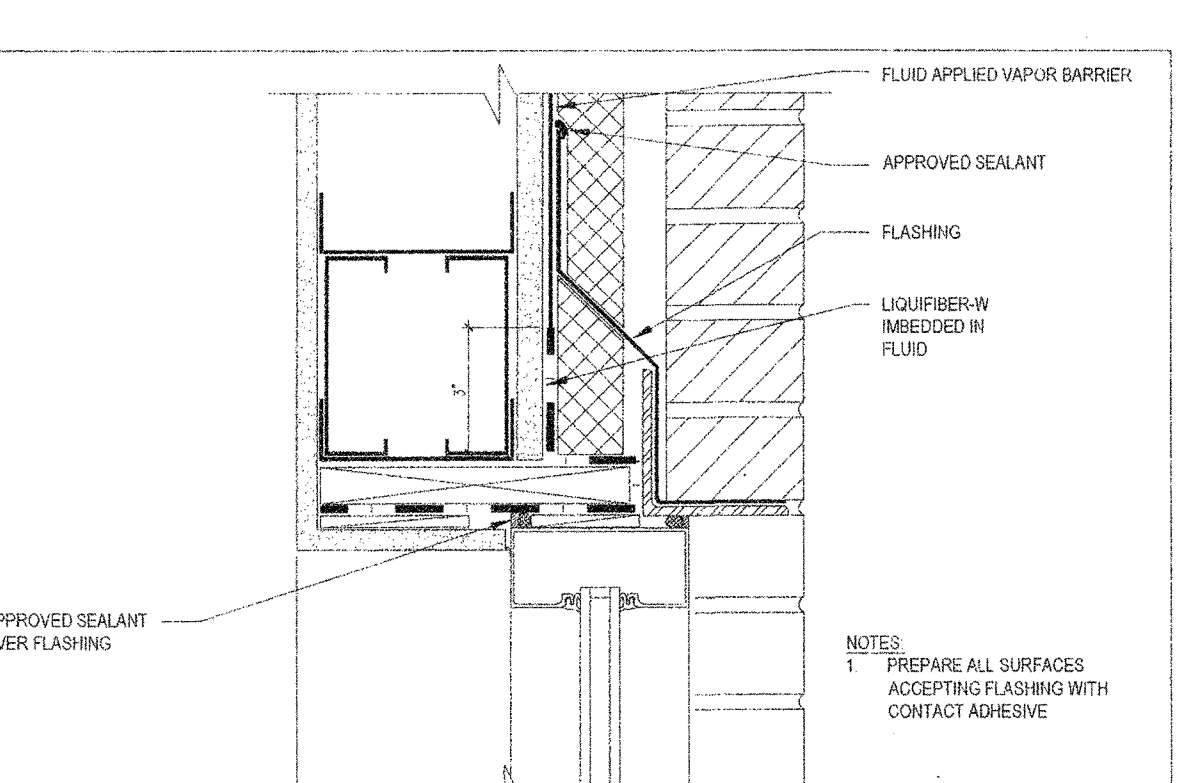

4 AIR BARRIER DETAIL - STOREFRONT - HEAD
A5.11 SCALE: N.T.S

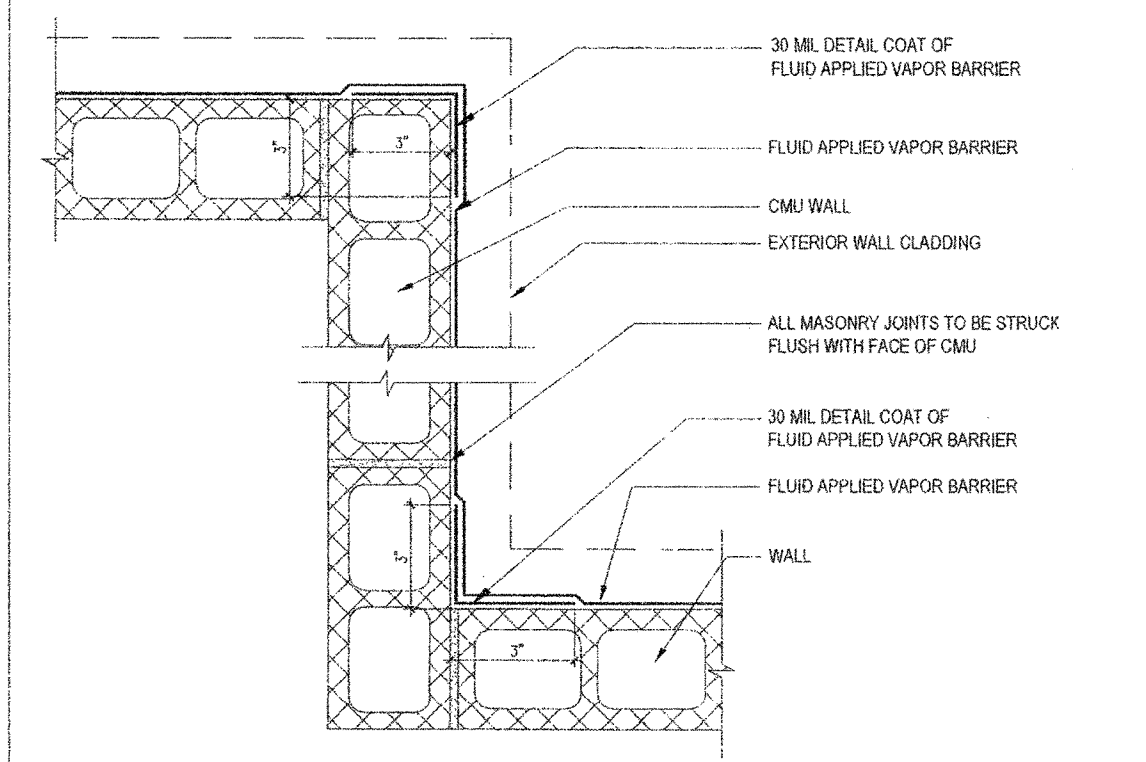

15 AIR BARRIER DETAIL - INSIDE/OUTSIDE CORNERS
A5.11 SCALE: N.T.S

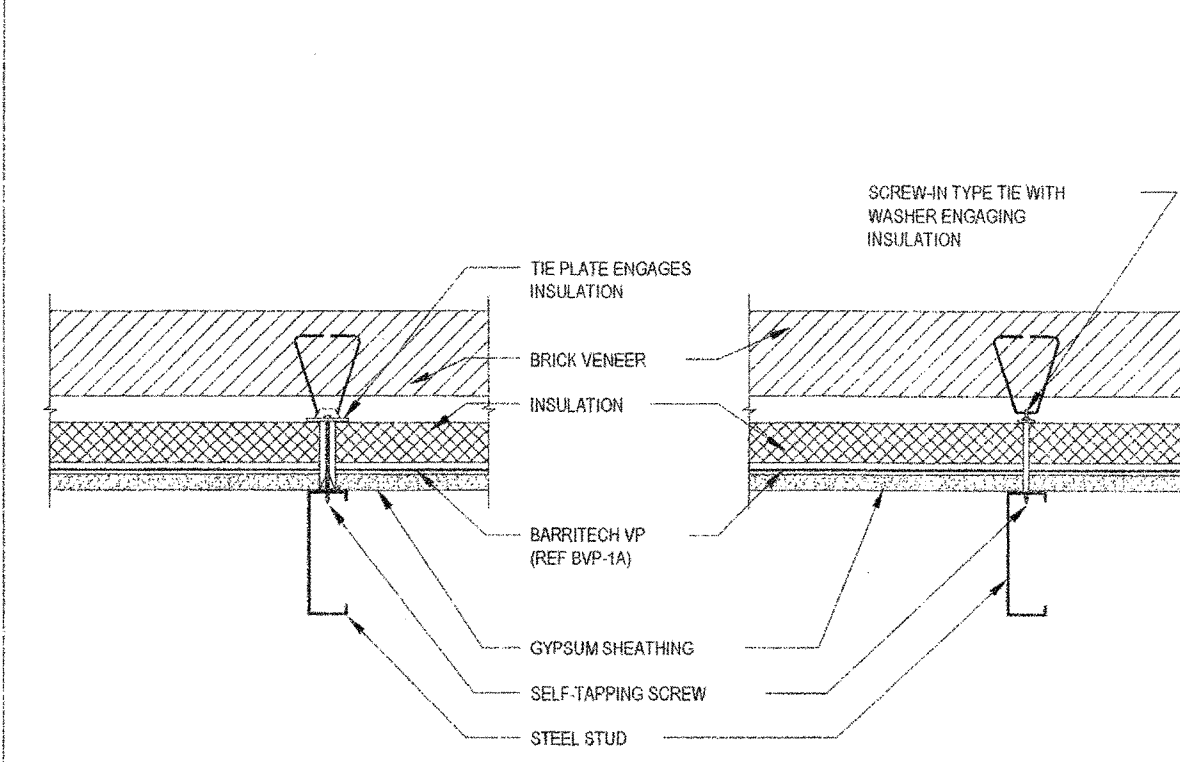

11 AIR BARRIER DETAIL - BRICK TIES III
A5.11 SCALE: N.T.S

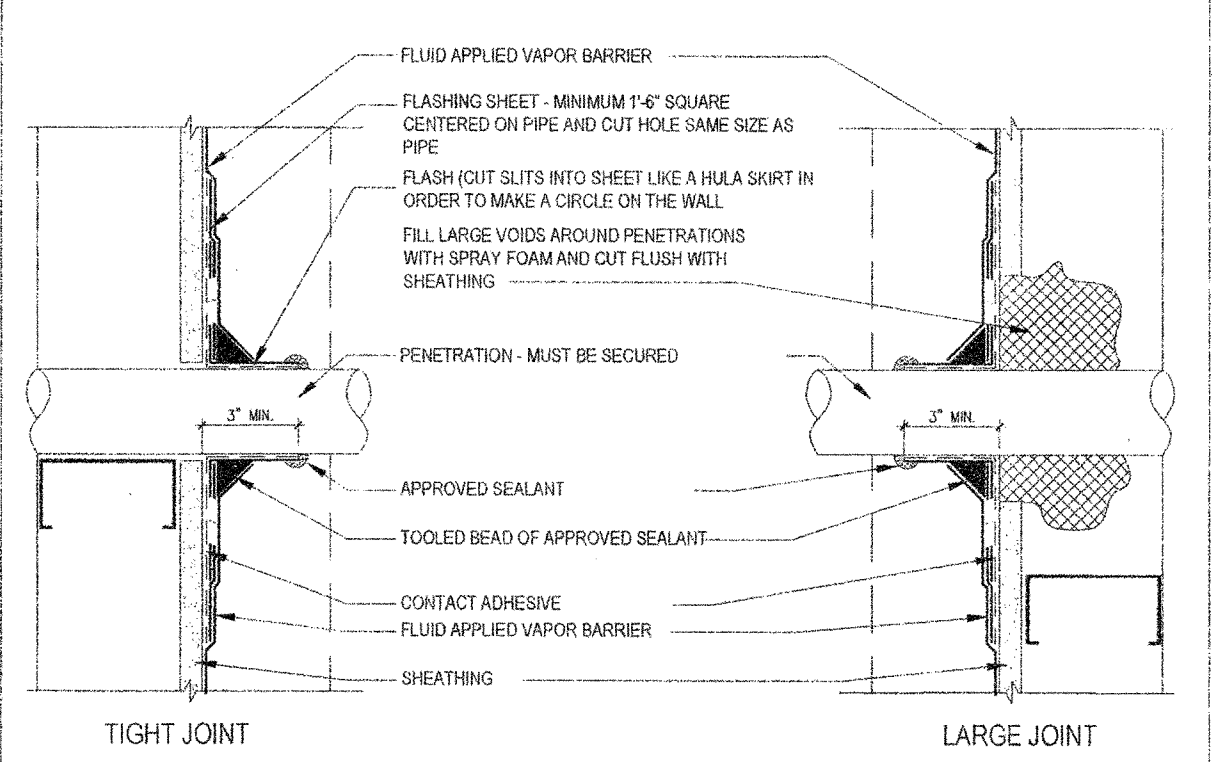

7 AIR BARRIER DETAIL - WALL PENETRATION
A5.11 SCALE: N.T.S

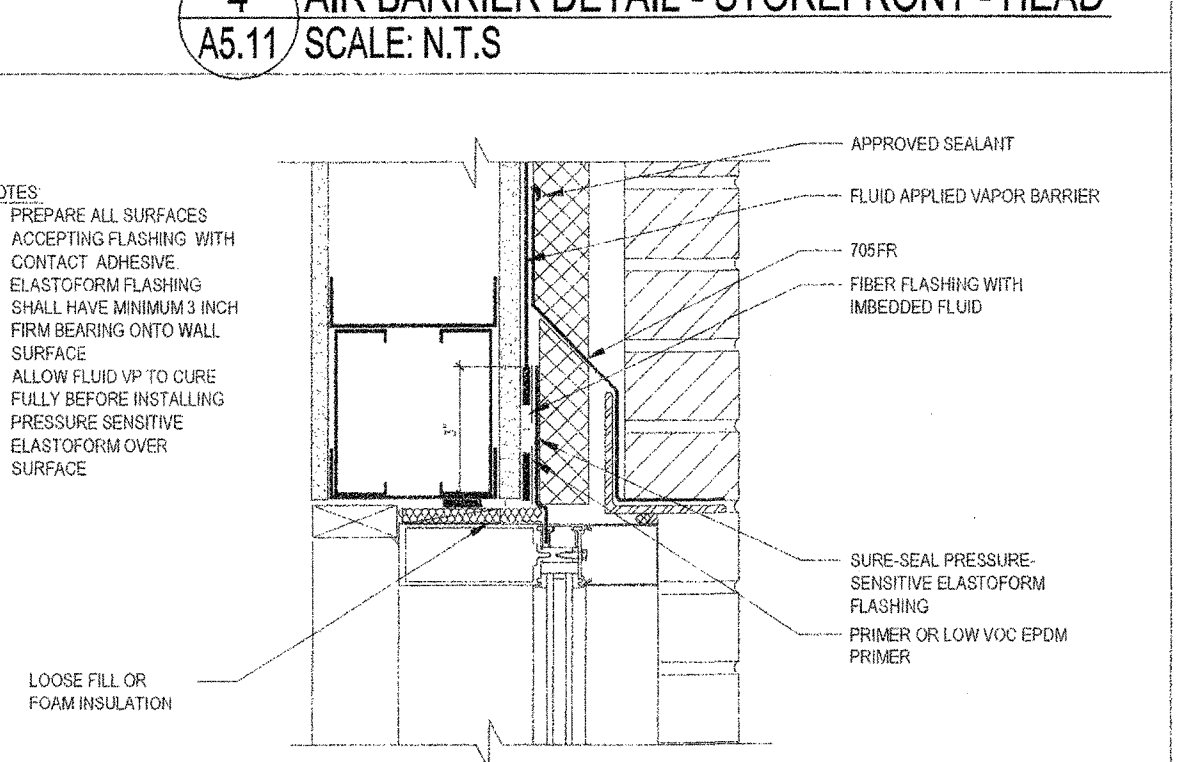

3 AIR BARRIER DETAIL - CURTAIN WALL - HEAD
A5.11 SCALE: N.T.S

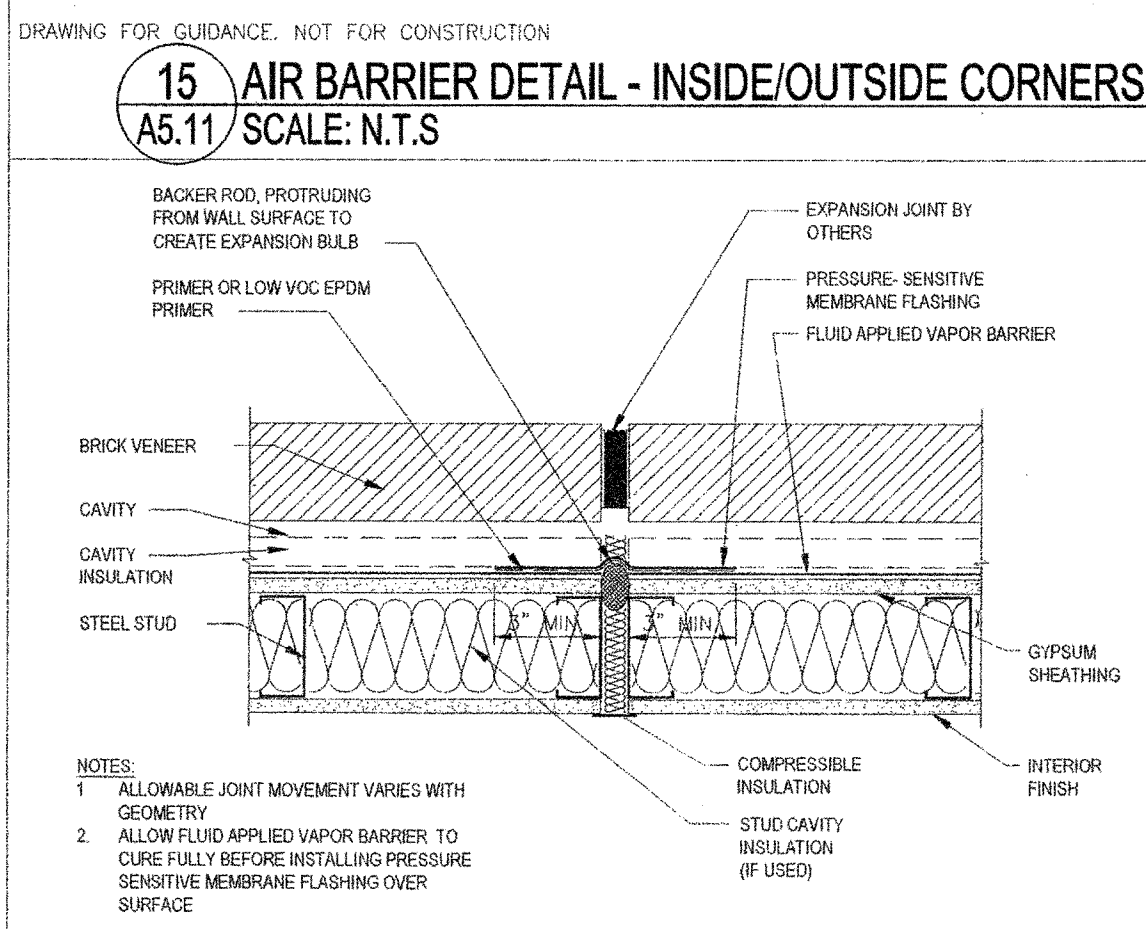

14 AIR BARRIER DETAIL - EXPANSION JOINT
A5.11 SCALE: N.T.S

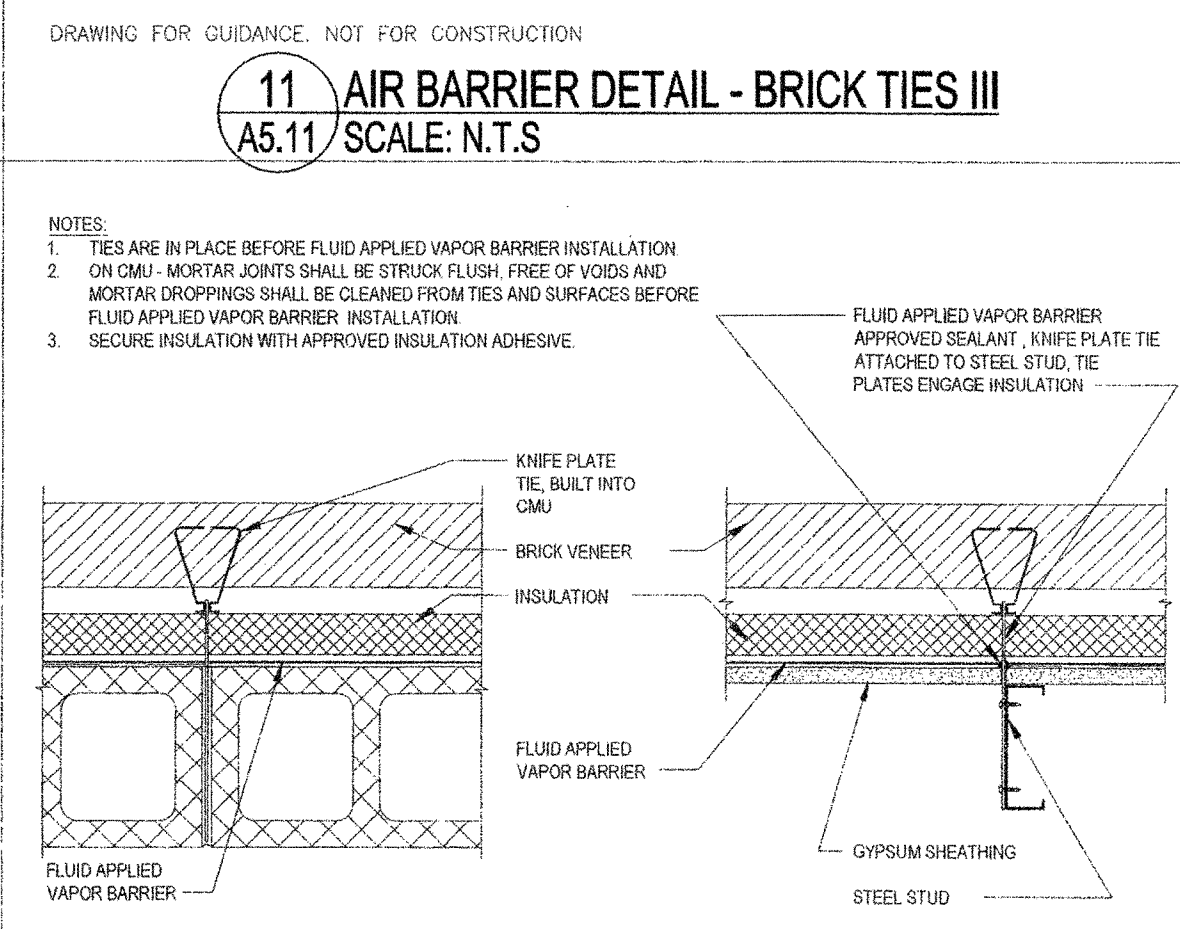

10 AIR BARRIER DETAIL - BRICK TIES II
A5.11 SCALE: N.T.S

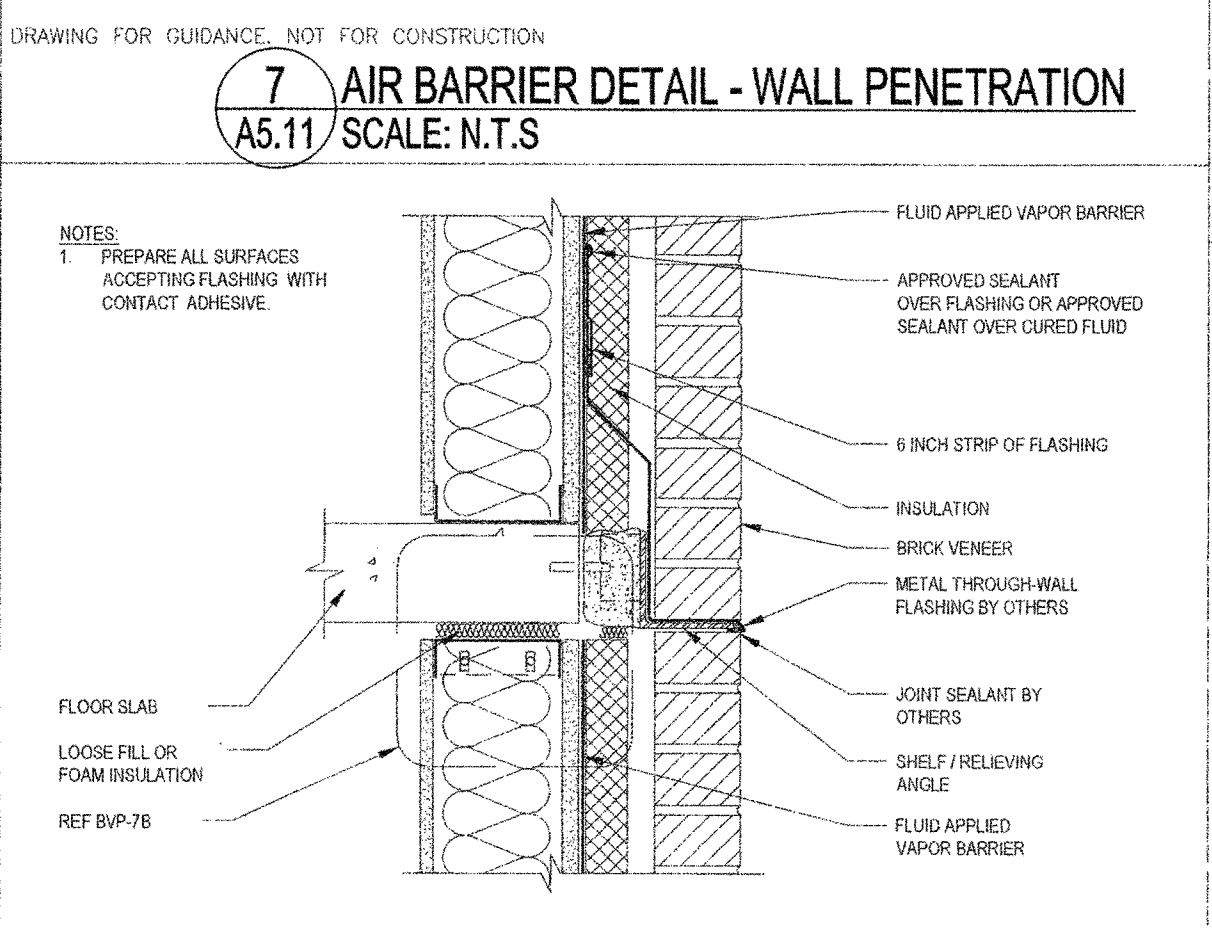

6 AIR BARRIER DETAIL - SHELF ANGLE
A5.11 SCALE: N.T.S

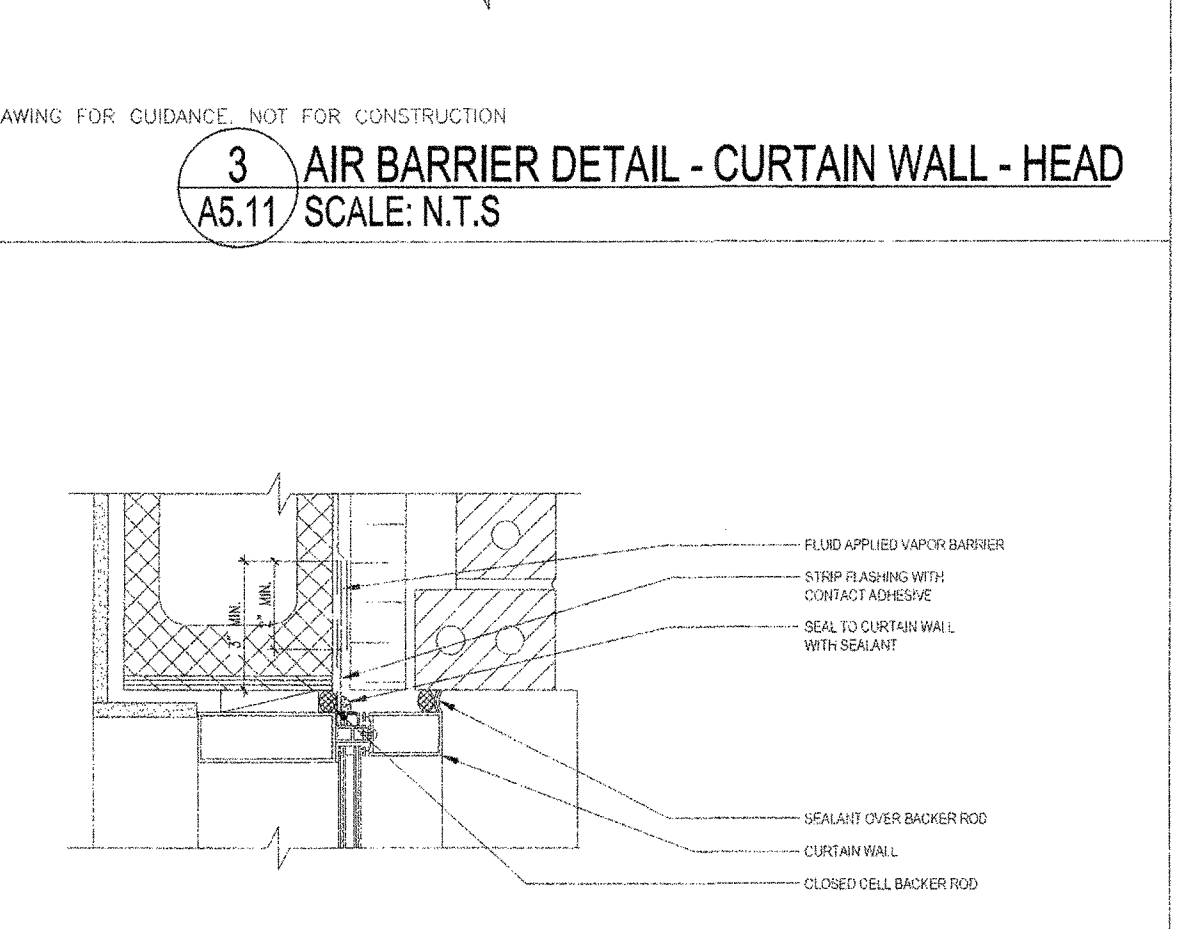

2 AIR BARRIER DETAIL - CURTAIN WALL - JAMB
A5.11 SCALE: N.T.S

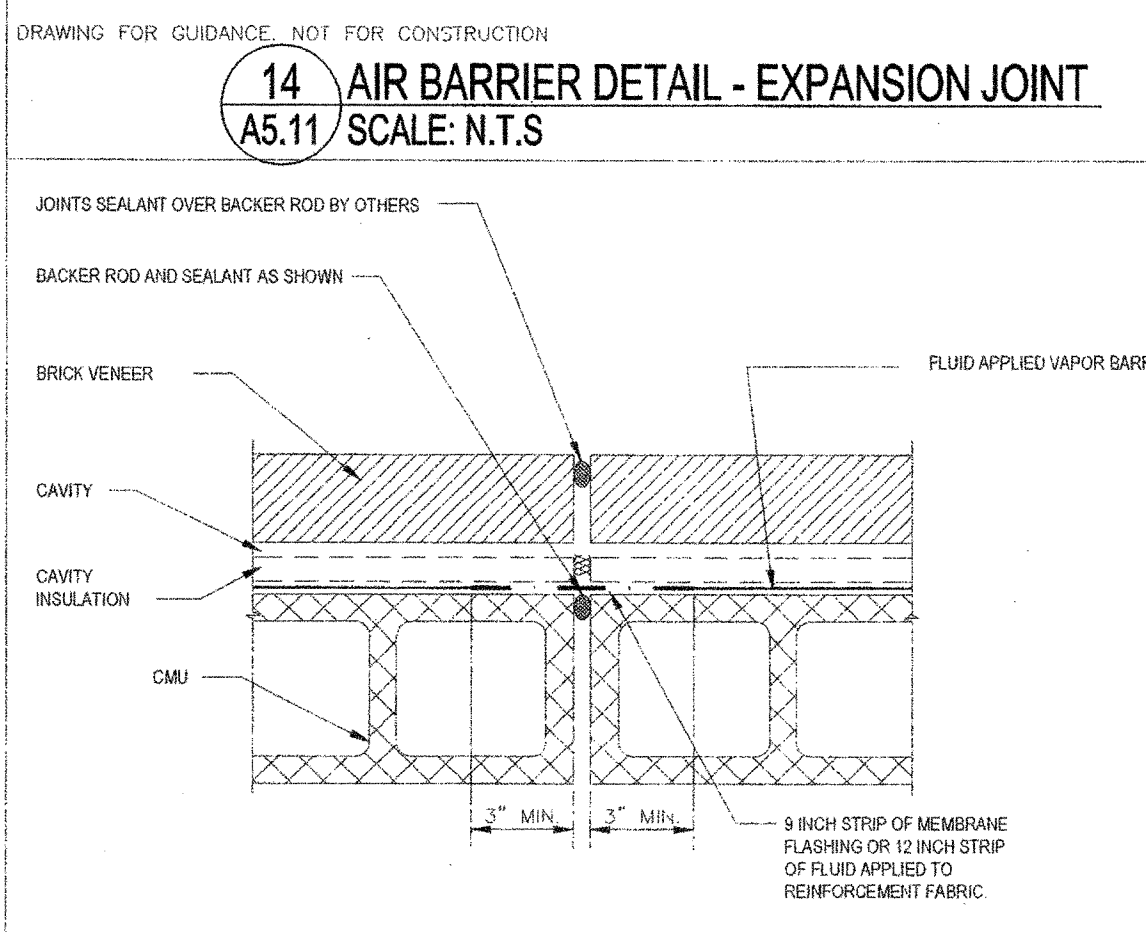

13 AIR BARRIER DETAIL - CONTROL JOINT
A5.11 SCALE: N.T.S

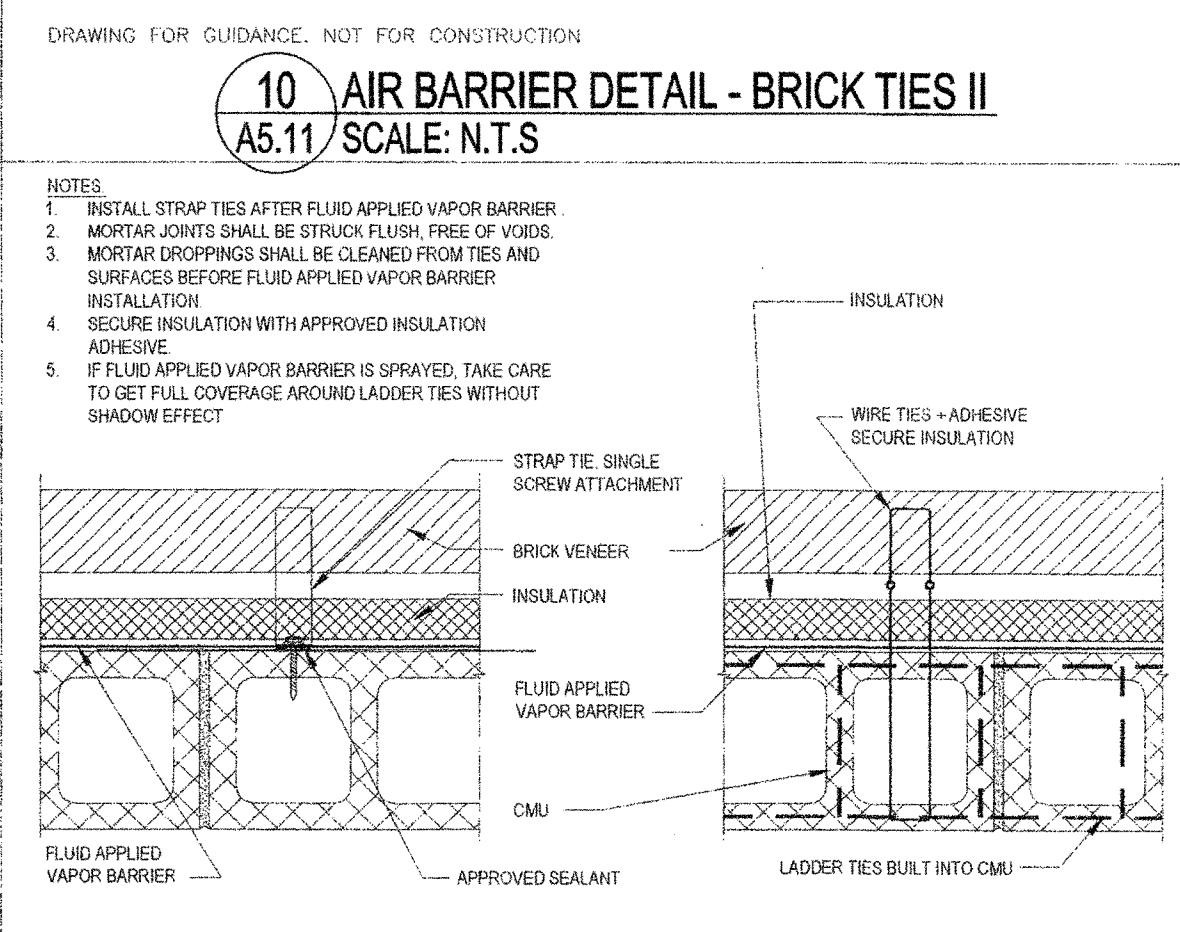

9 AIR BARRIER DETAIL - BRICK TIES I
A5.11 SCALE: N.T.S

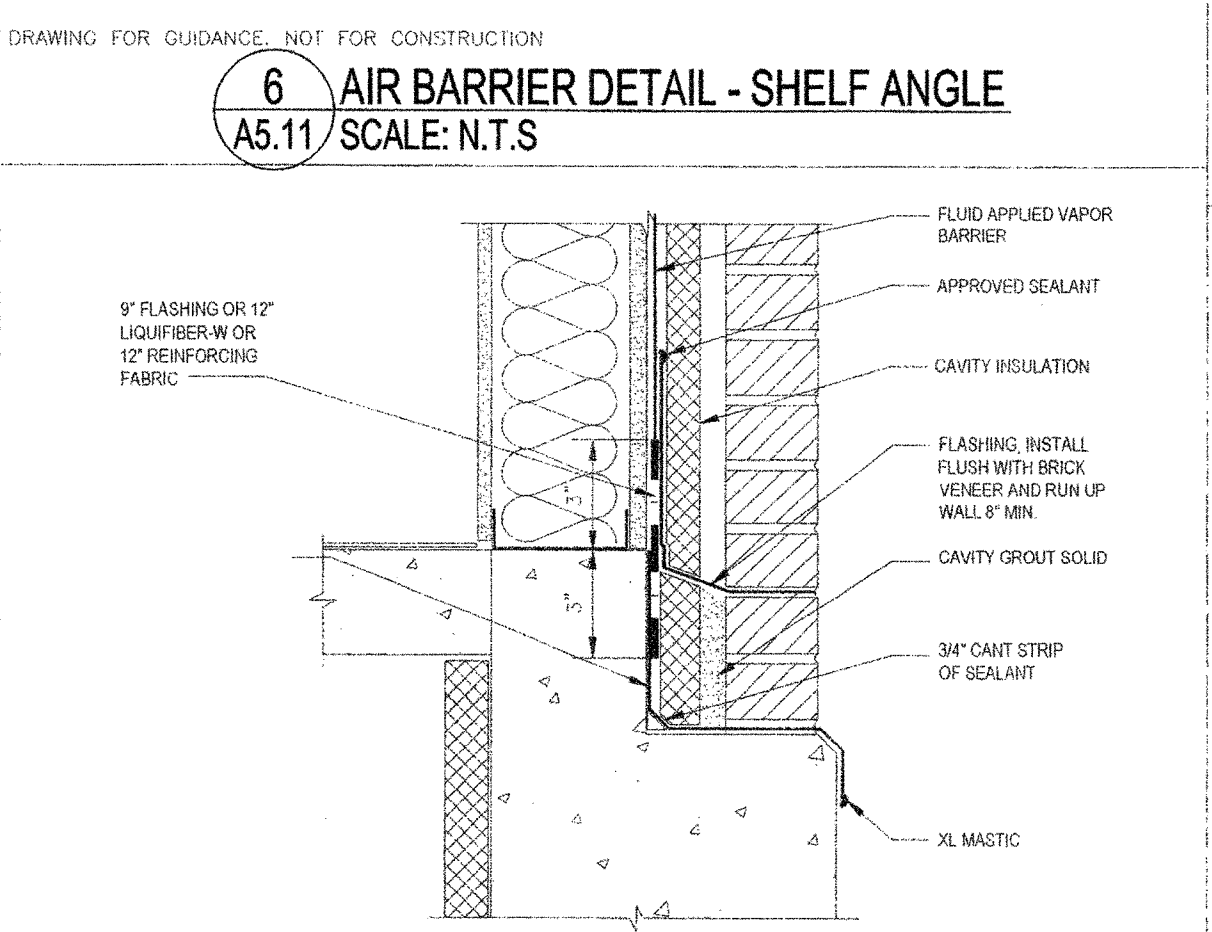

5 AIR BARRIER DETAIL - BRICK LEDGE
A5.11 SCALE: N.T.S

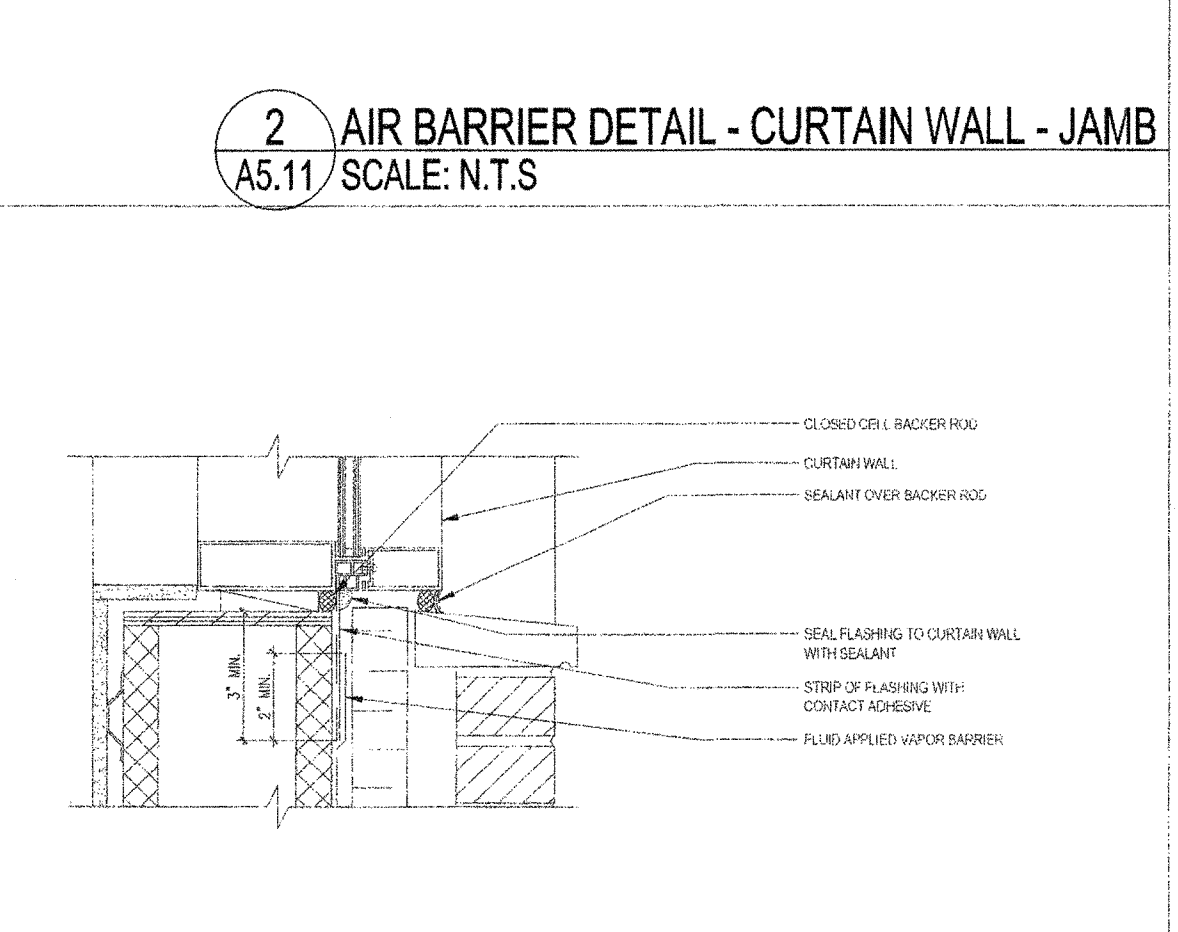

1 AIR BARRIER DETAIL - CURTAIN WALL - SILL
A5.11 SCALE: N.T.S

AIR BARRIER NOTES:

1. THIS SHEET IS PROVIDED FOR GUIDANCE DURING BIDDING ONLY. SHOP DRAWINGS ARE REQUIRED FOR ACTUAL CONSTRUCTION DETAILS.
2. DETAILS ARE SHOWING GENERAL MANUFACTURE'S CONDITIONS AND ARE NOT INTENDED TO SHOW ALL CONDITIONS REQUIRED FOR THIS PROJECT
3. DETAILS SHOWN ARE FROM ONE MANUFACTURE. DETAILS MAY CHANGE FOR ANOTHER'S MANUFACTURE. TO ANOTHER. APPROVED SHOP DRAWINGS FOR ACTUAL CONSTRUCTION DETAILS ARE REQUIRED.

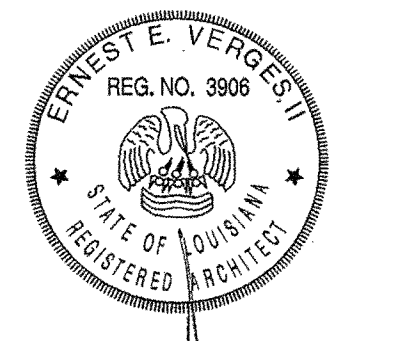

**NEW 3 SECTION ELEMENTARY SCHOOL
AT FISK-HOWARD SCHOOL
RECOVERY SCHOOL DISTRICT**
NEW ORLEANS, LOUISIANA 70119
211 S. LOPEZ STREET

DATE ISSUED: 7 DECEMBER, 2012

REVISED:	
REVISED:	
REVISED:	
REVISED:	

DRAWN BY: RMH
CHECKED BY: DGR, JFM
PHASE:

BID DOCUMENTS

11085

TITLE:
AIR BARRIER DETAILS

SHEET:

A5.11