



**Mike Holt's Illustrated Guide to
Understanding the NEC® Requirements for**

Article 680 Swimming Pools, Spas, Hot Tubs, Fountains, and Similar Installations

*Extracted from Mike Holt's Illustrated Guide to
Understanding the National Electrical Code, Volume 2
2008 Edition*



Mike Holt Enterprises, Inc.
888.NEC.CODE (632.2633) • www.MikeHolt.com • Info@MikeHolt.com

Swimming Pools, Spas, Hot Tubs, Fountains, and Similar Installations

INTRODUCTION TO ARTICLE 680—SWIMMING POOLS, SPAS, HOT TUBS, FOUNTAINS, AND SIMILAR INSTALLATIONS

The requirements contained in Article 680 apply to the installation of electric wiring and equipment for swimming pools, hot tubs, spas, fountains, and hydromassage bathtubs. The overriding concern of Article 680 is to keep people and electricity separated.

PART I. GENERAL REQUIREMENTS FOR POOLS, SPAS, HOT TUBS, AND FOUNTAINS

Author's Comment: The requirements contained in Part I of Article 680 apply to permanently installed pools [680.20], storable pools [680.30], outdoor spas and hot tubs [680.42], and fountains [680.50].

680.1 Scope. The requirements contained in Article 680 apply to the installation of electric wiring and equipment for swimming pools, hot tubs, spas, fountains, and hydromassage bathtubs.

680.2 Definitions.

Forming Shell. A structure mounted in the wall of permanently installed pools, storable pools, outdoor spas, outdoor hot tubs, or fountains designed to support a wet-niche luminaire.

Fountain. An ornamental pool, display pool, or reflection pool.

Hydromassage Bathtub. A permanently installed bathtub with a recirculating piping system designed to accept, circulate, and discharge water after each use.

Maximum Water Level. The highest level that water reaches before it spills out. **Figure 680-1**

Permanently Installed Swimming, Wading, Immersion, and Therapeutic Pools. Those constructed in the ground or partially in the ground, and all others capable of holding water in a depth greater than 42 in., and all pools installed inside of

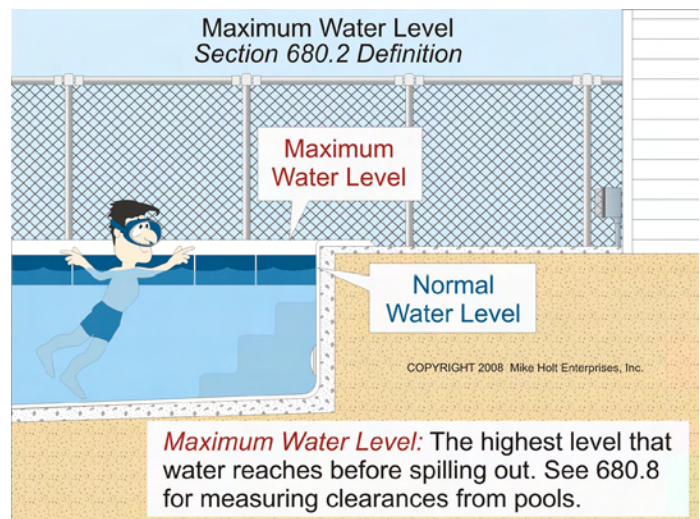

Figure 680-1

a building, regardless of water depth, whether or not served by electrical circuits of any nature.

Author's Comment: The definition of a pool includes Baptisteries (immersion pools), which must comply with the requirements of Article 680.

Pool. Manufactured or field-constructed equipment designed to contain water on a permanent or semipermanent basis and used for swimming, wading, immersion, or other purposes.

Spa or Hot Tub. A hydromassage pool or tub designed for recreational use typically not drained after each use.

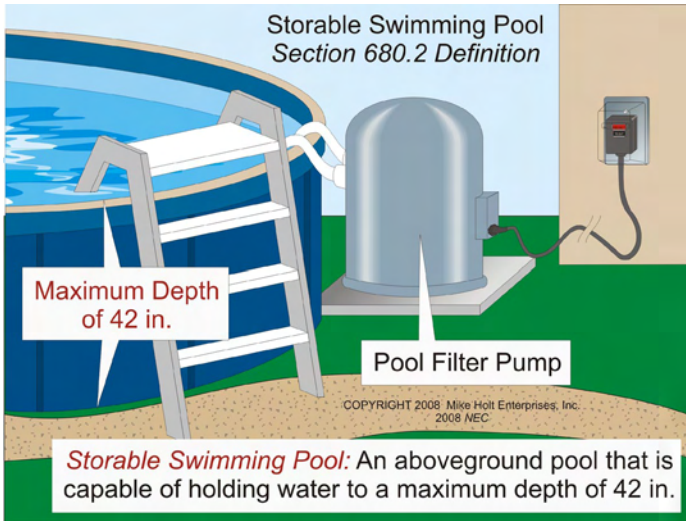

Figure 680-2

Storable Swimming Pool. An aboveground pool with a maximum water depth of 42 in. **Figure 680-2**

Author's Comment: Storable pools are sold as a complete package that consists of the pool walls, vinyl liner, plumbing kit, and pump/filter device. Underwriters Laboratories Inc. (UL) requires the pump/filter units to have a minimum 25 ft cord to discourage the use of extension cords.

Wet-Niche Luminaire. A luminaire intended to be installed in a forming shell where the luminaire will be completely surrounded by water.

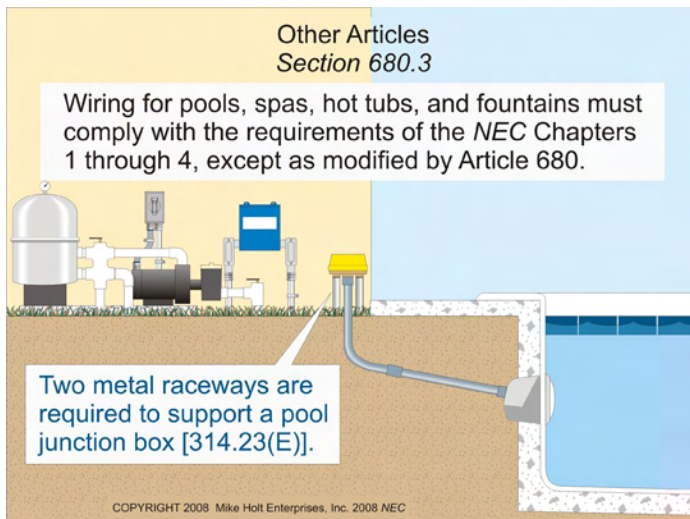

Figure 680-3

680.3 Other Articles. The wiring of permanently installed pools, storable pools, outdoor spas, outdoor hot tubs, or fountains must comply with Chapters 1 through 4, except as modified by this article. **Figure 680-3**

680.7 Cord-and-Plug-Connected Equipment. Fixed or stationary equipment other than an underwater luminaire for permanently installed pools, storable pools, outdoor spas, outdoor hot tubs, or fountains can be cord-and-plug-connected to facilitate removal or disconnection for maintenance or repair.

(A) Length. Except for storable pools, the cord must not exceed 3 ft.

Author's Comment: The NEC doesn't specify a maximum cord length for a storable pool pump motor.

(B) Equipment Grounding Conductor. The cord must have a copper equipment grounding conductor not smaller than 12 AWG and the cord must terminate at a grounding-type attachment plug.

680.8 Overhead Conductor Clearance. Overhead conductors must meet the clearance requirements contained in Table 680.8. The clearance is measured from the maximum water level.

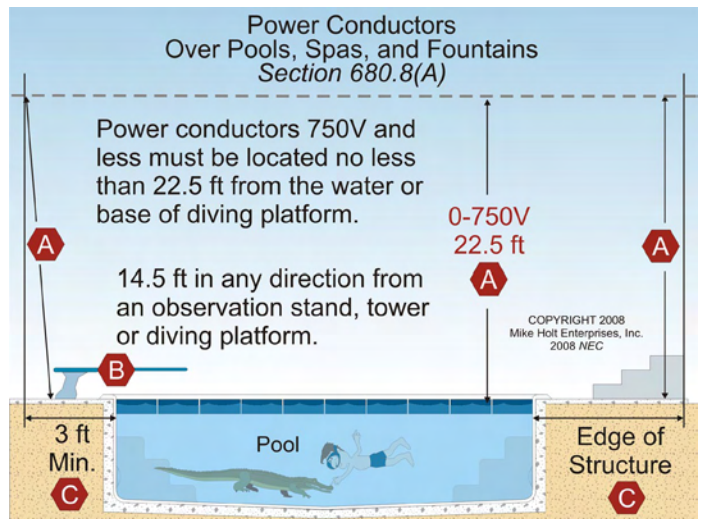

Figure 680-4

(A) Overhead Power Conductors. Permanently installed pools, storable pools, outdoor spas, outdoor hot tubs, fountains, diving structures, observation stands, towers, or platforms must not be placed within the clearances contained in the *NEC*, Table 680.8. **Figure 680-4**

Author's Comment: This rule doesn't prohibit utility-owned overhead service-drop conductors from being installed over a permanently installed pool, storable pool, outdoor spa, outdoor hot tub, or fountain [90.2(B)(5)]. It does prohibit a permanently installed pool, storable pool, outdoor spa, outdoor hot tub, or fountain from being installed under an existing service drop that isn't at least 22½ ft above the water.

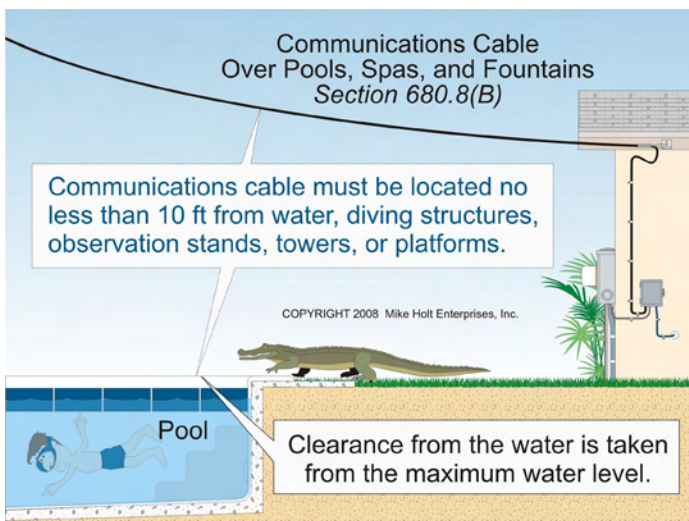

Figure 680-5

(B) Communications Systems. Permanently installed pools, storable pools, outdoor spas, outdoor hot tubs, fountains, diving structures, observation stands, towers, or platforms must not be placed under, or within, 10 ft of communications cables. **Figure 680-5**

Author's Comment: This rule doesn't prohibit a utility-owned communications overhead cable from being installed over a permanently installed pool, storable pool, outdoor spa, outdoor hot tub, or fountain [90.2(B)(4)]. It does prohibit a permanently installed pool, storable pool, outdoor spa, outdoor hot tub, or fountain from being installed under an existing communications utility overhead supply that isn't at least 10 ft above the water.

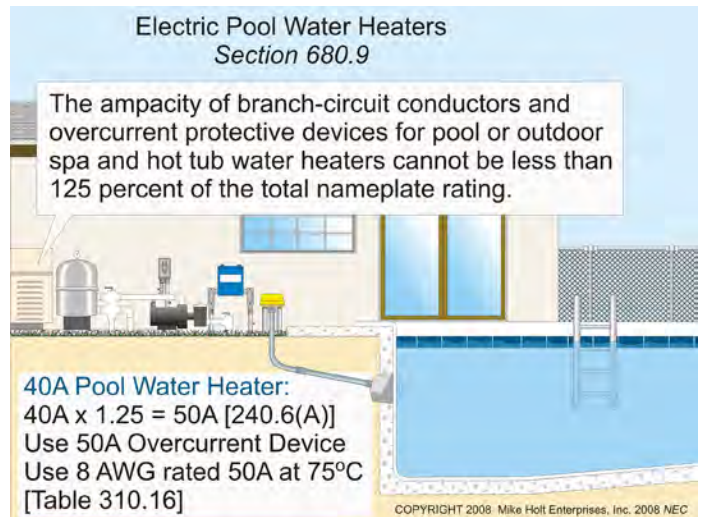

Figure 680-6

680.9 Electric Water Heater. The ampacity of branch-circuit conductors and overcurrent devices for pool or outdoor spa and hot tub water heaters must not be less than 125 percent of the total nameplate rating. **Figure 680-6**

680.10 Underground Wiring Location. Underground wiring isn't permitted under permanently installed pools, storable pools, outdoor spas, outdoor hot tubs, or fountains. Nor is it permitted within 5 ft horizontally from the inside wall of the pool, spa, hot tub, or fountain, unless necessary to supply the permanently installed pool, storable pool, outdoor spa, outdoor hot tub, or fountain equipment. **Figure 680-7**

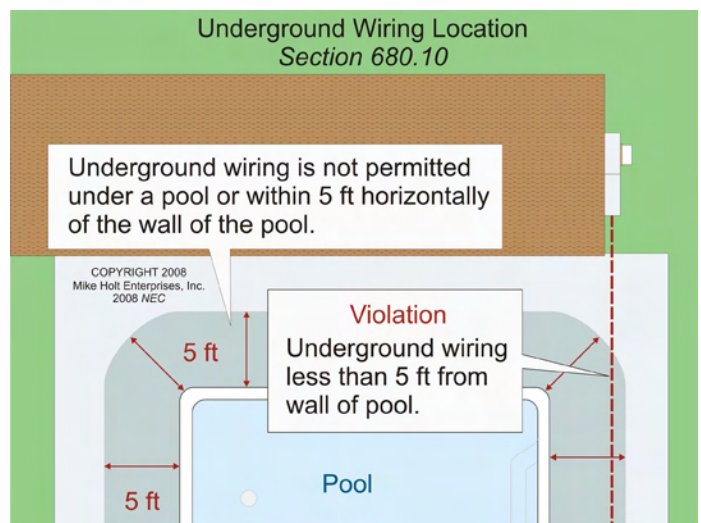

Figure 680-7

Where space limitations prevent wiring from being at least 5 ft away, underground wiring must be installed in complete raceway systems of rigid metal conduit, intermediate metal conduit, or PVC conduit listed for direct burial. The minimum cover is 6 in. for metal raceways and 18 in. for PVC conduits. **Figure 680–8**

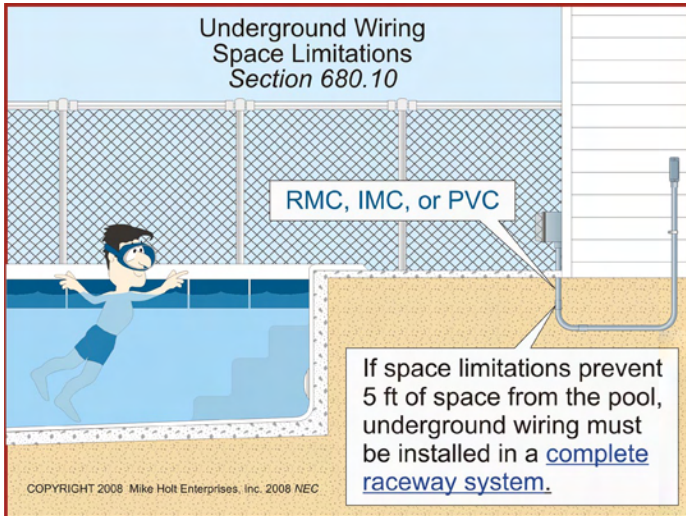

Figure 680–8

680.11 Equipment Rooms and Pits. A permanently installed pool, storable pool, outdoor spa, outdoor hot tub, or fountain equipment must not be located in rooms or pits that don't have adequate drainage to prevent water accumulation during normal operation or filter maintenance.

680.12 Maintenance Disconnecting Means. A maintenance disconnecting means is required for the permanently installed pool, storable pool, outdoor spa, outdoor hot tub, or fountain equipment, other than lighting for these water bodies.

The maintenance disconnecting means must be readily accessible and located within sight and at least 5 ft from the permanently installed pool, storable pool, outdoor spa, outdoor hot tub, or fountain equipment unless separated from the open water by a permanently installed barrier that provides a 5 ft reach path or greater. This horizontal distance is measured from the water's edge along the shortest path required to reach the disconnecting means. **Figure 680–9**

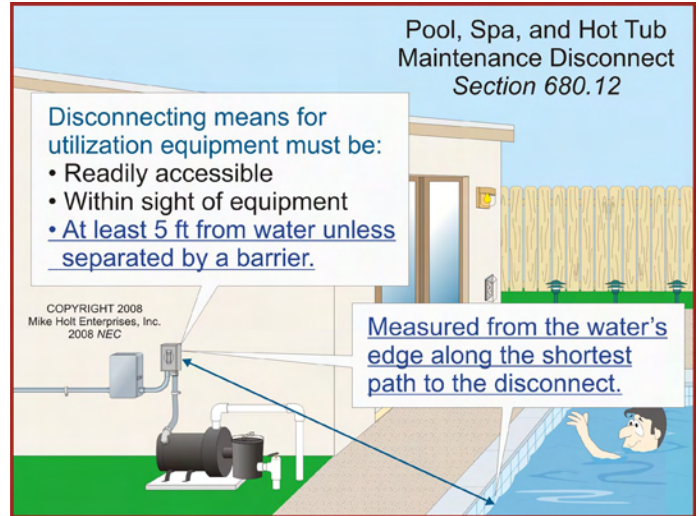

Figure 680–9

PART II. PERMANENTLY INSTALLED POOLS, OUTDOOR SPAS, AND OUTDOOR HOT TUBS

680.20 General. The installation requirements contained in Part I and Part II apply to permanently installed pools [680.20], outdoor spas, and outdoor hot tubs [680.42].

680.21 Motors.

(A) Wiring Methods. The wiring to a motor must comply with (A)(1) unless modified by (A)(2), (A)(3), (A)(4), or (A)(5). **Figure 680–10**

(1) General. Branch-circuit conductors for permanently installed pool, outdoor spa, and outdoor hot tub motors must be installed in rigid metal conduit, intermediate metal conduit, PVC conduit, or Type MC cable listed for the location (sunlight-resistant or for direct burial). The wiring methods must contain an insulated copper equipment grounding conductor sized in accordance with 250.122, but in no case can it be smaller than 12 AWG.

(2) On or Within Buildings. Where installed on or within buildings, electrical metallic tubing is permitted to supply permanently installed pool, outdoor spa, and outdoor hot tub motors.

Author's Comment: Where electrical metallic tubing is used, it must contain an insulated copper equipment grounding conductor as required by 680.21(A)(1).

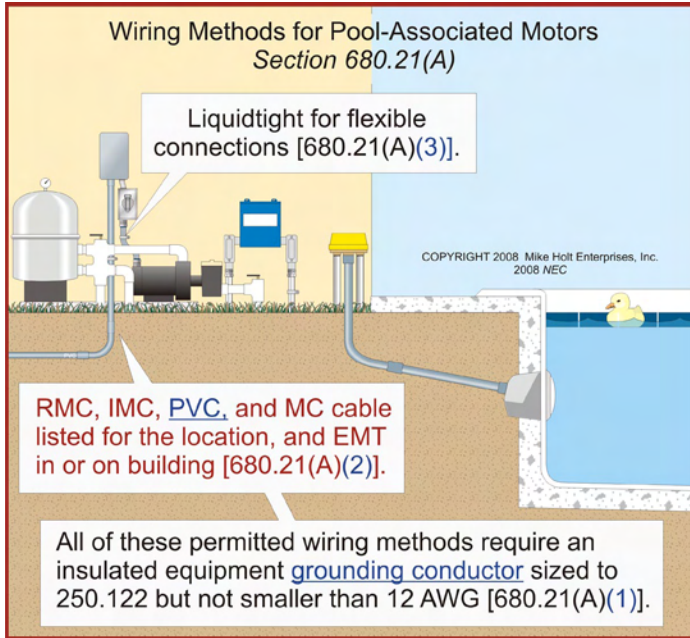

Figure 680-10

(3) Flexible Connections. Liquidtight flexible metal or liquidtight nonmetallic conduit is permitted for permanently installed pool, outdoor spa, and outdoor hot tub motors.

Author's Comment: Where liquidtight flexible metal or non-metallic conduit is used, it must contain an insulated copper equipment grounding conductor as required by 680.21(A)(1).

(4) One-Family Dwelling. In the interior of a dwelling unit or accessory building associated with a dwelling unit, any Chapter 3 wiring method is permitted. Where branch-circuit conductors are run in a raceway, the wiring method must contain an insulated copper equipment grounding conductor as required by 680.21(A)(1). Where a cable assembly is used, the circuit equipment grounding conductor can be uninsulated. **Figure 680-11**

(5) Cord-and-Plug Connections. A cord no longer than 3 ft, with an attachment plug and containing an equipment grounding conductor, sized in accordance with 250.122, is permitted for permanently installed pool motors. **Figure 680-12**

Author's Comment: For outdoor spas and hot tubs, the cord must be GFCI protected and it can be up to 15 ft long [680.42(A)(2)].

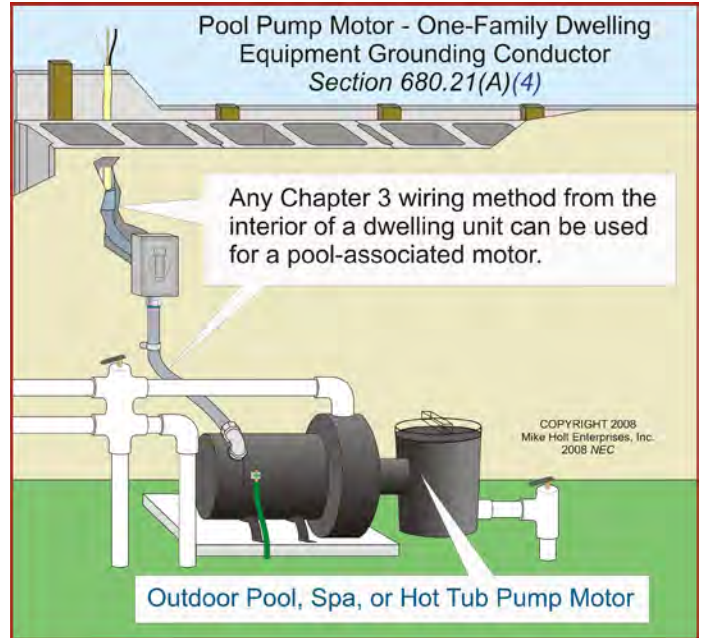

Figure 680-11

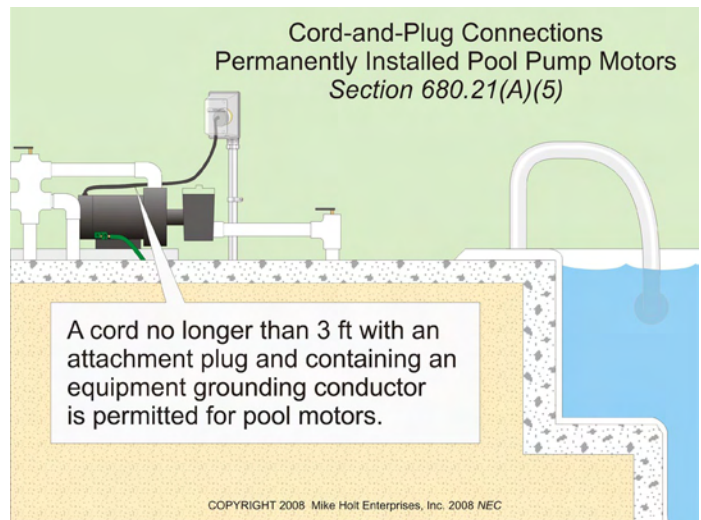

Figure 680-12

680.22 Area Lighting, Receptacles, and Equipment.

(A) Receptacles.

(1) Circulation System. Receptacles for permanently installed pool, outdoor spa, and outdoor hot tub motors, or other loads directly related to the circulation system must be located not less than 10 ft from the inside walls of a permanently installed pool, outdoor spa, or outdoor hot tub, or not less than 6 ft from the inside walls of a permanently

installed pool, outdoor spa, or outdoor hot tub if they meet all of the following conditions: **Figure 680-13**

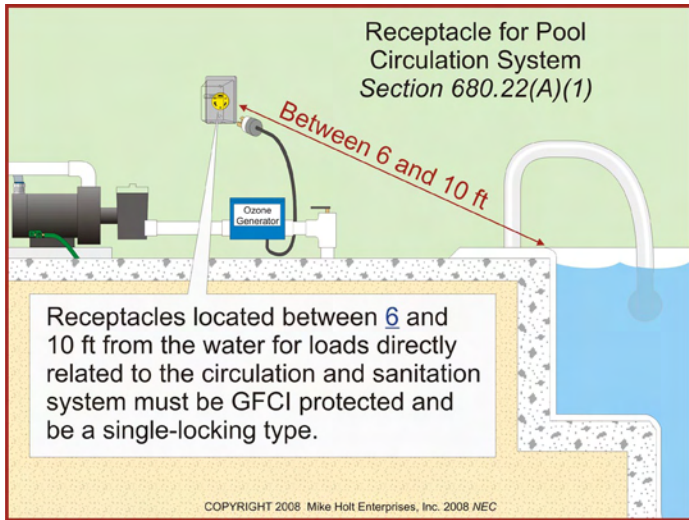

Figure 680-13

- (1) Consist of a single receptacle
- (2) Employ a locking configuration
- (3) Be of the grounding type
- (4) Have GFCI protection

(2) Other Receptacles. Receptacles not for motors or other loads directly related to the circulation system must be not less than 6 ft from the inside walls of a permanently installed pool, outdoor spa, or outdoor hot tub. **Figure 680-14**

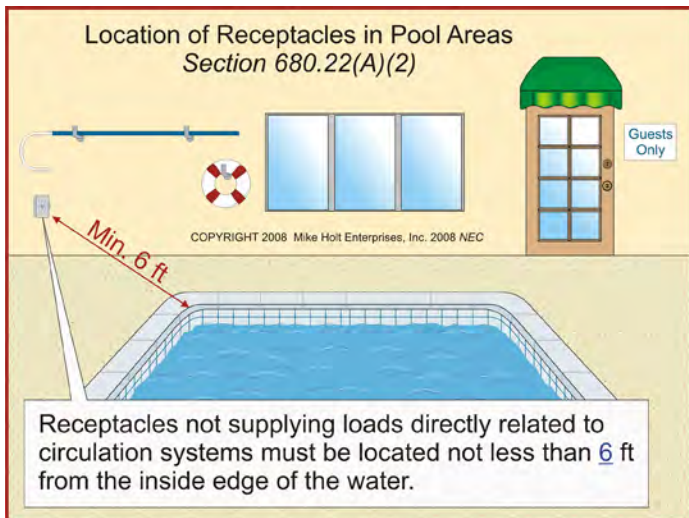

Figure 680-14

(3) Dwelling Unit. At a dwelling unit, one 15A or 20A, 125V receptacle must be located not less than 6 ft and not more than 20 ft from the inside walls of a permanently installed pool, outdoor spa, or outdoor hot tub. This receptacle must be located not more than 6½ ft above the floor, platform, or grade level serving the permanently installed pool, outdoor spa, or outdoor hot tub. **Figure 680-15**

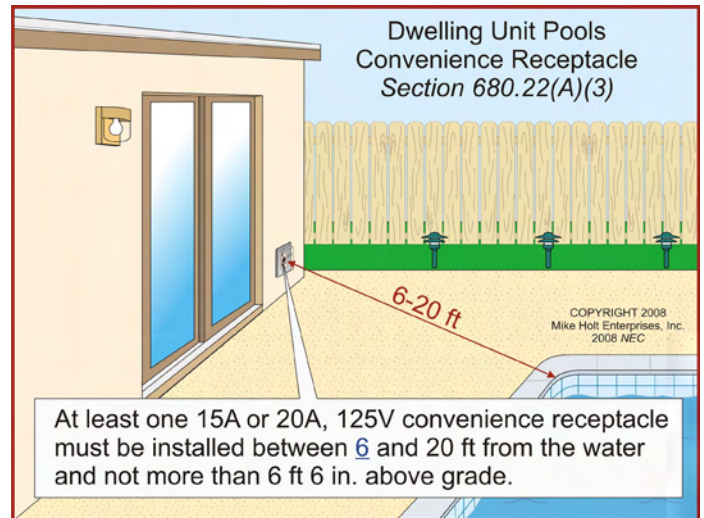

Figure 680-15

(4) GFCI-Protected Receptacles. All 15A and 20A, 125V receptacles located within 20 ft from the inside walls of a permanently installed pool, outdoor spa, or outdoor hot tub must be GFCI protected. **Figure 680-16**

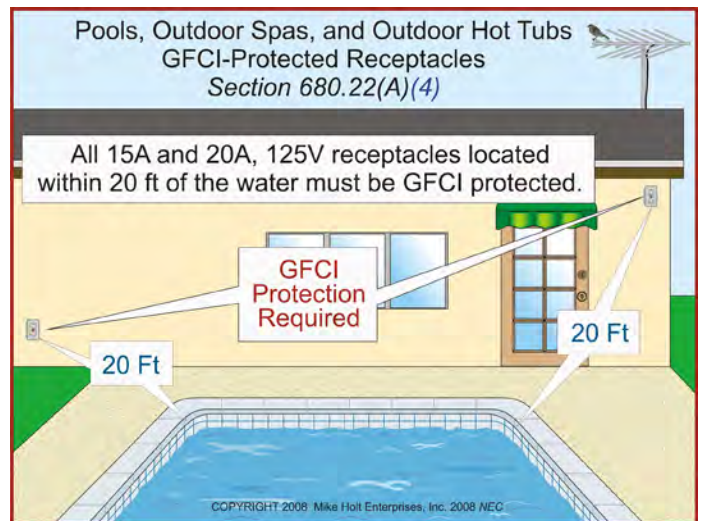

Figure 680-16

Author's Comments:

- Outdoor dwelling unit receptacles must be GFCI protected, regardless of the distance from a permanently installed pool, outdoor spa, or outdoor hot tub [210.8(A)(3)].
- All 15A and 20A, 125V receptacles for nondwelling units located outdoors require GFCI protection [210.8(B)(4)].

(5) Measurements. The receptacle distance is measured as the shortest path an appliance cord would follow without passing through a wall, doorway, or window.

(B) GFCI-Protected Motors. Outlets supplying pool pump motors for a permanently installed pool, outdoor spa, or outdoor hot tub from branch circuits rated 15A or 20A, 120V or 240V must be GFCI protected. **Figure 680-17**

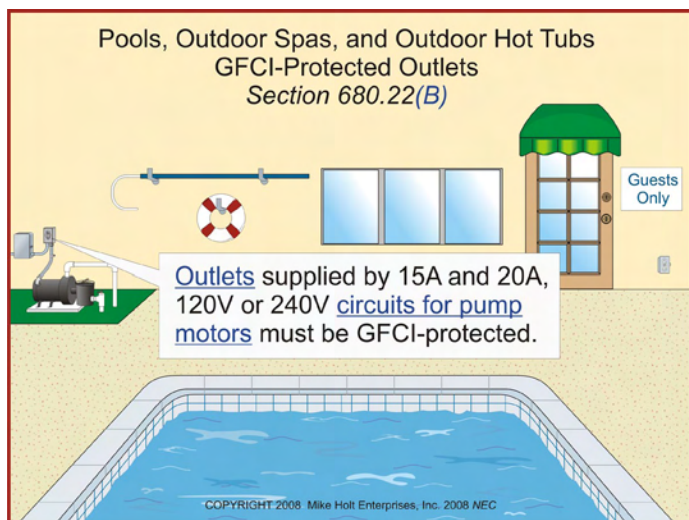

Figure 680-17

(C) Luminaires and Ceiling Fans.

(1) New Outdoor Installations. Luminaires and ceiling fans installed above the water, or the area extending within 5 ft horizontally from the inside walls of a permanently installed pool, outdoor spa, or outdoor hot tub, must not be less than 12 ft above the maximum water level.

(3) Existing Installations. Existing luminaires located less than 5 ft horizontally from the inside walls of a permanently installed pool, outdoor spa, or outdoor hot tub must be not less than 5 ft above the surface of the maximum water level and must be GFCI protected. **Figure 680-18**

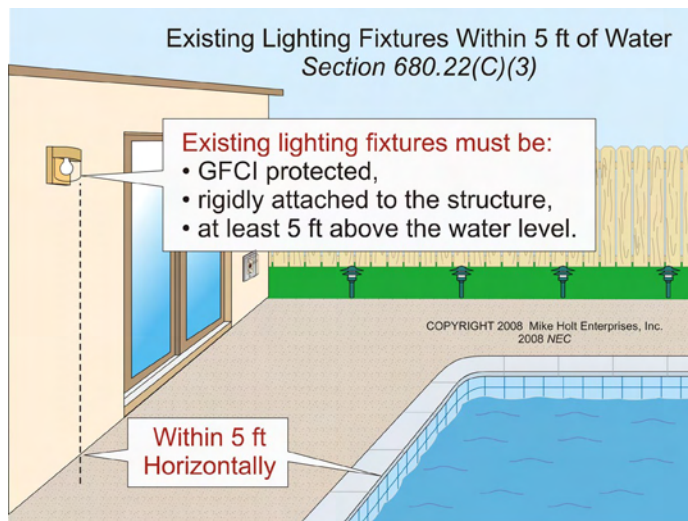

Figure 680-18

(4) Adjacent Areas. New luminaires installed between 5 ft and 10 ft horizontally, and not more than 5 ft above the maximum water level of a permanently installed pool, outdoor spa, or outdoor hot tub must be GFCI protected.

Author's Comment: Low-voltage lighting systems must not be located within 10 ft of a pool, spa, or hot tub, even if GFCI protected [411.4].

(D) Switching Devices. Circuit breakers, time clocks, pool light switches, and other switching devices must be located not less than 5 ft horizontally from the inside walls of a permanently installed pool, outdoor spa, or outdoor hot tub unless separated by a solid fence, wall, or other permanent barrier. **Figure 680-19**

(E) Other Outlets. Other outlets must not be located less than 10 ft from the inside walls of a permanently installed pool, outdoor spa, or outdoor hot tub. The receptacle distance is measured as the shortest path an appliance cord would follow without passing through a wall, doorway, or window [680.21(A)(5)].

FPN: Examples of other outlets may include remote-control, signaling, fire alarm, and communications circuits.

680.23 Underwater Luminaires.**(A) General.**

(2) Transformers. Transformers for underwater luminaires must be listed as a swimming pool transformer of the isolating-winding type and have a grounded metal barrier between the primary and secondary windings.

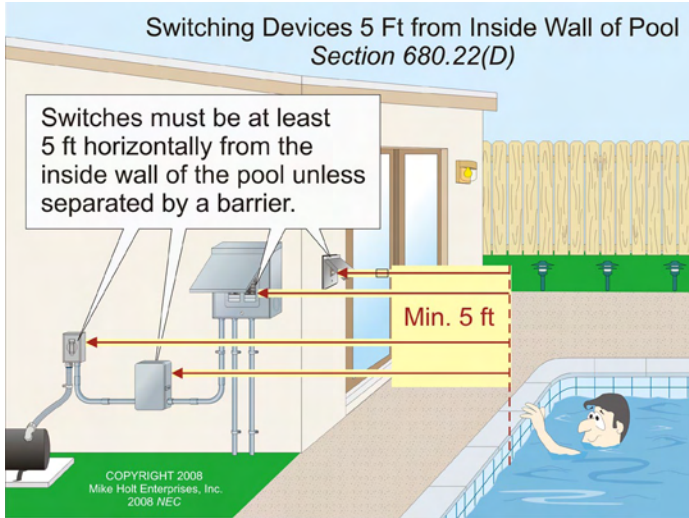

Figure 680-19

(3) GFCI Protection of Underwater Luminaires. Branch circuits that supply underwater luminaires operating at more than 15V must be GFCI protected. **Figure 680-20**

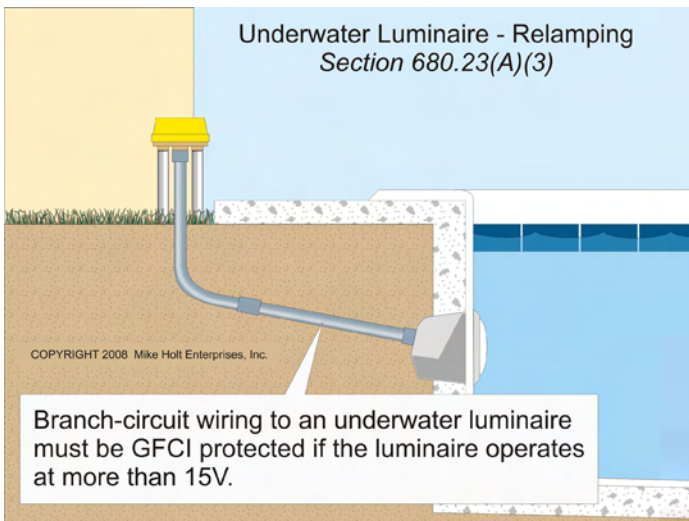

Figure 680-20

(5) Wall-Mounted Luminaires. Underwater luminaires must be installed so that the top of the luminaire lens isn't less than 18 in. below the normal water level.

Author's Comment: The 18-in. requirement reduces the likelihood that persons hanging on the side of the pool will have their chest cavity in line with the underwater luminaire.

(B) Wet-Niche Underwater Luminaires.

(1) Forming Shells. Forming shells for wet-niche underwater luminaires must be equipped with provisions for conduit entries. All forming shells used with PVC conduit systems must include provisions for terminating an 8 AWG copper conductor.

(2) Wiring to the Forming Shell. The conduit that extends directly to the underwater pool wet-niche forming shell must comply with (a) or (b).

(a) Metal Conduit. Brass or corrosion-resistant rigid metal conduit approved by the authority having jurisdiction.

(b) Nonmetallic Conduit. Nonmetallic conduit containing an 8 AWG insulated (solid or stranded) copper bonding jumper, must terminate in the forming shell and junction box unless a listed low-voltage lighting system not requiring grounding is used. **Figures 680-21** and **680-22**

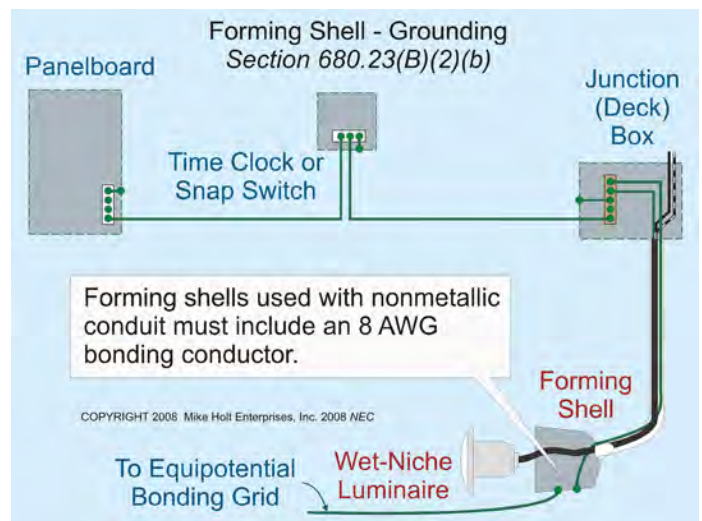

Figure 680-21

The termination of the 8 AWG bonding jumper in the forming shell must be covered with a listed potting compound to protect the connection from the possible deteriorating effect of pool water.

(6) Servicing. The forming shell location and length of cord in the forming shell must allow for personnel to place the removed luminaire on the deck or other dry location for maintenance. The luminaire maintenance location must be accessible without entering or going in the pool water. **Figure 680-23**

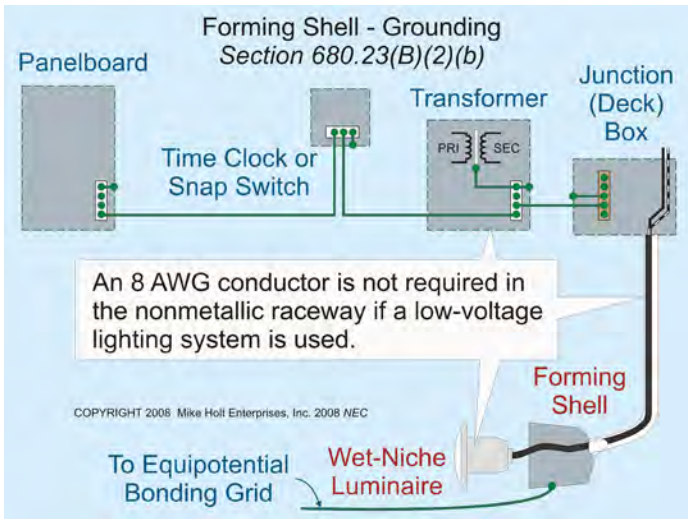

Figure 680-22

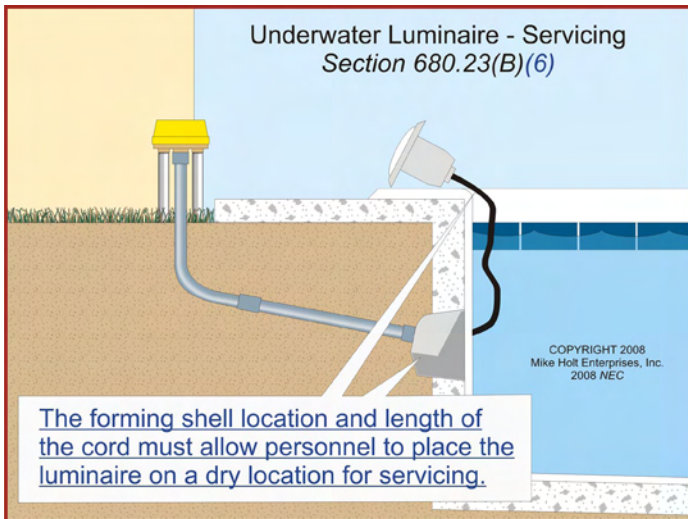

Figure 680-23

Author's Comment: While it may be necessary to enter the pool water, possibly with underwater breathing apparatus in some cases, the cord must be long enough to allow the luminaire to be brought out and placed on a deck or other dry location where the relamping, maintenance, or inspection can take place without entering the pool water.

(F) Branch-Circuit Wiring.

(1) Wiring Methods. Branch-circuit wiring for underwater luminaires must be rigid metal conduit, intermediate metal conduit, liquidtight flexible nonmetallic conduit, or PVC conduit [680.23(B)(2)]. Electrical metallic tubing can be installed on a building.

Where installed on buildings, electrical metallic tubing is permitted, and where installed within buildings, electrical non-metallic tubing, Type MC cable, electrical metallic tubing, or Type AC cable is permitted. The wiring methods must contain an insulated copper equipment grounding conductor sized in accordance with 250.122, but in no case can it be smaller than 12 AWG.

Exception: Where connecting to transformers for pool lights, liquidtight flexible metal conduit or liquidtight flexible nonmetallic conduit is permitted in individual lengths not exceeding 6 ft.

(2) Equipment Grounding Conductor. Branch-circuit conductors for an underwater luminaire must contain an insulated copper equipment grounding conductor sized in accordance with 250.122, but not smaller than 12 AWG. **Figure 680-24**

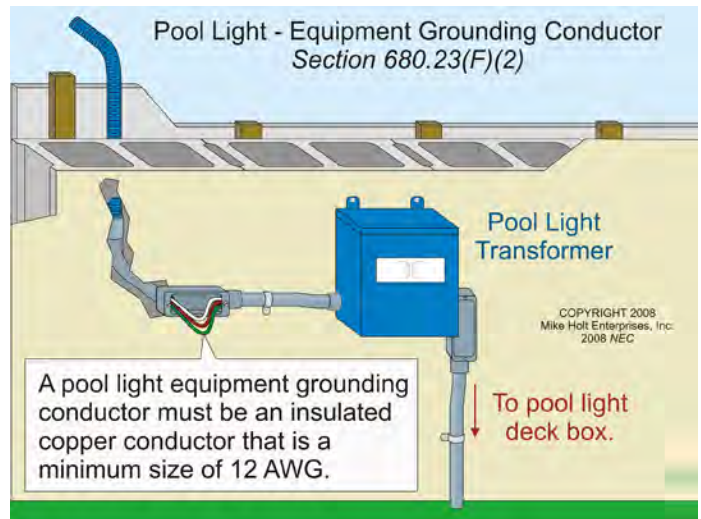

Figure 680-24

The circuit equipment grounding conductor for the underwater luminaire must not be spliced, except as permitted in (a) or (b).

- (a) Where more than one underwater luminaire is supplied by the same branch circuit, the circuit equipment grounding conductor can terminate at a listed pool junction box that meets the requirements of 680.24(A).
- (b) The circuit equipment grounding conductor can terminate at the grounding terminal of a listed pool transformer that meets the requirements of 680.23(A)(2).

(3) Conductors. The branch-circuit conductors on the load side of a GFCI or transformer for underwater luminaires must not occupy raceways or enclosures containing other conductors unless one of the following conditions applies:

- (1) The other conductors are GFCI protected.
- (2) The other conductors are equipment grounding conductors.
- (3) The other conductors are the supply conductors to a feed-through type GFCI.
- (4) The GFCI protected conductors are within a panelboard.

680.24 Junction Box, Transformer, or GFCI Enclosure.

(A) Junction Box. The junction box (deck box) that connects directly to an underwater permanently installed pool, outdoor spa, or outdoor hot tub luminaire forming shell must comply with the following: **Figure 680-25**

(1) Construction. The junction box must be listed as a swim-

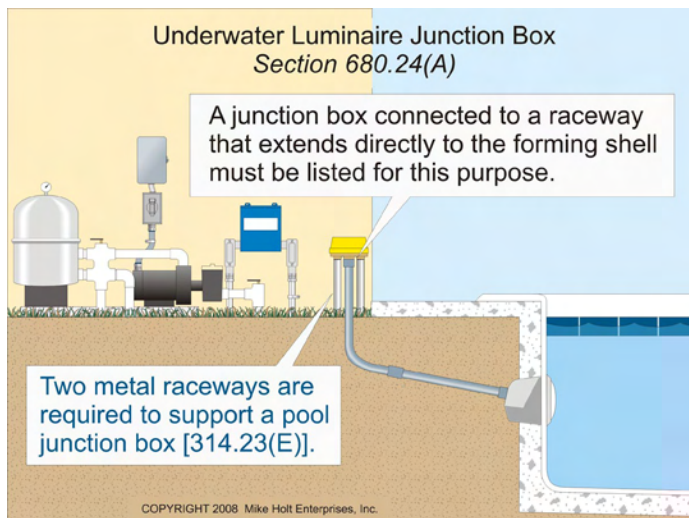

Figure 680-25

ming pool junction box and must be:

- (1) Equipped with threaded entries or a nonmetallic hub,
- (2) Constructed of copper, brass, or corrosion-resistant material approved by the authority having jurisdiction, and
- (3) Provide electrical continuity between metal raceways and grounding terminals within the junction box.

Author's Comment: In addition, the junction box must be provided with at least one more grounding terminal than the number of raceway entries [680.24(D)], and the junction box must have a strain relief for the cord [680.24(E)].

(2) Installation. Where the luminaire operates at over 15V, the junction box location must comply with (a) and (b). Where the luminaire operates at 15V or less, the junction box location must comply with (c).

(a) Vertical Spacing. The junction box must be located not less than 4 in. above the ground or permanently installed pool, outdoor spa, or outdoor hot tub deck, or not less than 8 in. above the maximum water level. **Figure 680-26**

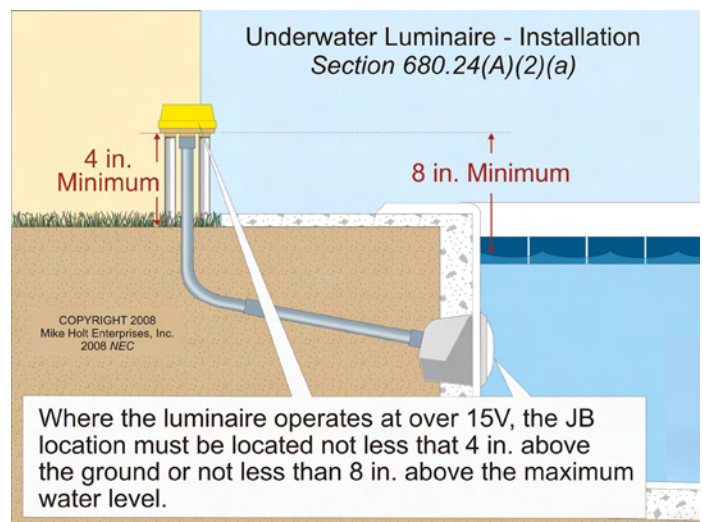

Figure 680-26

(b) Horizontal Spacing. The junction box must be located not less than 4 ft from the inside wall of the permanently installed pool, outdoor spa, or outdoor hot tub, unless separated by a solid fence, wall, or other permanent barrier.

Author's Comment: The junction box must be supported by two metal conduits threaded wrenchtight into the enclosure according to 314.23(E).

(c) Flush Deck Box. For a lighting system operating at 15 volts or less, a flush deck box is permitted if both of the following apply:

- (1) An approved potting compound prevents the entrance of moisture.
- (2) The flush deck box is located not less than 4 ft from the inside wall of the pool.

(B) Transformer or GFCI Enclosure. Where the enclosure for a transformer or GFCI is connected to a conduit that extends directly to an underwater permanently installed pool, outdoor spa, or outdoor hot tub luminaire forming shell, the enclosure must comply with the following:

(1) Construction. The enclosure must be listed and labeled for the purpose, and be:

- (1) Equipped with threaded entries or a nonmetallic hub,
- (2) Constructed of copper, brass, or corrosion-resistant material approved by the authority having jurisdiction, and
- (4) Provided with electrical continuity between all metal raceways and grounding terminals of the enclosure.

Author's Comment: See the definitions of "Labeled" and "Listed" in Article 100.

(C) Physical Protection. Junction boxes for underwater pool, spa, or hot tub luminaires must not be located in the walkway unless afforded protection by being located under diving boards or adjacent to fixed structures.

(D) Equipment Grounding Terminals. The junction box for an underwater permanently installed pool, outdoor spa, or outdoor hot tub luminaire must be provided with at least one more grounding terminal than the number of raceway entries.

Author's Comment: Typically, there are four grounding terminals in the junction box and three raceway entries.

(E) Strain Relief. The termination of a flexible cord that supplies an underwater permanently installed pool, outdoor spa, or outdoor hot tub luminaire must be provided with a strain relief device.

(F) Grounding. The metal parts and/or the circuit equipment grounding conductor terminals of a junction box, transformer enclosure, or other enclosure in the supply circuit to a wet-niche luminaire must be connected to the equipment grounding terminal of the supplied circuit panelboard.

Figure 680-27

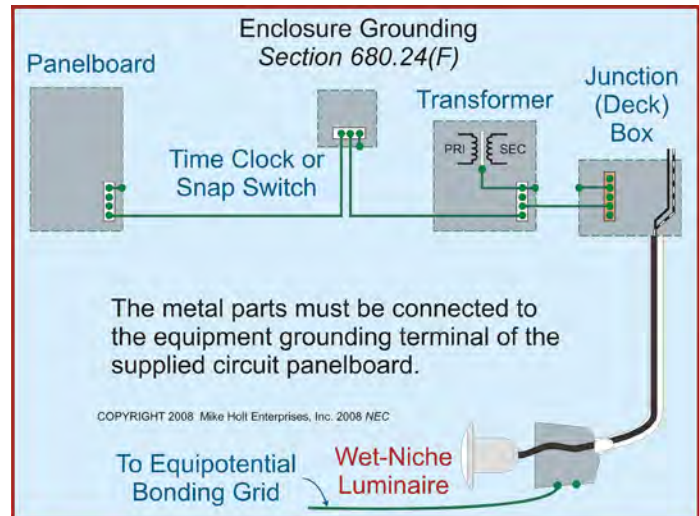

Figure 680-27

680.25 Feeders

(A) Wiring Methods. Feeder conductors to panelboards containing permanently installed pool, outdoor spa, or outdoor hot tub equipment circuits must be installed in rigid metal conduit, intermediate metal conduit, liquidtight flexible non-metallic conduit, or PVC conduit. Electrical metallic tubing is permitted where installed on or within a building, and electrical nonmetallic tubing is permitted where installed within a building.

Exception: Branch circuits for permanently installed pool, outdoor spa, or outdoor hot tub equipment can originate from an existing panelboard where the existing feeder contains an equipment grounding conductor within the outer sheath of a cable.

(B) Equipment Grounding Conductor. An insulated copper or aluminum equipment grounding conductor must be installed with the feeder conductors between the grounding terminal of the pool, outdoor spa, or outdoor hot tub equipment panelboard and the grounding terminal of the applicable service equipment.

(1) Size. This feeder equipment grounding conductor must be sized according to 250.122, but not smaller than 12 AWG.

(2) Separate Buildings. Where a feeder is run to a separate building or structure to supply permanently installed swimming pool, outdoor spa, or outdoor hot tub equipment, an insulated equipment grounding conductor must be installed with the feeder conductors to the disconnecting means at the separate building or structure [250.32(B)].

680.26 Equipotential Bonding.

(A) Performance. Equipotential bonding is intended to reduce voltage gradients in the area around a permanently installed pool, outdoor spa, or outdoor hot tub by the use of a common bonding grid in accordance with 680.26(B) and (C).

(B) Bonded Parts. The parts of a permanently installed pool, outdoor spa, or outdoor hot tub listed in (B)(1) through (B)(7) must be bonded together with a solid copper conductor not smaller than 8 AWG with listed pressure connectors, terminal bars, exothermic welding, or other listed means [250.8(A)]. **Figure 680–28**

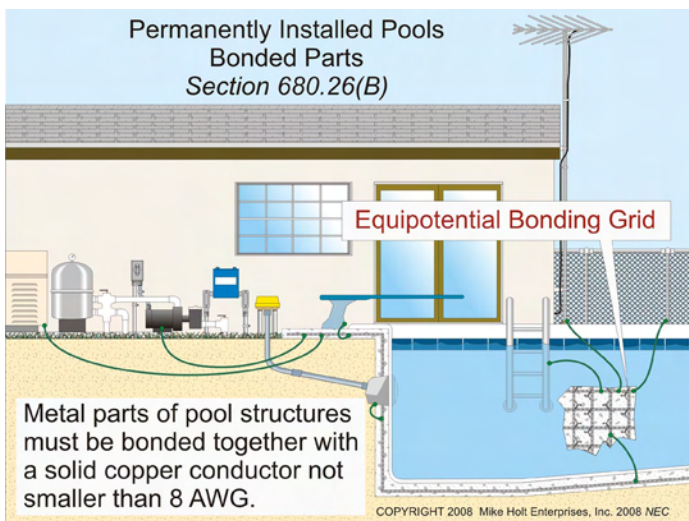

Figure 680–28

Equipotential bonding is not required to extend to or be attached to any panelboard, service equipment, or grounding electrode.

(1) Concrete Pool, Outdoor Spa, and Outdoor Hot Tub Shells.

(a) Structural Reinforcing Steel. Unencapsulated structural reinforcing steel in concrete shells secured together by steel tie wires. **Figure 680–29**

(2) Perimeter Surfaces. An equipotential bonding grid must extend 3 ft horizontally beyond the inside walls of a pool, outdoor spa, or outdoor hot tub, including unpaved, paved, and poured concrete surfaces. **Figure 680–30**

The bonding grid must comply with (a) or (b) and be attached to the conductive pool reinforcing steel at a minimum of four points uniformly spaced around the perimeter of the walls of a pool, outdoor spa, or outdoor hot tub.

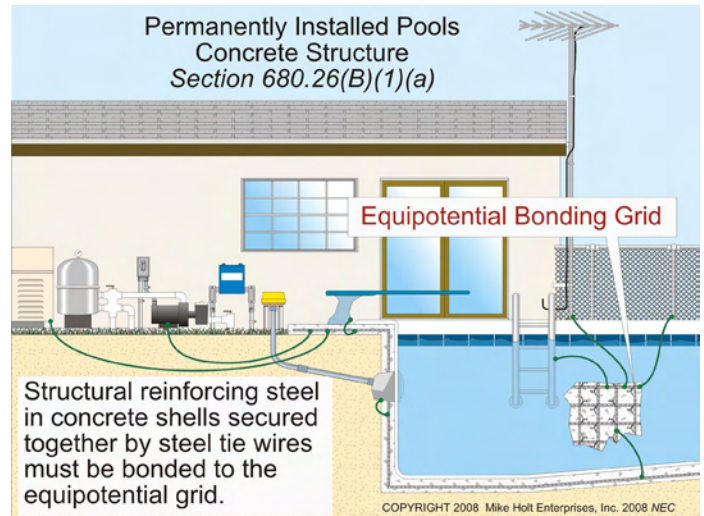

Figure 680–29

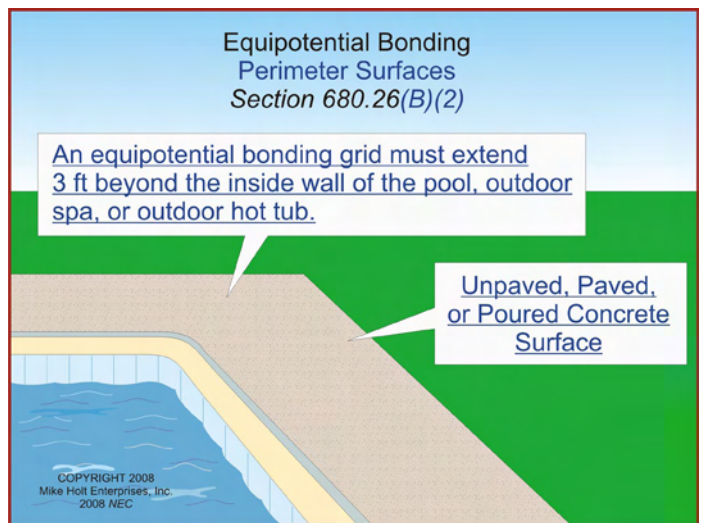

Figure 680–30

(a) Structural Reinforcing Steel. Unencapsulated structural reinforcing steel in concrete shells secured together by steel tie wires [680.26(B)(1)(a)]. **Figure 680–31**

Author's Comment: The 2008 *NEC* doesn't provide any guidance on the installation requirements for structural reinforcing steel when used as a perimeter equipotential bonding grid.

(b) Alternate Means. Equipotential bonding conductor meeting all of the following requirements: **Figure 680–32**

- (1) 8 AWG bare solid copper bonding conductor.

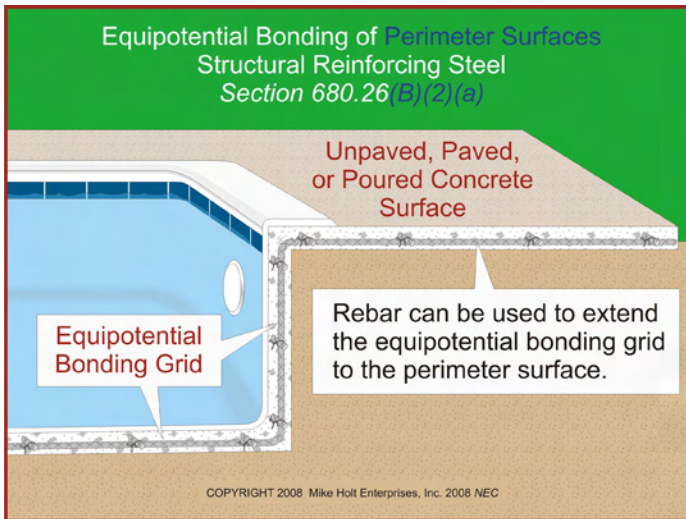

Figure 680-31

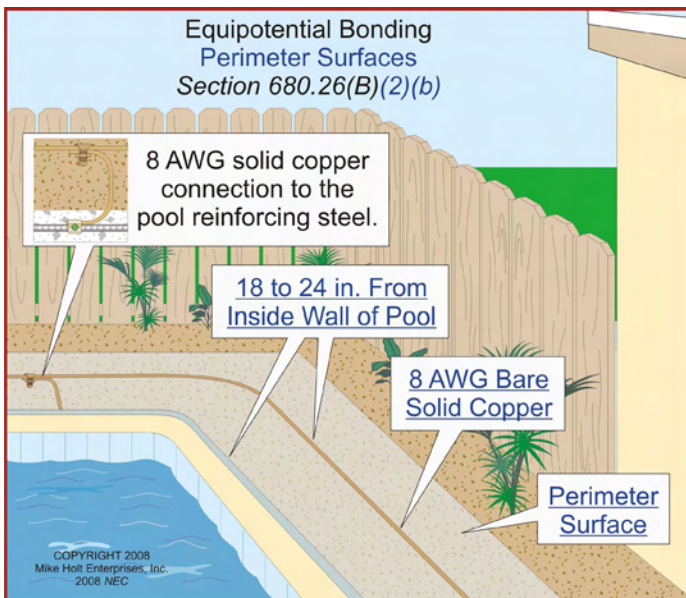

Figure 680-32

- (2) The bonding conductor must follow the contour of the perimeter surface.
- (3) Listed splicing devices.
- (4) Bonding conductor must be 18 to 24 in. from the inside walls of the pool.
- (5) Bonding conductor must be secured within or under the perimeter surface 4 to 6 in. below the subgrade.

(3) **Metallic Components.** Metallic parts of the pool, outdoor spa, or outdoor hot tub structure must be bonded to the equipotential grid.

(4) **Underwater Metal Forming Shells.** Metal forming shells and mounting brackets for luminaires and speakers must be bonded to the equipotential grid.

(5) **Metal Fittings.** Metal fittings sized 4 in. and larger that penetrate into the pool, outdoor spa, or outdoor hot tub structure, such as ladders and handrails must be bonded to the equipotential grid.

(6) **Electrical Equipment.** Metal parts of electrical equipment associated with the pool, outdoor spa, or outdoor hot tub water circulating system, such as water heaters and pump motors and metal parts of pool covers must be bonded to the equipotential grid. **Figure 680-33**

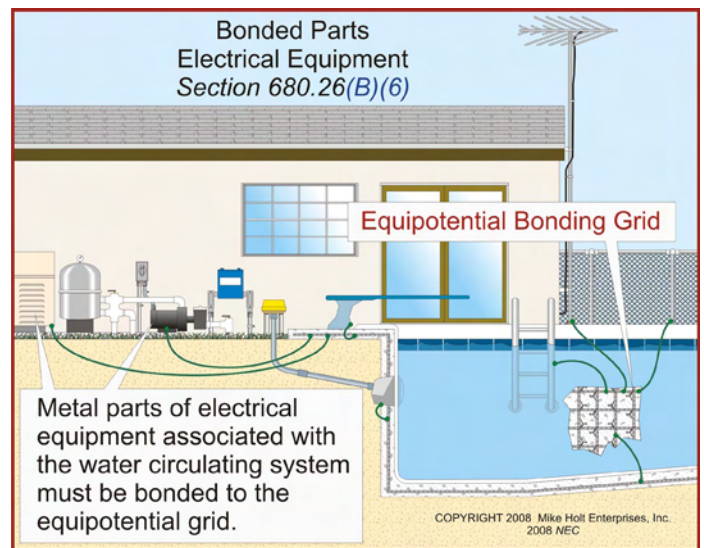

Figure 680-33

Exception: Metal parts of listed equipment incorporating an approved system of double insulation are not required to be bonded to the equipotential grid.

(a) **Double-Insulated Water Pump Motors.** Where a double-insulated water pump motor is installed, a solid 8 AWG copper conductor from the bonding grid must be provided for a replacement motor.

(b) **Pool Water Heaters.** Pool water heaters must be grounded and bonded in accordance with equipment instructions.

(7) **Metal Wiring Methods and Equipment.** Metal-sheathed cables and raceways, metal piping, and all fixed metal parts must be bonded to the equipotential grid.

Exception No. 1: Where separated from the pool, outdoor spa, or outdoor hot tub structure by a permanent barrier.

Exception No. 2: Where located more than 5 ft horizontally of the inside walls of the pool, outdoor spa, or outdoor hot tub structure.

Exception No. 3: Where located more than 12 ft measured vertically above the maximum water level.

(C) Pool Water. A minimum conductive surface area of 9 sq in. must be installed in contact with the pool, outdoor spa, or outdoor hot tub structure water. This water bond is permitted to consist of metal parts that are required to be bonded in 680.26(B). **Figure 680–34**

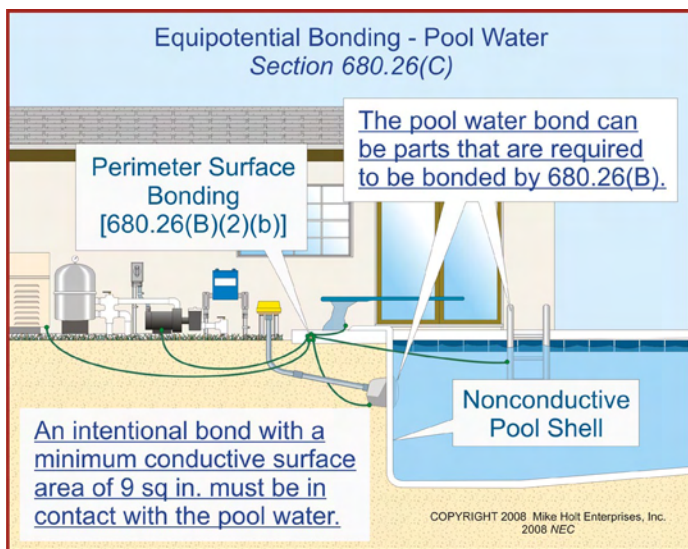

Figure 680–34

680.27 Specialized Equipment.

(B) Electrically Operated Covers.

(1) Motors and Controllers. The electric motors, controllers, and wiring for an electrically operated cover must be located not less than 5 ft from the inside wall of a permanently installed pool, outdoor spa, or outdoor hot tub, unless separated by a permanent barrier.

(2) Wiring Methods. The electric motor and controller circuit must be GFCI protected.

PART III. STORABLE SWIMMING POOLS

680.30 General. Electrical installations for storable pools must also comply with Part I of Article 680.

Author's Comment: The requirements contained in Part I of Article 680 include the locations of switches, receptacles, and luminaires.

680.31 Pumps. Cord-connected pool pumps must be double insulated and have a means to ground the internal metal parts to an equipment grounding conductor run with the power-supply conductors in the flexible cord. The cord must also have GFCI protection as an integral part of the attachment plug. **Figure 680–35**

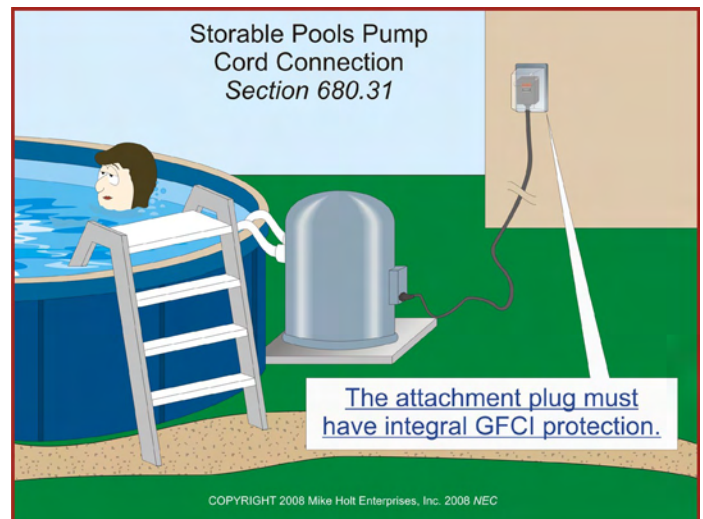

Figure 680–35

680.32 GFCI-Protected Receptacles. GFCI protection is required for electrical equipment used with storable pools. **Figure 680–36**

The measured distance is the shortest path a supply cord connected to the receptacle would follow without piercing a floor, wall, ceiling, doorway with hinged or sliding door, window opening, or other effective permanent barrier.

Author's Comment: This requirement mirrors the requirements contained in 680.25(A)(5) and (6) for permanently installed pools.



Figure 680-36

680.34 Receptacle Locations. Receptacles must not be located less than 6 ft from the inside walls of a storable pool. The receptacle distance is measured as the shortest path an appliance cord would follow without passing through a wall, doorway, or window. **Figure 680-37**

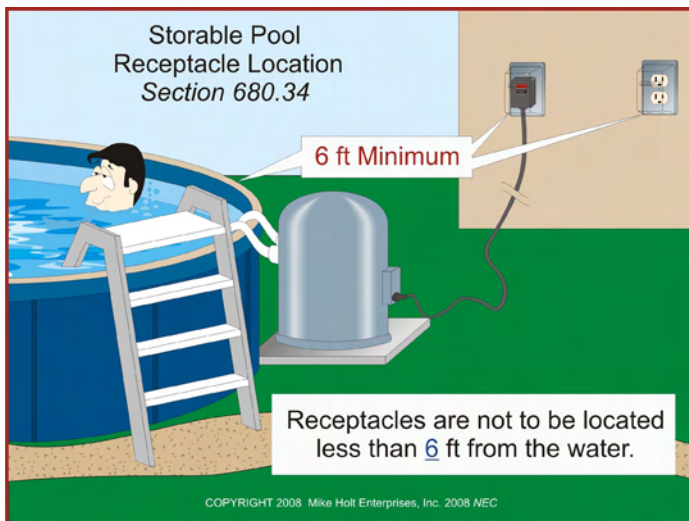

Figure 680-37

PART IV. SPAS AND HOT TUBS

680.40 General. Electrical installations for spas and hot tubs must comply with Part I as well.

680.41 Emergency Switch for Spas and Hot Tubs. In other than a single-family dwelling, a clearly labeled emergency spa or hot tub water recirculation and jet system shutoff must be supplied. The emergency shutoff must be readily accessible to the users and located not less than 5 ft away, but adjacent to and within sight of the spa or hot tub.

Figure 680-38

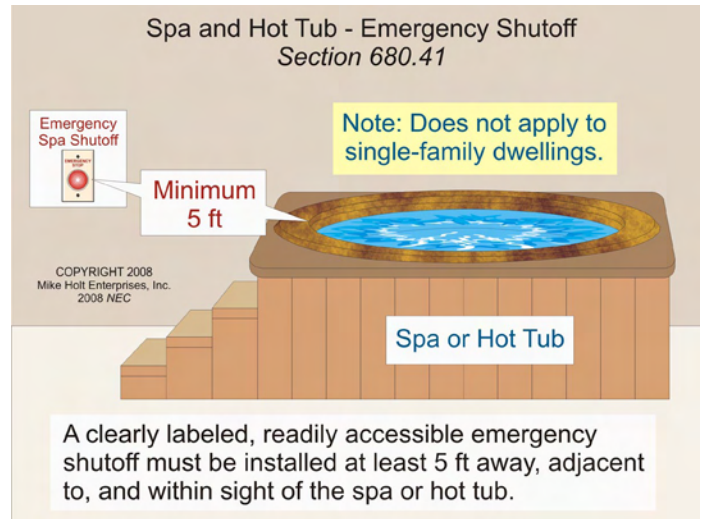

Figure 680-38

Author's Comments:

- Either the maintenance disconnecting means required by 680.12 or a pushbutton that controls a relay located in accordance with this section can be used to meet the emergency shutoff requirement.
- The purpose of the emergency shutoff is to protect users. Deaths and injuries have occurred in less than 3 ft of water because individuals became stuck to the water intake opening. This requirement applies to spas and hot tubs installed indoors as well as outdoors.

680.42 Outdoor Installations. Electrical installations for outdoor spas or hot tubs must comply with Parts I and II of this article, except as permitted for (B) or (C).

(B) Bonding. Bonding is permitted by mounting equipment to a metal frame or base. Metal bands that secure wooden staves aren't required to be bonded.

(C) Interior Wiring for Outdoor Spas or Hot Tubs. Any Chapter 3 wiring method containing a copper equipment grounding conductor insulated or enclosed within the outer sheath of the wiring method and not smaller than 12 AWG is permitted in the interior of a one-family dwelling for the connection to motor, heating, and control loads that are part of a self-contained spa or hot tub, or a packaged spa or hot tub equipment assembly.

Wiring to an underwater light must comply with 680.23 or 680.33.

680.43 Indoor Installations. Electrical installations for an indoor spa or hot tub must comply with Parts I and II of Article 680, except as modified by this section. Indoor installations of spas or hot tubs can be connected by any of the wiring methods contained in Chapter 3.

Exception: Listed packaged units rated 20A or less can be cord-and-plug-connected.

(A) Receptacles. At least one 15A or 20A, 125V receptacle must be located at least 6 ft, but not more than 10 ft, from the inside wall of the spa or hot tub. **Figure 680–39**

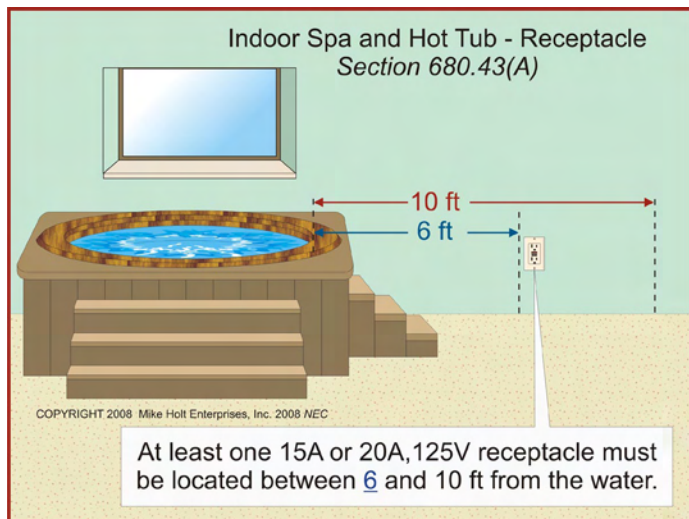

Figure 680–39

(1) Location. Other receptacles must be located not less than 6 ft, measured horizontally, from the inside walls of the indoor spa or hot tub.

(2) GFCI-Protected Receptacles. Receptacles rated 30A or less at 125V, located within 10 ft of the inside walls of an indoor spa or hot tub, must be GFCI protected. **Figure 680–40**

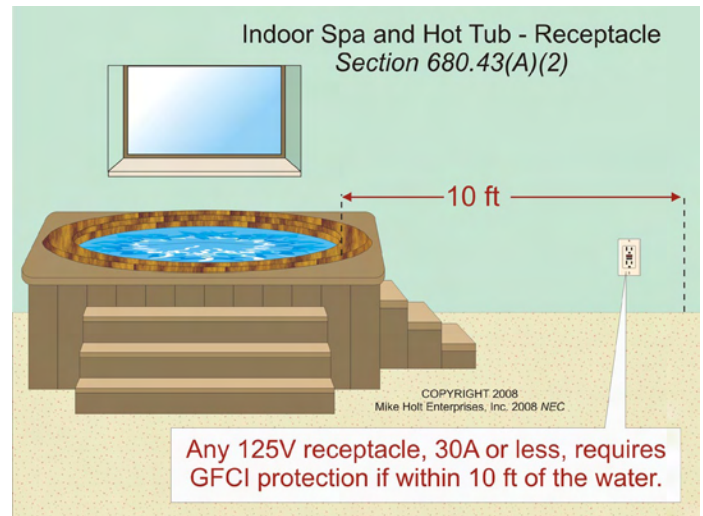

Figure 680–40

(3) Spa or Hot Tub Receptacle. Receptacles that provide power for an indoor spa or hot tub must be GFCI protected.

(4) Measurements. In determining the above dimensions, the distance to be measured must be the shortest path that the supply cord of an appliance connected to the receptacle would follow without piercing a floor, wall, ceiling, doorway with hinged or sliding door, window opening, or other effective permanent barrier.

(B) Luminaires and Ceiling Fans.

(1) Elevation. Luminaires and ceiling fans within 5 ft, measured horizontally, from the inside walls of the indoor spa or hot tub must be:

- (a) Not less than 12 ft above an indoor spa or hot tub where no GFCI protection is provided.
- (b) Not less than 7½ ft above an indoor spa or hot tub where GFCI protection is provided.
- (c) Luminaires and ceiling fans can be mounted less than 7½ ft above an indoor spa or hot tub, if GFCI protection is provided and the installation meets either of the following requirements:

- (1) Recessed luminaires with a glass or plastic lens, nonmetallic or electrically isolated metal trim, and suitable for use in damp locations.

Author's Comment: See the definition of "Location, Damp" in Article 100.

(2) Surface-mounted luminaires with a glass or plastic globe, a nonmetallic body, or a metallic body isolated from contact, and suitable for use in damp locations.

(C) Switches. Switches must be located not less than 5 ft, measured horizontally, from the inside walls of the indoor spa or hot tub. **Figure 680–41**

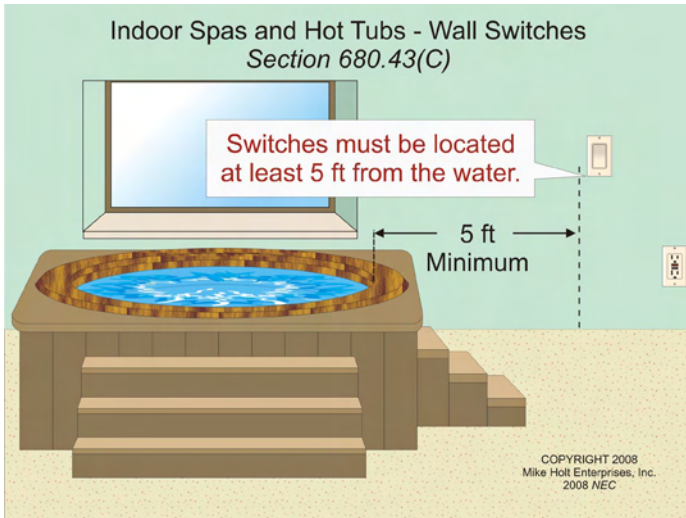

Figure 680–41

(D) Bonding. The following parts of an indoor spa or hot tub must be bonded together:

- (1) Metal fittings within or attached to the indoor spa or hot tub structure.
- (2) Metal parts of electrical equipment associated with the indoor spa or hot tub water circulating system.
- (3) Metal raceways and metal piping within 5 ft of the inside walls of the indoor spa or hot tub, and not separated from the indoor spa or hot tub by a permanent barrier.
- (4) Metal surfaces within 5 ft of the inside walls of an indoor spa or hot tub not separated from the indoor spa or hot tub area by a permanent barrier.

Exception No. 1: Nonelectrical equipment, such as towel bars or mirror frames, which aren't connected to metallic piping, aren't required to be bonded.

Exception No. 2: Metal parts of a listed self-contained spa or hot tub.

(E) Methods of Bonding. Metal parts associated with the spa or hot tub as described in 680.43(D) must be bonded by any of the following methods:

- (1) Threaded metal piping and fittings
- (2) Metal-to-metal mounting to a common frame or base
- (3) A solid copper conductor not smaller than 8 AWG

680.44 GFCI Protection. The outlet that supplies a self-contained indoor spa or hot tub, a packaged spa or hot tub equipment assembly, or a field-assembled spa or hot tub must be GFCI protected. Because this rule applies to all outlets and not just receptacle outlets, a hard-wired indoor spa or hot tub would require GFCI protection. See the definition of “Outlet” in Article 100. **Figure 680–42**



Figure 680–42

Author's Comment: A self-contained spa or hot tub is a factory-fabricated unit that consists of a spa or hot tub vessel with all water-circulating, heating, and control equipment integral to the unit. A packaged spa or hot tub equipment assembly is a factory-fabricated unit that consists of water circulating, heating, and control equipment mounted on a common base intended to operate a spa or hot tub [680.2].

(A) Listed Units. Additional GFCI protection isn't required for a listed self-contained spa or hot tub unit or listed packaged spa or hot tub assembly marked to indicate that integral GFCI protection has been provided for electrical parts within the unit or assembly. **Figure 680–43**



Figure 680-43

(B) Other Units. GFCI protection isn't required for a field-assembled spa or hot tub rated three-phase or that has a voltage rating over 250V, or has a heater load above 50A.

(C) Combination Pool and Spa or Hot Tub. GFCI protection isn't required for equipment that supplies a combination pool/hot tub or spa assembly.

PART V. FOUNTAINS

680.50 General. The general installation requirements contained in Part I apply to fountains. In addition, fountains that have water common to a permanently installed pool must comply with Part I and Part II of this article.

Author's Comment: Fountain. An ornamental, display, or reflection pool [680.2].

680.51 Luminaires, Submersible Pumps, and Other Submersible Equipment.

(A) GFCI Protection for Fountain Equipment. The branch circuit that supplies luminaires, submersible pumps, and other submersible equipment must be GFCI protected, unless the equipment is listed for not more than 15V and is supplied by a listed pool transformer that complies with 680.23(A)(2).

(C) Luminaire Lenses. Luminaires must be installed so the top of the luminaire lens is below the normal water level unless listed for above-water use. **Figure 680-44**

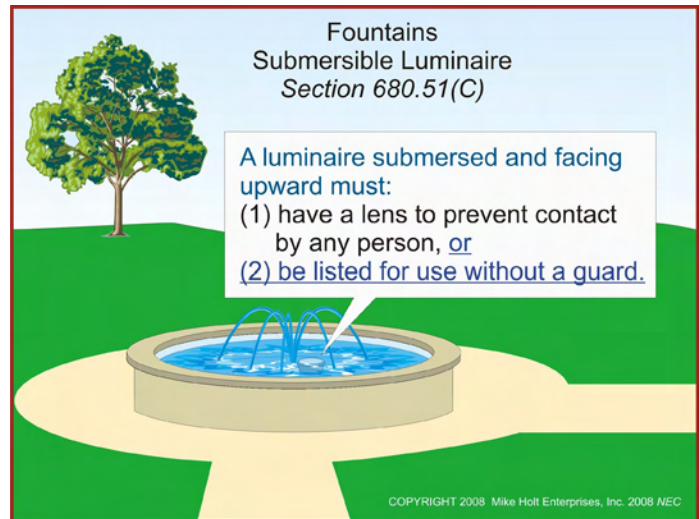

Figure 680-44

(E) Cords. The maximum length of each exposed cord in the fountain is 10 ft. Power-supply cords that extend beyond the fountain perimeter must be enclosed in a wiring enclosure approved by the authority having jurisdiction.

(F) Servicing. Equipment must be capable of being removed from the water for relamping or for normal maintenance.

(G) Stability. Equipment must be inherently stable or securely fastened in place.

680.53 Bonding. Metal piping systems associated with the fountain must be bonded to the circuit equipment grounding conductor of the branch circuit that supplies the fountain equipment.

680.55 Methods of Equipment Grounding.

(B) Supplied by a Flexible Cord. Equipment supplied by a flexible cord must have all exposed metal parts connected to an insulated copper equipment grounding conductor that is an integral part of the cord.

680.56 Cord-and-Plug-Connected Equipment.

(A) GFCI Protection of Cord-and-Plug Equipment. Cord-and-plug-connected fountain equipment must be GFCI protected.

(B) Cord Type. Flexible cords immersed in or exposed to water must be of the hard-service type, as designated in Table 400.4, and must be marked "Water-Resistant."

680.57 Signs in or Adjacent to Fountains.

(B) GFCI Protection of Sign Equipment. Each circuit that supplies a sign installed within a fountain, or within 10 ft of the fountain edge, must be GFCI protected [680.57(A)].

Figure 680-45

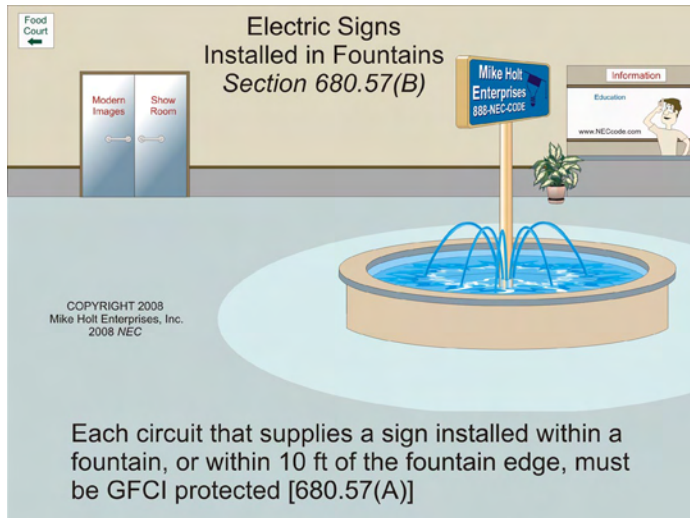

Figure 680-45

680.58 GFCI-Protected Receptacles. GFCI protection is required for all 15A and 20A, 125V through 250V receptacles located within 20 ft of the inside walls of a fountain.

Figure 680-46

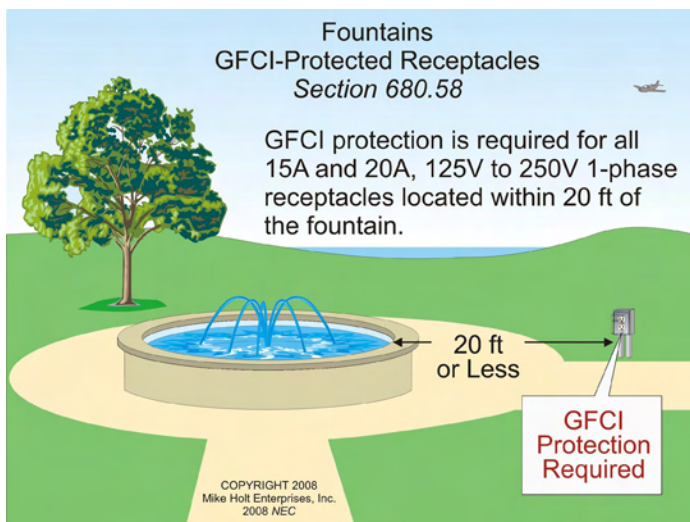

Figure 680-46

PART VII. HYDROMASSAGE BATHTUBS

680.70 General. A hydromassage bathtub is only required to comply with the requirements of Part VII; it's not required to comply with the other parts of this article.

Author's Comment: Hydromassage Bathtub. A permanently installed bathtub with a recirculating piping system designed to accept, circulate, and discharge water after each use [680.2].

680.71 GFCI Protection. Hydromassage bathtubs and their associated electrical components must be on an individual branch circuit protected by a readily accessible GFCI. In addition, GFCI protection is required for all receptacles rated 30A or less at 125V located within 6 ft of the inside walls of a hydromassage bathtub. **Figure 680-47**

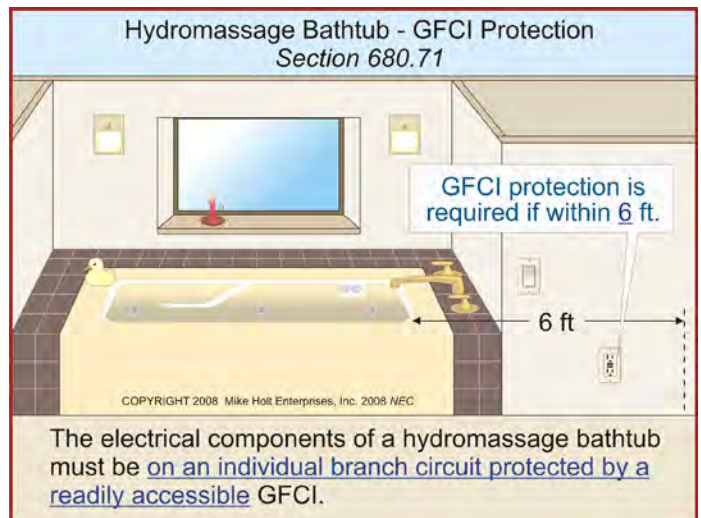

Figure 680-47

Author's Comment: The circuit for a hydromassage bathtub must be installed in accordance with the manufacturer's instructions included in the listing and labeling, which will typically include amperage requirements and may require separate circuits for the pump and heater [110.3(B)].

680.72 Other Electrical Equipment. Luminaires, switches, receptacles, and other electrical equipment located in the same room and not directly associated with a hydromassage bathtub must be installed in accordance with Chapters 1 through 4.

Author's Comment: A hydromassage bathtub is treated like a regular bathtub. For example, a 5 ft clearance isn't required for switches or receptacles, and the fixtures must be installed in accordance with 410.4(D). **Figure 680-48**



Figure 680-48

680.73 Accessibility. Electrical equipment for hydromassage bathtubs must be capable of being removed or exposed without damaging the building structure or finish.

680.74 Equipotential Bonding. If the building contains a metal piping system, it must be bonded, with a solid copper conductor not smaller than 8 AWG, to the circulating pump if it's not double insulated.

The equipotential hydromassage bonding jumper is not required to be bonded to any remote panelboard, service equipment, or electrode. **Figure 680-49**

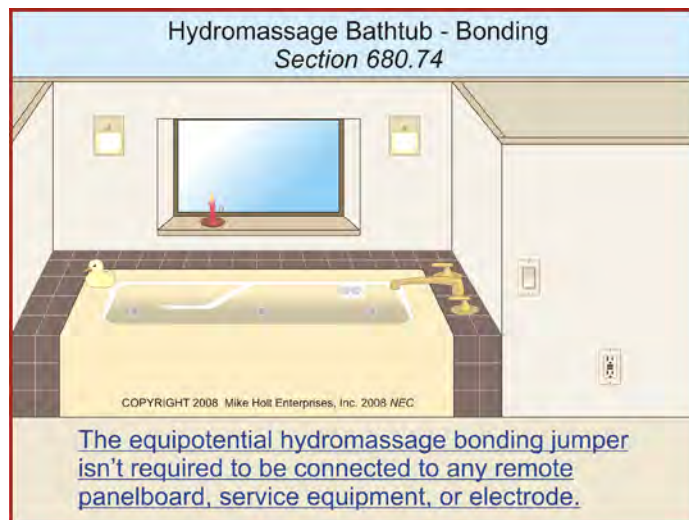

Figure 680-49

Practice Questions

ARTICLE 680. SWIMMING POOLS, SPAS, HOT TUBS, FOUNTAINS, AND SIMILAR INSTALLATIONS—PRACTICE QUESTIONS

1. A spa or hot tub is a hydromassage pool or tub and is not designed to have the contents drained or discharged after each use.
 - (a) True
 - (b) False
2. Insulated overhead utility service conductors that are cabled together with a bare messenger and operate at not over 750 volts-to-ground shall maintain a _____ clearance in any direction to the water level.
 - (a) 14 ft
 - (b) 16 ft
 - (c) 20 ft
 - (d) 22½ ft
3. All electric pool water heaters shall have the heating elements not exceed _____.
 - (a) 20A
 - (b) 35A
 - (c) 48A
 - (d) 60A
4. Electric swimming pool equipment can be installed in pits where drainage adequately prevents water accumulation during abnormal operation.
 - (a) True
 - (b) False
5. Grounding-type GFCI-protected receptacles of the single and locking type for motors related to the circulation and sanitation system of a pool can be located not less than _____ from the inside walls of the pool.
 - (a) 3 ft
 - (b) 6 ft
 - (c) 8 ft
 - (d) 12 ft
6. Circuits rated 15A or 20A, 125V or 250V supplying pool pump motors for a permanently installed pool shall be _____ whether the pump is cord-and-plug-connected or direct connected.
 - (a) AFCI protected
 - (b) GFCI protected
 - (c) a or b
 - (d) a and b
7. A pool transformer used for the supply of underwater luminaires, together with the transformer enclosure, shall _____.
 - (a) be of the isolated-winding type with an ungrounded secondary
 - (b) have a grounded metal barrier between the primary and secondary windings
 - (c) be listed for the purpose
 - (d) all of these
8. When PVC conduit extends from the pool light forming shell to a pool junction box, an 8 AWG _____ conductor shall be installed in the raceway.
 - (a) solid bare
 - (b) solid insulated
 - (c) stranded insulated
 - (d) b or c
9. EMT where installed on buildings, is permitted to contain branch-circuit wiring for underwater pool luminaires.
 - (a) True
 - (b) False
10. The junction box connected to a conduit that extends to the forming shell of the luminaire that operates at over 15V shall be located not less than _____ above the ground level or pool deck.
 - (a) 4 in.
 - (b) 6 in.
 - (c) 8 in.
 - (d) 12 in.

11. The enclosure for a transformer or ground-fault circuit interrupter connected to a conduit that extends directly to a pool light forming shell shall be _____ for this purpose.
- (a) labeled
 - (b) listed
 - (c) approved
 - (d) a and b
12. The feeder to a swimming pool panelboard at a separate building or structure can be supplied with any Chapter 3 wiring method provided the feeder has a separate insulated copper equipment grounding conductor.
- (a) True
 - (b) False
13. The pool structure, including the reinforcing metal of the pool shell and deck, shall be bonded together.
- (a) True
 - (b) False
14. The electric motors, controllers, and wiring for an electrically operated pool cover shall be _____.
- (a) located at least 5 ft from the inside wall of the pool
 - (b) separated from the pool by a permanent barrier
 - (c) a and b
 - (d) a or b
15. Electric equipment, including power-supply cords, used with storable pools shall be _____.
- (a) AFCI protected
 - (b) GFCI protected
 - (c) a or b
 - (d) none of these
16. Listed packaged spa or hot tub equipment assemblies, or self-contained spas or hot tubs installed outdoors, are permitted to have flexible connections using _____.
- (a) LFMC or LFNC in lengths of not more than 6 ft
 - (b) cords not longer than 15 ft, where GFCI protected
 - (c) a or b
 - (d) none of these
17. Receptacles rated 30A or less, 125V within 10 ft of the inside walls of an indoor spa or hot tub, shall be _____.
- (a) GFCI protected
 - (b) AFCI protected
 - (c) a or b
 - (d) none of these
18. Surface-mounted luminaires _____ located over or within 5 ft, measured horizontally, from the inside walls of an indoor spa or hot tub can be installed at less than 7 ft 6 in. above the maximum water level when GFCI protected.
- (a) with a glass or plastic globe
 - (b) with a nonmetallic body or a metallic body isolated from contact
 - (c) suitable for use in a damp location
 - (d) all of these
19. Metal raceways and metal piping within _____ of the inside walls of an indoor spa or hot tub, and not separated from the indoor spa or hot tub by a permanent barrier, shall be bonded.
- (a) 4 ft
 - (b) 5 ft
 - (c) 7 ft
 - (d) 12 ft
20. The branch circuit supplying submersible fountain equipment shall be _____, unless the equipment is listed for operation at not more than 15V.
- (a) 240V
 - (b) GFCI protected
 - (c) a and b
 - (d) none of these
21. Metal piping systems associated with a fountain shall be bonded to the equipment grounding conductor of the _____.
- (a) branch circuit supplying the fountain
 - (b) bonding grid
 - (c) equipotential plane
 - (d) grounding electrode system
22. Flexible cords immersed in or exposed to water in a fountain shall be _____.
- (a) extra-hard usage type
 - (b) listed with a “W” suffix
 - (c) encased in not less than 2 in. of concrete
 - (d) a and b

23. All 15A and 20A, single-phase, 125V through 250V receptacles located within _____ of a fountain edge shall have GFCI protection.
- (a) 8 ft
 - (b) 10 ft
 - (c) 15 ft
 - (d) 20 ft
24. Hydromassage bathtub electrical equipment shall be _____ without damaging the building structure or building finish.
- (a) readily accessible
 - (b) accessible
 - (c) within sight
 - (d) none of these

ARTICLE

680

Answer Key

1. (a) 680.2, Spa or Hot Tub
2. (d) 680.8 Table
3. (c) 680.9
4. (a) 680.11
5. (b) 680.22(A)(1)
6. (b) 680.22(B)
7. (d) 680.23(A)(2)
8. (d) 680.23(B)(2)(b)
9. (a) 680.23(F)(1)
10. (a) 680.24(A)(2)(a)
11. (d) 680.24(B)(1)
12. (b) 680.25(A)
13. (a) 680.26(B)(1)
14. (d) 680.27(B)(1)
15. (b) 680.32
16. (c) 680.42(A)(1) and (2)
17. (a) 680.43(A)(2)
18. (d) 680.43(B)(1)(c)(2)
19. (b) 680.43(D)(3)
20. (b) 680.51(A)
21. (a) 680.53
22. (d) 680.56(B)
23. (d) 680.58
24. (b) 680.73