

**90 MPH
EXPOSURE B**

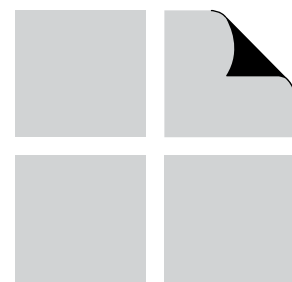

GUIDE

WFCM

WOOD | FRAME | CONSTRUCTION | MANUAL

**GUIDE TO WOOD CONSTRUCTION
IN HIGH WIND AREAS
FOR ONE- AND TWO-FAMILY DWELLINGS**



A F & P A[®]



**American Forest & Paper Association
American Wood Council**

**In Cooperation with the
International Code Council[®]**



May 2013

Codes and Standards Addenda and Amendments Related to Design Value Changes

The American Lumber Standard Committee (ALSC) Board of Review has approved changes to design values for all grades and all sizes of visually-graded Southern Pine and Mixed Southern Pine lumber, 2"- 4" thick, with a recommended effective date of June 1, 2013. For more information, visit www.spib.org and www.southernpine.com.

AWC has developed [addenda and other updates](#) to use with new construction designed in accordance with many of its standards and design tools. However, this document has not been updated to account for changes to design values. Designers are urged to download the addendum to the [2001 WFCM](#), which contains revised tables based on the new design values, and use them accordingly with this document.

For additional information or questions, visit the AWC website at www.awc.org or email your request to info@awc.org.

Thank you.

Updates and Errata

While every precaution has been taken to ensure the accuracy of this document, errors may have occurred during development.

Updates or Errata for the WFCM Guide are posted to the American Wood Council website at www.awc.org. Technical inquiries may be addressed to awcinfo@afandpa.org.

**90 MPH
EXPOSURE B**

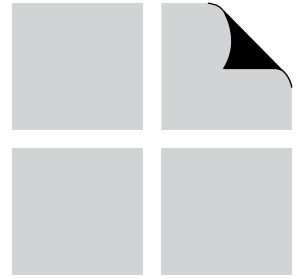

GUIDE

WFCM

WOOD FRAME CONSTRUCTION MANUAL

**GUIDE TO WOOD CONSTRUCTION
IN HIGH WIND AREAS
FOR ONE- AND TWO-FAMILY DWELLINGS**

**Guide to Wood Construction in High Wind Areas for One- and Two-Family Dwellings –
90 mph Exposure B Wind Zone, 2006 Edition**

First Printing: October 2006

ISBN 0-9786245-4-8

Copyright © 2006 by American Forest & Paper Association, Inc.

All rights reserved. No part of this publication may be reproduced, distributed, or transmitted in any form or by any means, including, without limitation, electronic, optical, or mechanical means (by way of example and not limitation, photocopying, or recording by or in an information storage retrieval system) without express written permission of the American Forest & Paper Association, Inc. For information on permission to copy material, please contact:

Copyright Permission
AF&PA American Wood Council
1111 Nineteenth St., NW, Suite 800
Washington, DC 20036
email: awcinfo@afandpa.org

Printed in the United States of America

Table of Contents

INTRODUCTION	1
1 GENERAL PROVISIONS	3
1.1 SCOPE	3
Design Concepts.....	3
1.2 APPLICABILITY	5
Building Height.....	5
Building Dimension.....	5
Building Shape.....	5
1.3 FRAMING CONNECTIONS	6
2 FOUNDATION ANCHORAGE	8
2.1 GENERAL LOADS	8
2.2 ANCHOR BOLTS	8
2.3 ANCHORAGE AT OPENINGS	9
3 FLOORS	10
3.1 GENERAL	10
3.2 WOOD FLOOR JOIST SYSTEMS	10
3.3 WOOD I-JOISTS FLOOR SYSTEMS	11
3.4 WOOD FLOOR TRUSS SYSTEMS	11
3.5 FLOOR SHEATHING	11
3.6 FLOOR BRACING	11
4 WALLS	12
4.1 GENERAL	12
4.2 EXTERIOR WALLS	12
4.3 EXTERIOR WALL SHEATHING	17
5 ROOFS	20
5.1 GENERAL	20
5.2 WOOD RAFTER SYSTEMS	20
5.3 WOOD I-JOIST ROOF SYSTEMS	23
5.4 WOOD ROOF TRUSS SYSTEMS	23
5.5 ROOF SHEATHING	23
5.6 ROOF BRACING ENDWALL	23
GLOSSARY OF TERMS	24
CHECKLIST	27

TABLES

Table 1.	Maximum Building Lengths for Permitted Building Aspect Ratios	6
Table 2.	General Nailing Schedule	7
Table 3.	Foundation Anchorage Loads	8
Table 4.	Anchor Bolt Spacing	8
Table 5.	Exterior Wall - Wood Studs	12
Table 6.	Top Plate Splice	13
Table 7.	Wall Connections at Loadbearing Walls	14
Table 8.	Wall Connections for Endwall Assemblies	15
Table 9.	Wall Openings – Headers in Loadbearing and Non-Loadbearing Walls	16-17
Table 10.	Percentage of Full-Height Sheathing in Minimum Building Dimension (W)	18
Table 11.	Percentage of Full-Height Sheathing in Maximum Building Dimension (L)	19
Table 12.	Truss, I-Joist, or Rafter Connections at Loadbearing Walls	21
Table 13.	Ridge Strap Connections	22
Table 14.	Outlooker Connections at Gravity Non-Loadbearing Walls	23

FIGURES

Figure 1.	Master Building Frame	4
Figure 2.	Mean Roof Height (MRH)	5
Figure 3.	Inscribed Building Dimensions	5
Figure 4.	Building Aspect Ratios	6
Figure 5.	Anchor Bolts Resisting Uplift, Lateral, and Shear Loads	9
Figure 6.	Floor Diaphragm Opening Limits	10
Figure 7.	Setback Limits for Loadbearing Wall or Shear Wall and Limit on Loadbearing Wall Offset from Support	10
Figure 8.	Cantilever with Loadbearing Wall or Shear Wall	11
Figure 9.	Floor Bracing	11
Figure 10.	Maximum Wall Height and Stud Spacing	12
Figure 11.	Ceiling Bracing Gable Endwall	13
Figure 12.	Top Plate Intersection Detail	13
Figure 13.	Top Plate Splice Length	13
Figure 14.	Story-To-Story Uplift and Lateral Connections	14
Figure 15.	Full-Height Gable Endwall Stud	15
Figure 16.	Rake Truss	15
Figure 17.	Studs and Headers Around Wall Openings	16
Figure 18a.	Corner Stud Hold Down Detail – 3 Studs With Blocking	18
Figure 18b.	Corner Stud Hold Down Detail – 4 Studs	19
Figure 19.	Roof Systems	20
Figure 20.	Rafter Outlooker Details	22

Introduction

The purpose of this *Guide to Wood Construction in High Wind Areas: 90 MPH Exposure B Wind Zone (Guide)* is to simplify the construction and design of wood frame buildings in areas where design wind velocity requirements do not exceed 90 miles per hour Exposure Category B. This Guide is in compliance with the building code-referenced ANSI/AF&PA 2001 *Wood Frame Construction Manual (WFCM) for One- and Two-Family Dwellings*. Accordingly, any designs in compliance with this Guide should also be in full compliance with the *WFCM*. The provisions of this Guide focus on ensuring structural integrity for resisting wind loads. This Guide does not specifically address other loading conditions such as those created by live, seismic (earthquake), snow, or flood loads. These additional loading conditions must be considered as required by the building code and are addressed in the *WFCM*.

The information in this Guide offers information to architects, builders, designers, code officials, instructors and others interested in simplified design. It is not the intent of this Guide to instruct on all aspects or techniques of proper framing or design. In developing the provisions of this Guide using provisions of the *WFCM*, the most reliable data available from laboratory tests and experience with structures in service have been carefully analyzed and evaluated for the purpose of providing a consistent standard of practice. It is intended that this document be used in conjunction with competent engineering design, accurate fabrication, and adequate supervision of construction. Therefore, AF&PA does not assume any responsibility for errors or omissions in this Guide, the *WFCM*, nor for engineering designs or plans prepared from it.

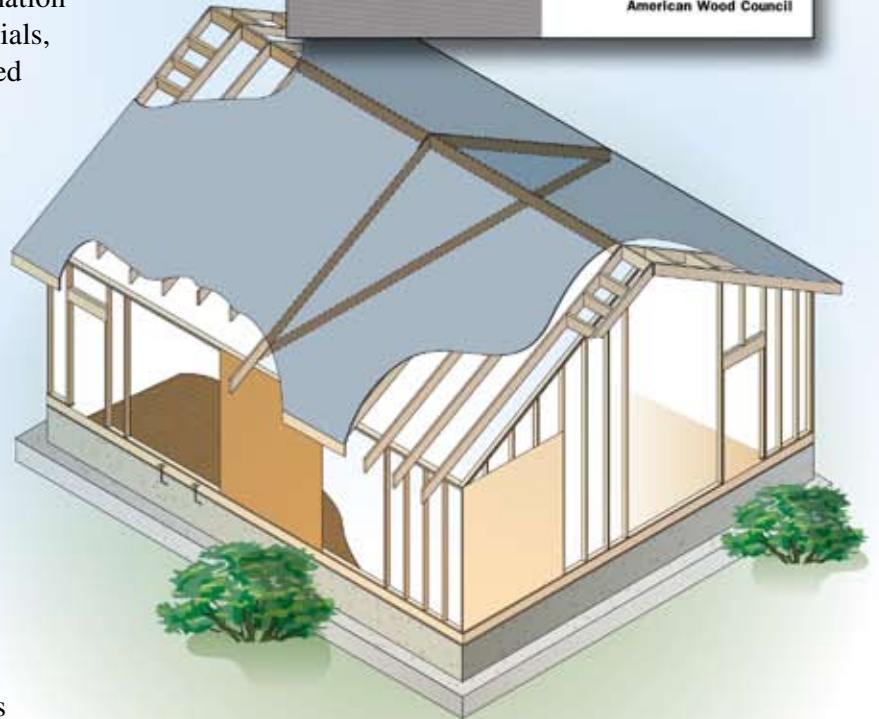
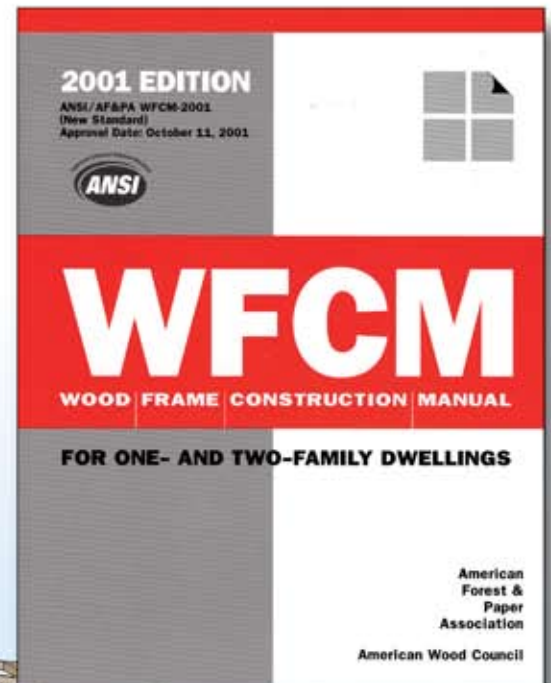

This page left blank intentionally.

1 General Provisions

1.1 SCOPE

This Guide to Wood Construction in High Wind Areas: 90 MPH Exposure B Wind Zone (Guide) establishes a specific set of prescriptive, wind-resistive structural requirements for one- and two-family wood-frame residential buildings of sizes and shapes specified in the “Applicability” section (1.2) of this chapter. The provisions of this Guide are directed toward ensuring structural integrity for resisting wind loads. In addition, provisions of this Guide are derived from the wind provisions found in the ANSI/AF&PA 2001 *Wood Frame Construction Manual (WFCM) for One- and Two-Family Dwellings*.

Wind load requirements of this Guide are based on 90 mile per hour, 3-second-gust wind speeds for Exposure B locations. Buildings located in Exposure C shall be designed in accordance with the *WFCM*.

Structural elements not complying with the conditions contained in this Guide shall be designed in accordance with the *WFCM* or the governing building code.

The provisions of this Guide are not intended to preclude the use of other materials or methods of construction. When alternative methods or materials are used, design loads and capacities shall be determined in accordance with the *WFCM* or the governing building code.

Tabulated values in this Guide shall be permitted to be interpolated unless otherwise noted in the applicable table footnotes.

Design Concepts

This Guide relies on the following concepts:

- Roofs, ceilings and floors are designed as diaphragms, which receive lateral loads from roof and exterior walls (assuming the wind blowing from any direction) and transfer these loads to shear walls.
- Exterior walls are designed to resist wind forces and transfer the lateral forces to diaphragms. Exterior walls, foundations, and connections shall be designed to resist lateral and uplift loads received from the roof by means of a continuous load path. Exterior walls are designed to resist wind loads assuming flexible finishes.
- Except for openings, exterior walls are designed as entirely sheathed with wood structural panels or structural fiberboard panels, including areas above and/or below openings.
- Openings shall not exceed nominal 6'-8" in height.
 - Exception: Opening heights of up to 8' shall be permitted when 5% is added to the percent full-height sheathing requirements in Tables 10 and 11 (See pages 18 and 19).
- The tabulated wind requirements in this document are based on fully enclosed buildings where openings are designed for the appropriate wind loads. Where required by the governing building code, protection of openings shall be provided to maintain a fully enclosed building envelope.
- The foundation provisions specified in this Guide are limited to the attachment of the building to the foundation. An adequate foundation system shall be provided to resist all required loads. Engineered and prescriptive design of the foundation for gravity, lateral, and uplift loads, including uplift and hold down anchorage, shall be provided in accordance with the governing building code.

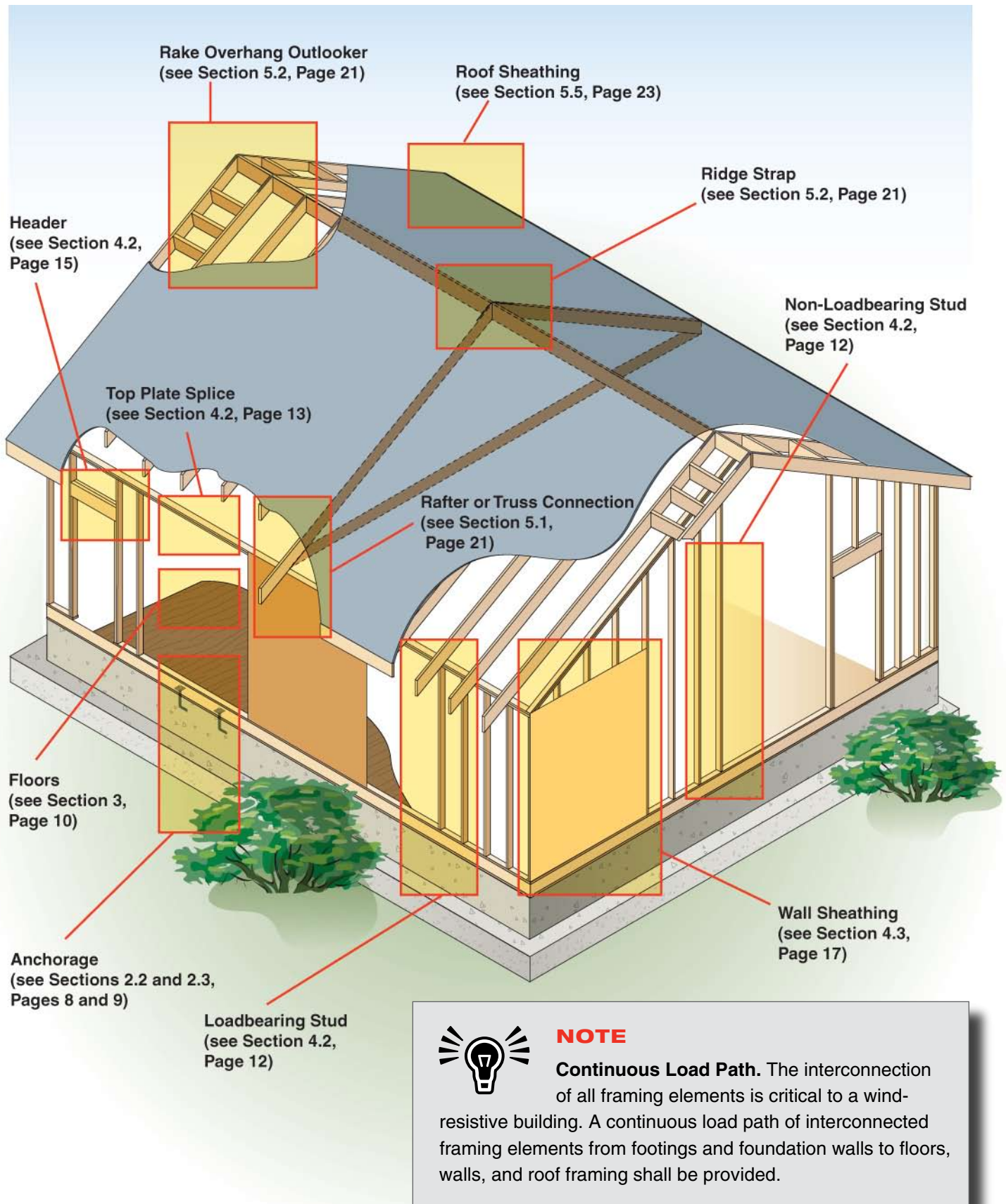

Figure 1. Master Building Frame (For Illustrative Purposes Only)

1.2 APPLICABILITY

Building Height

The building shall not exceed two stories or a mean roof height of 33 feet, measured from average grade to average roof elevation (See Figure 2).

For purposes of determining uplift and lateral bracing requirements, the roof shall be considered an additional story when the roof slope exceeds 6 in 12. The maximum roof slope is 12 in 12.

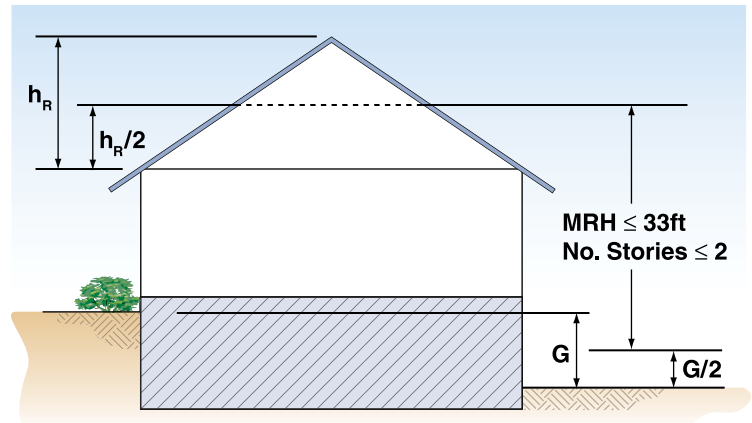

Figure 2. Mean Roof Height (MRH)

Building Dimension

- The maximum building dimension (L) shall not be greater than 80 feet.
- The minimum building dimension (W) shall not be greater than 80 feet.
- The maximum span (horizontal projection) of the roof trusses or rafters covered under the scope of this Guide are limited to 36 feet; however, combinations of these systems can be used for a total inscribed dimension of 80 feet.

Building Shape

- **Rectangular Buildings.** Design provisions in this Guide assume that buildings are rectangular in shape. Walls shall be permitted to be offset by a maximum of 4 ft. (such as projecting bays, inset porches, or other irregular shapes) without requiring detailing.
- **Non-rectangular Buildings.** In this Guide, non-rectangular buildings are designed as a rectangular building with dimensions that inscribe the non-rectangular building for purposes of determining lateral resistance requirements (See Figure 3).
 - ❑ Aspect ratios for these buildings shall be calculated as shown in Table 1 (page 6) and Figure 4.
 - ❑ The longest inscribed building dimension shall be assumed to be the building length, L , and the shortest inscribed building dimension shall be assumed to be the building width, W .
 - ❑ The required length of full-height exterior sheathing in Section 4.3 is to be distributed in each wall line segment in proportion to the segment length divided by the overall building dimension. Hold downs shall be placed at each end of wall line segments.
 - ❑ For conditions where non-rectangular buildings must be designed as separate structures joined at common walls, the *WFCM* should be used.

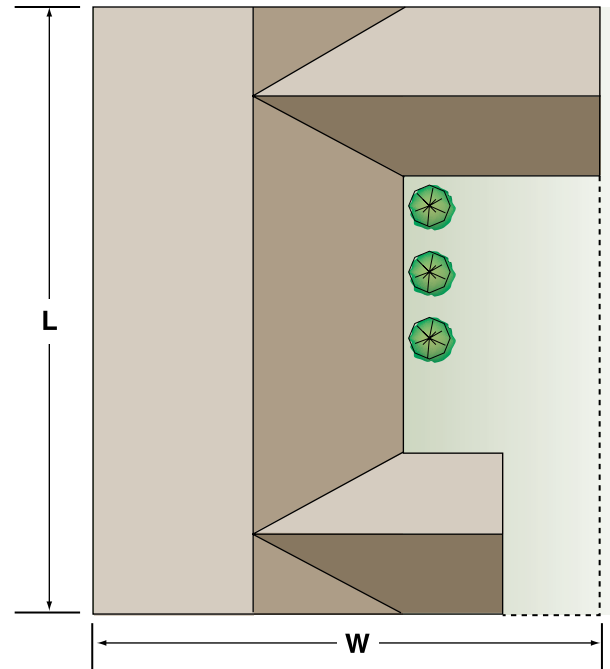

Figure 3. Incribed Building Dimensions

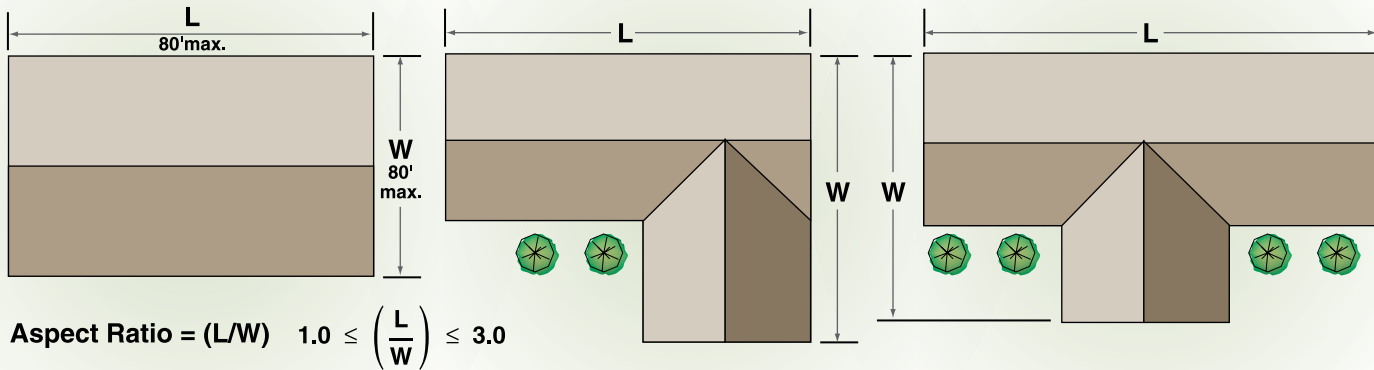

Figure 4. Building Aspect Ratios

Table 1. Maximum Building Lengths for Permitted Building Aspect Ratios

	Building Aspect Ratio (L/W)								
	1.00	1.25	1.50	1.75	2.00	2.25	2.50	2.75	3.00
Building Width, W (ft.)	Maximum Building Length, L (ft.)								
12	12	15	18	21	24	27	30	33	36
16	16	20	24	28	32	36	40	44	48
20	20	25	30	35	40	45	50	55	60
24	24	30	36	42	48	54	60	66	72
28	28	35	42	49	56	63	70	77	80
32	32	40	48	56	64	72	80	80	—
36	36	45	54	63	72	80	—	—	—
40	40	50	60	70	80	—	—	—	—
50	50	62	75	80	—	—	—	—	—
60	60	75	80	—	—	—	—	—	—
70	70	80	—	—	—	—	—	—	—
80	80	—	—	—	—	—	—	—	—

1.3 FRAMING CONNECTIONS

General framing connections shall be in accordance with the requirements of Table 2. Specific connections required for wind-resistant construction are provided with the assembly descriptions in other sections of this Guide. Where more restrictive connection requirements exist in the building code for other loading conditions, such as for gravity or seismic resistance, they shall apply.

Table 2. General Nailing Schedule

Joint Description	Number of Common Nails	Number of Box Nails	Nail Spacing
Roof Framing			
Blocking to Rafter (Toe-nailed)	2- 8d	2-10d	each end
Rim Board to Rafter (End-nailed)	2-16d	3-16d	each end
Wall Framing			
Top Plates at Intersections (Face-nailed)	4-16d	5-16d	at joints
Stud to Stud (Face-nailed)	2-16d	2-16d	24" o.c.
Header to Header (Face-nailed)	16d	16d	16" o.c. along edges
Floor Framing			
Joist to Sill, Top Plate or Girder (Toe-nailed) (Fig. 14)	4- 8d	4-10d	per joist
Blocking to Joist (Toe-nailed)	2- 8d	2-10d	each end
Blocking to Sill or Top Plate (Toe-nailed)	3-16d	4-16d	each block
Ledger Strip to Beam or Girder (Face-nailed)	3-16d	4-16d	each joist
Joist on Ledger to Beam (Toe-nailed)	3- 8d	3-10d	per joist
Band Joist to Joist (End-nailed) (Fig. 14)	3-16d	4-16d	per joist
Band Joist to Sill or Top Plate (Toe-nailed) (Fig. 14)	2-16d	3-16d	per foot
Roof Sheathing			
Wood Structural Panels			
rafters or trusses spaced up to 16" o.c.	8d	10d	6" edge / 12" field
rafters or trusses spaced over 16" o.c.	8d	10d	6" edge / 6" field
gable endwall rake or rake truss w/o gable overhang	8d	10d	6" edge / 6" field
gable endwall rake or rake truss w/ structural outlookers	8d	10d	6" edge / 6" field
gable endwall rake or rake truss w/ lookout blocks	8d	10d	4" edge / 4" field
Ceiling Sheathing			
Gypsum Wallboard	5d coolers	-	7" edge / 10" field
Wall Sheathing			
Wood Structural Panels			
studs spaced up to 24" o.c.	8d	10d	6" edge / 12" field
1/2" and 25/32" Fiberboard Panels	8d ¹	-	3" edge / 6" field
1/2" Gypsum Wallboard	5d coolers	-	7" edge / 10" field
Floor Sheathing			
Wood Structural Panels			
1" or less	8d	10d	6" edge / 12" field
greater than 1"	10d	16d	6" edge / 6" field

¹ Corrosion resistant 11 gage roofing nails and 16 gage staples are permitted, check IBC for additional requirements.

Nails. Unless otherwise stated, sizes given for nails are common wire sizes. Box and pneumatic nails of equivalent diameter and equal or greater length to the specified common nails may be substituted unless otherwise prohibited.

2 Foundation Anchorage

2.1 GENERAL LOADS

The house shall be anchored to the foundation system to resist the loads in Table 3 and the hold down requirement in Section 4.3. For pile and girder foundation systems or pier and beam foundation systems that support the floor joists on top of the girder or beam, the Stemwall Foundation loads in Table 3 shall be used. When the floor joists are hung on the sides of the girder or beam with proprietary joist hangers, the Slab-on-Grade loads in Table 3 shall be used. Ledgers are not permitted.

Table 3. Foundation Anchorage Loads

Raised-Floor Foundation Supporting:	Uplift ¹ (plf)	Lateral (plf)	Stemwall Foundations ²									Slab-on-Grade Foundations ³
			Building Aspect Ratio (L/W)									
			1.00	1.25	1.50	1.75	2.00	2.25	2.50	2.75	3.00	
			Shear (plf)									
Roof, Ceiling, and One Floor	66	89	135	169	203	236	270	304	338	371	405	730
Roof, Ceiling, and Two Floors	6	89	211	264	317	370	423	475	528	581	634	730

¹ For non-loadbearing walls, uplift connections need not exceed 60 plf.

² Shear connection requirements in the maximum building dimension (L) need not exceed the tabulated values for L/W=1.00.

³ Shear connection requirements are based on a required sheathing nail spacing of 3" o.c. in Tables 10-11. For reduced wood structural panel sheathing nailing requirements of 4" and 6" o.c. and for fiberboard sheathing, the shear loads can be reduced.

2.2 ANCHOR BOLTS

Where 5/8" anchor bolts are used to resist uplift, lateral, and shear loads provided in Table 3, the anchor bolts shall be installed per Table 4 using 3" x 3" x 1/4" plate washers (See Figure 5).

Table 4. Anchor Bolt Spacings

Raised-Floor Foundation Supporting:	Stemwall Foundations ¹									Slab-on-Grade Foundations
	Building Aspect Ratio (L/W)									
	1.00	1.25	1.50	1.75	2.00	2.25	2.50	2.75	3.00	
	5/8" Anchor Bolt Spacing (in.)									
Roof, Ceiling, and One Floor	72	72	72	72	66	59	53	48	44	24
Roof, Ceiling, and Two Floors	72	68	56	48	42	38	34	31	28	24

¹ The anchor bolt spacing in the maximum building dimension (L) need not be less than the tabulated spacing for L/W=1.00.

Concrete Basement or Stemwall Foundation

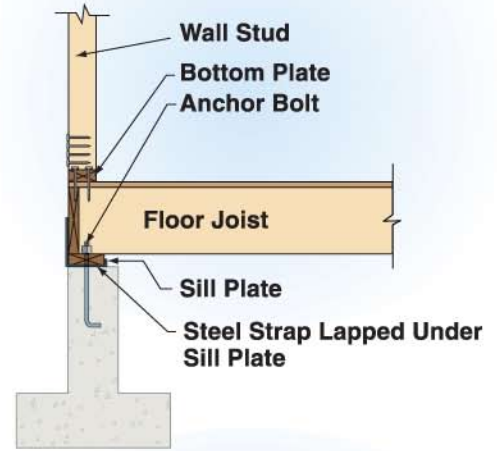
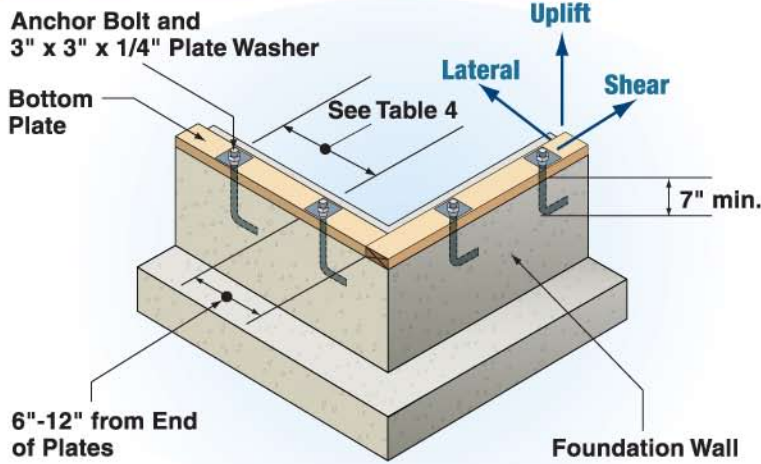

Concrete Masonry Unit Basement or Stemwall Foundation

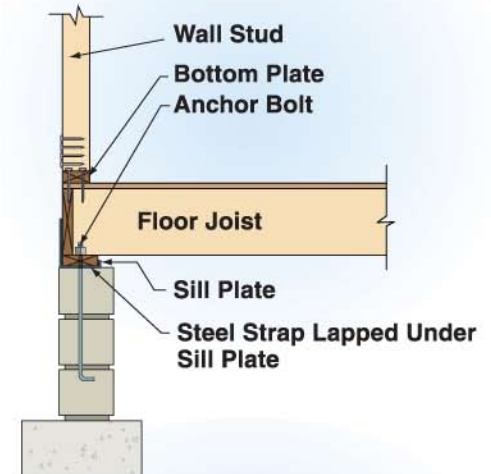
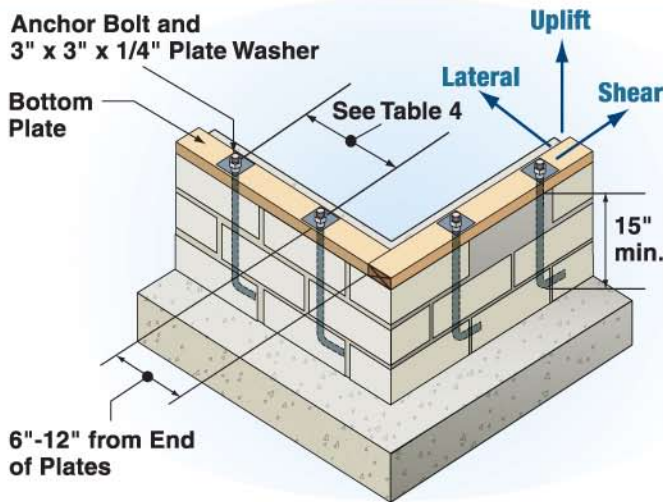

Slab-On-Grade Foundation

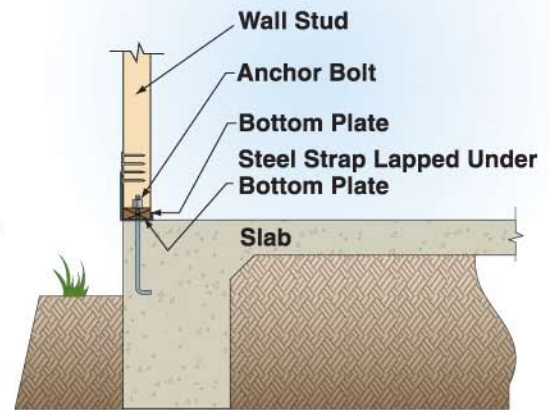
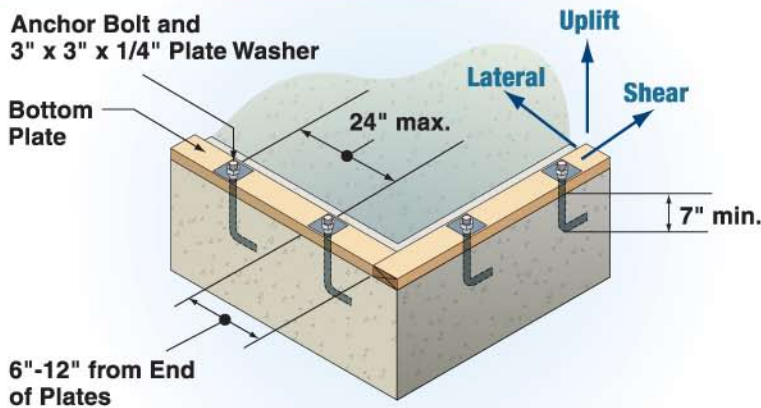

Figure 5. Anchor Bolts Resisting Uplift, Lateral, and Shear Loads.

2.3 ANCHORAGE AT OPENINGS

Additional anchorage shall be installed on each side of an opening to resist the loads in Table 9 (page 16 and 17).

3 Floors

3.1 GENERAL

- Framing Member Span.**
 Single spans of floor framing members shall not exceed 26 feet.
- Floor Openings.** Floor openings shall not exceed the lesser of 12 feet or 50% of the building dimension (See Figure 6).

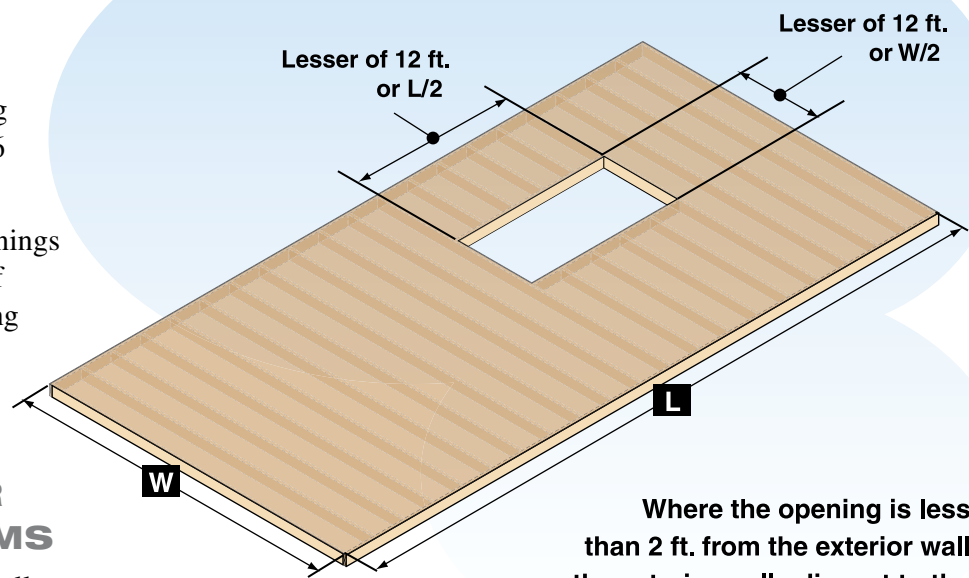

Where the opening is less than 2 ft. from the exterior wall, the exterior wall adjacent to the opening shall be framed using full height studs

3.2 WOOD FLOOR JOIST SYSTEMS

- Floor Joists.** Floor joists shall be sized in accordance with the governing building code.
- Floor Joists That Support Loadbearing Walls.**
 Loadbearing walls parallel to joists shall be directly supported by beams, girders, or other loadbearing walls. Loadbearing walls perpendicular to joists shall not be offset from supporting girders, beams, or other loadbearing walls by more than the depth of the joists (See Figure 7).
- Cantilevered Floor Joists.** Lumber joists shall be located directly over studs except at beams and headers.

Figure 6. Floor Diaphragm Opening Limits

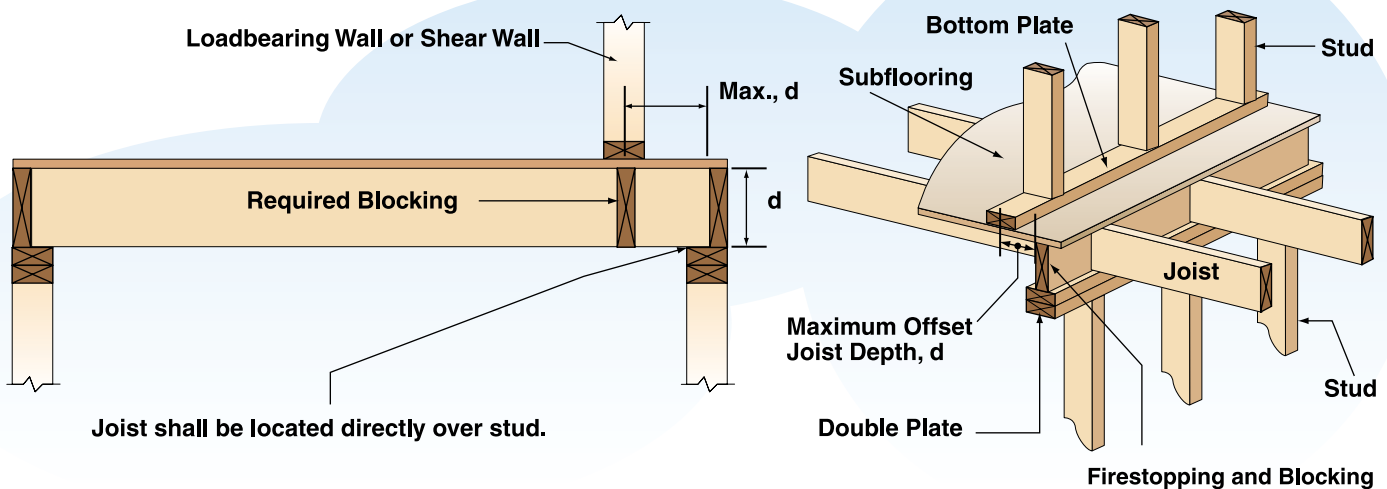

Figure 7. Setback Limits for Loadbearing Wall or Shear Wall and Limit on Loadbearing Wall Offset from Support

- **Cantilevered Floor Joists that Support Loadbearing or Shear Wall.** Overhang lengths of cantilevered floor joists supporting a loadbearing or shear wall at the end of the cantilever shall be limited to the depth, d , of the joists (See Figure 8).

3.3 WOOD I-JOIST FLOOR SYSTEMS

Wood I-joist floor systems shall comply with requirements set forth in the manufacturer's code evaluation report.

3.4 WOOD FLOOR TRUSS SYSTEMS

Wood floor truss systems shall be manufactured and installed in accordance with *ANSI/TPI 1 National Design Standard for Metal Plate Connected Wood Truss Construction*, the truss design drawings, and/or the manufacturer's code evaluation report.

3.5 FLOOR SHEATHING

Floors shall be sheathed in accordance with the governing building code.

3.6 FLOOR BRACING

Blocking and connections shall be provided at panel edges perpendicular to floor framing members in the first two truss or joist spaces and shall be spaced at a maximum of 4 feet on center (See Figure 9). Nailing requirements are given in Table 2 (See page 7).

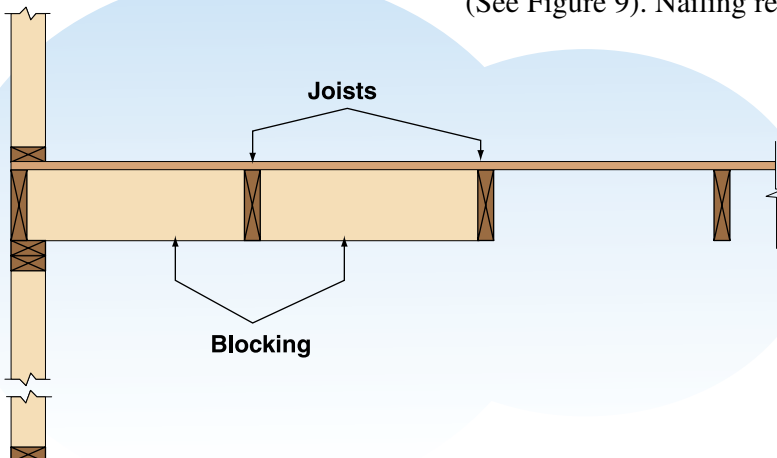

Figure 9. Floor Bracing

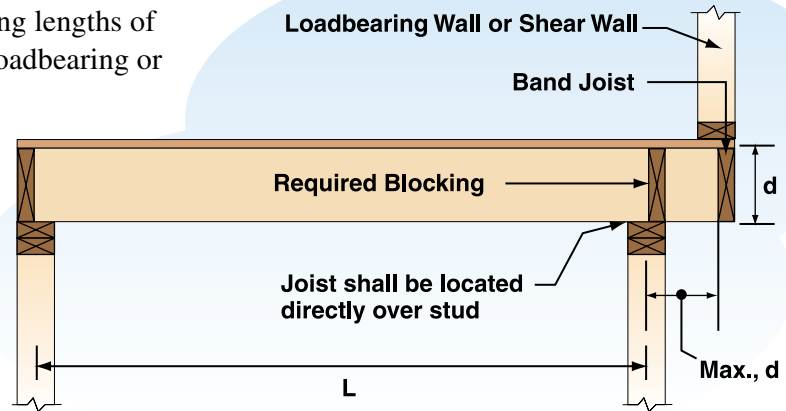

Figure 8. Cantilever with Loadbearing Wall or Shear Wall

4 Walls

4.1 GENERAL

- **Wall Heights.** Loadbearing walls shall not exceed 10 feet in height. Non-loadbearing walls shall not exceed 20 feet in height (See Figure 10).
- **Wall Stud Spacing.** Wall stud spacing shall not exceed 24 inches on center (See Figure 10).
- **Wall Story Offsets.** Upper story wall segments shall not be offset from lower story wall segments by more than the depth, d, of the floor framing members (See Figures 7 and 8).

4.2 EXTERIOR WALLS

- **Wood Studs.** Wall studs of #2 or Stud grade lumber (including Douglas Fir-Larch, Hem Fir, Southern Pine, and Spruce-Pine-Fir) shall not exceed the maximum lengths specified in Table 5 (See Figure 10).

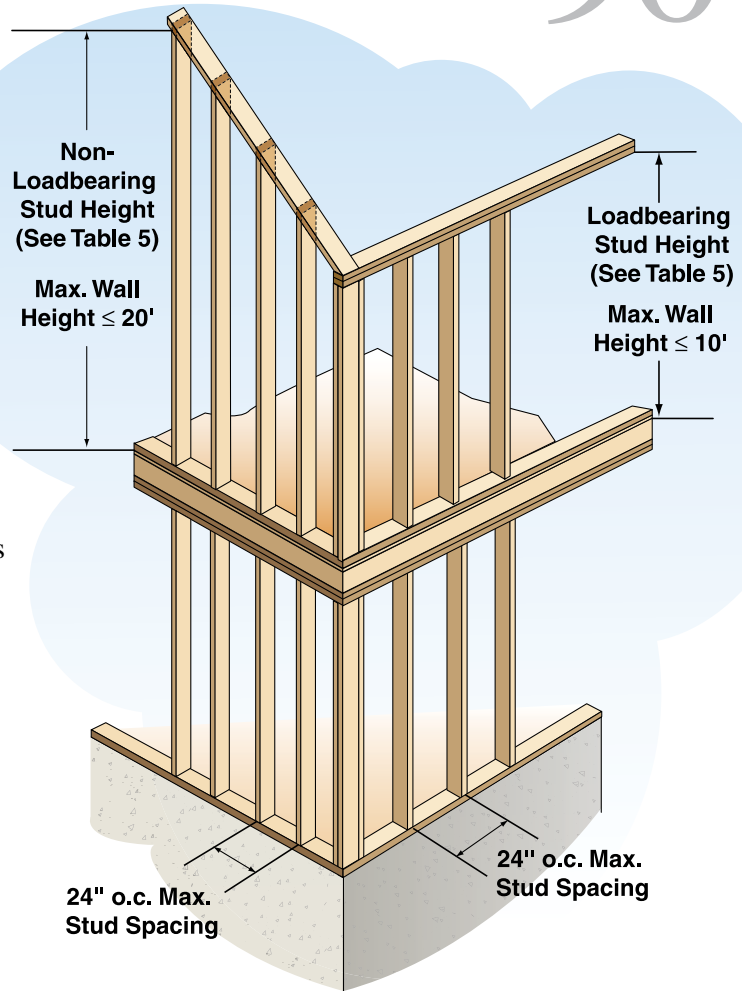

Figure 10. Maximum Wall and Stud Height and Stud Spacing

Table 5. Exterior Wall - Wood Studs

		2x4		2x6		2x8			
		Stud Grade							
		#2	Stud	#2	Stud	#2	Stud		
Exterior Studs	Stud Spacing	Maximum Stud Length							
		Non-Loadbearing Studs	12" o.c.	14' - 7"	14' - 0"	19' - 9"	19' - 9"	19' - 9"	19' - 9"
			16" o.c.	13' - 2"	12' - 0"	19' - 9"	18' - 0"	19' - 9"	19' - 9"
24" o.c.	11' - 5"		9' - 8"	18' - 4"	14' - 6"	19' - 9"	18' - 8"		
Loadbearing Studs Supporting Roof and Ceiling Only	12" o.c.	9' - 9"	9' - 9"	9' - 9"		9' - 9"			
	16" o.c.	9' - 9"	9' - 9"						
	24" o.c.	9' - 9"	9' - 8"						
Loadbearing Studs Supporting Roof, Ceiling, and 1 Floor Only	12" o.c.	9' - 9"	9' - 9"	9' - 9"		9' - 9"			
	16" o.c.	9' - 9"	9' - 9"						
	24" o.c.	NP							

NP= Not Permitted

■ **Stud Continuity.** Studs shall be continuous between horizontal supports, including but not limited to: headers, girders, floor diaphragm assemblies, ceiling diaphragm assemblies, and roof diaphragm assemblies. Studs in gable endwalls adjacent to cathedral ceilings shall be continuous from the uppermost floor to the ceiling diaphragm or to the roof diaphragm.

■ **Bracing Gable End Walls.** When attic floor or ceiling assemblies are used to brace gable endwalls, the assemblies shall extend from the endwall for a distance of at least 1/3 of the building width when using wood structural panels and for a distance of at least 60% of the building width when using gypsum wallboard ceilings. Sheathing and fasteners shall be as specified in Table 2 (See page 7) and Figure 11.

■ **Top Plates.** Double top plates shall be provided at the top of all exterior stud walls. The double plates shall overlap at corners and at intersections with other exterior or interior loadbearing walls (See Figure 12). Double top plates shall be lap-spliced with end joints offset in accordance with the minimum requirements given in Table 6 (See Figure 13).

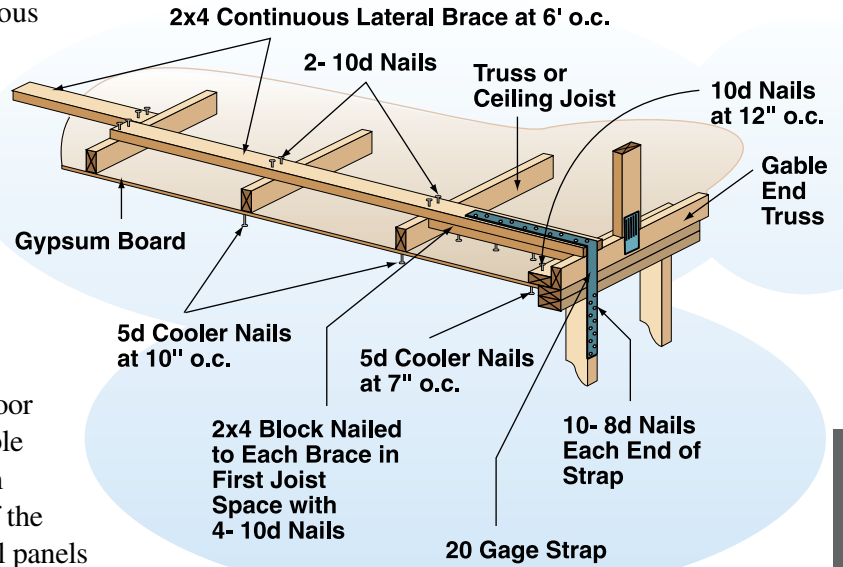

Figure 11. Ceiling Bracing Gable Endwall

Figure 12. Top Plate Intersection Detail

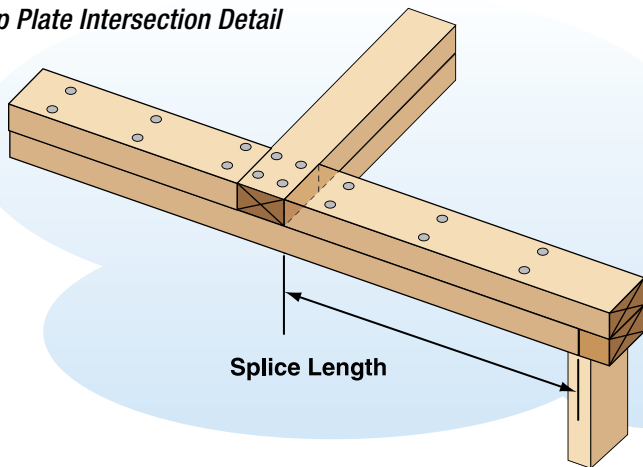

Figure 13. Top Plate Splice Length

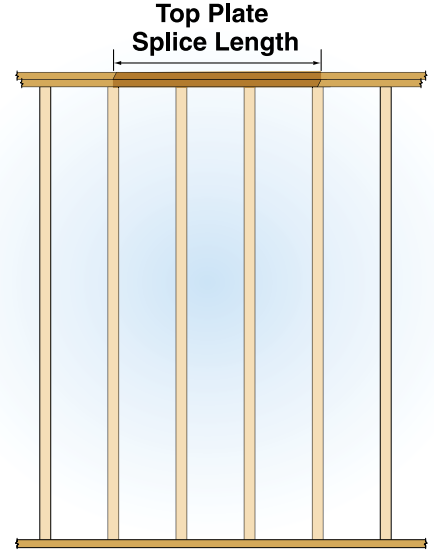

Table 6. Top Plate Splice

Building Dimension of Wall Containing Top Plate Splice (ft.)												
Splice Length (ft.)	12	16	20	24	28	32	36	40	50	60	70	80
Number of 16d Common Nails per Each Side of Splice												
2	4	6	8	8	NP	NP	NP	NP	NP	NP	NP	NP
4	4	6	7	8	10	12	14	16	NP	NP	NP	NP
6	4	6	7	8	10	12	14	16	20	24	NP	NP
8	4	6	7	8	10	12	14	16	20	24	28	32

NP= Not Permitted

- Wall Assembly to Wall Assembly Connections.** Story-to-story connections from upper story wall studs to lower story wall studs shall be in accordance with the requirements of Table 7 (See Figure 14). When upper story wall studs are not located directly above lower story wall studs, the studs shall be attached to a common member in the floor assembly with connections in accordance with Table 7.

Table 7. Wall Connections at Loadbearing Walls

Stud Spacing	Roof Framing Span (ft.)							Lateral
	12	16	20	24	28	32	36	No. of 16d Common Nails (Endnailed)
	Uplift (lb.)							
12" o.c.	2	12	23	33	44	55	66	2
16" o.c.	2	16	30	45	59	74	88	2
24" o.c.	3	24	45	67	89	110	132	2

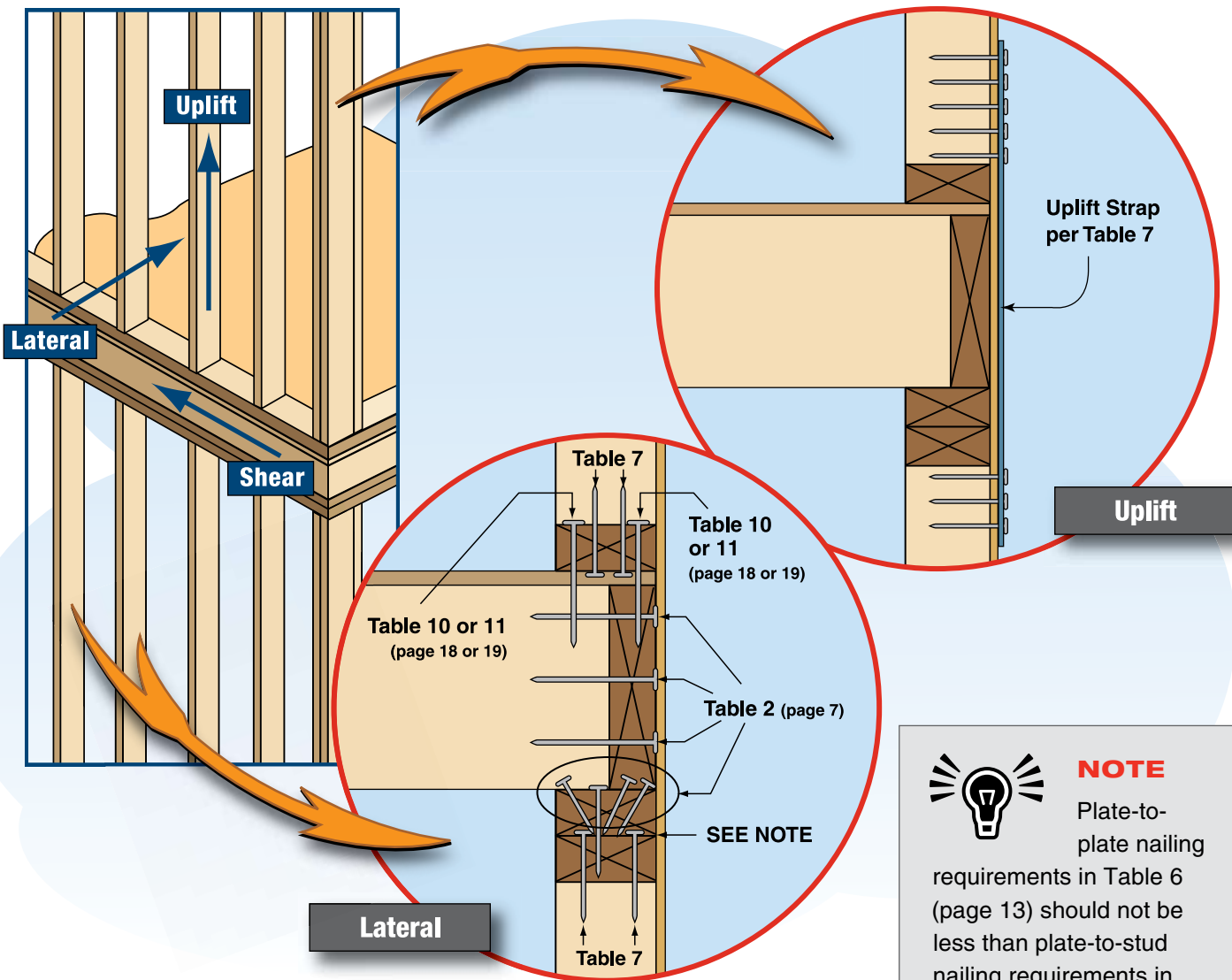

Figure 14. Story-to-Story Uplift and Lateral Connections

- Endwall Assemblies.** Rake overhang-to-wall, wall-to-wall, and wall-to-foundation connections shall be in accordance with the requirements given in Table 8 (See Figures 15 and 16). Walls which do not support the roof assembly and are attached in accordance with Table 2 (page 7) need no additional uplift connections. Where gable end rake trusses are used, rake truss-to-stud connections shall resist the uplift and lateral loads provided by the truss designer.

Table 8. Wall Connections for Endwall Assemblies

Stud Spacing	Uplift (lb)	Wall Height (ft.)						
		8	10	12	14	16	18	20
Plate-to-Stud - No. of 16d Common Nails – (Endnailed)								
12" o.c.	85	2	2	2	2	2	2	2
16" o.c.	113	2	2	2	2	2	2	2
24" o.c.	170	2	2	2	2	2	2	2

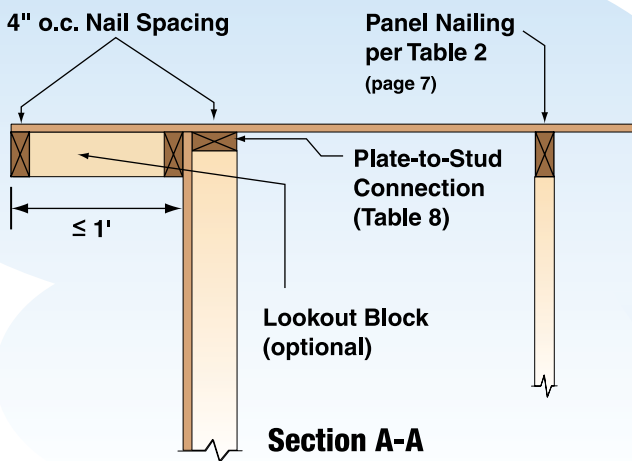

Figure 15. Full-Height Gable Endwall Stud

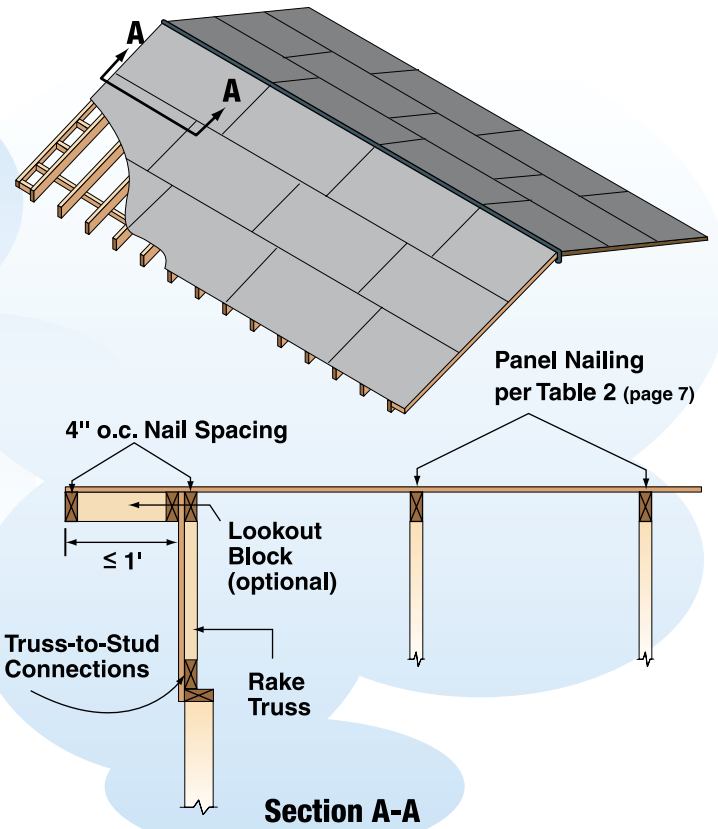

Figure 16. Rake Truss

- Wall Openings.** Headers shall be provided over all exterior wall openings. Headers shall be supported by wall studs, jack studs, hangers, or framing anchors (See Figure 17).
- Headers.** Headers shall be sized for gravity loads in accordance with the governing building code. Exterior wall header spans for #2 grade lumber (including Douglas-Fir-Larch, Hem-Fir, Southern Pine, and Spruce-Pine-Fir) shall not exceed the limits in Table 9 (See page 16).

- **Full Height Studs.** Full height studs shall meet the same requirements as exterior wall studs selected in Table 5 (See page 12). The minimum number of full height studs at each end of the header shall not be less than half the number of studs replaced by the opening, in accordance with Table 9. Full height studs shall be permitted to replace an equivalent number of jack studs, when adequate gravity connections are provided.
- **Window Sill Plates.** Maximum spans for window sill plates used in exterior walls shall not exceed the spans given in Table 9.
- **Connections around Wall Openings.**
 - **Header and/or Girder to Stud Connections.** Headers and/or girder to stud connections shall be in accordance with the requirements given in Table 9. Window sill plate to stud connections shall be in accordance with the requirements given in Table 9.
 - **Top and Bottom Plate to Full Height Studs.** Each full height stud shall be connected in accordance with the requirements given in Table 9.

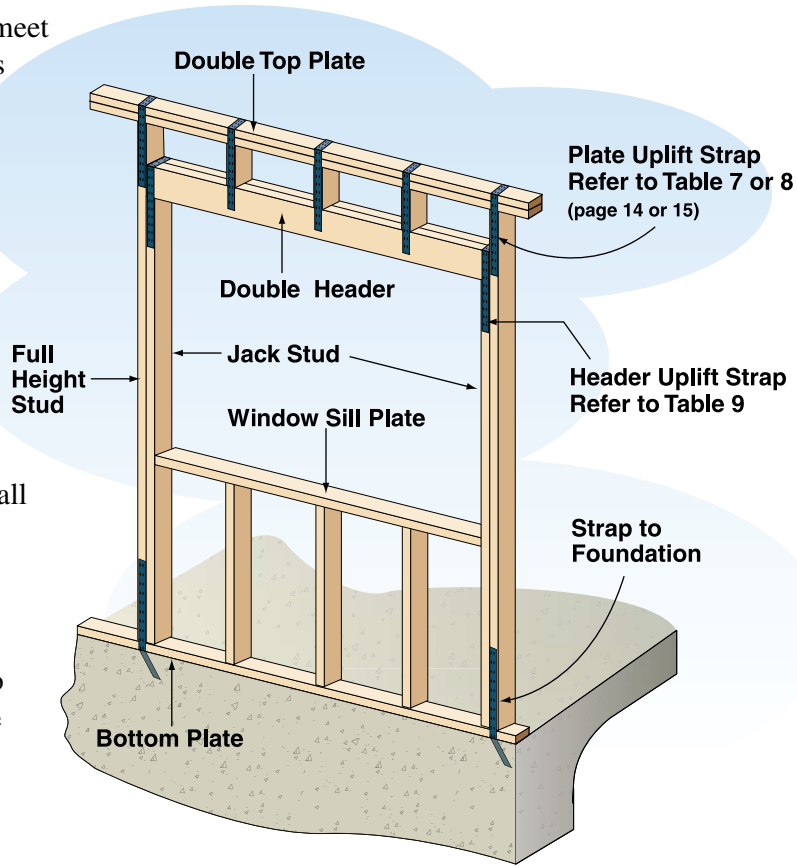

Figure 17. Studs and Headers Around Wall Openings

Table 9. Wall Openings – Headers in Loadbearing Walls

Header Span (ft.)	Minimum Header Size	Requirements at Each End of Header		
		Number of Full-Height Studs	Uplift (lb.)	Lateral (lb.)
Headers in Loadbearing Walls				
2	2 - 2x4	1	126	89
3	2 - 2x4	2	189	134
4	2 - 2x4	2	252	178
5	2 - 2x4	3	315	223
6	2 - 2x4	3	378	267
7	2 - 2x6	3	441	312
8	2 - 2x8	3	504	356
9	2 - 2x10	3	567	401
10	2 - 2x12	4	630	445
11	3 - 2x10	4	693	490
12	3 - 2x12	4	756	534

Table 9. Wall Openings – Headers in Non-Loadbearing Walls (continued)

Header Span (ft.)	Minimum Header Size	Requirements at Each End of Header		
		Number of Full-Height Studs	Uplift (lb.)	Lateral (lb.)
Headers in Non-Loadbearing Walls and Window Sill Plates¹				
2	1 - 2x4 (flat)	1	60	89
3	1 - 2x4 (flat)	2	90	134
4	1 - 2x4 (flat)	2	120	178
5	1 - 2x4 (flat)	3	150	223
6	1 - 2x4 (flat)	3	180	267
7	1 - 2x6 (flat)	3	210	312
8	1 - 2x6 (flat)	3	240	356
9	1 - 2x6 (flat)	3	270	401
10	1 - 2x6 (flat)	4	300	445
11	2 - 2x6 (flat)	4	330	490
12	2 - 2x6 (flat)	5	360	534

4 WALLS

¹ For non-loading bearing walls and window sill plates, 2 -2x4 (flat) can be substituted for 1 -2x6 (flat)

4.3 EXTERIOR WALL SHEATHING

- **Exterior Wall Sheathing.** Exterior walls shall be sheathed with a minimum of 7/16" wood structural panel sheathing or 1/2" cellulosic fiberboard sheathing and attached per Table 2 (page 7). The minimum required percentage of full-height sheathing in the wall lines is provided in Tables 10 and 11 (pages 18 and 19). To meet the requirements for percentage full-height sheathing, a full-height wall segment shall not be less than 27-1/2" in an 8' wall, 31" in a 9' wall, or 34" in a 10' wall (aspect ratio ≤ 3-1/2:1). Exterior sheathing shall be continuous from the bottom plate to the upper top plate, with all panel edges over framing.
- **Hold Downs.** Hold downs with a capacity in accordance with Table 10 or 11 (page 18 or 19) are required in the full-height segment at each end of a wall line. When full height segments meet at a corner, a single hold down shall be permitted to be used to resist the overturning forces in both directions when sized to resist the larger load and the corner framing in the adjoining walls is fastened together to transfer the uplift load (See Figures 18a and 18b). A continuous load path must be maintained to the foundation. Where hold downs on a top floor align with hold downs on a lower floor, the combined capacity of the two hold downs must be resisted by anchorage to the foundation.
- **Exterior Wall Cladding.** Exterior wall cladding shall be rated for a 90 mph Exposure B 3-second gust wind speed and be installed per the manufacturer’s instructions.

Table 10. Percentage of Full-Height Sheathing in Minimum Building Dimension (W)

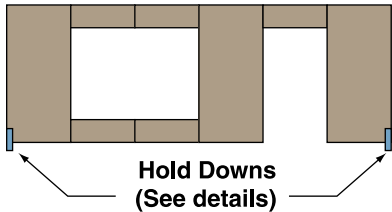

Exterior Sheathing Type	Wood Structural Panel Sheathing			Fiberboard Sheathing	
	7/16"			1/2"	25/32"
Nail Type	8d Common	8d Common	8d Common	8d Roofing	8d Roofing
Edge Nail Spacing	6" o.c.	4" o.c.	3" o.c.	3" o.c.	3" o.c.
Field Nail Spacing	12" o.c.	12" o.c.	12" o.c.	6" o.c.	6" o.c.
Bottom Plate-to-Frame Shear Connection (16d Common Nails)	436 plf (3 / ft.)	590 plf (3 / ft.)	730 plf (4 / ft.)	225 plf (2 / ft.)	275 plf (2 / ft.)
Hold Down Capacity	4,360 lb.	5,900 lb.	7,300 lb.	2,250 lb.	2,750 lb.

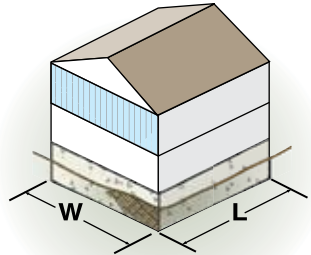
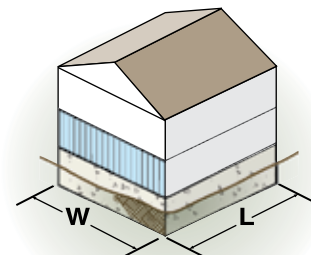
Shear Wall Line Beneath	Building Aspect Ratio (L/W)	Percent Full-Height Sheathing on Each Exterior Wall Line				
 <p>Roof and Ceiling</p>	1.00	23%	18%	15%	41%	35%
	1.25	28%	22%	18%	48%	41%
	1.50	33%	25%	21%	55%	48%
	1.75	37%	29%	24%	62%	54%
	2.00	42%	33%	27%	67%	59%
	2.25	46%	36%	30%	73%	64%
	2.50	49%	39%	33%	78%	69%
	2.75	53%	42%	36%	82%	73%
	3.00	57%	45%	38%	87%	77%
 <p>Roof, Ceiling, and One Floor</p>	1.00	47%	37%	31%	75%	65%
	1.25	55%	44%	37%	85%	76%
	1.50	63%	51%	43%	94%	84%
	1.75	70%	57%	49%	NP	92%
	2.00	76%	62%	54%	NP	99%
	2.25	82%	68%	59%	NP	NP
	2.50	87%	72%	63%	NP	NP
	2.75	91%	77%	67%	NP	NP
	3.00	96%	81%	71%	NP	NP

NP= Not Permitted

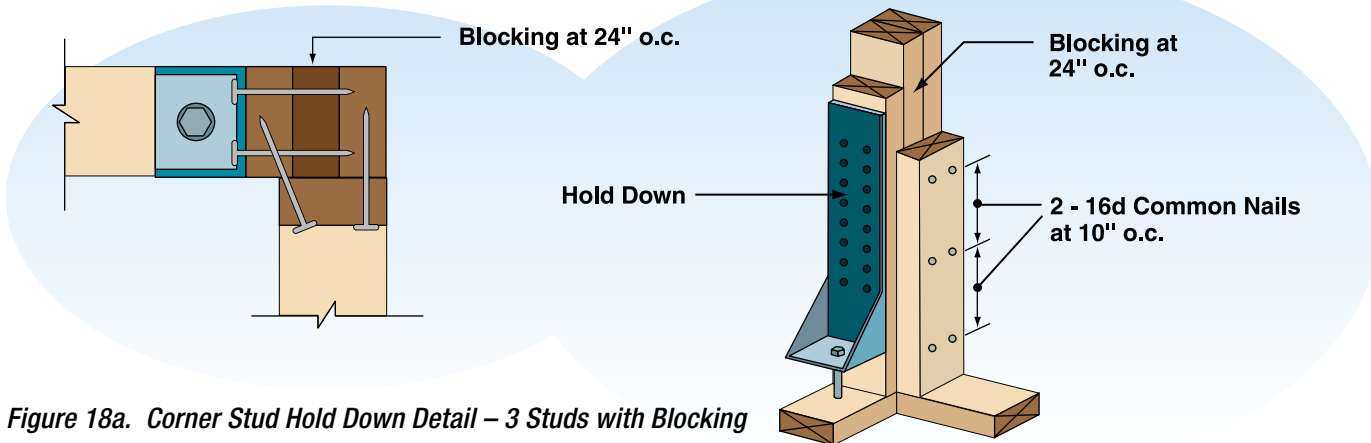
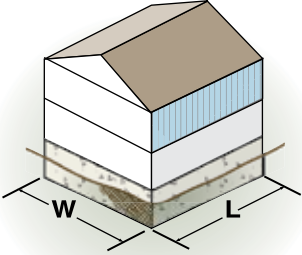
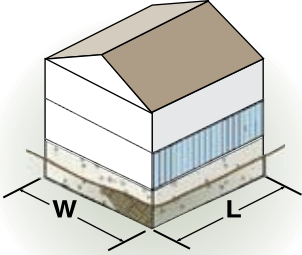

Figure 18a. Corner Stud Hold Down Detail – 3 Studs with Blocking

Table 11. Percentage of Full-Height Sheathing in Maximum Building Dimension (L)

Exterior Sheathing Type	Wood Structural Panel Sheathing			Fiberboard Sheathing	
	7/16"			1/2"	25/32"
Nail Type	8d Common	8d Common	8d Common	8d Roofing	8d Roofing
Edge Nail Spacing	6" o.c.	4" o.c.	3" o.c.	3" o.c.	3" o.c.
Field Nail Spacing	12" o.c.	12" o.c.	12" o.c.	6" o.c.	6" o.c.
Bottom Plate-to-Floor Shear Connection (16d Common Nails)	436 plf (3 / ft.)	590 plf (3 / ft.)	730 plf (4 / ft.)	225 plf (2 / ft.)	275 plf (2 / ft.)
Hold Down Capacity	4,360 lb.	5,900 lb.	7,300 lb.	2,250 lb.	2,750 lb.

Shear Wall Line Beneath	Building Aspect Ratio (L/W)	Percent Full-Height Sheathing on Each Exterior Wall Line				
Roof and Ceiling 	1.00	23%	18%	15%	41%	35%
	1.25	19%	14%	12%	34%	29%
	1.50	16%	12%	10%	29%	24%
	1.75	14%	11%	9%	25%	21%
	2.00	12%	9%	8%	23%	19%
	2.25	11%	8%	7%	20%	17%
	2.50	10%	7%	6%	18%	15%
	2.75	9%	7%	6%	17%	14%
	3.00	8%	6%	5%	16%	13%
Roof, Ceiling, and One Floor 	1.00	47%	37%	31%	75%	65%
	1.25	39%	31%	26%	64%	56%
	1.50	34%	26%	22%	57%	49%
	1.75	30%	23%	19%	51%	44%
	2.00	27%	20%	17%	46%	39%
	2.25	24%	18%	15%	42%	36%
	2.50	22%	17%	14%	38%	33%
	2.75	20%	15%	13%	36%	30%
	3.00	19%	14%	12%	33%	28%

NP= Not Permitted

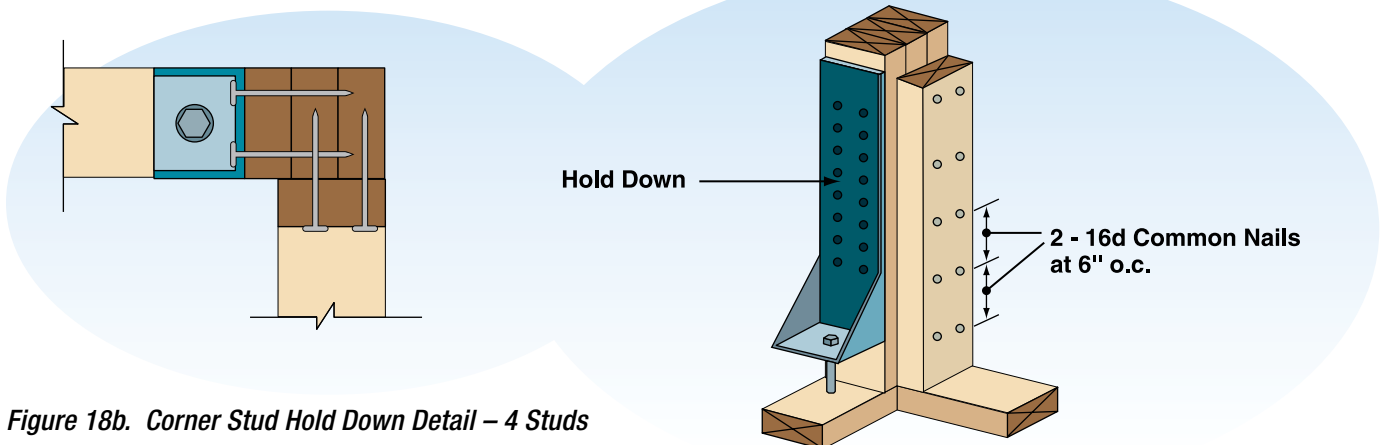

Figure 18b. Corner Stud Hold Down Detail – 4 Studs

5 Roofs

5.1 GENERAL

- **Framing Member Span.** Roof framing spans shall not exceed 36 feet (See Figure 19).
- **Roof Openings.** Roof openings shall not exceed the lesser of 12 feet or 50% of the building dimension (See Figure 6).
- **Roof Slope.** The roof slope shall not be greater than 12 in 12.

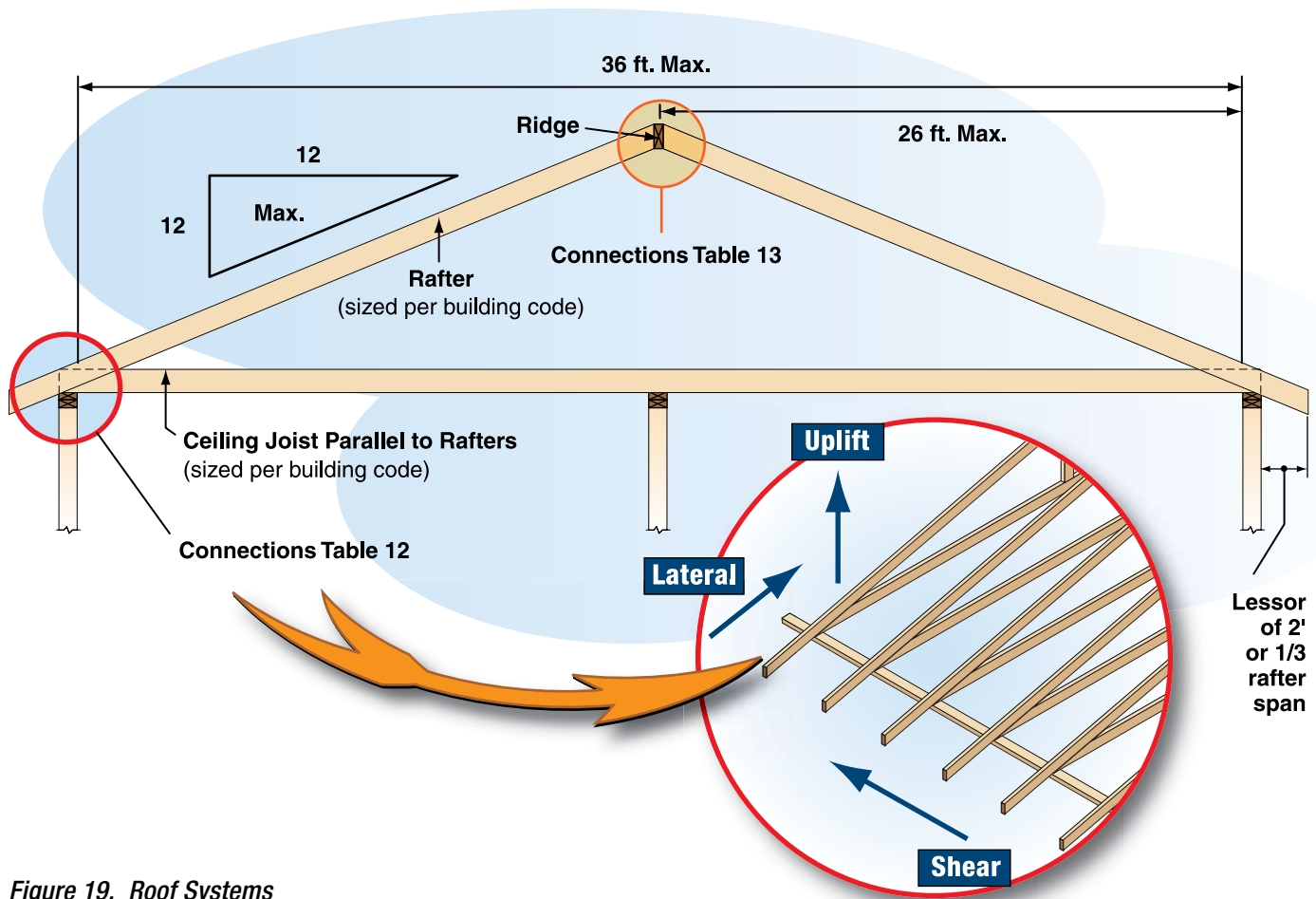

Figure 19. Roof Systems

5.2 WOOD RAFTER SYSTEMS

- **Rafters.** Rafters shall be sized in accordance with the governing building code. Rafters shall be connected to exterior walls in accordance with Table 12 (see page 21).
- **Rafter Overhangs.** Rafter overhangs shall not exceed the lesser of one-third of the rafter span or 2 feet (See Figure 19).

■ **Rake Overhangs.**

- ❑ **Outlookers.** Where structural outlookers are used, the outlookers shall be constructed using 2x4 purlins connected in accordance with Table 14. Rake overhangs shall not be spaced more than 24" or exceed the lesser of one-half of the purlin length or 2 feet (See Figure 20).
- ❑ **Lookout Blocks.** Where non-structural lookout blocks are used, the rake overhang shall not exceed 1 foot (See Figures 15 and 16).

■ **Ridge Construction.**

- ❑ **Ridge Beam.** A ridge beam shall be installed at the roof peak. The ridge beam shall be in accordance with the governing building code. Rafters shall bear directly on the ridge beam or be supported by hangers or framing anchors. Each rafter shall be connected to the ridge beam or to an opposing rafter (See Figure 20) with a ridge strap in accordance with the requirements of Table 13 (page 22). Ceiling joists or rafter ties shall not be required where a ridge beam is provided.
- ❑ **Ridge Board.** A ridge board shall be permitted to be substituted for a ridge beam when roof slopes equal or exceed 3 in 12. The ridge board shall be at least 1 inch nominal in thickness and not less than the depth of the cut end of the rafter. The rafters shall be placed directly opposite each other. Ceiling joists or rafter ties shall be used to provide a continuous tie between exterior walls. Ceiling joist or rafter tie to rafter connections shall be in accordance with the governing building code. Opposing rafters shall be connected at the ridge with ridge straps in accordance with the requirements in Table 13 (See page 22).
- ❑ **Collar Ties.** Ridge straps are not required when collar ties of nominal 1x6 or 2x4 lumber are located in the upper third of the attic space and attached to rafters using 5-10d nails at each end. For reduced requirements, see the *WFCM*.

■ **Ceiling Joists.** Ceiling joists shall be sized in accordance with the governing building code.

- ❑ **Open (Cathedral) Ceilings.** When ceiling joists and rafter ties are omitted and the rafters are used to create an open (cathedral) ceiling, rafter ends shall be supported on bearing walls, headers, or ridge beams. Rafters shall be attached to the wall assembly in accordance with Table 12 and attached to the ridge beam in accordance with Table 13 (page 22).

Table 12. Truss, I-Joist, or Rafter Connections at Loadbearing Walls

Truss, I-Joist or Rafter Spacing	Roof Framing Span (ft.)							Lateral (lb.)	Shear (lb.)
	12	16	20	24	28	32	36		
	Uplift (lb.)								
12" o.c.	62	72	83	93	104	115	126	89	39
16" o.c.	82	96	110	125	139	154	168	119	52
19.2" o.c.	98	115	132	150	167	184	202	142	62
24" o.c.	123	144	165	187	209	230	252	178	78

Table 13. Ridge Strap Connections

Roof Span (ft.)	Roof Pitch				
	3:12	4:12	5:12	6:12	7:12-12:12
12	94	79	62	57	57
16	126	106	83	76	75
20	157	132	103	95	94
24	189	158	124	115	113
28	220	185	144	134	132
32	252	211	165	153	151
36	283	238	186	172	170

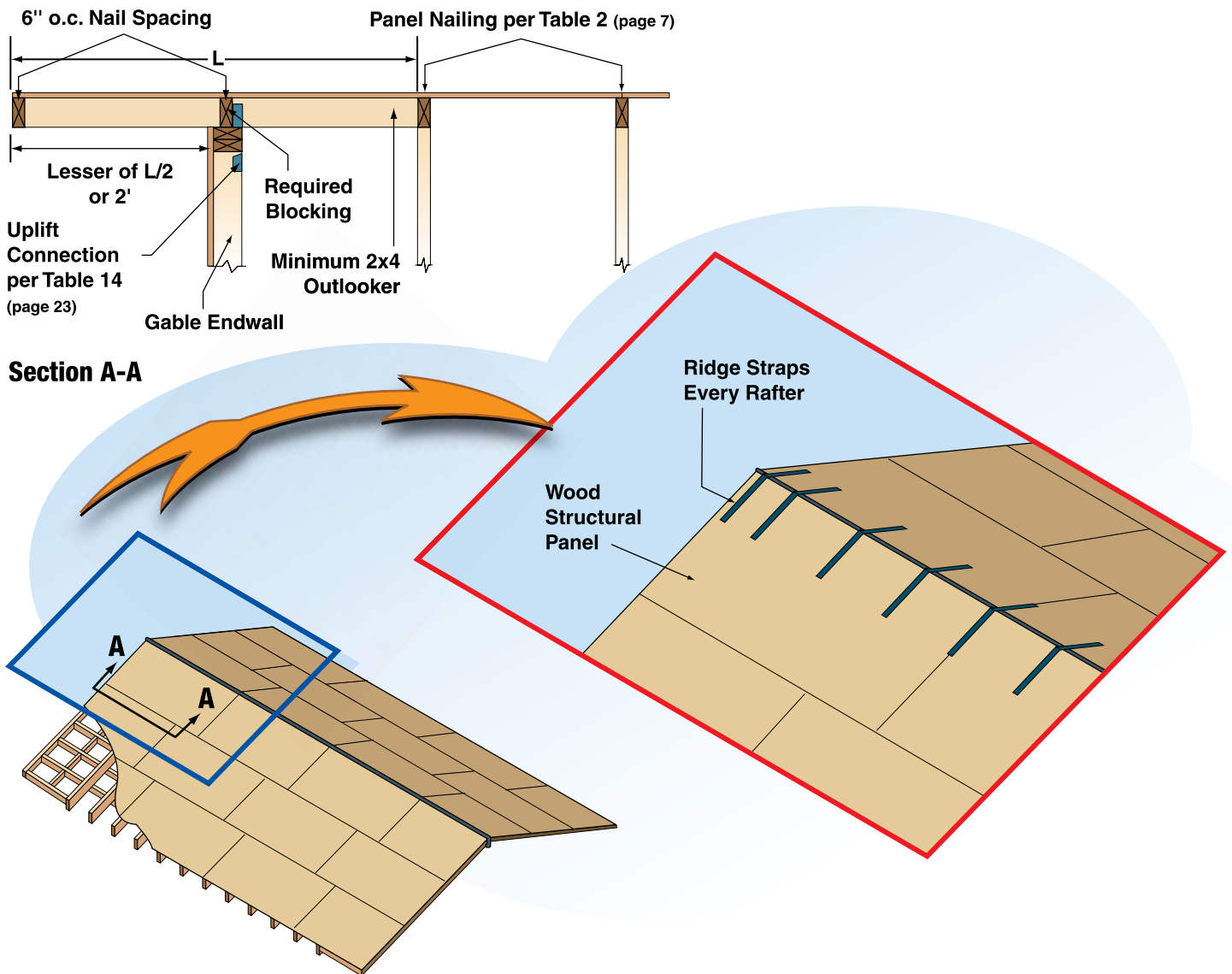

Figure 20. Rafter Outlooker Details

Table 14. Outlooker Connections at Gravity Non-Loadbearing Walls

Outlooker Spacing	Outlooker Uplift (lb.)	Stud Height (ft.)						
		8	10	12	14	16	18	20
		Lateral (lb.)						
12" o.c.	209	74	89	102	115	127	139	150
16" o.c.	279	99	119	136	153	169	185	200
24" o.c.	418	148	178	204	230	254	278	300

5.3 WOOD I-JOIST ROOF SYSTEMS

Wood I-joist roof systems shall comply with requirements set forth in the manufacturer's code evaluation report. I-joist roof framing members shall be connected to exterior walls in accordance with Table 12 (page 21) and to the ridge beam in accordance with Table 13.

5.4 WOOD ROOF TRUSS SYSTEMS

Wood roof truss systems shall be designed, manufactured, and installed in accordance *ANSI/TPI 1 National Design Standard for Metal Plate Connected Wood Truss Construction*, the truss design drawings, and/or the manufacturer's code evaluation report. Roof trusses shall be connected to exterior walls in accordance with Table 12 (page 21).

5.5 ROOF SHEATHING

Roofs shall be sheathed with a minimum of 3/8" wood structural panel sheathing and be attached in accordance with Table 2 (page 7).

5.6 ROOF BRACING ENDWALL

Blocking and connections shall be provided at panel edges perpendicular to roof framing members in the first two truss or joist spaces and shall be spaced at a maximum of 4 feet on center. Nailing requirements are given in Table 2 (page 7). See Figure 9.

- **EXCEPTION:** When an attic floor or ceiling diaphragm is used to brace the gable endwall or when a hip roof system is used, additional roof diaphragm blocking is not required.

Glossary of Terms

The following definitions describe some of the terminology used in this Guide.

Aspect Ratio. The ratio of building length dimension (L) to the building width dimension (W).

Blocking. Wood member which provides edge support for sheathing or provides load path continuity such as below offset walls, offset floors, and between cantilever members.

Bottom Plate. A horizontal wood member attached to the bottom of a frame wall and connected to floor joists, girders, or other members.

Cantilever. The unsupported portion of a beam which extends beyond a support.

Ceiling Joist. A horizontal structural framing member which supports ceiling and/or attic loads.

Cladding. Exterior structural elements that receive loads normal to their surface.

Continuous Load Path. The interconnection of all framing elements of the lateral and vertical force resisting systems, which transfers lateral and vertical forces to the foundation.

Endwall. The exterior wall of a building perpendicular to the roof ridge and parallel to roof rafters or trusses.

Floor Joist. A horizontal structural framing member which supports floor loads.

Foundation Wall. The vertical structural wall unit attached to the foundation which supports vertical and lateral loads.

Gable. The triangular portion of the endwall beneath a dual-slope, pitched, or mono-slope roof.

Header. A beam used over wall or roof openings to carry loads across the opening.

Hold Down. A connector device used to provide overturning restraint by resisting uplift of the chords of shear walls. (See Figures 18a and 18b)

I-Joist. A structural member manufactured using sawn or structural composite lumber flanges and structural panel webs, bonded together with exterior exposure adhesives, forming an "I" cross-sectional shape.

Jack Rafter. A rafter that spans from a hip or valley rafter or beam to a wall plate or ridge, respectively.

Jack Studs. A vertical structural element which does not span the full height of the wall and supports vertical loads.

Mean Roof Height. The distance from average grade to the average roof elevation (See Figure 2).

Mono-slope Roof. A roof with constant slope in one direction.

Perforated Shear Wall. A shear wall composed of shear wall segments with overturning restraint provided at each end of the shear wall, but which does not require special connections for force transfer around wall openings (See Tables 10-11 on pages 18 and 19).

Pitched Roof. A roof with one or more sloping surfaces.

Rafter. A horizontal or sloped structural framing member that supports roof loads (See Figure 19).

Rafter Overhang (Eave). The horizontal projection of a rafter measured from the outside face of the wall to the outside edge of the rafter.

Rafter Tie. A structural framing member located in the lower third of the attic space that ties rafters together to resist thrust from gravity loads on the roof.

Rake Overhang. The horizontal projection of the roof measured from the outside face of the gable endwall to the outside edge of the roof (See Figure 16).

Ridge. The horizontal line formed by the joining of the top edges of two sloping roof surfaces.

Ridge Beam. A structural member used at the ridge of a roof to support the ends of roof rafters and transfer roof loads to supports.

Ridge Board. A non-structural member used at the ridge of a roof to provide a common nailing surface and point of bearing for opposing roof rafters.

Ridge Strap. A metal connector that fastens opposing rafters together to resist roof suction loads at the ridge.

Roof Span. The distance between the outside of exterior walls supporting the roof/ceiling or truss assembly.

Setback. The offset distance of a wall on a floor system, measured from the support towards mid-span of the floor system.

Shear Wall. A vertical structural unit composed of one or more shear wall segments in one plane.

Shear Wall Line. Shear walls which are not offset by more than 4 feet horizontally from any other shear wall may be considered in the same shear wall line.

Shear Wall Plan Offset. The distance from a shear wall to the nearest parallel shear wall.

Sheathing. The structural covering used directly over framing members, such as studs, joists, or rafters, which transfers perpendicular loads to the framing material.

Sill Plate. A horizontal wood member anchored to the foundation and supporting floor joists.

Slab-On-Grade. The concrete slab that serves as the floor for the first story, upon which the first story framed walls are attached.

Span. The distance between face of supports, plus $\frac{1}{2}$ the required bearing length at each end.

Story. The portion of a structure included between the upper surface of a floor and the upper surface of the floor or roof next above.

Stud. Vertical structural element of wall assemblies which transfers vertical and/or lateral loads.

Top Plate(s). A horizontal wood member(s) attached to the top of a frame wall and supporting trusses, I-joists, rafters, floor joists, ceiling joists, or other members.

Truss. An engineered structural component, assembled from wood members, metal connector plates, or other mechanical fasteners, designed to carry its own weight and superimposed design loads. The truss members form a semi-rigid structural framework and are assembled such that the members form triangles. Variations include metal web trusses, metal tube trusses, and plywood gusset trusses.

Vertical Floor Offset. The distance between two adjoining floor assemblies which do not lie in the same horizontal plane.

Wind Exposure

Exposure B. Urban and suburban areas, wooded areas, or other terrain with numerous closely spaced obstructions having the size of single family dwellings or larger. Exposure B shall be assumed unless the site meets the definition of another type exposure.

Exposure C. Open terrain with scattered obstructions including surface undulations or other irregularities having heights generally less than 30 feet extending more than 1500 feet from the building site in any full quadrant. Exposure C extends into adjacent Exposure B type terrain in the downwind direction for a distance of 1500 feet or 10 times the height of the building or structure, whichever is greater. This category includes open country and grasslands, and open water exposure of less than 1 mile.

Exposure D. Flat unobstructed areas exposed to wind flowing over open water for a distance of at least 1 mile. This exposure shall apply only to those buildings and other structures exposed to the wind coming from over the water. Exposure D extends inland from the shoreline a distance of 1500 feet or 10 times the height of the building or structure, whichever is greater.

Window Sill Plate. A horizontal framing member below an opening.

Checklist

1.1 SCOPE

Wind Speed (3-second gust)90 mph _____
 Wind Exposure Category B _____

1.2 APPLICABILITY

Number of Stories (Figure 2) _____ stories ≤ 2 stories _____
 Roof Pitch (Figure 19) _____ ≤ 12:12 _____
 Mean Roof Height (Figure 2) _____ ft. ≤ 33' _____
 Building Width, W (Figure 4) _____ ft. ≤ 80' _____
 Building Length, L (Figure 4) _____ ft. ≤ 80' _____
 Building Aspect Ratio (L/W) (Figure 4) _____ ≤ 3.0:1 _____

1.3 FRAMING CONNECTIONS

General compliance with framing connections? (Table 2) _____

2.1 ANCHORAGE TO FOUNDATION

Type of Foundation (Figure 5) _____
 Foundation Anchorage
 Proprietary Connectors
 Uplift (Table 3) U = _____ plf _____
 Lateral (Table 3) L = _____ plf _____
 Shear (Table 3) S = _____ plf _____
 5/8" Anchor Bolts
 Bolt Spacing (Table 4) _____ in. _____
 Bolt Embedment (Figure 5) _____ in. _____
 Washer Size (Figure 5) _____ in. x _____ in. x _____ in. thick _____

3.1 FLOORS

Floor framing member spans checked? (IRC or WFCM) _____
 Maximum Floor Opening Dimension (Figure 6) _____ ft. ≤ 12' _____
 Maximum Floor Joist Setbacks
 Supporting Loadbearing Walls or Shearwall (Figure 7) _____ ft. ≤ d _____
 Maximum Cantilevered Floor Joists
 Supporting Loadbearing Walls or Shearwall (Figure 8) _____ ft. ≤ d _____
 Floor Bracing at Endwalls (Figure 9) _____
 Floor Sheathing Type (IRC or WFCM) _____
 Floor Sheathing Thickness (IRC or WFCM) _____ in. _____
 Floor Sheathing Fastening (Table 2) _____

4.1 WALLS

Wall Height
 Loadbearing Walls (Figure 10) _____ ft. ≤ 10' _____
 Non-Loadbearing Walls (Figure 10) _____ ft. ≤ 20' _____
 Wall Stud Spacing (Figure 10) _____ in. ≤ 24" o.c. _____
 Wall Story Offsets (Figures 7-8) _____ in. ≤ d _____

4.2 EXTERIOR WALLS

Wood Studs
 Loadbearing Walls (Table 5) 2x _____ - _____ ft. _____ in. _____
 Non-Loadbearing Walls (Table 5) 2x _____ - _____ ft. _____ in. _____

90 MPH EXPOSURE B WIND ZONE

Bracing Gable End Walls			
WSP Attic Floor Length.....	(Figure 11).....	___ ft. \geq W/3	___
Gypsum Ceiling Length.....	(Figure 11).....	___ ft. \geq 0.6W	___
Double Top Plate			
Splice Length.....	(Figure 13).....	___ ft.	___
Splice Connection (no. of 16d common nails)	(Table 6).....	___	___
Loadbearing Wall Connections			
Uplift. (proprietary connectors).....	(Table 7).....	U = ___ lb.	___
Lateral (no. of 16d common nails)	(Table 7).....	___	___
Non-Loadbearing Wall Connections			
Uplift. (proprietary connectors).....	(Table 8).....	U = ___ lb.	___
Lateral (no. of 16d common nails)	(Table 8).....	___	___
Wall Openings			
Header Spans.....	(Table 9).....	___ ft. ___ in. \leq 11'	___
Sill Plate Spans.....	(Table 9).....	___ ft. ___ in. \leq 12'	___
Full Height Studs (no. of studs).....	(Table 9).....	___	___
Connections at each end of header or sill			
Uplift. (proprietary connectors).....	(Table 9).....	___ lb.	___
Lateral (proprietary connectors)	(Table 9).....	___ lb.	___
Wall Sheathing			
Minimum Building Dimension, W			
Sheathing Type.....	(Table 10).....	___	___
Edge Nail Spacing.....	(Table 10).....	___ in.	___
Field Nail Spacing.....	(Table 10).....	___ in.	___
Shear Connection (no. of 16d common nails)	(Table 10).....	___	___
Hold Down Capacity.....	(Table 10).....	___ lb.	___
Percent Full-Height Sheathing.....	(Table 10).....	___%	___
Maximum Building Dimension, L			
Sheathing Type.....	(Table 11).....	___	___
Edge Nail Spacing.....	(Table 11).....	___ in.	___
Field Nail Spacing.....	(Table 11).....	___ in.	___
Shear Connection (no. of 16d common nails)	(Table 11).....	___	___
Hold Down Capacity.....	(Table 11).....	___ lb.	___
Percent Full-Height Sheathing.....	(Table 11).....	___%	___
Wall Cladding			
Rated for Wind Speed?.....	___	___

5.1 ROOFS

Roof framing member spans checked?.....	(IRC or WFCM).....	___	___
Roof Overhang.....	(Figure 19).....	___ ft. \leq 2' or L/3	___
Truss, I-Joist, or Rafter Connections at Loadbearing Walls			
Proprietary Connectors			
Uplift.....	(Table 12).....	U = ___ lb.	___
Lateral.....	(Table 12).....	L = ___ lb.	___
Shear.....	(Table 12).....	S = ___ lb.	___
Ridge Strap Connections – Tension	(Table 13).....	T = ___ plf	___
Gable Rafter Outlooker	(Figure 20).....	___ ft. \leq 2' or L/2	___
Outlooker Connections at Non-Loadbearing Walls			
Proprietary Connectors			
Uplift.....	(Table 14).....	U = ___ lb.	___
Lateral.....	(Table 14).....	L = ___ lb.	___
Roof Sheathing Type.....	(IRC or WFCM).....	___	___
Roof Sheathing Thickness.....	___ in. \geq 3/8" wsp	___	___
Roof Sheathing Fastening.....	(Table 2).....	___	___

American Wood Council

Engineered and Traditional Wood Products

AWC Mission Statement

To increase the use of wood by assuring the broad regulatory acceptance of wood products, developing design tools and guidelines for wood construction, and influencing the development of public policies affecting the use of wood products.

**American Forest & Paper Association
American Wood Council
1111 19th Street, NW
Suite 800
Washington, DC 20036
www.awc.org
awcinfo@afandpa.org**

**America's Forest & Paper People®
Improving Tomorrow's Environment Today®**

A F & P A®

