



Designation: **D 638 – 02a3**

Standard Test Method for Tensile Properties of Plastics¹

This standard is issued under the fixed designation D 638; the number immediately following the designation indicates the year of original adoption or, in the case of revision, the year of last revision. A number in parentheses indicates the year of last reappraisal. A superscript epsilon (ϵ) indicates an editorial change since the last revision or reappraisal.

This standard has been approved for use by agencies of the Department of Defense.

1. Scope*

1.1 This test method covers the determination of the tensile properties of unreinforced and reinforced plastics in the form of standard dumbbell-shaped test specimens when tested under defined conditions of pretreatment, temperature, humidity, and testing machine speed.

1.2 This test method can be used for testing materials of any thickness up to 14 mm (0.55 in.). However, for testing specimens in the form of thin sheeting, including film less than 1.0 mm (0.04 in.) in thickness, Test Methods D 882 is the preferred test method. Materials with a thickness greater than 14 mm (0.55 in.) must be reduced by machining.

1.3 This test method includes the option of determining Poisson's ratio at room temperature.

NOTE 1—This test method and ISO 527-1 are technically equivalent.

NOTE 2—This test method is not intended to cover precise physical procedures. It is recognized that the constant rate of crosshead movement type of test leaves much to be desired from a theoretical standpoint, that wide differences may exist between rate of crosshead movement and rate of strain between gage marks on the specimen, and that the testing speeds specified disguise important effects characteristic of materials in the plastic state. Further, it is realized that variations in the thicknesses of test specimens, which are permitted by these procedures, produce variations in the surface-volume ratios of such specimens, and that these variations may influence the test results. Hence, where directly comparable results are desired, all samples should be of equal thickness. Special additional tests should be used where more precise physical data are needed.

NOTE 3—This test method may be used for testing phenolic molded resin or laminated materials. However, where these materials are used as electrical insulation, such materials should be tested in accordance with Test Methods D 229 and Test Method D 651.

NOTE 4—For tensile properties of resin-matrix composites reinforced with oriented continuous or discontinuous high modulus $>20\text{-GPa}$ ($>3.0 \times 10^6\text{-psi}$) fibers, tests shall be made in accordance with Test Method D 3039/D 3039M.

1.4 Test data obtained by this test method are relevant and appropriate for use in engineering design.

1.5 The values stated in SI units are to be regarded as the standard. The values given in parentheses brackets are for information only.

1.6 *This standard does not purport to address all of the safety concerns, if any, associated with its use. It is the responsibility of the user of this standard to establish appropriate safety and health practices and determine the applicability of regulatory limitations prior to use.*

¹ This test method is under the jurisdiction of ASTM Committee D20 on Plastics and is the direct responsibility of Subcommittee D20.10 on Mechanical Properties. Current edition approved November 10, 2002; December 1, 2003. Published January 2003. Originally approved in 1941. Last previous edition approved in 2002 as D 638 – 02a.

*A Summary of Changes section appears at the end of this standard.

2. Referenced Documents

2.1 ASTM Standards:²

- D 229 Test Methods for Rigid Sheet and Plate Materials Used for Electrical Insulation
- D 412 Test Methods for Vulcanized Rubber and Thermoplastic Elastomers—Tension
- D 618 Practice for Conditioning Plastics for Testing
- D 651 Test Method for Tensile Strength of Molded Electrical Insulating Materials
- D 882 Test Methods for Tensile Properties of Thin Plastic Sheeting
- D 883 Terminology Relating to Plastics
- D 1822 Test Method for Tensile-Impact Energy to Break Plastics and Electrical Insulating Materials
- D 3039/D 3039M Test Method for Tensile Properties of Polymer Matrix Composite Materials
- D 4000 Classification System for Specifying Plastic Materials
- D 4066 Classification System for Nylon Injection and Extrusion Materials
- D 5947 Test Methods for Physical Dimensions of Solid Plastic Specimens
- E 4 Practices for Force Verification of Testing Machines
- E 83 Practice for Verification and Classification of Extensometer
- E 132 Test Method for Poisson's Ratio at Room Temperature
- E 691 Practice for Conducting an Interlaboratory Study to Determine the Precision of a Test Method

2.2 ISO Standard:³

- ISO 527-1 Determination of Tensile Properties

3. Terminology

- 3.1 *Definitions*—Definitions of terms applying to this test method appear in Terminology D 883 and Annex A2.

4. Significance and Use

4.1 This test method is designed to produce tensile property data for the control and specification of plastic materials. These data are also useful for qualitative characterization and for research and development. For many materials, there may be a specification that requires the use of this test method, but with some procedural modifications that take precedence when adhering to the specification. Therefore, it is advisable to refer to that material specification before using this test method. Table 1 in Classification D 4000 lists the ASTM materials standards that currently exist.

4.2 Tensile properties may vary with specimen preparation and with speed and environment of testing. Consequently, where precise comparative results are desired, these factors must be carefully controlled.

4.2.1 It is realized that a material cannot be tested without also testing the method of preparation of that material. Hence, when comparative tests of materials per se are desired, the greatest care must be exercised to ensure that all samples are prepared in exactly the same way, unless the test is to include the effects of sample preparation. Similarly, for referee purposes or comparisons within any given series of specimens, care must be taken to secure the maximum degree of uniformity in details of preparation, treatment, and handling.

4.3 Tensile properties may provide useful data for plastics engineering design purposes. However, because of the high degree of sensitivity exhibited by many plastics to rate of straining and environmental conditions, data obtained by this test method cannot be considered valid for applications involving load-time scales or environments widely different from those of this test method. In cases of such dissimilarity, no reliable estimation of the limit of usefulness can be made for most plastics. This sensitivity to rate of straining and environment necessitates testing over a broad load-time scale (including impact and creep) and range of environmental conditions if tensile properties are to suffice for engineering design purposes.

NOTE 5—Since the existence of a true elastic limit in plastics (as in many other organic materials and in many metals) is debatable, the propriety of applying the term “elastic modulus” in its quoted, generally accepted definition to describe the “stiffness” or “rigidity” of a plastic has been seriously questioned. The exact stress-strain characteristics of plastic materials are highly dependent on such factors as rate of application of stress, temperature, previous history of specimen, etc. However, stress-strain curves for plastics, determined as described in this test method, almost always show a linear region at low stresses, and a straight line drawn tangent to this portion of the curve permits calculation of an elastic modulus of the usually defined type. Such a constant is useful if its arbitrary nature and dependence on time, temperature, and similar factors are realized.

4.4 *Poisson's Ratio*—When uniaxial tensile force is applied to a solid, the solid stretches in the direction of the applied force (axially), but it also contracts in both dimensions lateral to the applied force. If the solid is homogeneous and isotropic, and the material remains elastic under the action of the applied force, the lateral strain bears a constant relationship to the axial strain. This constant, called Poisson's ratio, is defined as the negative ratio of the transverse (negative) to axial strain under uniaxial stress.

4.4.1 Poisson's ratio is used for the design of structures in which all dimensional changes resulting from the application of force need to be taken into account and in the application of the generalized theory of elasticity to structural analysis.

² For referenced ASTM standards, visit the ASTM website, www.astm.org, or contact ASTM Customer Service at service@astm.org. For *Annual Book of ASTM Standards*, Vol 10.01, volume information, refer to the standard's Document Summary page on the ASTM website.

Annual Book of ASTM

³ Available from American National Standards, Vol 09-01, Institute (ANSI), 25 W. 43rd St., 4th Floor, New York, NY 10036.

NOTE 6—The accuracy of the determination of Poisson's ratio is usually limited by the accuracy of the transverse strain measurements because the percentage errors in these measurements are usually greater than in the axial strain measurements. Since a ratio rather than an absolute quantity is measured, it is only necessary to know accurately the relative value of the calibration factors of the extensometers. Also, in general, the value of the applied loads need not be known accurately.

5. Apparatus

5.1 *Testing Machine*—A testing machine of the constant-rate-of-crosshead-movement type and comprising essentially the following:

5.1.1 *Fixed Member*—A fixed or essentially stationary member carrying one grip.

5.1.2 *Movable Member*—A movable member carrying a second grip.

5.1.3 *Grips*—Grips for holding the test specimen between the fixed member and the movable member of the testing machine can be either the fixed or self-aligning type.

5.1.3.1 Fixed grips are rigidly attached to the fixed and movable members of the testing machine. When this type of grip is used extreme care should be taken to ensure that the test specimen is inserted and clamped so that the long axis of the test specimen coincides with the direction of pull through the center line of the grip assembly.

5.1.3.2 Self-aligning grips are attached to the fixed and movable members of the testing machine in such a manner that they will move freely into alignment as soon as any load is applied so that the long axis of the test specimen will coincide with the direction of the applied pull through the center line of the grip assembly. The specimens should be aligned as perfectly as possible with the direction of pull so that no rotary motion that may induce slippage will occur in the grips; there is a limit to the amount of misalignment self-aligning grips will accommodate.

5.1.3.3 The test specimen shall be held in such a way that slippage relative to the grips is prevented insofar as possible. Grip surfaces that are deeply scored or serrated with a pattern similar to those of a coarse single-cut file, serrations about 2.4 mm—(0.09 in.) apart and about 1.6 mm—(0.06 in.) deep, have been found satisfactory for most thermoplastics. Finer serrations have been found to be more satisfactory for harder plastics, such as the thermosetting materials. The serrations should be kept clean and sharp. Breaking in the grips may occur at times, even when deep serrations or abraded specimen surfaces are used; other techniques must be used in these cases. Other techniques that have been found useful, particularly with smooth-faced grips, are abrading that portion of the surface of the specimen that will be in the grips, and interposing thin pieces of abrasive cloth, abrasive paper, or plastic, or rubber-coated fabric, commonly called hospital sheeting, between the specimen and the grip surface. No. 80 double-sided abrasive paper has been found effective in many cases. An open-mesh fabric, in which the threads are coated with abrasive, has also been effective. Reducing the cross-sectional area of the specimen may also be effective. The use of special types of grips is sometimes necessary to eliminate slippage and breakage in the grips.

5.1.4 *Drive Mechanism*—A drive mechanism for imparting to the movable member a uniform, controlled velocity with respect to the stationary member, with this velocity to be regulated as specified in Section 8.

5.1.5 *Load Indicator*—A suitable load-indicating mechanism capable of showing the total tensile load carried by the test specimen when held by the grips. This mechanism shall be essentially free of inertia lag at the specified rate of testing and shall indicate the load with an accuracy of $\pm 1\%$ of the indicated value, or better. The accuracy of the testing machine shall be verified in accordance with Practices E 4.

NOTE 7—Experience has shown that many testing machines now in use are incapable of maintaining accuracy for as long as the periods between inspection recommended in Practices E 4. Hence, it is recommended that each machine be studied individually and verified as often as may be found necessary. It frequently will be necessary to perform this function daily.

5.1.6 The fixed member, movable member, drive mechanism, and grips shall be constructed of such materials and in such proportions that the total elastic longitudinal strain of the system constituted by these parts does not exceed 1 % of the total longitudinal strain between the two gage marks on the test specimen at any time during the test and at any load up to the rated capacity of the machine.

5.1.7 *Crosshead Extension Indicator*— A suitable extension indicating mechanism capable of showing the amount of change in the separation of the grips, that is, crosshead movement. This mechanism shall be essentially free of inertial lag at the specified rate of testing and shall indicate the crosshead movement with an accuracy of $\pm 10\%$ of the indicated value.

5.2 *Extension Indicator (extensometer)* —A suitable instrument shall be used for determining the distance between two designated points within the gage length of the test specimen as the specimen is stretched. For referee purposes, the extensometer must be set at the full gage length of the specimen, as shown in Fig. 1. It is desirable, but not essential, that this instrument automatically record this distance, or any change in it, as a function of the load on the test specimen or of the elapsed time from the start of the test, or both. If only the latter is obtained, load-time data must also be taken. This instrument shall be essentially free of inertia at the specified speed of testing. Extensometers shall be classified and their calibration periodically verified in accordance with Practice E 83.

5.2.1 *Modulus-of-Elasticity Measurements*— For modulus-of-elasticity measurements, an extensometer with a maximum strain error of 0.0002 mm/mm—(in./in.) that automatically and continuously records shall be used. An extensometer classified by Practice E 83 as fulfilling the requirements of a B-2 classification within the range of use for modulus measurements meets this requirement.

5.2.2 *Low-Extension Measurements*—For elongation-at-yield and low-extension measurements (nominally 20 % or less), the

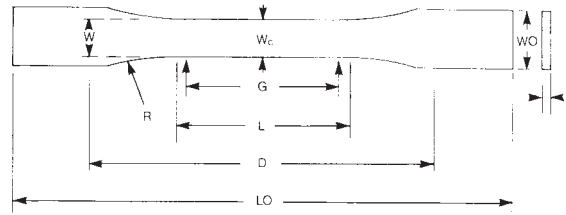

TYPES I, II, III & IV

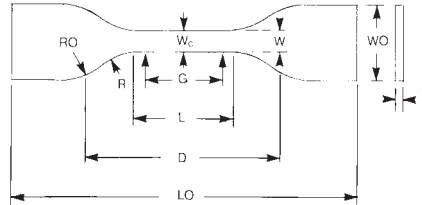

TYPE IV

Specimen Dimensions for Thickness, *T*, mm [in.]^A

Dimensions (see drawings)	7 [0.28] or under		Over 7 to 14 [0.28 to 0.55], incl	4 [0.16] or under		Tolerances
	Type I	Type II	Type III	Type IV ^B	Type V ^{C,D}	
<i>W</i> —Width of narrow section ^{E,F}	13 [0.50]	6 [0.25]	19 [0.75]	6 [0.25]	3.18 [0.125]	±0.5 [±0.02] ^{B,C}
<i>L</i> —Length of narrow section	57 [2.25]	57 [2.25]	57 [2.25]	33 [1.30]	9.53 [0.375]	±0.5 [±0.02] ^C
<i>WO</i> —Width overall, min ^G	19 [0.75]	19 [0.75]	29 [1.13]	19 [0.75]	...	+ 6.4 [+ 0.25]
<i>WO</i> —Width overall, min ^G	9.53 [0.375]	+ 3.18 [+ 0.125]
<i>LO</i> —Length overall, min ^H	165 [6.5]	183 [7.2]	246 [9.7]	115 [4.5]	63.5 [2.5]	no max [no max]
<i>G</i> —Gage length ^I	50 [2.00]	50 [2.00]	50 [2.00]	...	7.62 [0.300]	±0.25 [±0.010] ^C
<i>G</i> —Gage length ^I	25 [1.00]	...	±0.13 [±0.005]
<i>D</i> —Distance between grips	115 [4.5]	135 [5.3]	115 [4.5]	65 [2.5] ^J	25.4 [1.0]	±5 [±0.2]
<i>R</i> —Radius of fillet	76 [3.00]	76 [3.00]	76 [3.00]	14 [0.56]	12.7 [0.5]	±1 [±0.04] ^C
<i>RO</i> —Outer radius (Type IV)	25 [1.00]	...	±1 [±0.04]

^A Thickness, *T*, shall be 3.2 ± 0.4 mm [0.13 ± 0.02 in.] for all types of molded specimens, and for other Types I and II specimens where possible. If specimens are machined from sheets or plates, thickness, *T*, may be the thickness of the sheet or plate provided this does not exceed the range stated for the intended specimen type. For sheets of nominal thickness greater than 14 mm [0.55 in.] the specimens shall be machined to 14 ± 0.4 mm [0.55 ± 0.02 in.] in thickness, for use with the Type III specimen. For sheets of nominal thickness between 14 and 51 mm [0.55 and 2 in.] approximately equal amounts shall be machined from each surface. For thicker sheets both surfaces of the specimen shall be machined, and the location of the specimen with reference to the original thickness of the sheet shall be noted. Tolerances on thickness less than 14 mm [0.55 in.] shall be those standard for the grade of material tested.

^B For the Type IV specimen, the internal width of the narrow section of the die shall be 6.00 ± 0.05 mm [0.250 ± 0.002 in.]. The dimensions are essentially those of Die C in Test Methods D 412.

^C The Type V specimen shall be machined or die cut to the dimensions shown, or molded in a mold whose cavity has these dimensions. The dimensions shall be:

- W* = 3.18 ± 0.03 mm [0.125 ± 0.001 in.],
- L* = 9.53 ± 0.08 mm [0.375 ± 0.003 in.],
- G* = 7.62 ± 0.02 mm [0.300 ± 0.001 in.], and
- R* = 12.7 ± 0.08 mm [0.500 ± 0.003 in.].

The other tolerances are those in the table.

^D Supporting data on the introduction of the L specimen of Test Method D 1822 as the Type V specimen are available from ASTM Headquarters. Request RR:D20-1038.

^E The width at the center *W_c* shall be +0.00 mm, -0.10 mm [+0.00 in., -0.004 in.] compared with width *W* at other parts of the reduced section. Any reduction in *W* at the center shall be gradual, equally on each side so that no abrupt changes in dimension result.

^F For molded specimens, a draft of not over 0.13 mm [0.005 in.] may be allowed for either Type I or II specimens 3.2 mm [0.13 in.] in thickness, and this should be taken into account when calculating width of the specimen. Thus a typical section of a molded Type I specimen, having the maximum allowable draft, could be as follows:

^G Overall widths greater than the minimum indicated may be desirable for some materials in order to avoid breaking in the grips.

^H Overall lengths greater than the minimum indicated may be desirable either to avoid breaking in the grips or to satisfy special test requirements.

^I Test marks or initial extensometer span.

^J When self-tightening grips are used, for highly extensible polymers, the distance between grips will depend upon the types of grips used and may not be critical if maintained uniform once chosen.

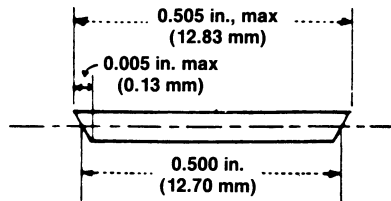

FIG. 1 Tension Test Specimens for Sheet, Plate, and Molded Plastics

same above extensometer, attenuated to 20 % extension, may be used. In any case, the extensometer system must meet at least Class C (Practice E 83) requirements, which include a fixed strain error of 0.001 strain or ±1.0 % of the indicated strain, whichever is greater.

5.2.3 High-Extension Measurements—For making measurements at elongations greater than 20 %, measuring techniques with

error no greater than $\pm 10\%$ of the measured value are acceptable.

5.2.4 *Poisson's Ratio*—Bi-axial extensometer or axial and transverse extensometers capable of recording axial strain and transverse strain simultaneously. The extensometers shall be capable of measuring the change in strains with an accuracy of 1% of the relevant value or better.

NOTE 8—Strain gages can be used as an alternative method to measure axial and transverse strain; however, proper techniques for mounting strain gages are crucial to obtaining accurate data. Consult strain gage suppliers for instruction and training in these special techniques.

5.3 *Micrometers*—~~Suitable micrometers~~—Apparatus for measuring the width and thickness of the test specimen to an incremental discrimination of at least 0.025 mm (0.001 in.) should be used. All width and thickness measurements of rigid and semirigid plastics may be measured shall comply with a hand micrometer with ratchet. A suitable instrument for measuring the thickness requirements of nonrigid test specimens shall have: (1) a contact measuring pressure of 25 ± 2.5 kPa (3.6 ± 0.36 psi), (2) a movable circular contact foot 6.35 ± 0.025 mm (0.250 ± 0.001 in.) in diameter, and (3) a lower fixed anvil large enough to extend beyond the contact foot in all directions and being parallel to the contact foot within 0.005 mm (0.0002 in.) over the entire foot area. Flatness of the foot and anvil shall conform to Test Method D 5947.

5.3.1 An optional instrument equipped with a circular contact foot 15.88 ± 0.08 mm (0.625 ± 0.003 in.) in diameter is recommended for thickness measuring of process samples or larger specimens at least 15.88 mm in minimum width.

6. Test Specimens

6.1 *Sheet, Plate, and Molded Plastics* :

6.1.1 *Rigid and Semirigid Plastics*—The test specimen shall conform to the dimensions shown in Fig. 1. The Type I specimen is the preferred specimen and shall be used where sufficient material having a thickness of 7 mm ($[0.28$ in.]) or less is available. The Type II specimen may be used when a material does not break in the narrow section with the preferred Type I specimen. The Type V specimen shall be used where only limited material having a thickness of 4 mm ($[0.16$ in.]) or less is available for evaluation, or where a large number of specimens are to be exposed in a limited space (thermal and environmental stability tests, etc.). The Type IV specimen should be used when direct comparisons are required between materials in different rigidity cases (that is, nonrigid and semirigid). The Type III specimen must be used for all materials with a thickness of greater than 7 mm ($[0.28$ in.]) but not more than 14 mm ($[0.55$ in.]).

6.1.2 *Nonrigid Plastics*—The test specimen shall conform to the dimensions shown in Fig. 1. The Type IV specimen shall be used for testing nonrigid plastics with a thickness of 4 mm ($[0.16$ in.]) or less. The Type III specimen must be used for all materials with a thickness greater than 7 mm ($[0.28$ in.]) but not more than 14 mm ($[0.55$ in.]).

6.1.3 *Reinforced Composites*—The test specimen for reinforced composites, including highly orthotropic laminates, shall conform to the dimensions of the Type I specimen shown in Fig. 1.

6.1.4 *Preparation*—Test specimens shall be prepared by machining operations, or die cutting, from materials in sheet, plate, slab, or similar form. Materials thicker than 14 mm ($[0.55$ in.]) must be machined to 14 mm ($[0.55$ in.]) for use as Type III specimens. Specimens can also be prepared by molding the material to be tested.

NOTE 9—Test results have shown that for some materials such as glass cloth, SMC, and BMC laminates, other specimen types should be considered to ensure breakage within the gage length of the specimen, as mandated by 7.3.

NOTE 10—When preparing specimens from certain composite laminates such as woven roving, or glass cloth, care must be exercised in cutting the specimens parallel to the reinforcement. The reinforcement will be significantly weakened by cutting on a bias, resulting in lower laminate properties, unless testing of specimens in a direction other than parallel with the reinforcement constitutes a variable being studied.

NOTE 11—Specimens prepared by injection molding may have different tensile properties than specimens prepared by machining or die-cutting because of the orientation induced. This effect may be more pronounced in specimens with narrow sections.

6.2 *Rigid Tubes*—The test specimen for rigid tubes shall be as shown in Fig. 2. The length, L , shall be as shown in the table in Fig. 2. A groove shall be machined around the outside of the specimen at the center of its length so that the wall section after machining shall be 60% of the original nominal wall thickness. This groove shall consist of a straight section 57.2 mm ($[2.25$ in.]) in length with a radius of 76 mm ($(3$ in.) $[3$ in.]) at each end joining it to the outside diameter. Steel or brass plugs having diameters such that they will fit snugly inside the tube and having a length equal to the full jaw length plus 25 mm ($(1$ in.) $[1$ in.]) shall be placed in the ends of the specimens to prevent crushing. They can be located conveniently in the tube by separating and supporting them on a threaded metal rod. Details of plugs and test assembly are shown in Fig. 2.

6.3 *Rigid Rods*—The test specimen for rigid rods shall be as shown in Fig. 3. The length, L , shall be as shown in the table in Fig. 3. A groove shall be machined around the specimen at the center of its length so that the diameter of the machined portion shall be 60% of the original nominal diameter. This groove shall consist of a straight section 57.2 mm ($[2.25$ in.]) in length with a radius of 76 mm ($(3$ in.) $[3$ in.]) at each end joining it to the outside diameter.

6.4 All surfaces of the specimen shall be free of visible flaws, scratches, or imperfections. Marks left by coarse machining operations shall be carefully removed with a fine file or abrasive, and the filed surfaces shall then be smoothed with abrasive paper (No. 00 or finer). The finishing sanding strokes shall be made in a direction parallel to the long axis of the test specimen. All flash shall be removed from a molded specimen, taking great care not to disturb the molded surfaces. In machining a specimen, undercuts that would exceed the dimensional tolerances shown in Fig. 1 shall be scrupulously avoided. Care shall also be taken to avoid other common machining errors.

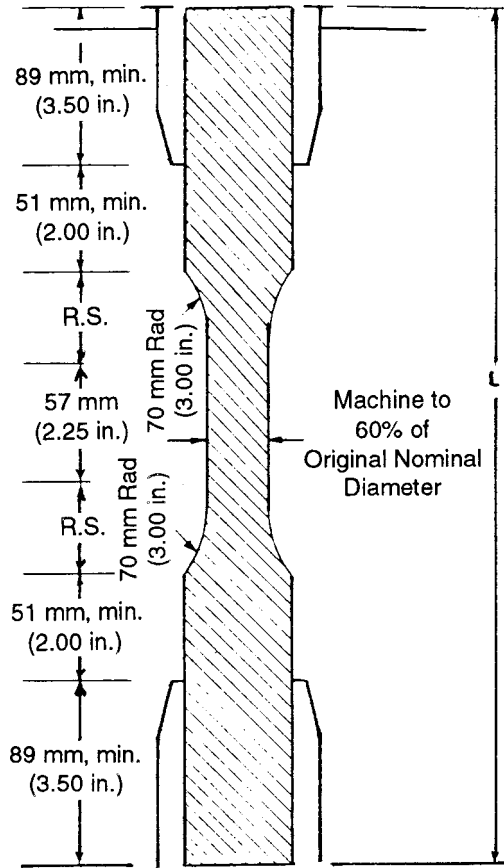

DIMENSIONS OF ROD SPECIMENS

Nominal Diameter	Length of Radial Sections, 2R.S.	Total Calculated Minimum Length of Specimen	Standard Length, L, of Specimen to Be Used for 89-mm-(3½-in.) Jaws ^A
mm-[in.]			
3.2 (1/8)	19.6 (0.773)	356 (14.02)	381 (15)
4.7 (1/16)	24.0 (0.946)	361 (14.20)	381 (15)
6.4 (1/4)	27.7 (1.091)	364 (14.34)	381 (15)
9.5 (3/8)	33.9 (1.333)	370 (14.58)	381 (15)
12.7 (1/2)	39.0 (1.536)	376 (14.79)	400 (15.75)
15.9 (5/8)	43.5 (1.714)	380 (14.96)	400 (15.75)
19.0 (3/4)	47.6 (1.873)	384 (15.12)	400 (15.75)
22.2 (7/8)	51.5 (2.019)	388 (15.27)	400 (15.75)
25.4 (1)	54.7 (2.154)	391 (15.40)	419 (16.5)
31.8 (1¼)	60.9 (2.398)	398 (15.65)	419 (16.5)
38.1 (1½)	66.4 (2.615)	403 (15.87)	419 (16.5)
42.5 (1¾)	71.4 (2.812)	408 (16.06)	419 (16.5)
50.8 (2)	76.0 (2.993)	412 (16.24)	432 (17)
50.8 [2]	76.0 [2.993]	412 [16.24]	432 [17]

^A For other jaws greater than 89 mm (3.5 in.), the standard length shall be increased by twice the length of the jaws minus 178 mm (7 in.). The standard length permits a slippage of approximately 6.4 to 12.7 mm (0.25 to 0.50 in.) in each jaw while maintaining the maximum length of the jaw grip.

FIG. 3 Diagram Showing Location of Rod Tension Test Specimen in Testing Machine

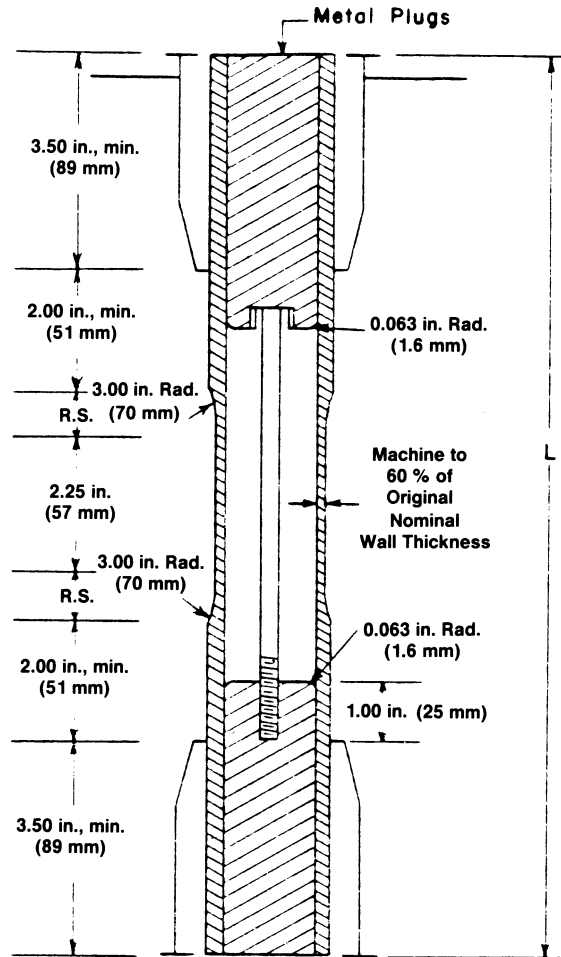

DIMENSIONS OF TUBE SPECIMENS

Nominal Wall Thickness	Length of Radial Sections, 2R.S.	Total Calculated Minimum Length of Specimen	Standard Length, L, of Specimen to Be Used for 89-mm { [3.5-in.] Jaws ^A
mm-([in.])			
0.79 (1/32)	13.9 (0.547)	350 (13.80)	381 (15)
0.79 (1/32)	13.9 [0.547]	350 [13.80]	381 [15]
1.2 (3/64)	17.0 (0.670)	354 (13.92)	381 (15)
1.2 (3/64)	17.0 [0.670]	354 [13.92]	381 [15]
1.6 (1/16)	19.6 (0.773)	356 (14.02)	381 (15)
1.6 (1/16)	19.6 [0.773]	356 [14.02]	381 [15]
2.4 (3/32)	24.0 (0.946)	361 (14.20)	381 (15)
2.4 (3/32)	24.0 [0.946]	361 [14.20]	381 [15]
3.2 (1/8)	27.7 (1.091)	364 (14.34)	381 (15)
3.2 (1/8)	27.7 [1.091]	364 [14.34]	381 [15]
4.8 (3/16)	33.9 (1.333)	370 (14.58)	381 (15)
4.8 (3/16)	33.9 [1.333]	370 [14.58]	381 [15]
6.4 (1/4)	39.0 (1.536)	376 (14.79)	400 (15.75)
6.4 (1/4)	39.0 [1.536]	376 [14.79]	400 [15.75]
7.9 (5/16)	43.5 (1.714)	380 (14.96)	400 (15.75)
7.9 (5/16)	43.5 [1.714]	380 [14.96]	400 [15.75]
9.5 (3/8)	47.6 (1.873)	384 (15.12)	400 (15.75)
9.5 (3/8)	47.6 [1.873]	384 [15.12]	400 [15.75]
11.1 (7/16)	51.3 (2.019)	388 (15.27)	400 (15.75)
11.1 (7/16)	51.3 [2.019]	388 [15.27]	400 [15.75]
12.7 (1/2)	54.7 (2.154)	391 (15.40)	419 (16.5)
12.7 (1/2)	54.7 [2.154]	391 [15.40]	419 [16.5]

^A For other jaws greater than 89 mm (3.5 in.), the standard length shall be increased by twice the length of the jaws minus 178 mm (7 in.). The standard length permits a slippage of approximately 6.4 to 12.7 mm (0.25 to 0.50 in.) in each jaw while maintaining the maximum length of the jaw grip.

FIG. 2 Diagram Showing Location of Tube Tension Test Specimens in Testing Machine

6.5 If it is necessary to place gage marks on the specimen, this shall be done with a wax crayon or India ink that will not affect the material being tested. Gage marks shall not be scratched, punched, or impressed on the specimen.

6.6 When testing materials that are suspected of anisotropy, duplicate sets of test specimens shall be prepared, having their long axes respectively parallel with, and normal to, the suspected direction of anisotropy.

7. Number of Test Specimens

7.1 Test at least five specimens for each sample in the case of isotropic materials.

7.2 Test ten specimens, five normal to, and five parallel with, the principle axis of anisotropy, for each sample in the case of anisotropic materials.

7.3 Discard specimens that break at some flaw, or that break outside of the narrow cross-sectional test section (Fig. 1, dimension “L”), and make retests, unless such flaws constitute a variable to be studied.

NOTE 12—Before testing, all transparent specimens should be inspected in a polariscope. Those which show atypical or concentrated strain patterns should be rejected, unless the effects of these residual strains constitute a variable to be studied.

8. Speed of Testing

8.1 Speed of testing shall be the relative rate of motion of the grips or test fixtures during the test. The rate of motion of the driven grip or fixture when the testing machine is running idle may be used, if it can be shown that the resulting speed of testing is within the limits of variation allowed.

8.2 Choose the speed of testing from Table 1. Determine this chosen speed of testing by the specification for the material being tested, or by agreement between those concerned. When the speed is not specified, use the lowest speed shown in Table 1 for the specimen geometry being used, which gives rupture within 1/2 to 5-min testing time.

8.3 Modulus determinations may be made at the speed selected for the other tensile properties when the recorder response and resolution are adequate.

8.4 The speed of testing for Poisson’s ratio determinations shall be made at the same speed selected for modulus determinations: 5 mm/min.

9. Conditioning

9.1 *Conditioning*—Condition the test specimens at $23 \pm 2^\circ\text{C}$ ($[73.4 \pm 3.6^\circ\text{F}]$) and $50 \pm 5\%$ relative humidity for not less than 40 h prior to test in accordance with Procedure A of Practice D 618, unless otherwise specified by contract or the relevant ASTM material specification. Reference pre-test conditioning, to settle disagreements, shall apply tolerances of $\pm 1^\circ\text{C}$ ($[1.8^\circ\text{F}]$) and $\pm 2\%$ relative humidity.

9.2 *Test Conditions*—Conduct the tests at $23 \pm 2^\circ\text{C}$ ($[73.4 \pm 3.6^\circ\text{F}]$) and $50 \pm 5\%$ relative humidity, unless otherwise specified by contract or the relevant ASTM material specification. Reference testing conditions, to settle disagreements, shall apply tolerances of $\pm 1^\circ\text{C}$ ($[1.8^\circ\text{F}]$) and $\pm 2\%$ relative humidity.

10. Procedure

10.1 Measure the width and thickness of rigid flat specimens (Fig. 1) with a suitable micrometer to the nearest 0.025 mm (0.001

TABLE 1 Designations for Speed of Testing^A

Classification ^B	Specimen Type	Speed of Testing, mm/min-([in./min])	Nominal Strain ^C Rate at Start of Test, mm/mm·min ([in./in.·min])
Rigid and Semirigid	I, II, III rods and tubes	5 (0.2) ± 25 %	0.1
		50 (2) ± 10 %	1
		500 (20) ± 10 %	10
	IV	5 (0.2) ± 25 %	0.15
		50 (2) ± 10 %	1.5
		500 (20) ± 10 %	15
V	1 (0.05) ± 25 %	0.1	
	10 (0.5) ± 25 %	1	
	100 (5) ± 25 %	10	
Nonrigid	III	50 (2) ± 10 %	1
		500 (20) ± 10 %	10
		500 (20) ± 10 %	15
IV	50 (2) ± 10 %	1.5	
	500 (20) ± 10 %	15	
	500 (20) ± 10 %	15	

^A Select the lowest speed that produces rupture in 1/2 to 5 min for the specimen geometry being used (see 8.2).

^B See Terminology D 883 for definitions.

^C The initial rate of straining cannot be calculated exactly for dumbbell-shaped specimens because of extension, both in the reduced section outside the gage length and in the fillets. This initial strain rate can be measured from the initial slope of the tensile strain-versus-time diagram.

in.) at several points along their narrow sections. Measure the thickness of nonrigid specimens (produced by a Type IV die) in the same manner with the required dial micrometer. Take the width of this each specimen as the distance between the cutting edges of the die in the narrow section. Measure the diameter of rod specimens, and the inside and outside diameters of tube specimens, to the nearest 0.025 mm (0.001 in.) at a minimum of two points 90° apart; make these measurements along [0.001 in.] using the groove for specimens so constructed. Use plugs applicable test methods in testing tube specimens, as shown in Fig. 2. D 5947.

TABLE 2 Modulus, 10⁶ psi, for Eight Laboratories, Five Materials

	Mean	S _r	S _R	l _r	l _R
Polypropylene	0.210	0.0089	0.071	0.025	0.201
Cellulose acetate butyrate	0.246	0.0179	0.035	0.051	0.144
Acrylic	0.481	0.0179	0.063	0.051	0.144
Glass-reinforced nylon	1.17	0.0537	0.217	0.152	0.614
Glass-reinforced polyester	1.39	0.0894	0.266	0.253	0.753

10.1.1 Measure the width and thickness of flat specimens at the center of each specimen and within 5 mm of each end of the gage length.

10.1.2 Injection molded specimen dimensions may be determined by actual measurement of only one specimen from each sample when it has previously been demonstrated that the specimen-to-specimen variation in width and thickness is less than 1 %.

10.1.3 Take the width of specimens produced by a Type IV die as the distance between the cutting edges of the die in the narrow section.

10.1.4 Measure the diameter of rod specimens, and the inside and outside diameters of tube specimens, to the nearest 0.025 mm [0.001 in.] at a minimum of two points 90° apart; make these measurements along the groove for specimens so constructed. Use plugs in testing tube specimens, as shown in Fig. 2.

10.2 Place the specimen in the grips of the testing machine, taking care to align the long axis of the specimen and the grips with an imaginary line joining the points of attachment of the grips to the machine. The distance between the ends of the gripping surfaces, when using flat specimens, shall be as indicated in Fig. 1. On tube and rod specimens, the location for the grips shall be as shown in Fig. 2 and Fig. 3. Tighten the grips evenly and firmly to the degree necessary to prevent slippage of the specimen during the test, but not to the point where the specimen would be crushed.

10.3 Attach the extension indicator. When modulus is being determined, a Class B-2 or better extensometer is required (see 5.2.1).

NOTE 13—Modulus of materials is determined from the slope of the linear portion of the stress-strain curve. For most plastics, this linear portion is very small, occurs very rapidly, and must be recorded automatically. The change in jaw separation is never to be used for calculating modulus or elongation.

10.3.1 *Poisson's Ratio Determination:*

10.3.1.1 ~~W~~The measurement of Poisson's Ratio is determined, the speed of testing optional and need be determined only when requested. If the load range tensile modulus is determined at which a test speed of 5 mm/min, it is acceptable to determine the Poisson's ratio at the same time as the tensile modulus.

10.3.1.2 Poisson's Ratio shall be determined at a speed of 5 mm/min. For materials having a distinct linear elastic region on the stress-strain curve the ratio shall be determined in the same load range as those that used for the measurement of the modulus of elasticity. If the material does not exhibit a linear stress to strain relationship the ratio shall be determined within the axial strain range of 0.0005 to 0.0025 mm/mm (0.05 to 0.25%). If the ratio is determined in this manner it shall be noted in the report that a region of proportionality of stress to strain was not evident.

NOTE 14—A suitable method to judge the determination of linearity of the stress to strain curve is by making a series of tangent modulus measurements at different axial strain levels. Values equivalent at each strain level indicate linearity. Values showing a downward trend with increasing strain level indicate non linearity.

10.3.1.23 Attach the transverse strain measuring device. The transverse strain measuring device must continuously measure the strain simultaneously with the axial strain measuring device.

TABLE 3 Tensile Stress at Yield, 10³ psi, for Eight Laboratories, Three Materials

	Mean	S _r	S _R	l _r	l _R
Polypropylene	3.63	0.022	0.161	0.062	0.456
Cellulose acetate butyrate	5.01	0.058	0.227	0.164	0.642
Acrylic	10.4	0.067	0.317	0.190	0.897

10.3.1.34 Make simultaneous measurements of load and strain and record the data. The precision of the value of Poisson's Ratio will depend on the number of data points of axial and transverse strain taken. It is recommended that the data collection rate for the test be a minimum of 20 points per second. This is particularly important for materials having a non linear stress to strain curve.

TABLE 4 Elongation at Yield, %, for Eight Laboratories, Three Materials

	Mean	S_r	S_R	l_r	l_R
Cellulose acetate butyrate	3.65	0.27	0.62	0.76	1.75
Acrylic	4.89	0.21	0.55	0.59	1.56
Polypropylene	8.79	0.45	5.86	1.27	16.5

10.4 Set the speed of testing at the proper rate as required in Section 8, and start the machine.

10.5 Record the load-extension curve of the specimen.

10.6 Record the load and extension at the yield point (if one exists) and the load and extension at the moment of rupture.

NOTE 145—If it is desired to measure both modulus and failure properties (yield or break, or both), it may be necessary, in the case of highly extensible materials, to run two independent tests. The high magnification extensometer normally used to determine properties up to the yield point may not be suitable for tests involving high extensibility. If allowed to remain attached to the specimen, the extensometer could be permanently damaged. A broad-range incremental extensometer or hand-rule technique may be needed when such materials are taken to rupture.

11. Calculation

11.1 Toe compensation shall be made in accordance with Annex A1, unless it can be shown that the toe region of the curve is not due to the take-up of slack, seating of the specimen, or other artifact, but rather is an authentic material response.

11.2 *Tensile Strength*—Calculate the tensile strength by dividing the maximum load in newtons (or [pounds-force]) by the average original minimum cross-sectional area in the gage length segment of the specimen in square metres (or [square inches]). Express the result in pascals (or [pounds-force per square inch]) and report it to three significant figures as tensile strength at yield or tensile strength at break, whichever term is applicable. When a nominal yield or break load less than the maximum is present and applicable, it may be desirable also to calculate, in a similar manner, the corresponding tensile stress at yield or tensile stress at break and report it to three significant figures (see Note A2.8).

11.3 Elongation values are valid and are reported in cases where uniformity of deformation within the specimen gage length is present. Elongation values are quantitatively relevant and appropriate for engineering design. When non-uniform deformation (such as necking) occurs within the specimen gage length nominal strain values are reported. Nominal strain values are of qualitative utility only.

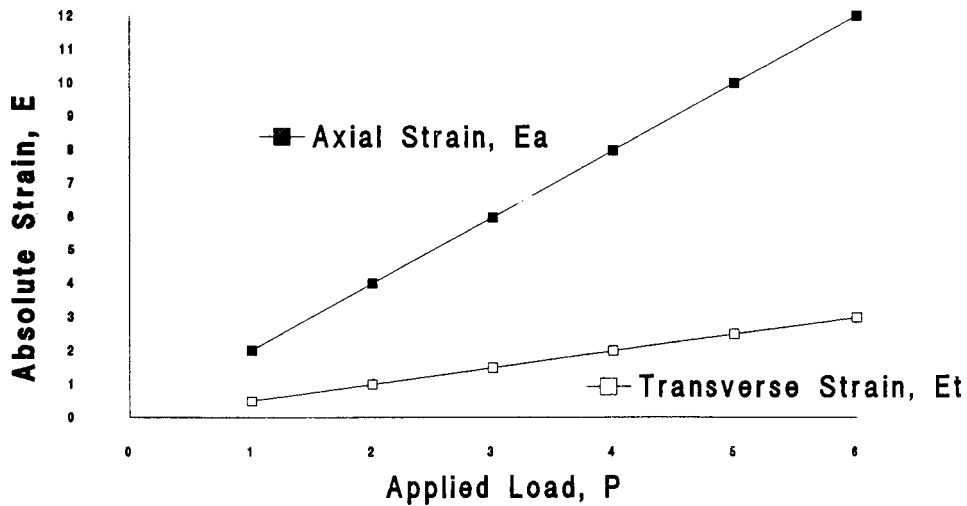

FIG. 4 Plot of Strains Versus Load for Determination of Poisson's Ratio

11.3.1 *Percent Elongation*—Percent elongation is the change in gage length relative to the original specimen gage length, expressed as a percent. Percent elongation is calculated using the apparatus described in 5.2.

11.3.1.1 *Percent Elongation at Yield*—Calculate the percent elongation at yield by reading the extension (change in gage length) at the yield point. Divide that extension by the original gage length and multiply by 100.

11.3.1.2 *Percent Elongation at Break*—Calculate the percent elongation at break by reading the extension (change in gage length) at the point of specimen rupture. Divide that extension by the original gage length and multiply by 100.

11.3.2 *Nominal Strain*—Nominal strain is the change in grip separation relative to the original grip separation expressed as a percent. Nominal strain is calculated using the apparatus described in 5.1.7.

11.3.2.1 *Nominal strain at break*—Calculate the nominal strain at break by reading the extension (change in grip separation) at the point of rupture. Divide that extension by the original grip separation and multiply by 100.

11.4 *Modulus of Elasticity*—Calculate the modulus of elasticity by extending the initial linear portion of the load-extension curve and dividing the difference in stress corresponding to any segment of section on this straight line by the corresponding difference in strain. All elastic modulus values shall be computed using the average ~~initial~~ original cross-sectional area in the gage length segment of the ~~test specimens~~ specimen in the calculations. The result shall be expressed in pascals-([pounds-force per square inch]) and reported to three significant figures.

11.5 *Secant Modulus*—At a designated strain, this shall be calculated by dividing the corresponding stress (nominal) by the designated strain. Elastic modulus values are preferable and shall be calculated whenever possible. However, for materials where no proportionality is evident, the secant value shall be calculated. Draw the tangent as directed in A1.3 and Fig. A1.2, and mark off the designated strain from the yield point where the tangent line goes through zero stress. The stress to be used in the calculation is then determined by dividing the load-extension curve by the original average cross-sectional area of the specimen.

11.6 *Poisson’s Ratio*—The axial strain, ϵ_a , indicated by the axial extensometer, and the transverse strain, ϵ_t , indicated by the transverse extensometers, are plotted against the applied load, P , as shown in Fig. 4. ~~A 4.~~

11.6.1 For those materials where there is proportionality of stress to strain and it is possible to determine a modulus of elasticity, a straight line is drawn through each set of points within the load range used for determination of modulus, and the slopes; $d\epsilon_a / dP$ and $d\epsilon_t / dP$, of these lines are determined. The use of a least squares method of calculation will reduce errors resulting from drawing lines. Poisson’s ratio, μ , is then calculated as follows:

$$\mu = -(d\epsilon_t / dP) / (d\epsilon_a / dP) \tag{1}$$

where:

$d\epsilon_t$ = change in transverse strain,

$d\epsilon_a$ = change in axial strain, and

dP = change in applied load;

or

$$\mu = -(d\epsilon_t) / (d\epsilon_a) \tag{2}$$

11.6.1 The

The errors that may be introduced by drawing a straight line through the points can be reduced by applying the ~~method of least squares method.~~

11.6.2 For those materials where there is no proportionality of stress to strain evident determine the ratio of $d\epsilon_t / d\epsilon_a$ when $d\epsilon_a = 0.002$ (based on axial strain range of 0.0005 to 0.0025 mm/mm) and after toe compensation has been made.

$$\mu = d\epsilon_t / 0.002 \tag{3}$$

11.7 For each series of tests, calculate the arithmetic mean of all values obtained and report it as the “average value” for the particular property in question.

11.8 Calculate the standard deviation (estimated) as follows and report it to two significant figures:

$$s = \sqrt{(\Sigma X^2 - n\bar{X}^2) / (n - 1)} \tag{4}$$

where:

s = estimated standard deviation,

X = value of single observation,

n = number of observations, and

\bar{X} = arithmetic mean of the set of observations.

11.9 See Annex A1 for information on toe compensation.

TABLE 5 Tensile Strength at Break, 10³ psi, for Eight Laboratories, Five Materials^A

	Mean	S_r	S_R	I_r	I_R
Polypropylene	2.97	1.54	1.65	4.37	4.66
Cellulose acetate butyrate	4.82	0.058	0.180	0.164	0.509
Acrylic	9.09	0.452	0.751	1.27	2.13
Glass-reinforced polyester	20.8	0.233	0.437	0.659	1.24
Glass-reinforced nylon	23.6	0.277	0.698	0.784	1.98

^A Tensile strength and elongation at break values obtained for unreinforced propylene plastics generally are highly variable due to inconsistencies in necking or “drawing” of the center section of the test bar. Since tensile strength and elongation at yield are more reproducible and relate in most cases to the practical usefulness of a molded part, they are generally recommended for specification purposes.

TABLE 6 Elongation at Break, %, for Eight Laboratories, Five Materials^A

	Mean	S_r	S_R	l_r	l_R
Glass-reinforced polyester	3.68	0.20	2.33	0.570	6.59
Glass-reinforced nylon	3.87	0.10	2.13	0.283	6.03
Acrylic	13.2	2.05	3.65	5.80	10.3
Cellulose acetate butyrate	14.1	1.87	6.62	5.29	18.7
Polypropylene	293.0	50.9	119.0	144.0	337.0

^A Tensile strength and elongation at break values obtained for unreinforced propylene plastics generally are highly variable due to inconsistencies in necking or "drawing" of the center section of the test bar. Since tensile strength and elongation at yield are more reproducible and relate in most cases to the practical usefulness of a molded part, they are generally recommended for specification purposes.

TABLE 7 Tensile Yield Strength, for Ten Laboratories, Eight Materials

Material	Test Speed, in./min	Values Expressed in psi Units				
		Average	S_r	S_R	r	R
LDPE	20	1544	52.4	64.0	146.6	179.3
LDPE	20	1894	53.1	61.2	148.7	171.3
LLDPE	20	1879	74.2	99.9	207.8	279.7
LLDPE	20	1791	49.2	75.8	137.9	212.3
LLDPE	20	2900	55.5	87.9	155.4	246.1
LLDPE	20	1730	63.9	96.0	178.9	268.7
HDPE	2	4101	196.1	371.9	549.1	1041.3
HDPE	2	3523	175.9	478.0	492.4	1338.5

12. Report

12.1 Report the following information:

12.1.1 Complete identification of the material tested, including type, source, manufacturer's code numbers, form, principal dimensions, previous history, etc.,

12.1.2 Method of preparing test specimens,

12.1.3 Type of test specimen and dimensions,

12.1.4 Conditioning procedure used,

12.1.5 Atmospheric conditions in test room,

12.1.6 Number of specimens tested,

12.1.7 Speed of testing,

12.1.8 Classification of extensometers used. A description of measuring technique and calculations employed instead of a minimum Class-C extensometer system,

12.1.9 Tensile strength at yield or break, average value, and standard deviation,

12.1.10 Tensile stress at yield or break, if applicable, average value, and standard deviation,

12.1.11 Percent elongation at yield, or break, or nominal strain at break, or all three, as applicable, average value, and standard deviation,

12.1.12 Modulus of elasticity or secant modulus, average value, and standard deviation,

12.1.13 ~~If measured~~, Poisson's ratio, average value, standard deviation, and statement of whether there was proportionality within the strain range,

12.1.14 Date of test, and

12.1.14⁵ Revision date of Test Method D 638.

13. Precision and Bias ⁴

13.1 *Precision*—Tables 2-6 are based on a round-robin test conducted in 1984, involving five materials tested by eight laboratories using the Type I specimen, all of nominal 0.125-in. thickness. Each test result was based on five individual determinations. Each laboratory obtained two test results for each material.

13.1.1 Tables 7-10 are based on a round-robin test conducted by the polyolefin subcommittee in 1988, involving eight polyethylene materials tested in ten laboratories. For each material, all samples were molded at one source, but the individual

TABLE 8 Tensile Yield Elongation, for Eight Laboratories, Eight Materials

Material	Test Speed, in./min	Values Expressed in Percent Units				
		Average	S_r	S_R	r	R
LDPE	20	17.0	1.26	3.16	3.52	8.84
LDPE	20	14.6	1.02	2.38	2.86	6.67
LLDPE	20	15.7	1.37	2.85	3.85	7.97
LLDPE	20	16.6	1.59	3.30	4.46	9.24
LLDPE	20	11.7	1.27	2.88	3.56	8.08
LLDPE	20	15.2	1.27	2.59	3.55	7.25
HDPE	2	9.27	1.40	2.84	3.91	7.94
HDPE	2	9.63	1.23	2.75	3.45	7.71

TABLE 9 Tensile Break Strength, for Nine Laboratories, Six Materials

Material	Test Speed, in./min	Values Expressed in psi Units				
		Average	S_r	S_R	r	R
LDPE	20	1592	52.3	74.9	146.4	209.7
LDPE	20	1750	66.6	102.9	186.4	288.1
LLDPE	20	4379	127.1	219.0	355.8	613.3
LLDPE	20	2840	78.6	143.5	220.2	401.8
LLDPE	20	1679	34.3	47.0	95.96	131.6
LLDPE	20	2660	119.1	166.3	333.6	465.6

TABLE 10 Tensile Break Elongation, for Nine Laboratories, Six Materials

Material	Test Speed, in./min	Values Expressed in Percent Units				
		Average	S_r	S_R	r	R
LDPE	20	567	31.5	59.5	88.2	166.6
LDPE	20	569	61.5	89.2	172.3	249.7
LLDPE	20	890	25.7	113.8	71.9	318.7
LLDPE	20	64.4	6.68	11.7	18.7	32.6
LLDPE	20	803	25.7	104.4	71.9	292.5
LLDPE	20	782	41.6	96.7	116.6	270.8

specimens were prepared at the laboratories that tested them. Each test result was the average of five individual determinations. Each laboratory obtained three test results for each material. Data from some laboratories could not be used for various reasons, and this is noted in each table.

13.1.2 Table 11 is based on a repeatability study involving a single laboratory. The two materials used were unfilled

TABLE 11 Poisson's Ratio Repeatability Data for One Laboratory and Two Polypropylene Materials

Materials	Values Expressed as a Dimensionless Ratio		
	Average	S_r	r
PP #1 Chord	0.412	0.009	0.026
PP #1 Least Squares	0.413	0.011	0.032
PP #2 Chord	0.391	0.009	0.026
PP #2 Least Squares	0.392	0.010	0.028

polypropylene types. Measurements were performed by a single technician on a single day. Each test result is an individual determination. Testing was run using two Type B-1 extensometers for transverse and axial measurements at a test speed of 5 mm/min.

13.1.3 In Tables 2-10₁, for the materials indicated, and for test results that derived from testing five specimens:

13.1.23.1 S_r is the within-laboratory standard deviation of the average; $I_r = 2.83 S_r$. (See 13.1.23.3 for application of I_r .)

13.1.23.2 S_R is the between-laboratory standard deviation of the average; $I_R = 2.83 S_R$. (See 13.1.23.4 for application of I_R .)

13.1.23.3 *Repeatability*—In comparing two test results for the same material, obtained by the same operator using the same equipment on the same day, those test results should be judged not equivalent if they differ by more than the I_r value for that material and condition.

13.1.23.4 *Reproducibility*—In comparing two test results for the same material, obtained by different operators using different equipment on different days, those test results should be judged not equivalent if they differ by more than the I_R value for that material and condition. (This applies between different laboratories or between different equipment within the same laboratory.)

13.1.23.5 Any judgment in accordance with 13.1.23.3 and 13.1.23.4 will have an approximate 95 % (0.95) probability of being correct.

13.1.23.6 Other formulations may give somewhat different results.

13.1.23.7 For further information on the methodology used in this section, see Practice E 691.

13.1.23.8 The precision of this test method is very dependent upon the uniformity of specimen preparation, standard practices for which are covered in other documents.

13.2 *Bias*—There are no recognized standards on which to base an estimate of bias for this test method.

14. Keywords

14.1 modulus of elasticity; percent elongation; plastics; Poisson's ratio; tensile properties; tensile strength

ANNEXES

(Mandatory Information)

A1. TOE COMPENSATION

A1.1 In a typical stress-strain curve (Fig. A1.1) there is a toe region, *AC*, that does not represent a property of the material. It is an artifact caused by a take-up of slack and alignment or seating of the specimen. In order to obtain correct values of such parameters as modulus, strain, and offset yield point, this artifact must be compensated for to give the corrected zero point on the strain or extension axis.

A1.2 In the case of a material exhibiting a region of Hookean (linear) behavior (Fig. A1.1), a continuation of the linear (*CD*) region of the curve is constructed through the zero-stress axis. This intersection (*B*) is the corrected zero-strain point from which all extensions or strains must be measured, including the yield offset (*BE*), if applicable. The elastic modulus can be determined by dividing the stress at any point along the line *CD* (or its extension) by the strain at the same point (measured from Point *B*, defined as zero-strain).

A1.3 In the case of a material that does not exhibit any linear region (Fig. A1.2), the same kind of toe correction of the zero-strain point can be made by constructing a tangent to the maximum slope at the inflection point (*H'*). This is extended to intersect the strain axis at Point *B'*, the corrected zero-strain point. Using Point *B'* as zero strain, the stress at any point (*G'*) on

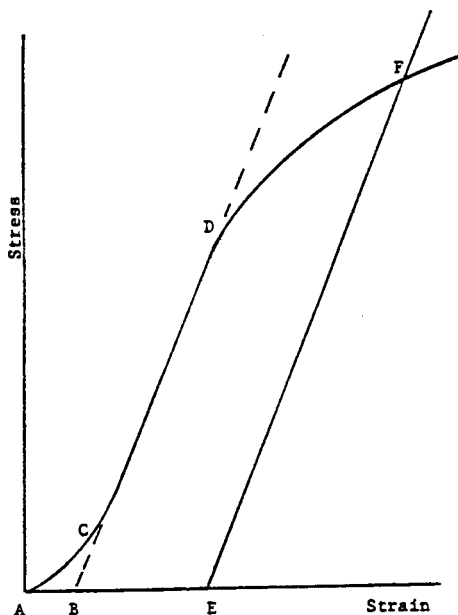

NOTE 1—Some chart recorders plot the mirror image of this graph.

FIG. A1.1 Material with Hookean Region

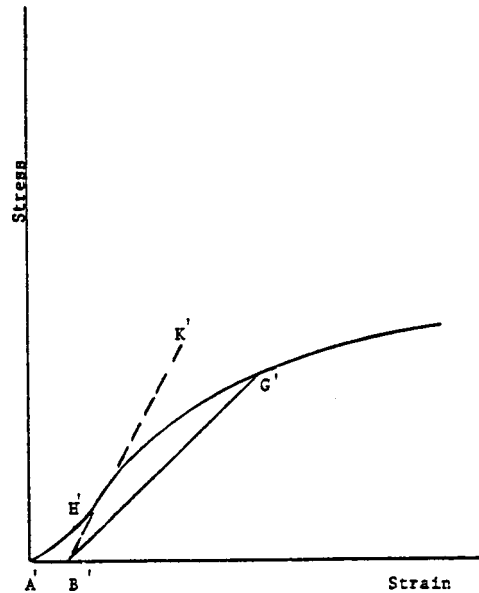

NOTE 1—Some chart recorders plot the mirror image of this graph.

FIG. A1.2 Material with No Hookean Region

the curve can be divided by the strain at that point to obtain a secant modulus (slope of Line $B' G'$). For those materials with no linear region, any attempt to use the tangent through the inflection point as a basis for determination of an offset yield point may result in unacceptable error.

A2. DEFINITIONS OF TERMS AND SYMBOLS RELATING TO TENSION TESTING OF PLASTICS

A2.1 *elastic limit*—the greatest stress which a material is capable of sustaining without any permanent strain remaining upon complete release of the stress. It is expressed in force per unit area, usually megapascals [pounds-force per square inch (megapascals); inch].

NOTE A2.1—Measured values of proportional limit and elastic limit vary greatly with the sensitivity and accuracy of the testing equipment, eccentricity of loading, the scale to which the stress-strain diagram is plotted, and other factors. Consequently, these values are usually replaced by yield strength.

A2.2 *elongation*—the increase in length produced in the gage length of the test specimen by a tensile load. It is expressed in units of length, usually inches (millimetres); millimetres [inches]. (Also known as *extension*.)

NOTE A2.2—Elongation and strain values are valid only in cases where uniformity of specimen behavior within the gage length is present. In the case of materials exhibiting necking phenomena, such values are only of qualitative utility after attainment of yield point. This is due to inability to ensure that necking will encompass the entire length between the gage marks prior to specimen failure.

A2.3 *gage length*—the original length of that portion of the specimen over which strain or change in length is determined.

A2.4 *modulus of elasticity*—the ratio of stress (nominal) to corresponding strain below the proportional limit of a material. It is expressed in force per unit area, usually megapascals ([pounds-force per square inch]). (Also known as *elastic modulus* or *Young's modulus*).

NOTE A2.3—The stress-strain relations of many plastics do not conform to Hooke's law throughout the elastic range but deviate therefrom even at stresses well below the elastic limit. For such materials the slope of the tangent to the stress-strain curve at a low stress is usually taken as the modulus of elasticity. Since the existence of a true proportional limit in plastics is debatable, the propriety of applying the term "modulus of elasticity" to describe the stiffness or rigidity of a plastic has been seriously questioned. The exact stress-strain characteristics of plastic materials are very dependent on such factors as rate of stressing, temperature, previous specimen history, etc. However, such a value is useful if its arbitrary nature and dependence on time, temperature, and other factors are realized.

A2.5 *necking*—the localized reduction in cross section which may occur in a material under tensile stress.

A2.6 *offset yield strength*—the stress at which the strain exceeds by a specified amount (the offset) an extension of the initial proportional portion of the stress-strain curve. It is expressed in force per unit area, usually megapascals ([pounds-force per square inch]).

NOTE A2.4—This measurement is useful for materials whose stress-strain curve in the yield range is of gradual curvature. The offset yield strength

can be derived from a stress-strain curve as follows (Fig. A2.1):

On the strain axis lay off OM equal to the specified offset.

Draw OA tangent to the initial straight-line portion of the stress-strain curve.

Through M draw a line MN parallel to OA and locate the intersection of MN with the stress-strain curve.

The stress at the point of intersection r is the “offset yield strength.” The specified value of the offset must be stated as a percent of the original gage length in conjunction with the strength value. Example: 0.1 % offset yield strength = ... MPa-(psi), [psi], or yield strength at 0.1 % offset ... MPa-(psi), [psi].

A2.7 *percent elongation*—the elongation of a test specimen expressed as a percent of the gage length.

A2.8 *percent elongation at break and yield*:

A2.8.1 *percent elongation at break* —the percent elongation at the moment of rupture of the test specimen.

A2.8.2 *percent elongation at yield* —the percent elongation at the moment the yield point (A2.242) is attained in the test specimen.

A2.9 *percent reduction of area (nominal)*—the difference between the original cross-sectional area measured at the point of rupture after breaking and after all retraction has ceased, expressed as a percent of the original area.

A2.10 *percent reduction of area (true)*—the difference between the original cross-sectional area of the test specimen and the minimum cross-sectional area within the gage boundaries prevailing at the moment of rupture, expressed as a percentage of the original area.

A2.11 *proportional limit*Poisson’s Ratio—the greatest stress which a material is capable of sustaining without any deviation from proportionality the ratio of its transverse strain to the corresponding axial strain (Hooke’s law). It is expressed in force per unit area, usually megapascals (pounds-force per square inch), resulting from uniformly distributed axial stress below the proportional limit of the material.

A2.12 *rate of loading*proportional limit—the change in tensile load carried by the specimen per unit time, greatest stress which a material is capable of sustaining without any deviation from proportionality of stress to strain (Hooke’s law). It is expressed in force per unit time, area, usually newtons (pounds-force) megapascals [pounds-force per minute]. The initial rate of loading can be calculated from the initial slope of the load versus time diagram, square inch].

A2.13 *rate of loading*—the change in tensile load carried by the specimen per unit time. It is expressed in force per unit time, usually newtons [pounds-force] per minute. The initial rate of loading can be calculated from the initial slope of the load versus time diagram.

A2.14 *rate of straining*—the change in tensile strain per unit time. It is expressed either as strain per unit time, usually metres per metre-[inches per inch] per minute, or percent elongation per unit time, usually percent elongation per minute. The initial rate of straining can be calculated from the initial slope of the tensile strain versus time diagram.

NOTE A2.5—The initial rate of straining is synonymous with the rate of crosshead movement divided by the initial distance between crossheads only in a machine with constant rate of crosshead movement and when the specimen has a uniform original cross section, does not “neck down,” and does not slip in the jaws.

A2.145 *rate of stressing (nominal)*—the change in tensile stress (nominal) per unit time. It is expressed in force per unit area per unit time, usually megapascals-[pounds-force per square inch] per minute. The initial rate of stressing can be calculated from

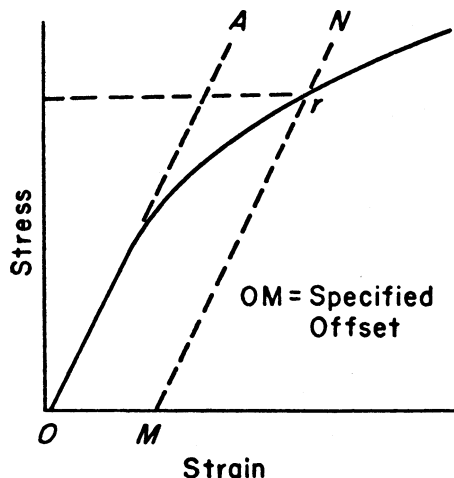

FIG. A2.1 Offset Yield Strength

the initial slope of the tensile stress (nominal) versus time diagram.

NOTE A2.6—The initial rate of stressing as determined in this manner has only limited physical significance. It does, however, roughly describe the average rate at which the initial stress (nominal) carried by the test specimen is applied. It is affected by the elasticity and flow characteristics of the materials being tested. At the yield point, the rate of stressing (true) may continue to have a positive value if the cross-sectional area is decreasing.

A2.156 *secant modulus*—the ratio of stress (nominal) to corresponding strain at any specified point on the stress-strain curve. It is expressed in force per unit area, usually megapascals-([pounds-force per square inch]), and reported together with the specified stress or strain.

NOTE A2.7—This measurement is usually employed in place of modulus of elasticity in the case of materials whose stress-strain diagram does not demonstrate proportionality of stress to strain.

A2.167 *strain*—the ratio of the elongation to the gage length of the test specimen, that is, the change in length per unit of original length. It is expressed as a dimensionless ratio.

A2.167.1 *nominal strain at break*—the strain at the moment of rupture relative to the original grip separation.

A2.17 *tensile strength (nominal)*—the maximum tensile stress (nominal) sustained by the specimen during a tension test. When the maximum stress occurs at the yield point (A2.21), it shall be designated tensile strength at yield. When the maximum stress occurs at break, it shall be designated tensile strength at break.

A2.18 *tensile strength (nominal)*—the maximum tensile stress (nominal) sustained by the specimen during a tension test. When the maximum stress occurs at the yield point (A2.22), it shall be designated tensile strength at yield. When the maximum stress occurs at break, it shall be designated tensile strength at break.

A2.19 *tensile stress (nominal)*—the tensile load per unit area of minimum original cross section, within the gage boundaries, carried by the test specimen at any given moment. It is expressed in force per unit area, usually megapascals-([pounds-force per square inch]).

NOTE A2.8—The expression of tensile properties in terms of the minimum original cross section is almost universally used in practice. In the case of materials exhibiting high extensibility or necking, or both (A2.156), nominal stress calculations may not be meaningful beyond the yield point (A2.242) due to the extensive reduction in cross-sectional area that ensues. Under some circumstances it may be desirable to express the tensile properties per unit of minimum prevailing cross section. These properties are called true tensile properties (that is, true tensile stress, etc.).

~~A2.19~~

A2.20 *tensile stress-strain curve*—a diagram in which values of tensile stress are plotted as ordinates against corresponding values of tensile strain as abscissas.

A2.201 *true strain* (see Fig. A2.2) is defined by the following equation for ϵ_T :

$$\epsilon_T = \int_{L_o}^L dL/L = \ln L/L_o \tag{A2.1}$$

where:

- dL = increment of elongation when the distance between the gage marks is L ,
- L_o = original distance between gage marks, and
- L = distance between gage marks at any time.

A2.242 *yield point*—the first point on the stress-strain curve at which an increase in strain occurs without an increase in stress (Fig. A2.2).

NOTE A2.9—Only materials whose stress-strain curves exhibit a point of zero slope may be considered as having a yield point.

NOTE A2.10—Some materials exhibit a distinct “break” or discontinuity in the stress-strain curve in the elastic region. This break is not a yield point by definition. However, this point may prove useful for material characterization in some cases.

A2.223 *yield strength*—the stress at which a material exhibits a specified limiting deviation from the proportionality of stress to strain. Unless otherwise specified, this stress will be the stress at the yield point and when expressed in relation to the tensile strength shall be designated either tensile strength at yield or tensile stress at yield as required in A2.178 (Fig. A2.3). (See *offset yield strength*.)

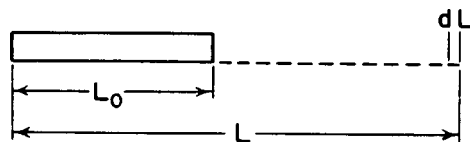

FIG. A2.2 Illustration of True Strain Equation

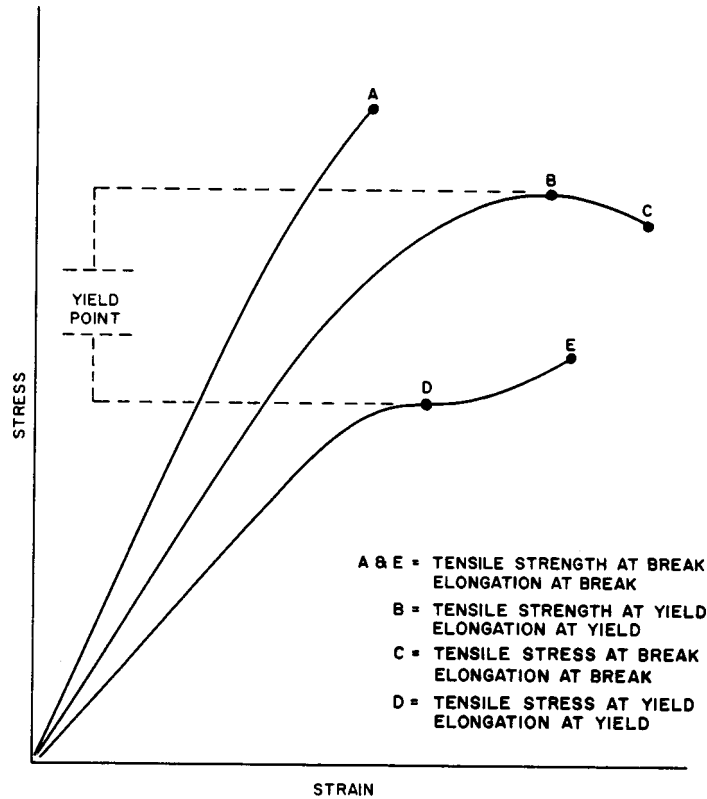

FIG. A2.3 Tensile Designations

A2.234 Symbols—The following symbols may be used for the above terms:

Symbol	Term
W	Load
ΔW	Increment of load
L	Distance between gage marks at any time
L_o	Original distance between gage marks
L_u	Distance between gage marks at moment of rupture
ΔL	Increment of distance between gage marks = elongation
A	Minimum cross-sectional area at any time
A_o	Original cross-sectional area
ΔA	Increment of cross-sectional area
A_u	Cross-sectional area at point of rupture measured after breaking specimen
A_T	Cross-sectional area at point of rupture, measured at the moment of rupture
t	Time
Δt	Increment of time
σ	Tensile stress
$\Delta \sigma$	Increment of stress
σ_T	True tensile stress
σ_U	Tensile strength at break (nominal)
σ_{UT}	Tensile strength at break (true)
ϵ	Strain
$\Delta \epsilon$	Increment of strain
ϵ_U	Total strain, at break
ϵ_T	True strain
%EI	Percentage elongation
Y.P.	Yield point
E	Modulus of elasticity

A2.245 Relations between these various terms may be defined as follows:

σ	=	W/A_o
σ_T	=	W/A
σ_U	=	W/A_o (where W is breaking load)
σ_{UT}	=	W/A_T (where W is breaking load)
ϵ	=	$\Delta L/L_o = (L - L_o)/L_o$
ϵ_U	=	$(L_u - L_o)/L_o$
ϵ_T	=	$\int_{L_o}^L dL/L = \ln L/L_o$
%EI	=	$[(L - L_o)/L_o] \times 100 = \epsilon \times 100$

Percent reduction of area (nominal) = $[(A_o - A_u)/A_o] \times 100$

Percent reduction of area (true) = $[(A_o - A_T)/A_o] \times 100$

Rate of loading = $\Delta W/\Delta t$

Rate of stressing (nominal) = $\Delta\sigma/\Delta t = (\Delta W)/A_o/\Delta t$

Rate of straining = $\Delta\epsilon/\Delta t = (\Delta L/L_o)/\Delta t$

For the case where the volume of the test specimen does not change during the test, the following three relations hold:

$$\sigma_T = \sigma(1 + \epsilon) = \sigma L/L_o \quad (A2.2)$$

$$\sigma_{UT} = \sigma_U(1 + \epsilon_U) = \sigma_U L_u/L_o$$

$$A = A_o/(1 + \epsilon)$$

SUMMARY OF CHANGES

This section identifies the location of selected changes to this test method. For the convenience of the user, Committee D20 has highlighted those changes that may impact the use of this test method. This section may also include descriptions of the changes or reasons for the changes, or both.

~~D 638-02a~~: D 638 - 03:

(1) Revised paragraphs 5.3, 10.1, 11.2, and 11.4 to reflect use of D 5947 and harmonization with ISO 527.

(2) Revised 8.4.

(3) Added new 10.3.1.1.

(4) Renumbered old 10.3.1.1 to 10.3.1.2.

(5) Added new Note 14.

(6) Renumbered old 10.3.1.2 to 10.3.1.3.

(7) Renumbered old 10.3.1.3 to 10.3.1.4.

(8) Revised wording of new 10.3.1.4.

(9) Renumbered old Note 14 to 15.

(10) Revised 11.6.

(11) Revised 11.6.1.

(12) Added new 11.6.2.

(13) Added new equation (3).

(14) Renumbered old equation (3) to (4).

(15) Revised 12.1.12.

(16) Added new 12.1.13.

(17) Add new Table 11.

(18) Add new 13.1.2.

(19) Renumbered old 13.1.2 through 13.1.2.8 to 13.1.3 through 13.1.3.8.

(20) Added Poisson's ratio to 14.1 Keywords.

(21) Added new A2.11.

(22) Renumbered A2.11 through A2.24 to A2.12 through A2.25.

D 638 - 02a:

(1) Added 5.1.7.

(2) Added new text from 11.3 to 11.3.2.1.

(3) Revised 12.1.11.

(4) Added A2.16.1.

D 638= - 02:

(1) Revised 9.1 and 9.2.

D 638= - 01:

(1) Modified 7.3 regarding conditions for specimen discard.

D 638= - 00:

(1) Added 11.1 and renumbered subsequent sections.

D 638= - 99:

(1) Added and clarified extensometer classification requirements.

D 638= - 98:

(1) Revised 10.3 and added 12.1.8 to clarify extensometer usage.

(2) Added 12.1.145.

(3) Replaced reference to Test Methods D 374 with Test Method D 5947 in 2.1 and 5.3.

ASTM International takes no position respecting the validity of any patent rights asserted in connection with any item mentioned in this standard. Users of this standard are expressly advised that determination of the validity of any such patent rights, and the risk of infringement of such rights, are entirely their own responsibility.

This standard is subject to revision at any time by the responsible technical committee and must be reviewed every five years and if not revised, either reapproved or withdrawn. Your comments are invited either for revision of this standard or for additional standards and should be addressed to ASTM International Headquarters. Your comments will receive careful consideration at a meeting of the responsible technical committee, which you may attend. If you feel that your comments have not received a fair hearing you should make your views known to the ASTM Committee on Standards, at the address shown below.

This standard is copyrighted by ASTM International, 100 Barr Harbor Drive, PO Box C700, West Conshohocken, PA 19428-2959, United States. Individual reprints (single or multiple copies) of this standard may be obtained by contacting ASTM at the above address or at 610-832-9585 (phone), 610-832-9555 (fax), or service@astm.org (e-mail); or through the ASTM website (www.astm.org).