



Designation: D 3612 – 01

Standard Test Method for Analysis of Gases Dissolved in Electrical Insulating Oil by Gas Chromatography¹

This standard is issued under the fixed designation D 3612; the number immediately following the designation indicates the year of original adoption or, in the case of revision, the year of last revision. A number in parentheses indicates the year of last reappraisal. A superscript epsilon (ϵ) indicates an editorial change since the last revision or reappraisal.

1. Scope

1.1 This test method covers three procedures for extraction and measurement of gases dissolved in electrical insulating oil having a viscosity of 20 cSt (100 SUS) or less at 40°C (104°F), and the identification and determination of the individual component gases extracted. Other methods have been used to perform this analysis.

1.2 The individual component gases that may be identified and determined include:

Hydrogen—H₂
Oxygen—O₂
Nitrogen—N₂
Carbon monoxide—CO
Carbon dioxide—CO₂
Methane—CH₄
Ethane—C₂H₆
Ethylene—C₂H₄
Acetylene—C₂H₂
Propane—C₃H₈
Propylene—C₃H₆

1.3 This standard does not purport to address all of the safety concerns, if any, associated with its use. It is the responsibility of the user of this standard to establish appropriate safety and health practices and determine the applicability of regulatory limitations prior to use. For specific precautionary statements see 6.1.8.

2. Referenced Documents

2.1 ASTM Standards:

- D 2140 Test Method for Carbon-Type Composition of Insulating Oils of Petroleum Origin²
- D 2300 Test Method for Gassing of Insulating Oils Under Electrical Stress and Ionization Modified Pirelli Method²
- D 2779 Test Method for Estimation of Solubility of Gases in Petroleum Liquids³
- D 2780 Test Method for Solubility of Fixed Gases in Liquids³
- D 3613 Test Methods of Sampling Electrical Insulating Oils for Gas Analysis and Determination of Water Content²

¹ This test method is under the jurisdiction of ASTM Committee D27 on Electrical Insulating Liquids and Gases and is the direct responsibility of Subcommittee D27.03 on Analytical Tests.

Current edition approved Feb. 10, 2001. Published April 2001. Originally published as D 3612 – 77. Last previous edition D 3612 – 96.

² Annual Book of ASTM Standards, Vol 10.03.

³ Annual Book of ASTM Standards, Vol 05.02.

D 4051 Practice for Preparation of Low-Pressure Gas Blends³

E 260 Practice for Packed Column Gas Chromatography⁴

2.2 IEEE Standard:

C 57.104 Guide for the Interpretation of Gases Generated in Oil-Immersed Transformers⁵

2.3 IEC Standard:

Publication No. 567 Guide for the Sampling of Gases and of Oil from Oil-Filled Electrical Equipment and for the Analysis of Free and Dissolved Gases⁶

3. Terminology

3.1 Definitions of Terms Specific to This Standard:

3.1.1 *gas content of oil by volume*—in Method A, the total volume of gases, corrected to 760 torr (101.325 kPa) and 0°C, contained in a given volume of oil, expressed as a percentage. In Methods B and C, the sum of the individual gas concentrations corrected to 760 torr (101.325 kPa) and 0°C, expressed in percent or parts per million.

3.1.2 *headspace*—a volume of gas phase in contact with a volume of oil in a closed vessel. The vessel is a headspace vial of 20-mL nominal capacity.

3.1.2.1 *Discussion*—Other vessel volumes may also be used, but the analytical performance may be somewhat different than that specified in Method C.

3.1.3 *parts per million (ppm) by volume of (specific gas) in oil*—the volume of that gas corrected to 760 torr (101.325 kPa) and 0°C, contained in 10⁶ volume of oil.

3.1.4 *sparging, v*—agitating the liquid sample using a gas to strip other gases free.

3.1.5 *volume concentration of (specific gas) in the gas sample*—the volume of the specific gas contained in a given volume of the gas sample at the same temperature and pressure (as the measured total volume), expressed either as a percentage or in parts per million.

4. Summary of Test Method

4.1 *Method A*—Dissolved gases are extracted from a sample of oil by introduction of the oil sample into a pre-evacuated known volume. The evolved gases are compressed to atmospheric pressure and the total volume measured.

⁴ Annual Book of ASTM Standards, Vol 14.02.

⁵ Available from IEEE, 345 E. 47th St., New York, NY 10017.

⁶ Available from IEC.

4.2 *Method B*—Dissolved gases are extracted from a sample of oil by sparging the oil with the carrier gas on a stripper column containing a high surface area bead.

4.3 *Method C*—Method C consists of bringing an oil sample in contact with a gas phase (headspace) in a closed vessel purged with argon. The dissolved gases contained in the oil are then equilibrated in the two phases in contact under controlled conditions (in accordance with Henry's law). At equilibrium, the headspace is overpressurized with argon and then the content of a loop is filled by the depressurization of the headspace against the ambient atmospheric pressure. The gases contained in the loop are then introduced into a gas chromatograph.

4.4 There may be some differences in the limits of detection and precision and bias between Methods A, B, and C for various gases.

4.5 A portion of the extracted gases (Method A) or all of the extracted gases (Method B) or a portion of the headspace gases (Method C) is introduced into a gas chromatograph. Calibration curves are used in Method C to establish the concentration of each species. The composition of the sample is calculated from its chromatogram by comparing the area of the peak of each component with the area of the peak of the same component on a reference chromatogram made on a standard mixture of known composition.

5. Significance and Use

5.1 Oil and oil-immersed electrical insulation materials may decompose under the influence of thermal and electrical stresses, and in doing so, generate gaseous decomposition products of varying composition which dissolve in the oil. The nature and amount of the individual component gases that may be recovered and analyzed may be indicative of the type and degree of the abnormality responsible for the gas generation. The rate of gas generation and changes in concentration of specific gases over time are also used to evaluate the condition of the electric apparatus.

NOTE 1—Guidelines for the interpretation of gas-in-oil data are given in IEEE C57.104.

6. Apparatus

6.1 Apparatus⁷ of the type shown in Fig. 1 or Fig. 2 is suitable for use with up to 50-mL samples of oil and consists of the following components:

NOTE 2—This sample size has been found to be sufficient for most oils. However, oil that has had only limited exposure to air may contain much

⁷ Ace Glass and Lurex Glass manufacture glass extractors. For Ace Glass, the glass apparatus conforming to Fig. 1 is Part E-13099-99-99 and Fig. 2 is Part E-1400-99. Available from P.O. Box 688, 1430 Northwest Blvd., Vineland, NJ 08360 or Lurex Glass, 1298 Northwest Blvd., Vineland, NJ 08360.

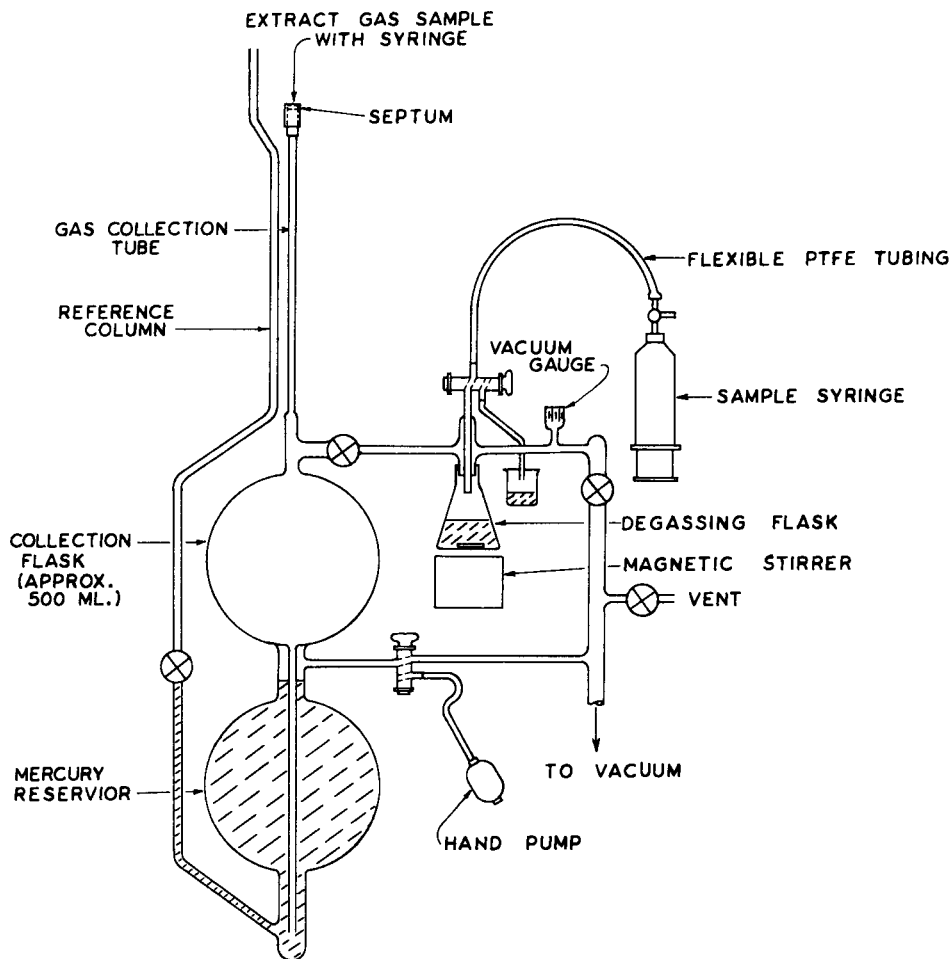

FIG. 1 Extraction of Gas from Insulating Oil

ASTM D 3612

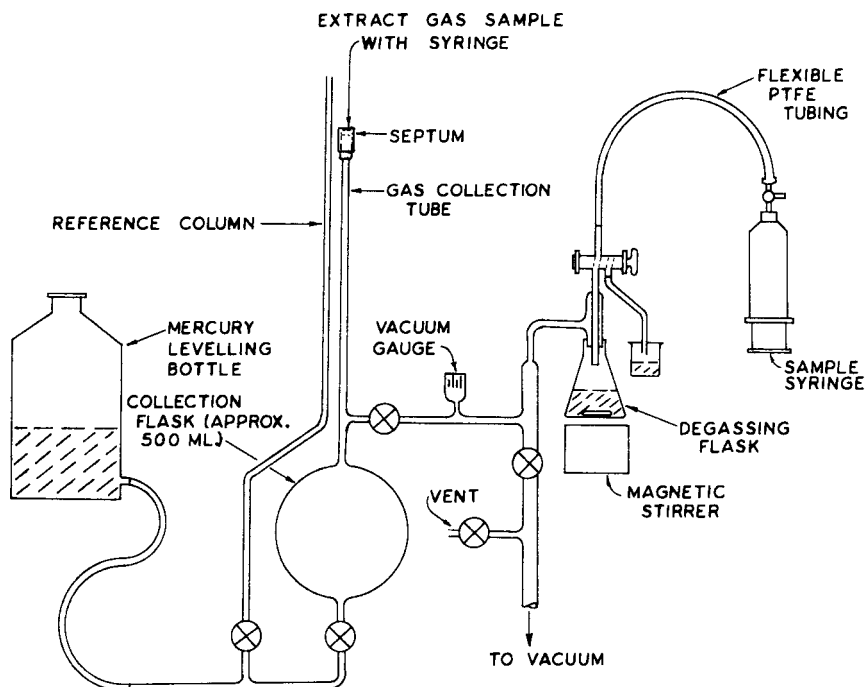

FIG. 2 Extraction of Gas from Insulating Oil

smaller amounts of nitrogen and oxygen. For these oils it may be desirable to increase the size of the sample and the extraction apparatus.

NOTE 3—Alternative apparatus designs including the use of a Toepler pump have also been found successful.

6.1.1 *Polytetrafluoroethylene (PTFE) Tubing*, narrow-bore, terminated with a Luer-Lock fitted glass syringe, and leading to a solid plug, three-way, high-vacuum stopcock.

6.1.2 *Degassing Flask*, with a glass inlet tube, of sufficient volume to contain up to 50 mL of oil below the inlet tube, capable of being evacuated through a vacuum pump, containing a PTFE-coated magnetic spin bar, and mounted on a magnetic stirrer.

6.1.3 *Means of Measuring Absolute Pressure* within the apparatus.

6.1.4 *Vacuum Pumping System*, capable of evacuating the glassware to an absolute pressure of 1×10^{-3} torr (130 mPa) or lower.

6.1.5 *Vacuum Glassware*, sufficiently large compared to the volume of the oil sample, so that virtually complete degassing is obtained and that the volumetric collection ratio is as large as possible. A 500-mL gas collecting flask has been found suitable.

6.1.6 *High-Vacuum Valves or Stopcocks*, employing the minimum necessary amounts of high-vacuum stopcock grease are used throughout the apparatus.

6.1.7 *Gas Collection Tube*, calibrated in 0.01-mL divisions, capable of containing up to 5 mL of gas, terminated with a silicone rubber retaining septum. A suitable arrangement is shown in Fig. 3.

6.1.8 *Reservoir of Mercury*, sufficient to fill the collection flask and collection tube.

NOTE 4—**Caution:** Mercury vapor is extremely toxic. Appropriate precautions should be taken.

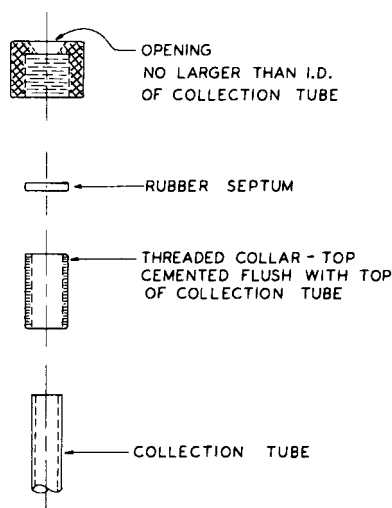

FIG. 3 Retaining Rubber Septum for Gas Collection Tube

7. Sampling

7.1 Obtain samples in accordance with the procedure described in Test Method D 3613 for sampling with syringetype devices or rigid metal cylinders. The use of rigid metal cylinders is not recommended for use with Method B.

7.2 The procurement of representative samples without loss of dissolved gases or exposure to air is very important. It is also important that the quantity and composition of dissolved gases remain unchanged during transport to the laboratory. Avoid prolonged exposure to light by immediately placing drawn samples into light-proof containers and retaining them there until the start of testing.

7.2.1 To maintain the integrity of the sample, keep the time between sampling and testing as short as possible. Evaluate containers for maximum storage time. Samples have been

stored in syringes and metal cylinders for four weeks with no appreciable change in gas content.

NOTE 5—Additional sampling procedures using flexible metal cans are currently being studied for use with Method A.

METHOD A—VACUUM EXTRACTION

8. Method A—Vacuum Extraction

8.1 Method A employs vacuum extraction to separate the gases from the oil. The evolved gases are compressed to atmospheric pressure and the total volume measured. The gases are then analyzed by gas chromatography.

9. Preparation of Apparatus

9.1 Check the apparatus carefully for vacuum tightness of all joints and stopcocks.

9.2 Measure the total volume of the extraction apparatus, V_T , and the volume of the collection space, V_c , and calculate the ratio as the volumetric collection ratio:

$$\frac{V_c}{V_T - V_o} \quad (1)$$

where V_o = the volume of oil to be added.

9.3 Calculate the degassing efficiencies for each individual component gas as follows:

$$E_i = \frac{1}{1 + \frac{K_i V_o}{V_T - V_o}} \quad (2)$$

where:

E_i = degassing efficiency of component i ,

V_o = volume of oil sample,

V_T = total internal volume of extraction apparatus before oil sample is introduced, and

K_i = Ostwald solubility coefficient of component i .

9.4 Determine the Ostwald solubility coefficients of fixed gases in accordance with Test Method D 2780.

9.5 Ostwald solubility coefficients that have been determined for a number of gases in one specific electrical insulating oil at 25°C are shown as follows. Values for gases in other oils may be estimated by reference to Test Method D 2779.

Component Gas	Ostwald Solubility ⁸ (Note 6) Coefficient, K_i , 25°C, 760 mm Hg
Hydrogen	0.0558
Nitrogen	0.0968
Carbon monoxide	0.133
Oxygen	0.179
Methane	0.438
Carbon dioxide	1.17
Acetylene	1.22
Ethylene	1.76
Ethane	2.59
Propane	11.0

NOTE 6—The Ostwald coefficient values shown in this table are correct only for the specific mineral oil having a density at 15.5°C of 0.855 g/cm³ used in the original determination. Ostwald coefficients for mineral oils of different density may be calculated as follows:

$$K_i \text{ (corrected)} = K_i \frac{0.980 - \text{density}}{0.130} \quad (3)$$

⁸ “Analysis of Gas Dissolved in Transformer Oils;” Daoust, R., Dind, J. E., Morgan, J., and Regis, J.; Doble Conference, 1971, Sections 6–110.

where, *density* = density of the oil of interest, g/cm³ at 15.5°C (60°F). This equation is derived from the equation in Test Method D 2779. Note especially that all of the Ostwald coefficients are changed by the same factor, meaning that though the absolute solubilities of each of the gases will change if a different oil is used, the ratio of the solubility of one gas to another gas will remain constant.

9.6 A procedure to check the extraction efficiency requires the use of prepared gas-in-oil standards of known concentration. The methods of preparation are outlined in Annex A1 and Annex A2.

10. Procedure

10.1 Lower the mercury level from the collection flask.

10.2 Evacuate the system of collection flask and degassing flask to an absolute pressure of 1×10^{-3} torr (130 mPa) or less. (In Fig. 1, the space above the mercury in the reservoir must also be evacuated.)

10.3 Connect the oil sample syringe by the PTFE tubing to the three-way stopcock leading to the degassing flask.

10.4 Flush a small quantity of oil from the syringe through the tubing and stopcock to waste, making sure that all the air in the connecting tubing is displaced by oil.

10.4.1 Any gas bubbles present in the syringe should be retained during this flushing operation. This may be accomplished by inverting the syringe so that the bubble remains at the plunger end of the syringe during the flushing operation.

10.5 Close the stopcocks to the vacuum pumps and then slowly open the three-way stopcock to allow oil and any gas bubbles that may be present from the sample syringe to enter the degassing flask.

10.6 Allow the desired amount of oil to enter the degassing flask and operate the magnetic stirrer vigorously for approximately 10 min. This is the volume, V_o used in the calculation in 15.4.

10.6.1 If a gas bubble is present in the syringe, either analyze the total content of the syringe including the bubble; or, if the gas bubble is large, and it is suspected that the concentration of dissolved gases is high, measure and analyze the gas bubble separately, extract an aliquot of the oil sample, and correct as applicable.

10.7 Close the stopcock isolating the collection flask, and allow mercury to flow into the collection flask.

10.8 Open the stopcock to the reference column and by means of the hand pump (Fig. 1) or leveling bottle (Fig. 2) bring the level of the mercury in the reference column even with the level in the collection tube.

10.9 Measure the volume of extracted gas in the collection tube, and correct for collection efficiency by dividing it by the volumetric collection ratio calculated in 9.2. Correct to 760 torr (101.325 kPa) and 0°C. Determine the volume of oil degassed in the degassing flask. Record the gas content as a percentage of the oil by volume.

10.10 Because the total concentration of gas is not extractable from the oil, a rinse step may be required when high quantities are present. The extractor can be rinsed with oil containing nondetectable quantities of gases, except for those present in air. The amount of rinsing needed will be dependent upon the gas concentration, type (solubility in oil), and efficiency of the extractor. To ensure that the combustible gases

have been sufficiently removed from the extractor, the rinse oil may be treated as a sample. General rinse procedures may be established. However, for samples with very high concentrations of gases verify effectiveness of the rinse procedure.

GAS ANALYSIS

11. Apparatus

11.1 *Gas Chromatograph*, consisting essentially of a carrier gas source, a pressure regulator, a sample injection port and chromatography column(s), flow meter(s), detector(s), and recorder(s) or recording integrator(s).

11.2 Provide means for measuring and controlling temperatures of the adsorption column, the inlet port, and the detector to within $\pm 0.5^\circ\text{C}$.

NOTE 7—Use Practice E 260 as a reference for good chromatographic techniques.

11.3 The apparatus shall be capable of sufficiently separating the component gases, at the sensitivity levels shown as follows, to ensure quantitative measurement of the respective peak areas:

Component Gas	Minimum Detection Limits for Gases Dissolved in Oil, ppm
Hydrogen	5
Hydrocarbons	1
Carbon oxides	25
Atmospheric gases	50

11.4 The apparatus shall provide sufficient repeatability so that successive runs of a reference standard agree within $\pm 1\%$ with respect to area under the peaks for hydrocarbon and carbon oxide components.

11.5 A wide range of chromatographic conditions have been successfully employed. Both argon and helium have been used as carrier gases (see Note 8). In some cases, a separate GC or other device is used for the detection and quantification of hydrogen when helium is used as a carrier gas.

NOTE 8—If helium is used as a carrier gas with a thermal conductivity detector, medium to high concentrations of hydrogen may give a nonlinear response, due to the closed heat capacity values of helium and hydrogen. The limit of detection will be higher than with an argon carrier gas under similar conditions. If nitrogen is used as a carrier gas, nitrogen cannot be detected in the sample.

11.5.1 With the use of an argon carrier gas, a catalytic converter containing powdered nickel located after the chromatographic columns is used to convert carbon monoxide and carbon dioxide to methane for detection with a flame ionization detector for acceptable sensitivity. (The condition of the nickel catalyst can be evaluated by checking the linearity of the response to carbon dioxide.) With helium as a carrier gas, a catalytic converter is not necessary but may be used to enhance sensitivity.

11.5.2 A flame ionization detector, instead of a thermal conductivity detector, is often used to detect hydrocarbon gases due to its greater sensitivity for these components. A wide range of injector, column, and detector temperatures can be used. Both isothermal and temperature programs can be used to provide adequate separation and sensitivity. A typical chromatogram is shown in Fig. 4.

11.6 *Fixed Needle Gas-Tight Syringes*,⁹ of suitable sizes are needed for transfer of the gases.

12. Reagent and Materials

12.1 *Purity of Reagents*—Reagent grade chemicals shall be used in all tests. Unless otherwise indicated, it is intended that all reagents shall conform to the specifications of the Committee on Analytical Reagents of the American Chemical Society, where such specifications are available.¹⁰ Other grades may be used, provided it is first ascertained that the reagent is of sufficiently high purity to permit its use without lessening the accuracy of the determination.

12.2 *Suitable Chromatography Columns*—Several combinations have been found to be suitable, including molecular sieve, Porapak Q, Porapak S, diisodecyl phthalate A, Silica Gel J, Chromosorb 102, and Carbosieve B.

12.3 *Helium, Argon, or Nitrogen Carrier Gas*, having a minimum purity of 99.95 mol % (see Note 8).

12.4 *Reference Standard Gas Mixture*, containing known percentages of the gases shown in 11.3.

12.4.1 A round robin performed for this test method showed considerable variation in gas standards when compared to a supplied primary standard. It is strongly recommended that only primary standards (each component prepared gravimetrically) be used. Refer to Practice D 4051 for procedures used to prepare a blend of standard gases. The National Institute of Standards and Technology (NIST) has some gas standards available which can be used to calibrate working standards.¹¹

12.4.2 Individual gases can range from detectable levels to thousands of parts per million in actual samples. However, in most samples the concentration of gases (except oxygen, nitrogen, and carbon dioxide) is tens to hundreds of parts per million. Normally, the gas standard is prepared at concentrations of 5 to 10 times that seen in the oil due to the concentration effect of extracting the gas from the oil and because higher concentrations can be prepared with greater accuracy. Some laboratories use more than one concentration of standards. Acetylene is of greater concern at lower concentration levels than the other hydrocarbon gases.

13. Calibration

13.1 Prepare the gas chromatograph for use as directed by the manufacturer, and establish a set of operating conditions capable of separation of the indicated component gases.

13.2 Inject a pre-established volume of the reference standard gas mixture into the chromatograph and establish a pattern

⁹ Syringes that have been found suitable include those from the Hamilton Co., P.O. Box 307, Whittier, CA 90608; Pressure-Lok Syringes made by Precision Sampling Corp., P.O. Box 15119, Baton Rouge, LA 70815; and Popper and Sons, Inc., 300 Denton Ave., New Hyde Park, NY 11040.

¹⁰ *Reagent Chemicals, American Chemical Society Specifications*, American Chemical Society, Washington, DC. For suggestions on the testing of reagents not listed by the American Chemical Society, see *Analar Standards for Laboratory Chemicals*, BDH Ltd., Poole, Dorset, U.K., and the *United States Pharmacopeia and National Formulary*, U.S. Pharmaceutical Convention, Inc. (USPC), Rockville, MD.

¹¹ Available from U.S. Department of Commerce, National Institute of Standards and Technology, Standard Reference Materials Program, Bldg. 202, Room 204, Gaithersburg, MD 20899.

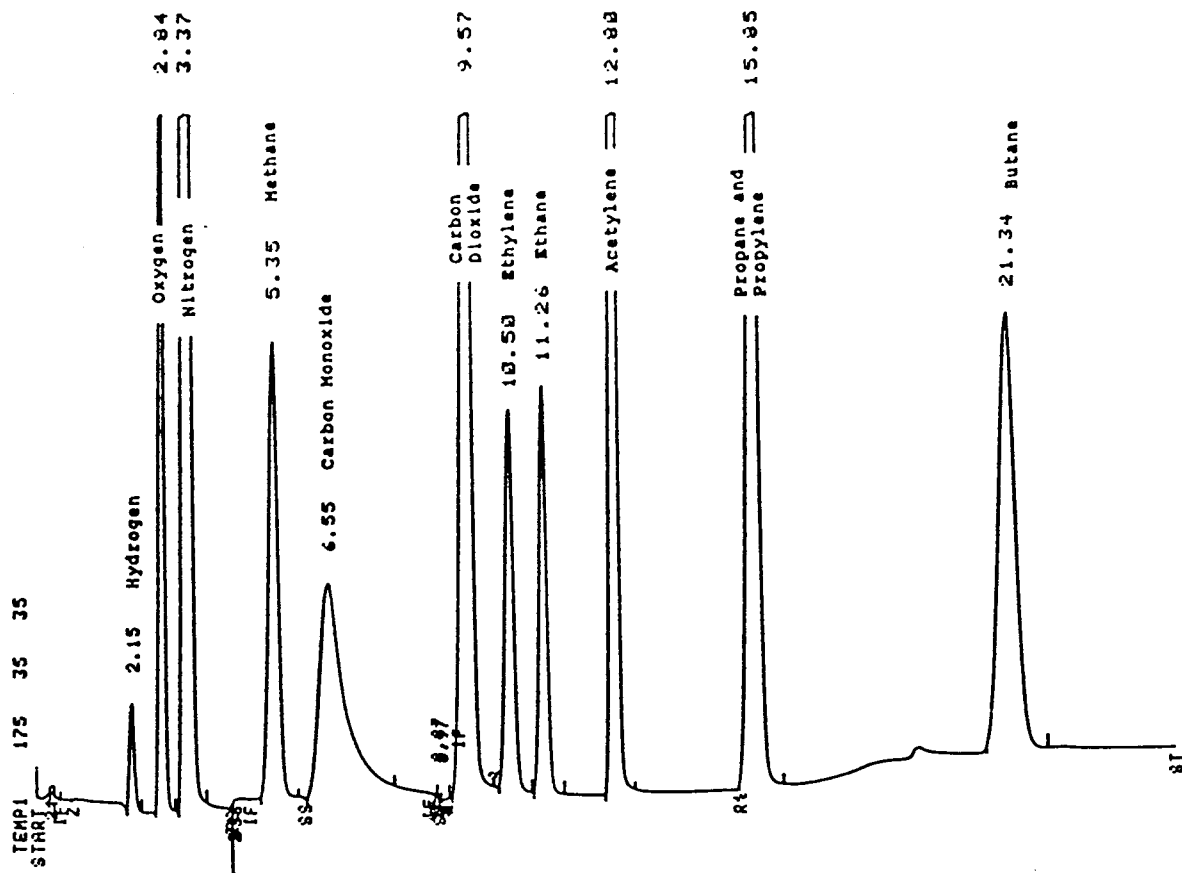

Gas Chromatograph Conditions:

Argon carrier gas, flow rate 30 mL/min

Columns: Porapak N, 80–100 mesh, 13 ft × 1/8 in.
Molecular sieve, 13X, 40–60 mesh, 3 ft × 1/8 in.

Catalytic converter for detection of CO and CO₂

Detectors: Thermal conductivity: H₂, O₂, N₂
Flame ionization: CH₄, CO, CO₂, C₂H₆, C₂H₄, C₂H₂, C₃H₈, C₃H₆, C₄H₁₀
Injection 200°C

Temperatures: TCD 150°C
FID 300°C
Column: Isothermal 35°C for 8 min
35–132°C ramp at 20°C/min, hold until 15.5 min
132–150°C ramp at 25°C/min, hold

NOTE 1—Propane and propylene are not separated under these conditions.

FIG. 4 Sample Chromatogram

of elution times for the gas components known to be in the mixture, at an established set of operating conditions and sample size. Repeat the analysis until consistent operating conditions provide consistent chromatograms as specified in 11.4. Repeat calibration daily when analyses are being conducted.

14. Procedure

14.1 Increase the pressure on the extracted gas contained in the collection tube, described in 6.1.7 to slightly above atmospheric pressure by raising the level of mercury in the reference column slightly above the level of mercury in the gas collection tube.

14.2 Insert the needle of the gas-tight injection syringe through the septum of the collection tube, and withdraw a suitable volume of gas into the syringe. Adjust the gas pressure,

as indicated by the reference column, precisely to atmospheric pressure before closing the syringe or withdrawing the needle from the septum.

14.3 When the apparatus conditions are equal to those established during the calibration procedure, quickly inject the known volume of gas into the chromatograph through the injection port.

14.4 Periodically, chromatography columns require baking out at elevated temperatures. The frequency and duration will depend upon such factors as type of column, amount of use, and concentration of materials tested. Peaks which are not as sharp as usual may be from compounds retained on the column from a previous run, and may indicate a need for baking out the columns. Another indicator that the molecular sieve column needs conditioning is that the methane and carbon monoxide peaks begin to lose baseline separation.

15. Calculation

15.1 Determine the integrated area of each peak of the chromatogram.

15.2 Identify the gases represented by each peak by comparison of elution times with those obtained for the reference standard gas mixture in the calibration procedure.

15.3 Determine the amount of each identified gas component by comparing respective peak areas with those obtained for the reference standard gas mixture in the calibration procedure.

15.4 Calculate the volume concentration of each specific gas with respect to the volume of oil degassed in the degassing flask. Correct to 760 torr (101.325 kPa) and 0°C, and express as parts per million of (specific gas) in oil, by volume.

$$C_i = \frac{V_g A_i C_{si} P_a}{A_{si} V_o} \frac{273 \times 10^4}{760 T_a} \quad (4)$$

where:

- V_g = volume of gas extracted,
- C_i = concentration of gas in ppm, vol/vol,
- A_i = area count or peak height for gas i in sample,
- A_{si} = area count or peak height for gas i in standard,
- C_{si} = concentration of gas i in standard in percent vol/vol,
- V_o = volume of oil,
- P_a = atmospheric pressure, in torr, and
- T_a = ambient temperature, in Kelvin.

15.5 Correct each experimental value obtained in 15.4 for incomplete degassing by dividing each value by its respective degassing efficiency derived from 9.3.

$$\frac{C_i}{E_i} \quad (5)$$

16. Report

16.1 Report the following:

- 16.1.1 Identification of oil sample,
- 16.1.2 Temperature of oil at time of sampling,
- 16.1.3 Gas content of oil by volume, expressed as a percentage,
- 16.1.4 Volume concentration in the oil, for each component gas, expressed in parts per million, and
- 16.1.5 Test method used (for example, D3612, Part A).

17. Precision and Bias

17.1 Precision and bias statements for this test method have not been established but are being developed.

NOTE 9—An interlaboratory test program was conducted in which a total of 50 individual specimens of oil were sampled, at the same time, by the same experienced operator, from a 40 000-L forced-oil-cooled transformer while the transformer was in operation under full load. Individual specimens varying in number from 1 to 8 were shipped to 13 laboratories throughout North America for extraction and analysis of the dissolved gases in accordance with this method. The test results exhibited the coefficients of variation (see Table 1) related to the type of gas and the type of sample container used.

METHOD B—STRIPPER COLUMN EXTRACTION

18. Method B—Stripper Column Extraction

18.1 Dissolved gases are extracted from a sample of oil by sparging the oil with the carrier gas on a stripper column

TABLE 1 Coefficients of Variation

Gas	Syringe	Cylinder	Can
H ₂	34	64	39
O ₂	38	45	74
N ₂	19	45	27
CO	21	74	27
CO ₂	19	42	31
CH ₄	28	50	30
C ₂ H ₆	29	26	28
C ₂ H ₄	21	30	25
C ₂ H ₂	65	33	23
Total	18	33	35

containing a high surface area bead. The gases are then flushed from the stripper column into a gas chromatograph for analysis. Testing of silicone liquids by this test method is not recommended for systems which are also used to test mineral oil, as excessive foaming should cause contamination of columns after the stripper.

19. Apparatus

19.1 *Gas Chromatograph*,¹² capable of separating and detecting the gases of interest using a direct injection of a portion of the liquid samples. Alternative gas strippers are given in IEC Method 567.

19.2 The apparatus must be capable of sufficiently separating the component gases, at the sensitivity levels shown as follows, to ensure quantitative measurement of the respective peak areas:

Component Gas	Minimum Detection Limits for Gases Dissolved in Oil, ppm
Hydrogen	20
Hydrocarbons	1
Carbon oxides	2
Atmospheric gases	500

The limit of detection for hydrogen specified in Method B is higher than that specified for Method A. This could affect the interpretation of results when low levels of gases are present.

19.3 The apparatus shall be capable of providing data for successive runs of a reference standard that are repeatable within 1 %, with respect to area under the peaks, for hydrogen and carbon oxide components.

20. Reagent and Materials

20.1 *Suitable Chromatography Columns*—Several combinations have been found to be suitable including molecular sieve, Porapak Q, Porapak N, diisodecyl phthalate A, Silica Gel J, Chromosorb 102, Carbosieve B, and Sperocarb. Molecular sieve is used to separate H₂, O₂, N₂, CH₄, and CO. Porapak N, Q, or combinations of both are used to separate CO₂, C₂H₄, C₂H₆, C₂H₂, C₃H₆, C₃H₈, and C₄H₁₀. Sperocarb is used to separate the carbon oxide and hydrocarbon gases.

20.2 *Argon, or Nitrogen Carrier Gas*, having a minimum purity of 99.95 mol % with total hydrocarbons of less than 0.5 ppm and CO₂ of less than 1 ppm. (See Note 8.)

20.2.1 With the use of an argon carrier gas, a catalytic converter containing powdered nickel, located after the separating columns, is used to convert carbon monoxide and carbon

¹² Suitable equipment includes that from Shimadzu Scientific Instruments, Inc., 7102 Riverwood Road, Columbia, MD. This equipment uses a patented process for the sparger.

 **D 3612**

dioxide to methane for detection with a flame ionization detector for acceptable sensitivity. (The condition of the nickel catalyst can be evaluated by checking the linearity of the response to carbon dioxide.)

20.3 *Flame Ionization Detector Gases*—Hydrogen having a purity of 99.99 mol % with total hydrocarbons of less than 0.5 ppm and air having a purity of less than 1 ppm total hydrocarbons.

20.4 *Reference Standard Gas Mixtures*—Low-concentration standard containing known percentages of the gases in 1.2 at concentrations approximately the magnitude of the values normally encountered. The high-concentration gas standard should contain levels approximately one order of magnitude higher than contained in the low-concentration gas standard. The gas standards should be a primary grade (each component added gravimetrically). The high gas standard is used for preparing gas in oil standards as outlined in Annex A1.

21. Calibration (Gases)

21.1 Prepare the gas chromatograph for use as directed by the manufacturer, and establish a set of operating conditions capable of separating the indicated component gases.

21.2 Inject a preestablished volume of the reference standard (low concentration) gas mixture into the chromatograph and establish a pattern of elution times for the gas components known to be in the mixture, at an established set of operating conditions and sample sizes. Repeat the analysis until consistent operating conditions provide consistent chromatograms. Repeat calibration daily when analyses are being conducted.

22. Efficiency Determination

22.1 Inject the oil standard prepared from one of the procedures in the Annexes into the system. Determine the dissolved gas content of this oil chromatographically based upon the low-concentration gas standard. The difference between the calculated concentration and the observed concentration is the degassing efficiency of a given component and may be calculated as follows:

$$D_i(C_{aoi} - C_{boi}) / C_{oi} \quad (6)$$

where:

D_i = degassing efficiency of component i ,

C_{aoi} = observed concentration of component i in the oil standard,

C_{boi} = observed concentration of component i in the blank oil, and

C_{oi} = calculated concentration of component i in the oil standard.

22.2 The degassing efficiency factor is used to correct the determined concentration values for incomplete extraction. Repeat the procedure until consistent results are obtained. Conduct this efficiency determination weekly for at least one concentration of standard gas. Whenever there are changes in the chromatographic system, redetermine the extraction efficiency.

22.3 Determine the linearity of the detector response monthly by testing a range of gas concentrations expected to be encountered in actual samples. Extraction efficiencies should also be determined over a corresponding range to ensure they

are linear and constant over time. Samples can be prepared by simple dilution of pure gases with either nitrogen or carrier gas (for gas standards) or degassed oil (for gas-in-oil standards). If commercially supplied standard mixtures are used, they may be checked using this method. Check efficiencies and linearity whenever chromatographic conditions are changed.

23. Procedure for Direct Injection

23.1 Prepare the gas chromatograph as outlined by the manufacturer.

23.2 Prepare the sample for injection by first dissolving any gas bubble present into the volume of oil by compressing the plunger into the barrel of the syringe and agitating the gas by tipping the syringe up and down. Any bubble present in the syringe must be dissolved to obtain a representative aliquot of the sample for injection. Small volumes of oil are needed for flushing and sample, typically a total of several millilitres. Flushing is required to displace the previous sample from the column.

23.3 Once the sample is connected to the gas chromatograph, flush enough oil through the injection system to ensure that no gas bubbles remain in the line.

23.4 If high concentrations of the more soluble gases are found, in particular C_2H_2 , the injection column can be back flushed. Use a blank run of degassed insulating oil to check that no residual gases remain.

24. Calculation

24.1 Determine the integrated area of each peak of the chromatogram.

24.2 Identify the gases represented by each peak by comparison of elution times with those obtained for the reference standard gas mixture in the calibration procedure.

24.3 Determine the amount of each identified gas component by comparing respective peak areas with those obtained for the reference standard gas mixture in the calibration procedure.

24.4 Correct the values obtained based on the efficiency values obtained in the efficiency determination procedure, and express as parts per million of (specific gas) in oil, by volume as shown in the following calculation:

$$C_{ci} = C_{aoi} / D_i \quad (7)$$

where:

C_{aoi} = observed concentration of component i in the oil sample, and

C_{ci} = corrected concentration of component i in the oil sample.

24.5 Estimate the total gas content in oil by volume by summing the concentration of all of the individual gases detected. The error in this calculation occurs when gases present are not detected and therefore not included. The total gas content is determined by a different technique than given in Method A, but the results are usually similar.

25. Report

25.1 Report the following information:

25.1.1 Identification of oil sample,

25.1.2 Temperature of oil at time of sampling,

25.1.3 Volume concentration in the oil, for each component gas, expressed in parts per million, and

25.1.4 The test method used (for example, D3612, Part B).

26. Precision and Bias

26.1 A round-robin is being run to determine the precision and bias of this test method. An interim statement of repeatability for two laboratories is provided in Annex A3.

METHOD C—HEADSPACE SAMPLING

27. Method C—Headspace sampling

27.1 Method C consists of bringing an oil sample in contact with a gas phase (headspace) in a closed vessel purged with argon. As a result, a portion of a gas (H_2 , O_2 , N_2 , CH_4 , CO , CO_2 , C_2H_2 , C_2H_4 , C_2H_6 , or C_3H_8) of concentration C_L^o dissolved in oil is transferred to the headspace. At equilibrium, the relationship between the remaining concentration of a gas in the oil (C_L), its concentration in the headspace (C_G), and its initial concentration in the oil (C_L^o) may be deduced by mass equivalence as follows:

$$C_L^o V_L = C_L V_L + C_G V_G \quad (8)$$

where:

V_L = volume of the oil sample, and

V_G = volume of the headspace.

There is a direct proportionality between the concentration of this gas in the two phases in equilibrium as follows:

$$C_L = K C_G \quad (9)$$

where:

K = partition coefficient.

By substituting C_L in Eq 8 by its expression from Eq 9, the mass equivalence relationship becomes:

$$C_L^o V_L = K C_G V_L + C_G V_G \quad (10)$$

and based on this equation, C_L^o can be extracted as follows:

$$C_L^o = C_G \left(K + \frac{V_G}{V_L} \right) \quad (11)$$

Eq 11 forms the basis of the headspace sampling method and shows that the initial concentration of a dissolved gas in oil may be determined by analyzing an aliquot portion of the headspace when equilibrium is reached. This operation involves the following two steps:

27.1.1 *Step 1 at Time = 0*—The oil sample to be analyzed of a volume, V_L , containing a dissolved gas at a concentration, C_L^o is placed in a purged vial of a set total volume V . The vial is maintained at a constant temperature under mechanical agitation until thermodynamic equilibrium between the oil sample and the headspace is reached.

27.1.2 *Step 2 at Equilibrium*—The concentration of the gas in the oil sample and its concentration in the gas phase are C_L and C_G , respectively. The headspace is then overpressurized with argon and the content of a loop is filled by the depressurization of the headspace against the ambient atmospheric pressure. The gases contained in the loop are then introduced into a gas chromatograph.

28. Apparatus

28.1 *Headspace Sampler*, equipped with an injection loop

and a transfer line connected directly to the first column of the gas chromatograph. The sampler must be capable of equilibrating the species of interest in a specific time. The required equilibration time can be minimized by mixing the sample during the equilibration period, and this can be achieved by using a sampler equipped with mechanical shaking.

28.2 *Gas Chromatograph*, equipped with a bypass valve, an adjustment restrictor, a universal nondestructive thermal conductivity detector (TCD), and a flame ionization detector (FID). The permanent gases H_2 , O_2 , and N_2 are detected using the TCD, while the FID is used for detection of hydrocarbons and carbon oxides.

28.3 *Molecular Sieve*, 5 Å PLOT column (30-m by 0.53-mm inside diameter with a film thickness of 50 μ m) for the separation of the lighter gases (H_2 , O_2 , N_2 , CH_4 , and CO).

NOTE 10—The molecular sieve column used should be able to resolve at the baseline all the gases of interest.

28.4 *Carboxen-1006 PLOT Column* (30-m by 0.53-mm inside diameter) for the separation of the other compounds (CO_2 , C_2H_2 , C_2H_4 , C_2H_6 , and C_3H_8).

NOTE 11—Packed columns that give adequate peak separation may also be used with this method. In that case, the analytical performance may be somewhat different than that specified in Method C.

28.5 *Catalytic Converter*, containing powdered nickel installed between the TCD and the FID, for the conversion of CO and CO_2 into CH_4 for a sensitive recording of the signal by the FID.

28.6 *Zero-dead Volume Adapter*, for the column connections (0.53-mm inside diameter).

28.7 *Headspace Glass Vials*, of 20-mL nominal capacity. The exact volume of these vials should be estimated by performing the procedure in accordance with 30.1.

28.8 *Crimping System*, including crimp head and a decapper head.

28.9 *Perforated Aluminum Caps*.

28.10 *TFE-fluorocarbon Faced Butyl Septa* for headspace vials.

28.11 *Glass Syringes*, 30-mL equipped with three-way plastic stopcocks.

NOTE 12—The variation in the oil delivery volume of the 30-mL syringes should be verified by the laboratory. The analytical performance of Method C was established with a delivery volume variation of 1.9 % (%RSD over 20 syringes from different batches).

28.12 *Needles*, 18G1 and 26G½.

28.13 *Pressure Regulators*, two-stage, with a delivery pressure adjusted at 20.7 Kpa (3 psi) for the cylinders containing the argon and the calibrating gases.

The diagram of the test assembly is shown in Fig. 5 and the instrumental conditions are given in Table 2. The system must be capable of sufficiently separating the component gases at the sensitivity levels in accordance with 11.3 of Method A. An example of the detection limits achieved by one laboratory with a 3-mL injection loop and capillary columns is given in Table 3. Fig. 6 presents a typical chromatogram recorded in accordance with the conditions given in Table 2 for an oil sample collected from an open-breathing transformer with 6.0 % total gas content.

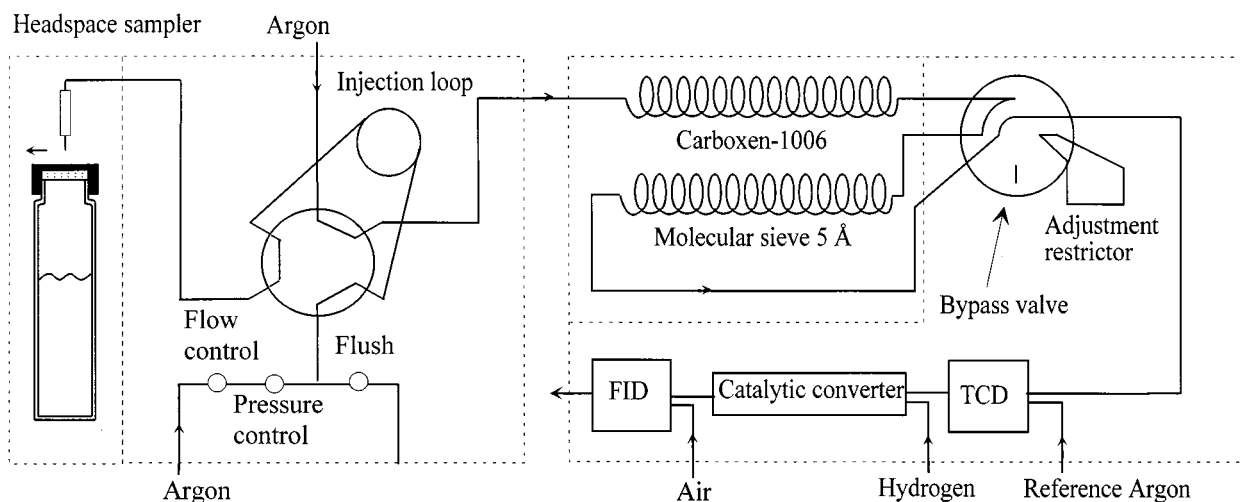

FIG. 5 Diagram of the Test Assembly (waiting mode representation).

TABLE 2 Instrumental Conditions

Headspace Sampler		Gas Chromatograph	
Temperatures:	Sample 70°C	-bypass valve	120°C
	Transfer line 150°C	-FID	250°C
	Injection valve 150°C	-TCD	250°C
		-catalytic converter	350°C
Pressure:	vial overpressure 70 KPa (0.7 bar)		
Times:	equilibration at 70°C with shaking 30 min	-oven	40°C for 3 min
	pressurization 0.25 min		24°C/min to 170°C for 2 min
	pressure equilibrium 0.25 min		24°C/min to 250°C for 5 min
	expansion in injection loop 0.25 min	bypass valve:	0-4 min
	injection 0.90 min	(indicative values)	4-11 min
Shaking power:	Maximum level		11-13 min
Carrier gas:	Argon @ 12 mL/min		13 min to the end
			columns in series
			molecular sieve bypassed
			columns in series
			molecular sieve bypassed

TABLE 3 Detection Limits in ppm (signal/noise = 3)

H ₂	0.6
O ₂	11.0 ^A
N ₂	11.2
CH ₄	0.06
CO	0.09
CO ₂	0.1
C ₂ H ₂	0.05
C ₂ H ₄	0.04
C ₂ H ₆	0.04
C ₃ H ₈	0.2

^AEstimated from the H₂ response.

NOTE 13—The detection limits shown in Table 3 were obtained from the analysis of a dissolved-gas standard of 1 ppm for all gases, except for O₂, N₂, CO, and CO₂, where the concentration was 17, 24, 1.6, and 8.8 ppm, respectively. These results were obtained with a headspace sampler coupled with a gas chromatograph of one commercial source; other devices can be used but the analytical performance may be somewhat different than that specified in Method C.

29. Chemicals

29.1 *Argon, Air, and Hydrogen Cylinders*, 99.999 % pure. Argon is used to overpressurize the headspace and to carry the substances contained in the injection loop through the stationary phase to the detectors.

29.2 *Three Gas Mixtures*, prepared with a precision of about 0.5 % used to establish a three-point calibration curve for each

substance. The concentrations of these mixtures should be chosen in order to fully cover the expected concentration range of field samples, which depends on the type of equipment monitored.

30. Procedure

30.1 *Headspace Vial Volume Determination*—Because of the importance of the V_G/V_L phase ratio factor in the concentration calculation (Eq 11), the following vial volume determination procedure must be applied to detect any variation from batch to batch and manufacturer to manufacturer.

30.1.1 Equilibrate at the ambient laboratory temperature about 20 vials from every batch and 500 mL of water and note the temperature. The vials should be preferably selected from the different packs received from a batch.

30.1.2 Determine the weight of each vial with an accuracy of 0.01 g. Fill each vial completely with water (the vial should be filled to the point where the water surface is flat and in line with the edge of the vial, that is, no meniscus), and reweigh the vial with an accuracy of 0.01 g.

30.1.3 Calculate the volume of each vial using the following equation:

$$V = \frac{W_w - W_e}{D_w} \quad (12)$$

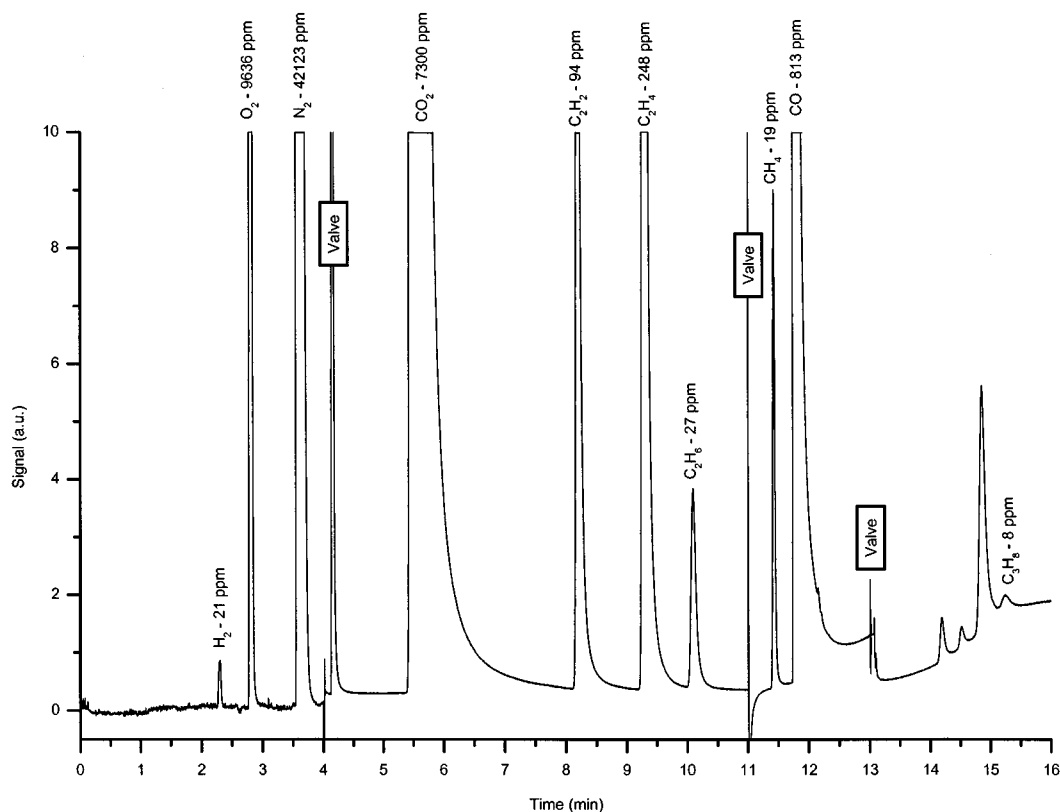

FIG. 6 Typical Chromatogram

where:

- V = volume of the vial,
- W_W = weight of the vial filled with water,
- W_E = weight of the empty vial, and
- D_W = density of the water at the ambient laboratory temperature.

30.1.4 Calculate the mean volume and the standard deviation over the twenty vials from every batch. Use the mean volume to determine precisely V_G of the phase ratio used in Eq 11.

NOTE 14—The analytical performance of Method C was established with a volume variation less than 0.7 % (%RSD over 20 vials) for vials from the same batch.

30.2 Headspace Vial Preparation:

30.2.1 Using an appropriate tool, seal a series of 20-mL vials using perforated aluminum caps fitted with a TFE-fluorocarbon-faced butyl septum. Ensure that the lined side is turned towards the inside of the vial and check that the vial is properly sealed by trying to turn the cap. If the cap is not tightly fixed, repeat the process. These vials will be used to perform 30.2.2 and 30.3.

30.2.2 Insert two 18G1 needles through the vial septum at different peripheral locations, one to be used as the inlet gas and the other as the outlet gas. Purge each vial with argon at a rate of about 2 L/min for at least 30 s. First remove the outlet needle and then the inlet needle. (This sequence allows pressure to build up inside the vial). These vials will be used in 30.4.

NOTE 15—**Caution:** For safety consideration, the argon cylinder should be equipped with a two-stage regulator with a delivery pressure

adjusted at 20.7 Kpa (3 psi) to limit the overpressure built up in the vial. The regulator should be purged with argon before proceeding with 30.2.2.

30.3 Calibration—The calibration curves are obtained as follows:

30.3.1 Insert two 18G1 needles through the vial septum at different peripheral locations, one to be used as the calibration inlet gas and the other as the outlet gas. Purge one vial with each calibration gas mixture at a rate of about 2 L/min for at least 30 s. First remove the outlet needle and then the inlet needle. (This sequence allows pressure to build up inside the vial.) The vial pressure is then equilibrated at the ambient pressure by inserting a 26G½ needle for a very short period of time (1 to 2 s).

NOTE 16—**Caution:** For safety consideration, the calibrating gas cylinders should be equipped with a two-stage regulator with a delivery pressure adjusted at 20.7 Kpa (3 psi) to limit the overpressure built up in the vial. The regulator should be purged with calibrating gas mixture before proceeding with 30.3.1.

30.3.2 Place the vials inside the headspace sampler and begin the analysis using the instrumental conditions given in Table 2. In this specific case, the sample equilibration time at 70°C with shaking could be set at 5 min.

30.3.3 Plot the calibration curves by selecting the appropriate commands in the data acquisition software or any statistical software.

30.3.4 Use a logbook to compile the values of the regression parameters ($y = mx + b$) and the correlation coefficients (R). The system should be recalibrated each day when analysis is being conducted or when the QA/QC program being used indicates an abnormal situation attributed to calibration.

NOTE 17—Achieving calibration every working day ensures identical ambient atmospheric pressure and temperature conditions when filling both the calibration vials and the sample vials. When a QA/QC program is used, the day-to-day variations in the ambient atmospheric pressure and laboratory temperature are covered by the imposed limits of the control charts used for following the day-to-day performance of the system.

30.4 *Analysis of Field Samples*—Introduction of oil samples into vials is performed using glass syringes fitted with three-way plastic stopcocks. The stopcocks used in these procedures have the characteristic that the handle always points toward the closed port leaving the other two ports connected together. Rotation of the valve handle is restricted so that interconnection of all three ports is impossible. When a stainless steel bottle or a flexible-sided metal can is used, an aliquot test specimen should be transferred into a 30-mL glass syringe fitted with a three-way stopcock prior to applying the procedure. Any 30-mL glass syringe sample containing a large bubble should be rejected. For the syringes containing a small bubble (that is, ~0.05 mL), the operator should try to dissolve the bubble by compressing the plunger into the barrel and agitating the gas by tipping the syringe up and down. (Note that a hemispherical bubble of 0.05 mL has a diameter of 5.8 mm when in contact with the glass surface of a syringe.) In the event that it is not possible to dissolve a small bubble, the loss of a low solubility species may be estimated as indicated in the following note.

NOTE 18—Prior to proceeding with 30.4.1, the volume of a small bubble is estimated by measuring the bubble's diameter and converting it into a volume by taking into account the hemispherical distortion that occurs when a bubble is in contact with a glass surface. After the analysis of the dissolved gases, the concentration of a species in a bubble is obtained by using Eq 11, where C_G is the concentration of a species in a bubble in parts per million, K is the Ostwald solubility coefficient of the species (K , 25°C, 760 mm Hg listed in 9.5), V_G the estimated volume of the bubble in millilitres, V_L the volume of oil in the syringe in millilitres, and C_L^o is the concentration of the species in the oil obtained from Section 32 in parts per million. The volume of a species in the bubble in microlitres is obtained by applying the concentration of the species in a bubble over the estimated volume of the bubble. The concentration of a species loss by the oil in parts per million is then obtained by applying the volume of a species in the bubble over the volume of oil contained in the syringe. The resulting value is added to the value obtained in Section 32.

30.4.1 Attach an 18G1 needle to the syringe stopcock.

30.4.2 Insert the needle through the septum at a peripheral location other than for 30.2.2 of a purged vial, which will release the argon overpressure.

30.4.3 Rotate the syringe valve handle a quarter turn and add about 5 mL of oil to the vial. Insert a second 26G½ needle through the septum at a peripheral location other than 30.2.2 and 30.4.2 and fill the vial to about 10 mL. Remove the 26G½ needle and fill the vial to exactly 15-mL by reading the volume on the syringe barrel. Close the three-way valve by turning the handle back towards the syringe. This will allow the vial to equilibrate to atmospheric pressure through the side port of the valve. Finally, withdraw the syringe with its needle attached.

30.4.4 Place the vials in the headspace sampler and begin the analysis using the instrumental conditions given in Table 2.

30.4.5 Process the results by calculating the concentration levels in accordance with the procedure in Section 32.

31. Determination of Partition Coefficients

31.1 The partition coefficients for the different gases being considered are listed in Table 4 at the analytical temperature of 70°C. They were established in the naphthenic Voltesso 35 oil with 12 % of aromatic carbon content (Test Method D 2140) and a negative gassing tendency (Test Method D 2300, Procedure B, H₂ saturating gas). This set of coefficients may be used for measuring fresh or aged oil as well as oil of different compositions.¹³ However, oil with a different composition may have a slight effect on the value of some of these coefficients, which may lead to a decrease in the accuracy of the dissolved gas analysis. The determination of the K 's in the oil being considered and their use for the calculation of the concentrations may ensure maximum accuracy.

31.2 *Procedure*—The equilibrium headspace-gas chromatography/phase ratio variation test method is used to determine the gas-liquid partition coefficients.¹⁴ This test method, performed with the system assembly described in Section 28, is based on the relationship between the partition coefficient and the phase ratio of the vial (ratio of volumes of headspace and sample phase). It comprises the following steps:

31.2.1 Successively collect at least ten 30-mL glass syringes from equipment where all the gases of interest have been detected in the oil. A 1-L dissolved-gas sample prepared in the oil in accordance with the procedure given in Annex A2 of Test Method D 3612 can also be used. In this case, ten aliquots of 30 mL are collected from the oil vessel using a 30-mL glass syringe. The oil samples should be equilibrated at the ambient laboratory temperature to proceed with the following steps.

31.2.2 Attach an 18G1 needle to the syringe plastic stopcock.

31.2.3 Using twenty-five purged vials, prepare five of each of the following volumes, 6, 8, 10, 12, and 14 mL, with the oil contained in the 30-mL syringes and then calculate the corresponding phase ratio (V_G/V_L). Introduce the oil samples into the vials using the procedure described in 30.4.2 and 30.4.3; note that for the oil volumes under 10 mL, there is no need to

¹³ "Dissolved Gas Analysis in Insulating Oils by Controlled Headspace Sampling Coupled with Capillary Gas Chromatography," Gilbert, R., and Jalbert, J., *Proceeding of the 8th BEAMA International Electrical Insulating Conference*, pp. 444-451, 1998.

¹⁴ "Determination of Gas-Liquid Partition Coefficients by Automatic Equilibrium Headspace—Gas Chromatography Utilizing the Phase Ratio Variation Method," Ettre, L.S., Welter, C., and Kolb, B., *Chromatographia*, Vol 35, No. 1/2, pp. 73-84, 1993.

TABLE 4 Partition coefficients of gases in Voltesso 35 at 70°C

Gas	K
H ₂	0.074
O ₂	0.17
N ₂	0.11
CH ₄	0.44
CO	0.12
CO ₂	1.02
C ₂ H ₂	0.93
C ₂ H ₄	1.47
C ₂ H ₆	2.09
C ₃ H ₆	5.04
C ₃ H ₈	5.37
C ₄ H ₆	10.10

D 3612

use a second needle for evacuating the overpressure. The precision is achieved on V_L by weighing each vial before and after the introduction of the oil volume and by converting the weight into volume by using the density of the oil at the ambient laboratory temperature.

31.2.4 Place the vials in the headspace sampler and begin the analysis using the instrumental conditions given in Table 2.

31.2.5 Obtain the peak area of each gas under the different phase ratios. Plot the data in a graph with the reciprocal of the peak area as the Y-axis and the phase ratio as the X-axis.

31.2.6 From the regression analysis of these data, obtain the slope and intercept. From these values, calculate the partition coefficient of the substance: $K = \text{intercept/slope}$.

NOTE 19—The highest accuracy on the K value is obtained when the correlation coefficient (R) of the regression line is better than 0.999. A statistical approach for rejecting any outlier can be used to achieve a correlation coefficient better than 0.999.

31.2.7 Use these partition coefficients to calculate the initial concentration of substance in the selected oil following the procedure given in Section 32.

32. Calculation

32.1 The initial concentration of the substance in oil, C_L^o , is determined using Eq 11 and the partition coefficients given in Table 4. For instance, the hydrogen peak gives an area of 4000 counts, which corresponds to 10 ppm in accordance with the calibration curve that has been plotted. This corresponds to the concentration of hydrogen in the gas phase, C_G . The partition coefficient (K) of hydrogen at the equilibrium temperature is 0.074, $V_G = 5.61$ mL and $V_L = 15$ mL. Hence, in accordance with Eq 11:

$$C_L^o = 10 \text{ ppm} \left(0.074 + \frac{5.61 \text{ mL}}{15 \text{ mL}} \right) = 4.5 \text{ ppm} \quad (13)$$

NOTE 20—In the previous example, it is assumed that the vial used is from a batch with an estimated average volume of 20.61 mL in accordance with the procedure in 30.1.

The C_L^o obtained at the laboratory ambient pressure P_a and temperature T_a are adjusted at 101.325 kPa (760 torr) and 273 K (0°C) by applying the following correction:

$$C_L^o(\text{STP}) = C_L^o \times \frac{P_a}{101.325} \times \frac{273}{T_a} \quad (14)$$

32.2 The total volume of gases in a given volume of oil, expressed as a percentage, is obtained by the sum of the individual gas concentrations expressed in parts per million. For instance, the concentrations obtained from Eq 14 for CO_2 , C_2H_2 , C_2H_4 , C_2H_6 , C_3H_8 , CH_4 , CO , H_2 , O_2 , and N_2 are 7300, 94, 248, 27, 8, 19, 813, 21, 9636, and 42123 ppm, respectively. Hence, the total volume of gas:

$$\% \text{ Gas content} = \sum_{i=1}^n C_{L(i)}^o \times 10^{-4} \quad (15)$$

$$\% \text{ Gas content} = (7300 + 94 + 248 + 27 + 8 + 19 + 813 + 21 + 9636 + 42123) 10^{-4}$$

$$\% \text{ Gas content} = (60289) 10^{-4} = 6.0 \%$$

33. Report

33.1 Report the following information:

33.1.1 Identification of oil sample,

33.1.2 Temperature of oil at time of sampling,

33.1.3 Volume concentration in the oil, for each component gas, expressed in parts per million at 0°C and 760 torr,

33.1.4 The total volume of gases in a given volume of oil expressed as a percentage,

33.1.5 The presence of sizable bubble, and

33.1.6 The test method, (for example, D 3612, Test Method C).

34. Precision and Bias

34.1 A round robin is planned to determine the precision and bias of this test method. An estimate of the repeatability of this test method was obtained from one laboratory by performing the measurement of twelve 15-mL aliquot portions of a sample collected from an open-breathing transformer. The results are given in Table 5. When the accuracy is estimated by one laboratory with dissolved-gas standards of different concentration levels (10, 50, 100, and 175 ppm) prepared in accordance with Annex A2 (no O_2 and N_2 added), the results show that it is possible to obtain an accuracy better than 10 % per constituent.

35. Keywords

35.1 capillary columns; combustible gases; dissolved gases; gases; headspace; insulating oil; oil; transformer oil

TABLE 5 Interim Precision Statement for Repeatability for One Laboratory

Run	H ₂	O ₂	N ₂	CH ₄	CO	CO ₂	C ₂ H ₄	C ₂ H ₆	C ₂ H ₂	C ₃ H ₈	% Gas
#1	21	9636	42123	19	813	7300	248	27	94	8	6.0
#2	20	9727	42306	19	819	7332	248	27	91	9	6.1
#3	20	9906	43632	19	839	7382	251	29	88	9	6.2
#4	17	9847	43288	20	843	7566	262	30	91	9	6.2
#5	20	10303	44100	19	824	7165	242	27	83	9	6.3
#6	22	9483	43011	20	822	8170	281	33	94	9	6.2
#7	21	9831	42619	19	743	7615	262	30	86	9	6.1
#8	24	10588	45971	20	880	7736	264	31	87	9	6.6
#9	20	9865	42422	19	815	7629	262	28	85	9	6.1
#10	14	8964	38558	19	760	7477	266	31	86	9	5.6
#11	21	10636	45149	19	843	7461	255	30	83	9	6.5
#12	23	10612	50340	21	947	7818	261	29	88	9	7.0
Average	20	9950	43627	19	829	7554	258	29	88	9	6.2
SD	3	506	2792	1	52	270	10	2	4	0.3	0.3
RSD, %	13	5	6	4	6	4	4	6	4	3	5.4



ANNEXES

(Mandatory Information)

A1. PREPARATION OF SMALL QUANTITIES OF GAS-IN-OIL STANDARDS (Mandatory Information—Method B)

A1.1 Calibration Apparatus

A1.1.1 *Syringes*, fixed needle gas-tight, of suitable size, and a rubber slip-on septum.

A1.1.2 *Vacuum Pumping System*, capable of evacuating the glassware to an absolute pressure of 1×10^{-3} torr (130 mPa) or lower.

A1.1.3 *Erlenmeyer Vacuum Flask*, 1-L with a glass inlet tube, capable of being evacuated through a vacuum pump, containing a PTFE-coated magnetic spin bar, and a magnetic stirrer.

A1.1.4 *Gas-Tight Chromatography Syringe*, 2.0 mL.

A1.1.5 *Lab Bench Vacuum Pump*, small, attached to 6 in. piece of vacuum tubing containing a needle end.

A1.2 Procedure

A1.2.1 Using a 1-L Erlenmeyer flask attached by vacuum tubing to a mechanical vacuum pump, degas approximately 500 mL of clean oil by stirring the oil under vacuum with a TFE-fluorocarbon stir bar and magnetic stirrer for approximately 2 h, or until no more noticeable air is being drawn out of the oil.

A1.2.2 Rapidly transfer 75 mL of the “blank oil” from the flask to a gas-tight pre-calibrated 100-mL syringe containing a Luer lock valve, breaking vacuum with the same gas as the carrier gas. Air can be used to break vacuum if there is sufficient oil to determine a baseline for oxygen, nitrogen, and carbon dioxide for each syringe. Expel any bubbles that might be present.

A1.2.3 Using the blank oil, determine the quantity of remaining gases in the oil by analyzing an aliquot of the oil from the gas-tight syringe. The 75 mL initial volume provides enough volume for this analysis to be repeated (in some cases 2 or 3 times) to ensure repeatable results.

A1.2.4 Adjust the oil volume in the syringe to 50 mL by holding the syringe vertically with the tip pointed upwards and

insert a slip-on septum on the tip of the syringe.

A1.2.5 Turn the syringe so that the tip is facing downward, and inject 1.0 mL of the high-concentration gas standard taken under known conditions of temperature and pressure into the blank oil through the septum seal contained on the syringe valve. If the “high” gas standard is taken from a pressurized container, the syringe should be filled to capacity and then allowed to bleed down slowly to atmospheric pressure before adjusting to the desired volume. Rapid decompression of a gas sample results in adiabatic cooling leading to an unknown temperature of the gas sample. Record ambient temperature and for use in calculating the concentration of the gas-in-oil standard. The injection is performed using a 2.50 mL gas-tight syringe.

A1.2.6 Shake the syringe with a back and forth motion, while applying a slight positive pressure with the syringe barrel, until the bubble containing gas standard is completely dissolved. The use of a thin, flat washer can facilitate the stirring action and aid in homogenizing the sample.

A1.2.7 Determine the calculated concentration of the gases dissolved in the standard as follows:

$$C_{oi} = V_{sg} (P_a / 760) (273 / T_a) / V_{bo} C_{sgi} 10^4$$

where:

C_{oi} = calculated concentration of component i in the oil, ppm,

P_a = ambient pressure when “high” gas standard sampled,

T_a = ambient temperature when “high” gas standard sampled,

C_{sgi} = concentration of component i in the high concentration gas standard, %,

V_{sg} = volume of the high concentration gas standard, and

V_{bo} = volume of the blank oil.

A2. PREPARATION OF LARGE QUANTITIES OF GAS-IN-OIL STANDARDS (Mandatory Information—Method B)

A2.1 Apparatus

A2.1.1 *Oil Vessel* (Fig. A2.1(a)), 5-L equipped with one sidearm septum holder, two sidearm outlets, one egg-shaped TFE-fluorocarbon-coated stirring bar, a cork ring to support the vessel, and a magnetic stirrer.

A2.1.2 *Oil-Degassing System* (Fig. A2.1(b)), consisting of one 4-L oil reservoir, one 75-mL splash bulb, two high-vacuum stopcocks, one T-type glass connector and a vacuum mechanical pump.

A2.1.3 *Mercury Displacement System* (Fig. A2.1(c)), to compensate for oil volume variations, consisting of two

500-mL glass bulbs, two high-vacuum stopcocks, and one Y-type glass connector.

A2.1.4 *Rigid Stands*, with clamps to secure the various elements, and a large plastic tank to contain accidental mercury spills. All connections between these components are of high-vacuum oil resistant flexible tubing.

A2.1.5 *Gas-Injection System* (Fig. A2.2), consisting of a set of calibrated gas tight syringes of appropriate volumes, a plastic three-way stopcock (standard medical type) modified to minimize dead volumes by inserting pieces of 0.4 mm inside diameter, 1.5 mm outside diameter steel tubing in the inner branches of the barrel and syringe port (filling up with epoxy



(a) Oil Vessel
(b) Set-Up for Degassing Oil
(c) Set-Up for Injecting Gases and Sampling Oil

FIG. A2.1 Apparatus

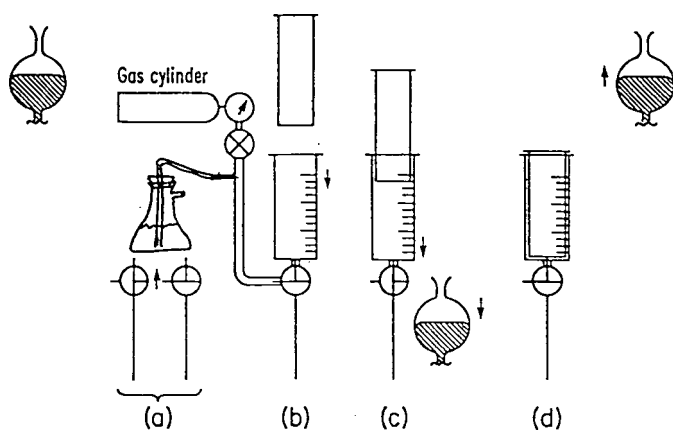

(a) Purging Needle and Valve with Oil
(b) Purging and Filling Gas Syringe with Gas
(c) Injecting Gas Volume in Oil Under Reduced Pressure
(d) Final Syringe Position

FIG. A2.2 Gas-Injection System

resin where necessary), a 0.25-mm inside diameter side-port “gas” injecting needle (10 cm long) to go through the rubber septum into the oil vessel, gas cylinders containing the gases or calibrated gas mixtures to be dissolved in the oil equipped with the proper regulators and valves, a length of flexible tubing connecting the cylinder to the stopcock. A 23-gage needle pierced into this tubing to act as a leak, is connected to a water bubbler to check the absence of back diffusion of air.

A2.1.6 *Oil-Sampling System* (Fig. A2.3), consisting of a 19-gage oil-withdrawing needle (12 cm long), and glass syringes of suitable capacity equipped with two three-way plastic stopcocks.

A2.2 Materials

A2.2.1 Approximately 1 L of clean mercury is needed. Oil-contaminated mercury can be cleaned with pentane and filtered through a finely pierced filter paper.

A2.2.2 *Gases* (H_2 , O_2 , N_2 , CO , CO_2 , CH_4 , C_2H_4 , C_2H_2 , C_3H_6 , etc.) of technical purity, in pressure cylinders, or a mixed commercially prepared primary standard of the gases of interest in appropriate concentrations. The primary standard should have each component prepared gravimetrically.

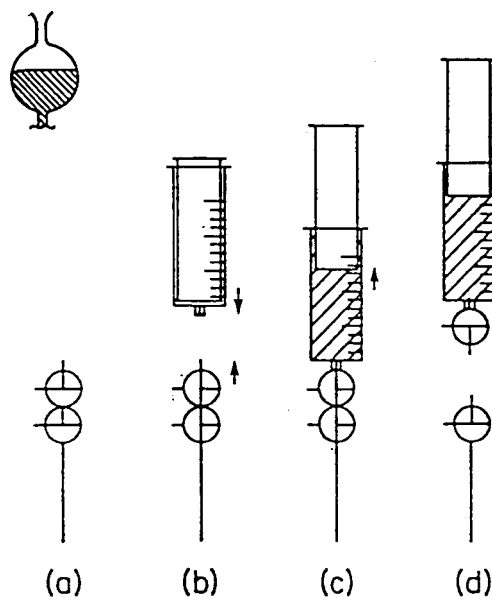

(a) Starting Position
(b) Purging Needle, Valve, and Syringe Tip with Oil
(c) Filling Oil Syringe
(d) Removing Oil Syringe

FIG. A2.3 Oil-Sampling System

A2.2.3 *High-Vacuum Grease*, for stopcocks.

A2.3 Preparation of Apparatus

A2.3.1 Clean all glassware thoroughly, first with detergent, then with a good solvent (methanol, for example), and dry. Pay special attention to the sidearm septum holder. Secure the rubber septum and the flexible connections with pieces of twisted metal wire.

A2.4 Procedure

A2.4.1 *Degassing the Oil* (Fig. A2.1(b)):

A2.4.1.1 Evacuate the splash bulb and the 5-L oil vessel by opening stopcocks 2 and 4.

A2.4.1.2 Fill the reservoir with oil, and allow oil to flow slowly through stopcock 3 in the 5-L oil vessel with stirrer on, until this vessel is full. Close stopcock 2 and remove the oil-degassing system. If the procedure is followed carefully (filling time, about 4 h), the oil in the vessel will be virtually gas-free.

A2.4.2 *Attaching the Mercury-Displacement System* (Fig. A2.1(c)):

A2.4.2.1 Turn the oil vessel to bring it into the position, shown in Fig. A2.1(c). Place a wet cloth over the oil vessel to prevent its temperature from rising and attach the mercury-displacement system to stopcock 1. Introduce 750 mL of mercury into the system so that the mercury level rises just above stopcock 6, then close the stopcock. From stopcock 5, evacuate sections between stopcock 5 and 1. Open 6 to allow mercury to rise up to stopcocks 1 and 5 and then close stopcock 5. Raise the left bulb so that the mercury level is slightly above the oil and open stopcock 1. Remove the wet cloth. Switch on the stirrer.

A2.4.3 *Injection of the Gases* (Fig. A2.1(c) and Fig. A2.2)

ASTM D 3612

Attach the modified three-way stopcock 7 (in the closed position) to the gas-injecting needle. With the mercury level above the oil vessel, push the needle through the rubber septum into the oil (Fig. A2.1(c)).

A2.4.3.1 Open stopcock 7 to purge the needle and stopcock with oil, then close it (Fig. A2.2). Attach to stopcock the barrel of a gas-tight syringe of appropriate volume and the gas cylinder connection tubing (Fig. A2.2(b)).

A2.4.3.2 Allow a gentle flow of gas to flush the barrel, then slowly push the plunger several times into the barrel, finally down to the volume of gas to be injected, making sure there is continuous bubbling through the needle leak.

A2.4.3.3 Switch stopcock 7 to the inject position (Fig. A2.2(c)), lower the mercury level below the needle tip, and push the plunger to inject the gas volume into the oil.

A2.4.3.4 Switch stopcock 7 to the closed position (Fig. A2.2(d)) and raise the mercury bulb above the oil vessel. Depending on the volume and solubility of the gas injected, it takes from a few minutes to several hours to dissolve completely. As the gas dissolves, the mercury-oil interface resumes its original position.

A2.4.3.5 Repeat the same procedure with each of the gases to be dissolved, changing the gas cylinder connection tube. Instead of adding individual gases, it may be convenient to use calibrated gas mixtures. When all the gases have been injected, remove the gas needle stopcock 7.

A2.4.4 *Removal of Oil Samples* (Fig. A2.3):

A2.4.4.1 When all the gases are dissolved, switch off the stirrer. Attach two regular three-way stopcocks in the closed position to the oil withdrawing needle and push the needle through the rubber septum (Fig. A2.3(a)). With the mercury

level up, switch the two three-way stopcocks to the draw-off position (Fig. A2.3(b)) to purge them with oil.

A2.4.4.2 Attach an oil syringe and draw out a suitable volume of oil (Fig. A2.3(c)). Then switch the two three-way stopcocks to the closed position and remove the syringe leaving the upper stopcock (Fig. A2.3(d)). This oil sample is ready for analysis.

A2.4.4.3 To remove several samples of oil, additional mercury may have to be introduced the mercury bulb.

A2.5 Calculation

A2.5.1 Calculate the concentration of each dissolved gas “i” as follows:

$$C_i = \frac{V_i}{V} \times 10^6$$

where:

- C_i = concentration of gas “i”, ppm,
- V_i = volume of gas “i”, injected, mL, (corrected to 0°C (101.325 KPa)),
- V = exact volume of oil in the 5-L oil flask, mL.

A2.6 Precision and Bias

A2.6.1 The main error comes from the measurement of the volume of gas injected V_L which can be obtained with an accuracy of 1 % using calibrated gas-tight syringes. The volume of oil V is obtained more accurately by weighing water in the glass vessel. Correction for dead volume in the injection needle and modified three-way stopcock (approximately 5 mL corresponding to 1 ppm in the dissolved state for the last gas injected) can be made negligible by a last injection of air or nitrogen. The expected overall accuracy therefore is ± 1 %.

A3. INTERIM PRECISION STATEMENT FOR REPEATABILITY BY TWO LABORATORIES

A3.1 Data is given from two laboratories using Method B to determine the concentration of gases in oil. The results are

provided in Table A3.1 and Table A3.2.

TABLE A3.1 Interim Precision Statement for Repeatability for Laboratory 1^A

	Hydrogen	Oxygen	Nitrogen	Methane	Carbon Monoxide	Carbon Dioxide	Ethylene	Thane	Acetylene
Theoretical concentration, ppm	98	2460	16678	74	98	394	74	68	54
Run #1	102	2392	17257	77	99	397	69	65	53
Run #2	110	2257	17125	76	101	396	70	64	52
Run #3	96	2253	16884	77	96	381	67	63	52
Run #4	100	2282	16971	77	98	400	72	68	54
Run #5	98	2273	17213	76	100	397	71	65	53
Average		2291 ^B	17090 ^B						
Standard Deviation (SD)		57 ^B	159 ^B						
RSD,%		1 ^B	2 ^B						
Run #6	105	4254	23588	70	94	367	63	58	47
Run #7	87	3103	17297	70	90	366	63	60	49
Run #8	94	3207	17265	70	89	360	62	58	47
Run #9	87	2770	16998	69	91	364	65	60	48
Run #10	96	3153	16974	69	86	361	60	57	47
Average	98	3297 ^B	18424 ^B	73	94	379	66	62	50
Standard deviation (SD)	7	561 ^B	2890 ^B	4	5	16	4	4	3
RSD,%	7	17 ^B	16 ^B	5	5	4	6	6	5

^A Results given in parts per million (vol/vol) for analysis of two standards of the same concentration of gases in oil tested five times each.

^B The data for these gases was not poolable and is based on the five runs for each sample.

 **D 3612**

TABLE A3.2 Interim Precision Statement for Repeatability of Laboratory 2^A

Trial	Hydrogen	Oxygen	Nitrogen	Methane	Carbon Monoxide	Carbon Dioxide	Ethylene	Ethane	Acetylene
#1	91	5763	40584	105	97	494	72	61	31
#2	48	5425	39989	95	89	458	67	57	28
#3	46	4979	39980	88	84	416	60	51	26
#4	39	4098	34396	86	82	420	60	51	26
#5	52	5372	38555	96	89	467	69	57	29
#6	51	4935	38536	93	88	448	65	54	28
#7	62	4541	38969	97	92	466	68	57	29
#8	52	4630	38690	97	93	471	68	57	29
#9	86	4913	40953	97	95	476	70	58	30
#10	57	4748	39075	95	91	468	69	57	29
Average	58.4	4940.4	38972.7	94.9	90.0	458.4	66.8	56.0	28.5
Standard deviation (SD)	17.0	483.3	1824.7	5.2	4.6	24.4	4.0	3.1	1.6
RSD,%	29	10	5	5	5	5	6	6	6

^A Results given in parts per million (vol/vol) for ten consecutive runs of the same sample.

The American Society for Testing and Materials takes no position respecting the validity of any patent rights asserted in connection with any item mentioned in this standard. Users of this standard are expressly advised that determination of the validity of any such patent rights, and the risk of infringement of such rights, are entirely their own responsibility.

This standard is subject to revision at any time by the responsible technical committee and must be reviewed every five years and if not revised, either reapproved or withdrawn. Your comments are invited either for revision of this standard or for additional standards and should be addressed to ASTM Headquarters. Your comments will receive careful consideration at a meeting of the responsible technical committee, which you may attend. If you feel that your comments have not received a fair hearing you should make your views known to the ASTM Committee on Standards, at the address shown below.

This standard is copyrighted by ASTM, 100 Barr Harbor Drive, PO Box C700, West Conshohocken, PA 19428-2959, United States. Individual reprints (single or multiple copies) of this standard may be obtained by contacting ASTM at the above address or at 610-832-9585 (phone), 610-832-9555 (fax), or service@astm.org (e-mail); or through the ASTM website (www.astm.org).