



Designation: D 1945 – 96 (Reapproved 2001)

Standard Test Method for Analysis of Natural Gas by Gas Chromatography¹

This standard is issued under the fixed designation D 1945; the number immediately following the designation indicates the year of original adoption or, in the case of revision, the year of last revision. A number in parentheses indicates the year of last reapproval. A superscript epsilon (ϵ) indicates an editorial change since the last revision or reapproval.

1. Scope

1.1 This test method covers the determination of the chemical composition of natural gases and similar gaseous mixtures within the range of composition shown in Table 1. This test method may be abbreviated for the analysis of lean natural gases containing negligible amounts of hexanes and higher hydrocarbons, or for the determination of one or more components, as required.

1.2 The values stated in SI units are to be regarded as the standard. The values given in parentheses are for information only.

1.3 *This standard does not purport to address all of the safety concerns, if any, associated with its use. It is the responsibility of the user of this standard to establish appropriate safety and health practices and determine the applicability of regulatory limitations prior to use.*

2. Referenced Documents

2.1 ASTM Standards:

D 2597 Test Method for Analysis of Demethanized Hydrocarbon Liquid Mixtures Containing Nitrogen and Carbon Dioxide by Gas Chromatography²

D 3588 Practice for Calculating Heat Value, Compressibility Factor, and Relative Density (Specific Gravity) of Gaseous Fuels³

E 260 Practice for Packed Column Gas Chromatography⁴

3. Summary of Test Method

3.1 Components in a representative sample are physically separated by gas chromatography (GC) and compared to calibration data obtained under identical operating conditions from a reference standard mixture of known composition. The numerous heavy-end components of a sample can be grouped into irregular peaks by reversing the direction of the carrier gas through the column at such time as to group the heavy ends either as C₅ and heavier, C₆ and heavier, or C₇ and heavier. The composition of the sample is calculated by comparing either the peak heights, or the peak areas, or both, with the corre-

TABLE 1 Natural Gas Components and Range of Composition Covered

Component	Mol %
Helium	0.01 to 10
Hydrogen	0.01 to 10
Oxygen	0.01 to 20
Nitrogen	0.01 to 100
Carbon dioxide	0.01 to 20
Methane	0.01 to 100
Ethane	0.01 to 100
Hydrogen sulfide	0.3 to 30
Propane	0.01 to 100
Isobutane	0.01 to 10
<i>n</i> -Butane	0.01 to 10
Neopentane	0.01 to 2
Isopentane	0.01 to 2
<i>n</i> -Pentane	0.01 to 2
Hexane isomers	0.01 to 2
Heptanes+	0.01 to 1

sponding values obtained with the reference standard.

4. Significance and Use

4.1 This test method is of significance for providing data for calculating physical properties of the sample, such as heating value and relative density, or for monitoring the concentrations of one or more of the components in a mixture.

5. Apparatus

5.1 *Detector*—The detector shall be a thermal-conductivity type, or its equivalent in sensitivity and stability. The thermal conductivity detector must be sufficiently sensitive to produce a signal of at least 0.5 mV for 1 mol % *n*-butane in a 0.25-mL sample.

5.2 *Recording Instruments*—Either strip-chart recorders or electronic integrators, or both, are used to display the separated components. Although a strip-chart recorder is not required when using electronic integration, it is highly desirable for evaluation of instrument performance.

5.2.1 The recorder shall be a strip-chart recorder with a full-range scale of 5 mV or less (1 mV preferred). The width of the chart shall be not less than 150 mm. A maximum pen response time of 2 s (1 s preferred) and a minimum chart speed of 10 mm/min shall be required. Faster speeds up to 100 mm/min are desirable if the chromatogram is to be interpreted using manual methods to obtain areas.

5.2.2 *Electronic or Computing Integrators*—Proof of separation and response equivalent to that for a recorder is required for displays other than by chart recorder. Baseline tracking

¹ This test method is under the jurisdiction of ASTM Committee D03 on Gaseous Fuels and is the direct responsibility of Subcommittee D03.07 on Analysis of Chemical Composition of Gaseous Fuels.

Current edition approved Nov. 10, 1996. Published January 1997. Originally published as D 1945 – 62 T. Last previous edition D 1945 – 91.

² *Annual Book of ASTM Standards*, Vol 05.02.

³ *Annual Book of ASTM Standards*, Vol 05.05.

⁴ *Annual Book of ASTM Standards*, Vol 14.02.

with tangent skim peak detection is recommended.

5.3 *Attenuator*—If the chromatogram is to be interpreted using manual methods, an attenuator must be used with the detector output signal to maintain maximum peaks within the recorder chart range. The attenuator must be accurate to within 0.5 % between the attenuator range steps.

5.4 *Sample Inlet System:*

5.4.1 The sample inlet system shall be constructed of materials that are inert and nonadsorptive with respect to the components in the sample. The preferred material of construction is stainless steel. Copper, brass, and other copper-bearing alloys are unacceptable. The sample inlet system from the cylinder valve to the GC column inlet must be maintained at a temperature constant to $\pm 1^\circ\text{C}$.

5.4.2 Provision must be made to introduce into the carrier gas ahead of the analyzing column a gas-phase sample that has been entrapped in a fixed volume loop or tubular section. The fixed loop or section shall be so constructed that the total volume, including dead space, shall not normally exceed 0.5 mL at 1 atm. If increased accuracy of the hexanes and heavier portions of the analysis is required, a larger sample size may be used (see Test Method D 2597). The sample volume must be reproducible such that successive runs agree within 1 % on each component. A flowing sample inlet system is acceptable as long as viscosity effects are accounted for.

NOTE 1—The sample size limitation of 0.5 mL or smaller is selected relative to linearity of detector response, and efficiency of column separation. Larger samples may be used to determine low-quantity components to increase measurement accuracy.

5.4.3 An optional manifold arrangement for entering vacuum samples is shown in Fig. 1.

5.5 *Column Temperature Control:*

5.5.1 *Isothermal*—When isothermal operation is used, maintain the analyzer columns at a temperature constant to 0.3°C during the course of the sample run and corresponding reference run.

5.5.2 *Temperature Programming*—Temperature programming may be used, as feasible. The oven temperature shall not exceed the recommended temperature limit for the materials in the column.

5.6 *Detector Temperature Control*—Maintain the detector temperature at a temperature constant to 0.3°C during the course of the sample run and the corresponding reference run. The detector temperature shall be equal to or greater than the maximum column temperature.

5.7 *Carrier Gas Controls*—The instrument shall be equipped with suitable facilities to provide a flow of carrier gas through the analyzer and detector at a flow rate that is constant to 1 % throughout the analysis of the sample and the reference standard. The purity of the carrier gas may be improved by flowing the carrier gas through selective filters prior to its entry into the chromatograph.

5.8 *Columns:*

5.8.1 The columns shall be constructed of materials that are inert and nonadsorptive with respect to the components in the sample. The preferred material of construction is stainless steel. Copper and copper-bearing alloys are unacceptable.

5.8.2 An adsorption-type column and a partition-type column may be used to make the analysis.

NOTE 2—See Practice E 260.

5.8.2.1 *Adsorption Column*—This column must completely separate oxygen, nitrogen, and methane. A 13X molecular sieve 80/100 mesh is recommended for direct injection. A 5A column can be used if a pre-cut column is present to remove interfering hydrocarbons. If a recorder is used, the recorder pen must return to the baseline between each successive peak. The resolution (R) must be 1.5 or greater as calculated in the following equation:

$$R(1,2) = \frac{x_2 - x_1}{y_2 + y_1} \times 2, \quad (1)$$

where x_1 , x_2 are the retention times and y_1 , y_2 are the peak widths. Fig. 2 illustrates the calculation for resolution. Fig. 3 is a chromatogram obtained with an adsorption column.

5.8.2.2 *Partition Column*—This column must separate ethane through pentanes, and carbon dioxide. If a recorder is used, the recorder pen must return to the base line between each peak for propane and succeeding peaks, and to base line within 2 % of full-scale deflection for components eluted ahead of propane, with measurements being at the attenuation of the

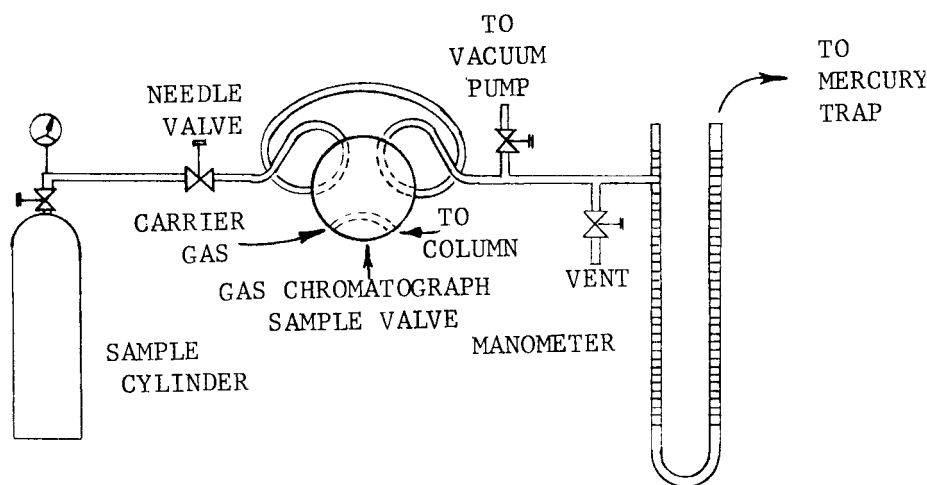

FIG. 1 Suggested Manifold Arrangement for Entering Vacuum Samples

ASTM D 1945

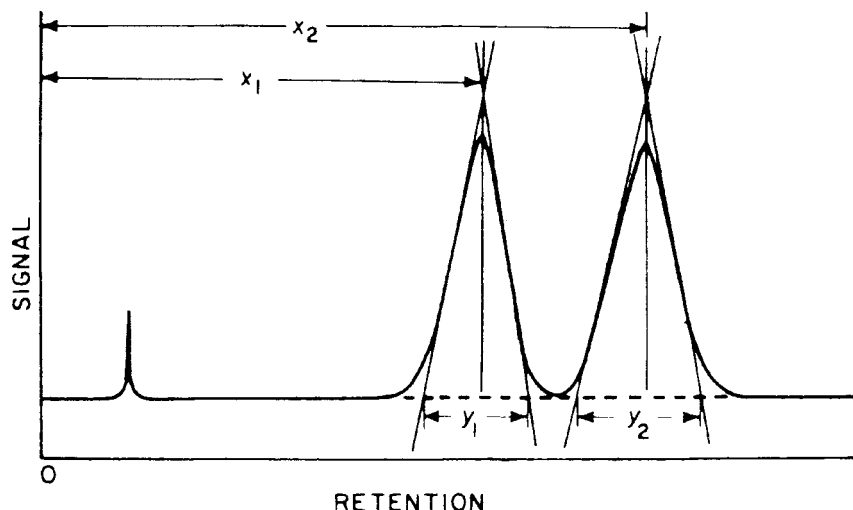
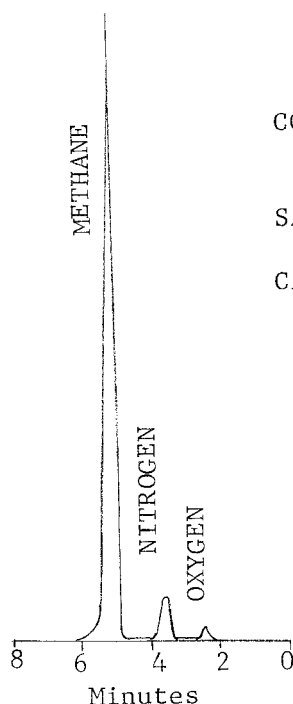

FIG. 2 Calculation for Resolution



COLUMN: 2 meter Type 13X molecular sieve, 80-100 mesh

SAMPLE SIZE: 0.25 mL.

CARRIER GAS: Helium @ 30 mL./min.

FIG. 3 Separation Column for Oxygen, Nitrogen, and Methane (See Annex A2)

peak. Separation of carbon dioxide must be sufficient so that a 0.25-mL sample containing 0.1-mol % carbon dioxide will produce a clearly measurable response. The resolution (R) must be 1.5 or greater as calculated in the above equation. The separation should be completed within 40 min, including reversal of flow after n -pentane to yield a group response for hexanes and heavier components. Figs. 4-6 are examples of chromatograms obtained on some of the suitable partition columns.

5.8.3 *General*—Other column packing materials that provide satisfactory separation of components of interest may be used (see Fig. 7). In multicolumn applications, it is preferred to use front-end backflush of the heavy ends.

NOTE 3—The chromatograms in Figs. 3-8 are only illustrations of typical separations. The operating conditions, including columns, are also

typical and are subject to optimization by competent personnel.

5.9 *Drier*—Unless water is known not to interfere in the analysis, a drier must be provided in the sample entering system, ahead of the sample valve. The drier must remove moisture without removing selective components to be determined in the analysis.

NOTE 4—See A2.2 for preparation of a suitable drier.

5.10 *Valves*—Valves or sample splitters, or both, are required to permit switching, backflushing, or for simultaneous analysis.

5.11 *Manometer*—May be either U-tube type or well type equipped with an accurately graduated and easily read scale covering the range 0 to 900 mm (36 in.) of mercury or larger. The U-tube type is useful, since it permits filling the sample

ASTM D 1945

COLUMN-25% BMEE on Chromosorb P,
7 meters @ 25°C
CARRIER GAS: Helium @ 40 mL./min.
SAMPLE SIZE: 0.25 mL.

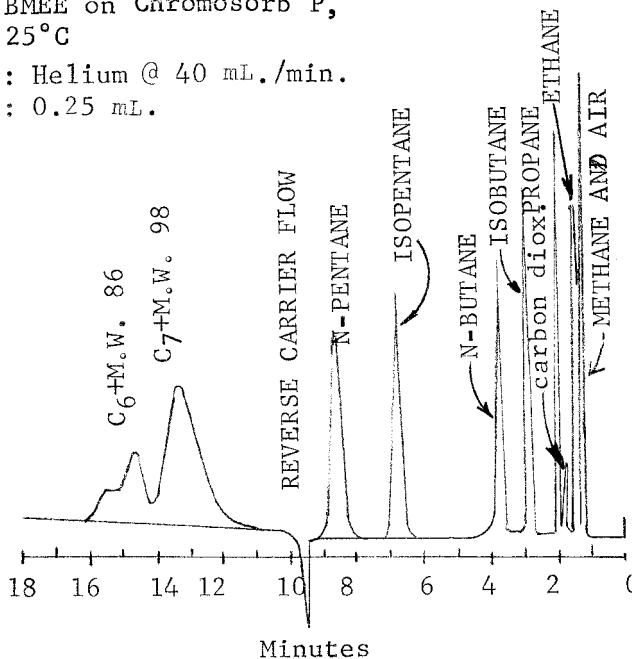

FIG. 4 Chromatogram of Natural Gas (BME Column) (See Annex A2)

COLUMN: Chromosorb PAW, 200/500, 10m
CARRIER GAS: Helium @ 40 mL./min.
SAMPLE SIZE: 0.25 mL.

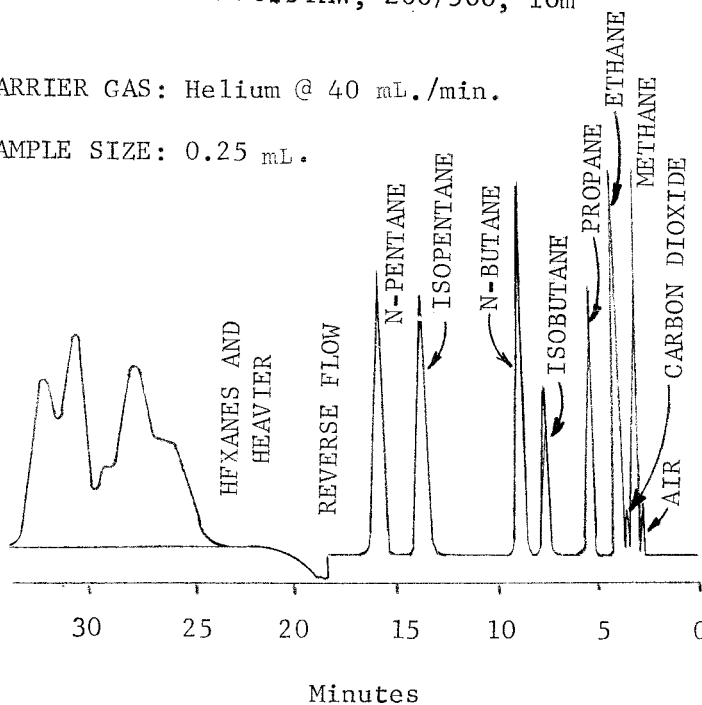

FIG. 5 Chromatogram of Natural Gas (Silicone 200/500 Column) (See Annex A2)

loop with up to two atmospheres of sample pressure, thus extending the range of all components. The well type inherently offers better precision and is preferred when calibrating with pure components. Samples with up to one atmosphere of pressure can be entered. With either type manometer the mm scale can be read more accurately than the inch scale. Caution should be used handling mercury because of its toxic nature. Avoid contact with the skin as much as possible. Wash thoroughly after contact.

5.12 *Vacuum Pump*—Must have the capability of producing a vacuum of 1 mm of mercury absolute or less.

6. Preparation of Apparatus

6.1 *Linearity Check*—To establish linearity of response for the thermal conductivity detector, it is necessary to complete the following procedure:

6.1.1 The major component of interest (methane for natural gas) is charged to the chromatograph by way of the fixed-size

ASTM D 1945

COLUMN: DIDP-3meter +DMS-6meter
@ 35°C.

CARRIER GAS: Helium @ 75 mL./min.

SAMPLE SIZE: 0.5 mL.

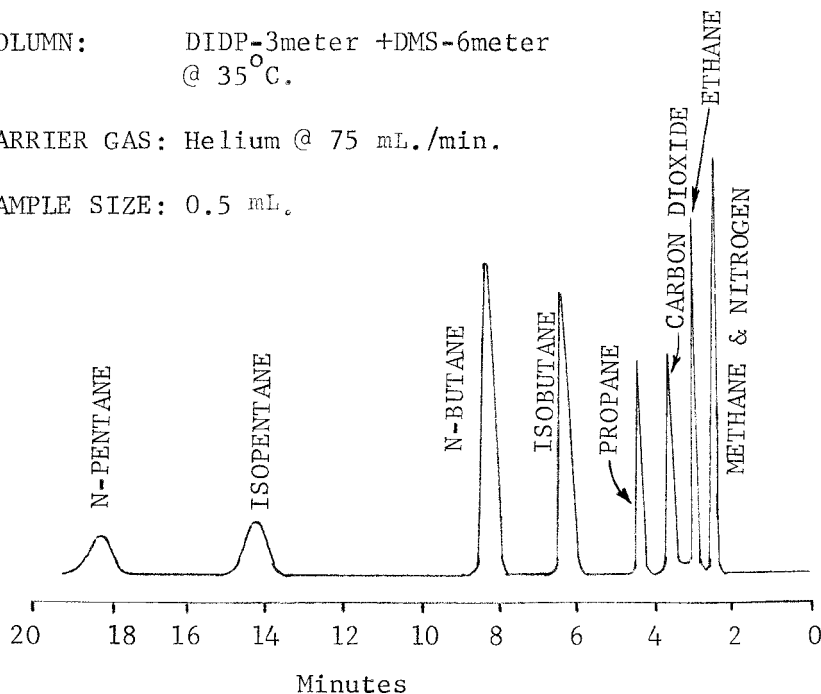

FIG. 6 Chromatogram of Natural Gas (See Annex A2)

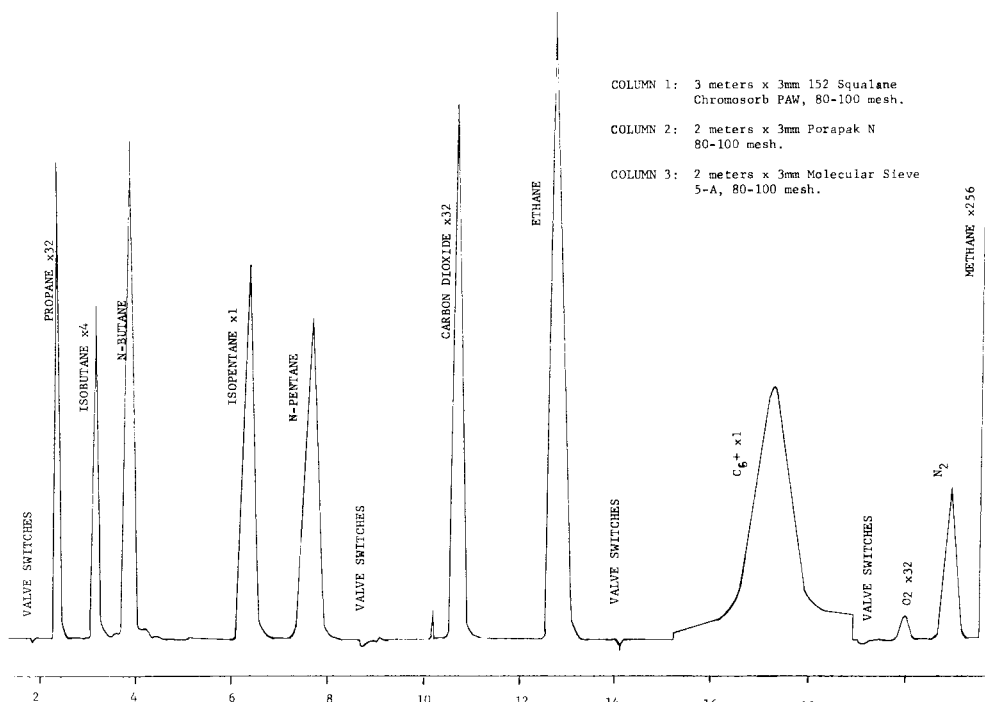

FIG. 7 Chromatogram of Natural Gas (Multi-Column Application) (See Annex A2)

sample loop at partial pressure increments of 13 kPa (100 mm Hg) from 13 to 100 kPa (100 to 760 mm Hg) or the prevailing atmospheric pressure.

6.1.2 The integrated peak responses for the area generated at each of the pressure increments are plotted versus their partial pressure (see Fig. 9).

6.1.3 The plotted results should yield a straight line. A perfectly linear response would display a straight line at a 45° angle using the logarithmic values.

6.1.4 Any curved line indicates the fixed volume sample loop is too large. A smaller loop size should replace the fixed volume loop and 6.1.1 through 6.1.4 should be repeated (see Fig. 9).

6.1.5 The linearity over the range of interest must be known for each component. It is useful to construct a table noting the response factor deviation in changing concentration. (See Table 2 and Table 3).

6.1.6 It should be noted that nitrogen, methane, and ethane

ASTM D 1945

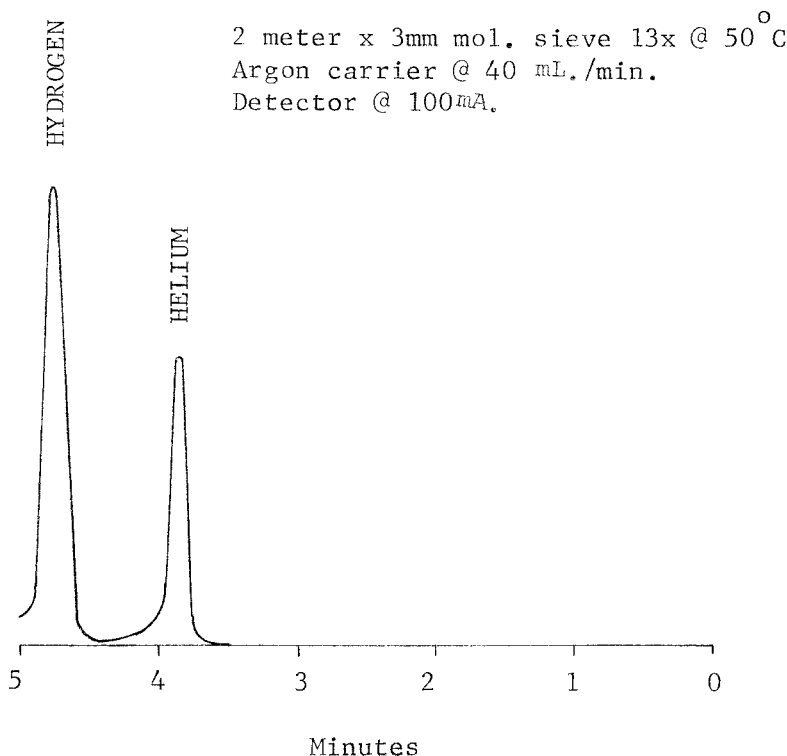

FIG. 8 Separation of Helium and Hydrogen

exhibit less than 1 % compressibility at atmospheric pressure. Other natural gas components do exhibit a significant compressibility at pressures less than atmospheric.

6.1.7 Most components that have vapor pressures of less than 100 kPa (15 psia) cannot be used as a pure gas for a linearity study because they will not exhibit sufficient vapor pressure for a manometer reading to 100 kPa (760 mm Hg). For these components, a mixture with nitrogen or methane can be used to establish a partial pressure that can extend the total pressure to 100 kPa (760 mm Hg). Using Table 4 for vapor pressures at 38°C (100°F), calculate the maximum pressure to which a given component can be blended with nitrogen as follows:

$$B = (100 \times V)/i \quad (2)$$

$$P = (i \times M)/100 \quad (3)$$

where:

B = blend pressure, max, kPa (mm Hg);

V = vapor pressure, kPa (mm Hg);

i = mol %;

P = partial pressure, kPa (mm Hg); and

M = manometer pressure, kPa (mm Hg).

6.2 . Procedure for Linearity Check:

6.2.1 Connect the pure-component source to the sample-entry system. Evacuate the sample-entry system and observe the manometer for leaks. (See Fig. 1 for a suggested manifold arrangement.) The sample-entry system must be vacuum tight.

6.2.2 Carefully open the needle valve to admit the pure component up to 13 kPa (100 mm Hg) of partial pressure.

6.2.3 Record the exact partial pressure and actuate the sample valve to place the sample onto the column. Record the peak area of the pure component.

6.2.4 Repeat 6.2.3 for 26, 39, 52, 65, 78, and 91 kPa (200, 300, 400, 500, 600, and 700 mm Hg) on the manometer, recording the peak area obtained for sample analysis at each of these pressures.

6.2.5 Plot the area data (x axis) versus the partial pressures (y axis) on a linear graph as shown in Fig. 9.

6.2.6 An alternative method is to obtain a blend of all the components and charge the sample loop at partial pressure over the range of interest. If a gas blender is available, the mixture can be diluted with methane thereby giving response curves for all the components. (**Warning**—If it is not possible to obtain information on the linearity of the available gas chromatograph detector for all of the test gas components, then as a minimum requirement the linearity data must be obtained for any gas component that exceeds a concentration of 5 mol%. Chromatographs are not truly linear over wide concentration ranges and linearity should be established over the range of interest.)

7. Reference Standards

7.1 Moisture-free gas mixtures of known composition are required for comparison with the test sample. They must contain known percents of the components, except oxygen (Note 5), that are to be determined in the unknown sample. All components in the reference standard must be homogenous in the vapor state at the time of use. The concentration of a component in the reference standard gas should not be less than one half nor more than twice the concentration of the corresponding component in the test gas.

NOTE 5—Unless the reference standard is stored in a container that has been tested and proved for inertness to oxygen, it is preferable to calibrate for oxygen by an alternative method.

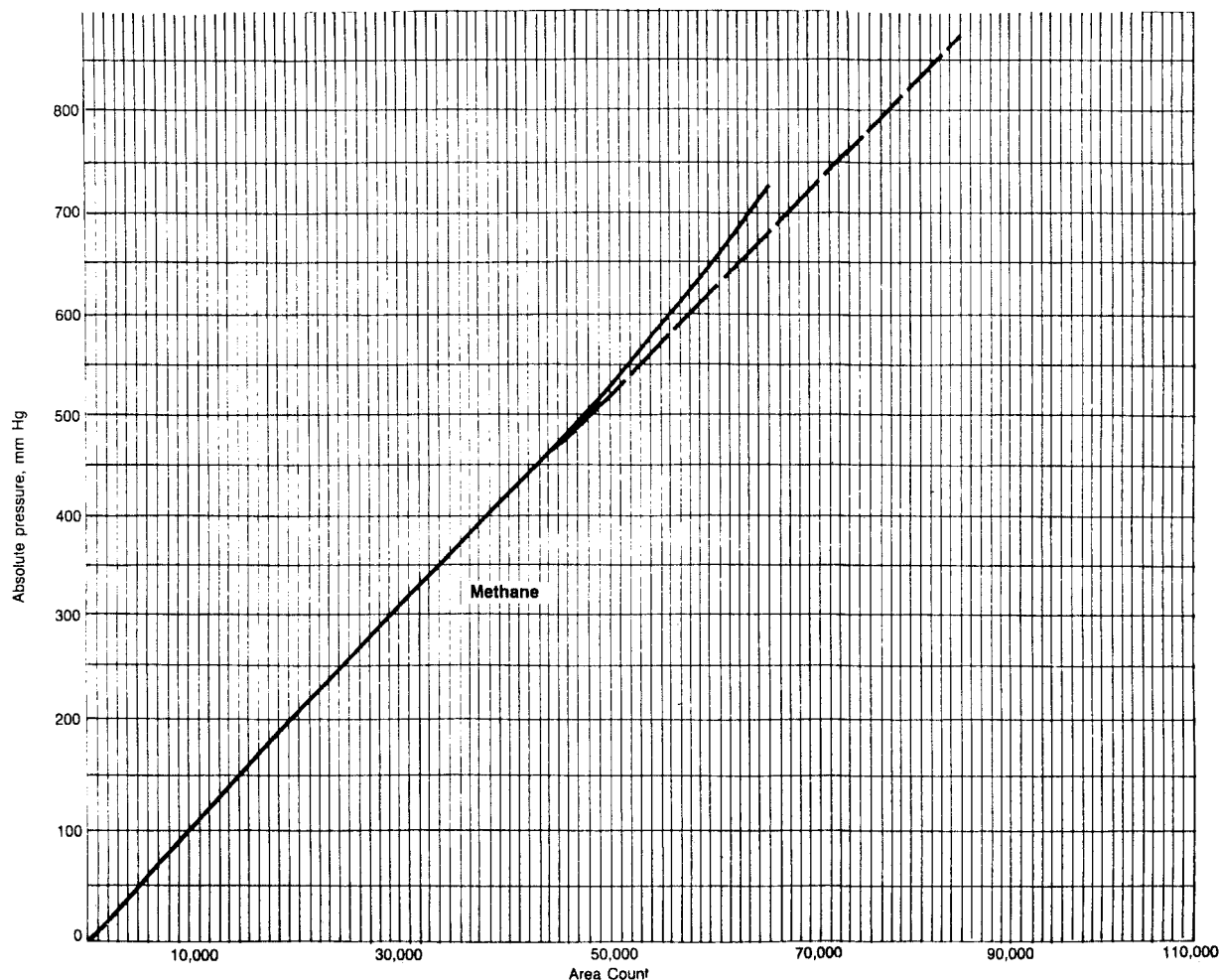

FIG. 9 Linearity of Detector Response

TABLE 2 Linearity Evaluation of Methane

S/B diff = (low mole % - high mole %)/low mole % × 100			
B area	S mole %	S/B mole %/area	S/B diff., % on low value
223 119 392	51	2.2858e-07	
242 610 272	56	2.3082e-07	-0.98
261 785 320	61	2.3302e-07	-0.95
280 494 912	66	2.3530e-07	-0.98
299 145 504	71	2.3734e-07	-0.87
317 987 328	76	2.3900e-07	-0.70
336 489 056	81	2.4072e-07	-0.72
351 120 721	85	2.4208e-07	-0.57

TABLE 3 Linearity Evaluation for Nitrogen

S/B diff = (low mole % - high mole %)/low mole % × 100			
B area	S mole %	S/B mole %/area	S/B diff., % on low value
5 879 836	1	1.7007e-07	
29 137 066	5	1.7160e-07	-0.89
57 452 364	10	1.7046e-07	-1.43
84 953 192	15	1.7657e-07	-1.44
111 491 232	20	1.7939e-07	-1.60
137 268 784	25	1.8212e-07	-1.53
162 852 288	30	1.8422e-07	-1.15
187 232 496	35	1.8693e-07	-1.48

7.2 *Preparation*—A reference standard may be prepared by blending pure components. Diluted dry air is a suitable standard for oxygen and nitrogen (see 8.5.1).^{5,6}

8. Procedure

8.1 *Instrument Preparation*—Place the proper column(s) in operation as needed for the desired run (as described in either

8.4, 8.5, or 8.6). Adjust the operating conditions and allow the chromatograph to stabilize.

8.1.1 For hexanes and higher, heat the sample loop.

NOTE 6—Most modern chromatographs have valve ovens that can be temperature controlled. It is strongly recommended in the absence of valve ovens to mount the gas sampling valve in the chromatograph oven and operate at the column temperature.

8.1.2 After the instrument has apparently stabilized, make check runs on the reference standard to establish instrument repeatability. Two consecutive checks must agree within 1 % of the amount present of each component. Either the average of the two consecutive checks, or the latest check agreeing within

⁵ A suitable reference standard is available from Scott Specialty Gases Inc., Plumsteadville, PA.

⁶ A ten-component reference standard traceable to the National Institute of Standards and Technology (NIST) is available from Institute of Gas Technology (IGT), 3424 S. State St., Chicago, IL 60616.

TABLE 4 Vapor Pressure at 38°C (100°F)^A

Component	kPa absolute	psia
Nitrogen	>34 500	>5000
Methane	>34 500	>5000
Carbon dioxide	>5 520	>800
Ethane	>5 520	>800
Hydrogen sulfide	2 720	395
Propane	1 300	189
Isobutane	501	72.6
<i>n</i> -Butane	356	51.7
Isopentane	141	20.5
<i>n</i> -Pentane	108	15.6
<i>n</i> -Hexane	34.2	4.96
<i>n</i> -Heptane	11.2	1.62

^AThe most recent data for the vapor pressures listed are available from the Thermodynamics Research Center, Texas A&M University System, College Station, TX 77843.

1 % of the previous check on each component may be used as the reference standard for all subsequent runs until there is a change in instrument operating conditions. Daily calibrations are recommended.

8.2 Sample Preparation—If desired, hydrogen sulfide may be removed by at least two methods (see Annex A2.3A2.3).

8.2.1 Preparation and Introduction of Sample—Samples must be equilibrated in the laboratory at 20 to 50°F above the source temperature of the field sampling. The higher the temperature the shorter the equilibration time (approximately 2 h for small sample containers of 300 mL or less). This analysis method assumes field sampling methods have removed entrained liquids. If the hydrocarbon dewpoint of the sample is known to be lower than the lowest temperature to which the sample has been exposed, it is not necessary to heat the sample.

8.2.2 Connections from the sample container to the sample inlet of the instrument should be made with stainless steel or with short pieces of TFE-fluorocarbon. Copper, vinyl, or rubber connections are not acceptable. Heated lines may be necessary for high hydrocarbon content samples.

8.3 Sample Introduction—The size of the sample introduced to the chromatographic columns shall not exceed 0.5 mL. (This small sample size is necessary to obtain a linear detector response for methane.) Sufficient accuracy can be obtained for the determination of all but the minor constituents by the use of this sample size. When increased response is required for the determination of components present in concentrations not exceeding 5 mol %, it is permissible to use sample and reference standard volumes not exceeding 5 mL. (Avoid introduction of liquids into the sample system.)

8.3.1 Purging Method—Open the outlet valve of the sample cylinder and purge the sample through the inlet system and sample loop or tube. The amount of purging required must be established and verified for each instrument. The sample loop pressure should be near atmospheric. Close the cylinder valve and allow the pressure of the sample in the loop or tube to stabilize. Then immediately inject the contents of the loop or tube into the chromatographic column to avoid infiltration of contaminants.

8.3.2 Water Displacement—If the sample was obtained by water displacement, then water displacement may be used to purge and fill the sample loop or tube. (**Warning**—Some components, such as carbon dioxide, hydrogen sulfide, and hexanes and higher hydrocarbons, may be partially or com-

pletely removed by the water.)

8.3.3 Evacuation Method—Evacuate the charging system, including the sample loop, and the sample line back to the valve on the sample cylinder, to less than 0.1 kPa (1 mm Hg) absolute pressure. Close the valve to the vacuum source and carefully meter the fuel-gas sample from the sample cylinder until the sample loop is filled to the desired pressure, as indicated on the manometer (see Fig. 1). Inject the sample into the chromatograph.

8.4 Partition Column Run for Ethane and Heavier Hydrocarbons and Carbon Dioxide—This run is made using either helium or hydrogen as the carrier gas; if other than a thermal conductivity detector is used, select a suitable carrier gas for that detector. Select a sample size in accordance with 8.1. Enter the sample, and backflush heavy components when appropriate. Obtain a corresponding response on the reference standard.

8.4.1 Methane may also be determined on this column if the column will separate the methane from nitrogen and oxygen (such as with silicone 200/500 as shown in Fig. 5), and the sample size does not exceed 0.5 mL.

8.5 Adsorption Column Run for Oxygen, Nitrogen, and Methane—Make this run using helium or hydrogen as the carrier gas. The sample size must not exceed 0.5 mL for the determination of methane. Enter the sample and obtain a response through methane (Note 5). Likewise, obtain a response on the reference standard for nitrogen and methane. Obtain a response on dry air for nitrogen and oxygen, if desired. The air must be either entered at an accurately measured reduced pressure, or from a helium-diluted mixture.

8.5.1 A mixture containing approximately 1 % of oxygen can be prepared by pressurizing a container of dry air at atmospheric pressure to 2 MPa (20 atm) with pure helium. This pressure need not be measured precisely, as the concentration of nitrogen in the mixture thus prepared must be determined by comparison to nitrogen in the reference standard. The percent nitrogen is multiplied by 0.268 to obtain the mole percent of oxygen or by 0.280 to obtain the mole percent total of oxygen and argon. Do not rely on oxygen standards that have been prepared for more than a few days. It is permissible to use a response factor for oxygen that is relative to a stable constituent.

8.6 Adsorption Column Run for Helium and Hydrogen—Make this run using either nitrogen or argon as the carrier gas. Enter a 1- to 5-mL sample and record the response for helium, followed by hydrogen, which will be just ahead of oxygen (Note 5). Obtain a corresponding response on a reference standard containing suitable concentrations of helium and hydrogen (see Fig. 8).

9. Calculation

9.1 The number of significant digits retained for the quantitative value of each component shall be such that accuracy is neither sacrificed or exaggerated. The expressed numerical value of any component in the sample should not be presumed to be more accurate than the corresponding certified value of that component in the calibration standard.

9.2 External Standard Method:

9.2.1 Pentanes and Lighter Components—Measure the height of each component peak for pentanes and lighter,

D 1945

convert to the same attenuation for corresponding components in the sample and reference standard, and calculate the concentration of each component in the sample as follows:

$$C = S \times (A/B) \quad (4)$$

where:

- C = component concentration in the sample, mol %;
- A = peak height of component in the sample, mm;
- B = peak height of component in the standard, mm; and
- S = component concentration in the reference standard, mol %.

9.2.1.1 If air has been run at reduced pressure for oxygen or nitrogen calibration, or both, correct the equation for pressure as follows:

$$C = S \times (A/B) \times (P_d/P_b) \quad (5)$$

where:

- P_a = pressure at which air is run and
- P_b = true barometric pressure during the run, with both pressures being expressed in the same units.

9.2.1.2 Use composition values of 78.1 % nitrogen and 21.9 % oxygen for dry air, because argon elutes with oxygen on a molecular sieves column under the normal conditions of this test method.

9.2.2 *Hexanes and Heavier Components*—Measure the areas of the hexanes portion and the heptanes and heavier portion of the reverse-flow peak (see Annex A1, Fig. A1.1, and X3.6). Also measure the areas of both pentane peaks on the sample chromatogram, and adjust all measured areas to the same attenuation basis.

9.2.3 Calculate corrected areas of the reverse flow peaks as follows:

$$\text{Corrected } C_6 \text{ area} = 72/86 \times \text{measured } C_6 \text{ area} \quad (6)$$

$$\begin{aligned} &\text{Corrected } C_7 \text{ and heavier area} \\ &= 72/A \times \text{measured } C_7 \text{ and heavier area} \end{aligned} \quad (7)$$

where A = average molecular weight of the C_7 and heavier fraction.

NOTE 7—The value of 98 is usually sufficiently accurate for use as the C_7 and heavier fraction average molecular weight; the small amount of C_8 and heavier present is usually offset by the lighter methyl cyclopentane and cyclohexane that occur in this fraction. A more accurate value for the molecular weight of C_7 and heavier can be obtained as described in Annex A1.3.

9.2.4 Calculate the concentration of the two fractions in the sample as follows:

$$\begin{aligned} &\text{Mol \% } C_6 = (\text{corrected } C_6 \text{ area}) \\ &\times (\text{mol \% } iC_5 + nC_5) / (iC_5 + nC_5 \text{ area}). \end{aligned} \quad (8)$$

$$\begin{aligned} &\text{Mol \% } C_7 + = (\text{corrected } C_7 \text{ area}) \\ &\times (\text{mol \% } iC_5 + nC_5) / (iC_5 + nC_5 \text{ area}). \end{aligned} \quad (9)$$

9.2.4.1 If the mole percent of $iC_5 + nC_5$ has been determined by a separate run with a smaller sized sample, this value need not be redetermined.

9.2.5 The entire reverse flow area may be calculated in this manner as C_6 and heavier, or as C_5 and heavier should the carrier gas reversal be made after n -butane. The measured area should be corrected by using the average molecular weights of the entire reverse-flow components for the value of A . The mole percent and area of the iC_5 and nC_5 reverse flow peak of an identically sized sample of reference standard (free of C_6 and heavier) shall then be used for calculating the final mole percent value.

9.2.6 Normalize the mole percent values by multiplying each value by 100 and dividing by the sum of the original values. The sum of the original values should not differ from 100.0 % by more than 1.0 %.

9.2.7 See sample calculations in Appendix X2.

10. Precision

10.1 *Precision*—The precision of this test method, as determined by the statistical examination of the interlaboratory test results, for gas samples of pipeline quality 38 MJ/m³ (1000 Btu/SCF) is as follows:

10.1.1 *Repeatability*—The difference between two successive results obtained by the same operator with the same apparatus under constant operating conditions on identical test materials should be considered suspect if they differ by more than the following amounts:

Component, mol %	Repeatability
0 to 0.1	0.01
0.1 to 1.0	0.04
1.0 to 5.0	0.07
5.0 to 10	0.08
Over 10	0.10

10.1.2 *Reproducibility*—The difference between two results obtained by different operators in different laboratories on identical test materials should be considered suspect if they differ by more than the following amounts:

Component, mol %	Reproducibility
0 to 0.1	0.02
0.1 to 1.0	0.07
1.0 to 5.0	0.10
5.0 to 10	0.12
Over 10	0.15

11. Keywords

11.1 gas analysis; gas chromatography; natural gas composition



D 1945

ANNEXES

(Mandatory Information)

A1. SUPPLEMENTARY PROCEDURES

A1.1 Analysis for Only Propane and Heavier Components

A1.1.1 This determination can be made in 10- to 15-min run time by using column conditions to separate propane, isobutane, *n*-butane, isopentane, *n*-pentane, hexanes, and heptanes, and heavier, but disregarding separation on ethane and lighter.

A1.1.2 Use a 5-m bis-(2(2-methoxyethoxy) ethyl)ether (BMEE) column at about 30°C, or a suitable length of another partition column that will separate propane through *n*-pentane in about 5 min. Enter a 1- to 5-mL sample into the column and reverse the carrier gas flow after *n*-pentane is separated. Obtain a corresponding chromatogram on the reference standard, which can be accomplished in about 5-min run time, as there is no need to reverse the flow on the reference standard. Make calculations in the same manner as for the complete analysis method.

A1.1.3 A determination of propane, isobutane, *n*-butane, and pentanes and heavier can be made in about 5-min run time by reversing the carrier-gas flow after *n*-butane. However, it is necessary to know the average molecular weight of the pentanes and heavier components.

A1.2 Single-Run Analysis for Ethane and Heavier Components

A1.2.1 In many cases, a single partition run using a sample size in the order of 1 to 5 mL will be adequate for determining all components except methane, which cannot be determined accurately using this size sample with peak height measurements, because of its high concentration.

A1.2.2 Enter a 1- to 5-mL sample into the partition column and reverse the carrier gas flow after *n*-pentane is separated. Obtain a corresponding chromatogram of the reference standard. Measure the peak heights of ethane through *n*-pentane and the areas of the pentane peaks of the standard. Make calculations on ethane and heavier components in the same manner as for the complete analysis method. Methane and lighter may be expressed as the difference between 100 and the sum of the determined components.

A1.3 Special Analysis to Determine Hexanes and Heavier Components

A1.3.1 A short partition column can be used advantageously to separate heavy-end components and obtain a more detailed breakdown on composition of the reverse-flow fractions. This information provides quality data and a basis for calculating physical properties such as molecular weight on these fractions.

A1.3.2 Fig. A1.1 is a chromatogram that shows components that are separated by a 2-m BMEE column in 20 min. To make this determination, enter a 5-mL sample into the short column and reverse the carrier gas after the separation of *n*-heptane. Measure areas of all peaks eluted after *n*-pentane. Correct each peak area to the mol basis by dividing each peak area by the molecular weight of the component. A value of 120 may be used for the molecular weight of the octanes and heavier reverse-flow peak. Calculate the mole percent of the hexanes and heavier components by adding the corrected areas and dividing to make the total 100 %.

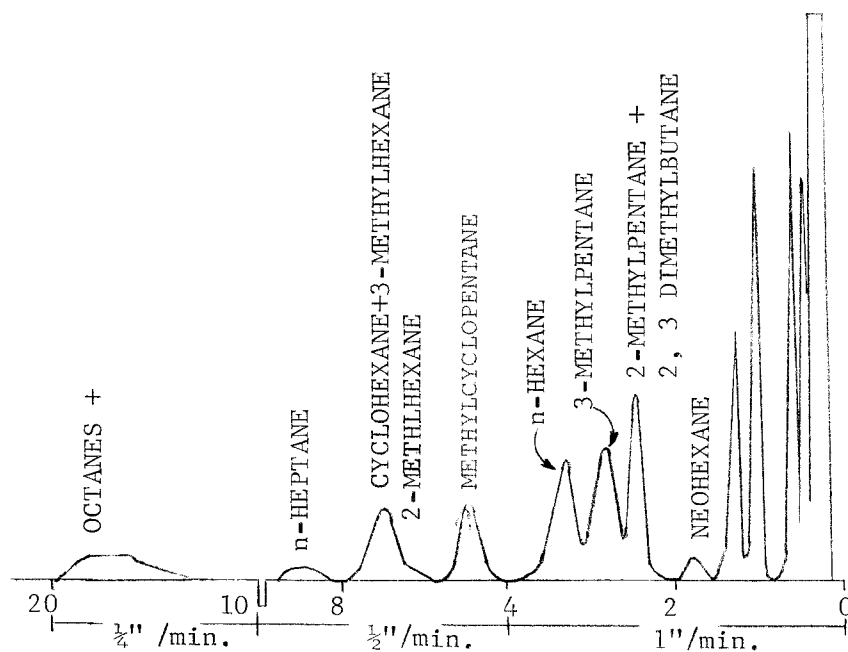

FIG. A1.1 Composition of Hexanes and Heavier Fraction

A2. PREPARATION OF COLUMNS AND DRIER

A2.1 *Preparation of Columns*—See Practice E 260.

A2.2 *Preparation of Drier*—Fill a 10-mm diameter by 100-mm length glass tube with granular phosphorus pentoxide or magnesium perchlorate, observing all proper safety precautions. Mount as required to dry the sample. Replace the drying agent after about one half of the material has become spent.

A2.3 *Removal of Hydrogen Sulfide:*

A2.3.1 For samples containing more than about 300 ppm by mass hydrogen sulfide, remove the hydrogen sulfide by connecting a tube of sodium hydrate absorbent (Ascarite) ahead of the sample container during sampling, or ahead of the drying tube when entering the sample into the chromatograph. This procedure also removes carbon dioxide, and the results obtained will be on the acid-gas free basis.

A2.3.2 Hydrogen sulfide may also be removed by connecting a tube of pumice that has been impregnated with cupric

sulfate in the line upstream of both the chromatograph and drying tube. This procedure will remove small amounts of hydrogen sulfide while having but minimal effect on the carbon dioxide in the sample.

A2.4 *Column Arrangement*—For analyses in which hexanes and heavier components are to be determined, Fig. A2.1 shows an arrangement whereby columns can be quickly and easily changed by the turn of a selector valve. Two columns are necessary to determine all of the components covered in this test method. However, short and long partition columns provide the flexibility of three partition column lengths, by using them either singly or in series. The connection between V_1 and V_2 in Fig. A2.1 should be as short as possible (20 mm is practical) to minimize dead space between the columns when used in series. If all columns are chosen to operate at the same temperature, then stabilization time between changing columns will be minimized.

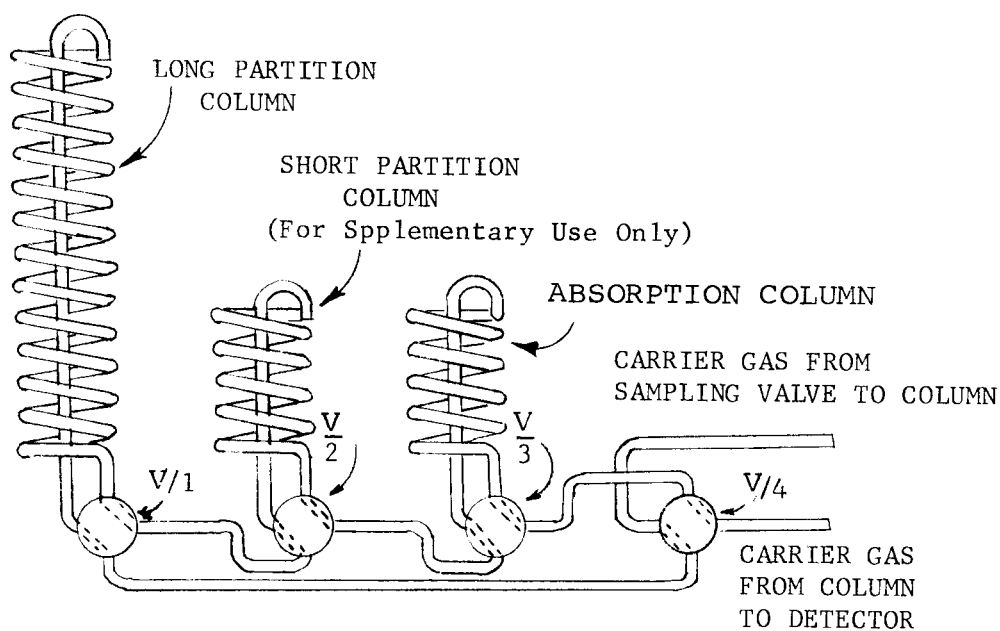

FIG. A2.1 Column Arrangement



APPENDIXES

(Nonmandatory Information)

X1. REFERENCE STANDARD MIXTURE

X1.1 Preparation

X1.1.1 Gas mixtures of the following typical compositions will suffice for use as reference standards for most analytical requirements (Note X1.1):

Component	Lean Gas, mol %	Rich Gas, mol %
Helium	1.0	0.5
Hydrogen	3.0	0.5
Nitrogen	4.0	0.5
Methane (maximum)	85	74
Ethane	6.0	10
Carbon dioxide	1.0	1.0
Propane	4.0	7.0
Isobutane	2.0	3.0
<i>n</i> -Butane	2.0	3.0
Neopentane	0.5	1.0
Isopentane	0.5	1.0
<i>n</i> -Pentane	0.5	1.0
Hexanes+	0.1	0.2

NOTE X1.1—If the mixture is stored under pressure, take care to ensure that the partial pressure of any component does not exceed its vapor pressure at the temperature and pressure at which the sample is stored and used. The lean mixture has a cricondentherm at 60°F and the rich mixture has a cricondentherm at 100°F.

X1.1.2 A useful method for preparation of a reference standard by weight is as follows:⁵

X1.1.2.1 Obtain the following equipment and material:

Cylinder, 20 L

Pressure Cylinders, two 100 mL (A and B)

Balance, 2000-g capacity, sensitivity of 10 mg.

Pure Components, methane through *n*-pentane, and carbon dioxide. The pure components should be 99+ % pure. Methane should be in a 1-L cylinder at 10-MPa (100-atm) pressure. Run a chromatogram of each component to check on its given composition.

X1.1.2.2 Evacuate the 20-L cylinder for several hours. Evacuate 100-mL Cylinder A, and obtain its true weight. Connect Cylinder A to a cylinder of pure *n*-pentane with a metal connection of calculated length to contain approximately the amount of *n*-pentane to be added. Flush the connection with the *n*-pentane by loosening the fitting at the valve on Cylinder A. Tighten the fitting. Close the *n*-pentane cylinder valve and open Cylinder A valve to admit the *n*-pentane from the connection and then close the valve on Cylinder A. Disconnect and weigh Cylinder A to obtain the weight of *n*-pentane added.

X1.1.2.3 Similarly, add isopentane, *n*-butane, isobutane, propane, ethane, and carbon dioxide, in that order, as desired, in the reference standard. Weigh Cylinder A after each addition to obtain the weight of the component added. Connect Cylinder A to the evacuated 20-L cylinder with as short a clean, small-diameter connector as possible. Open the valve on the 20-L cylinder, then open the valve on Cylinder A. This will result in the transfer of nearly all of the contents of Cylinder A into the 20-L cylinder. Close the cylinder valves, disconnect, and weigh Cylinder A to determine the weight of mixture that

was not transferred to the 20-L cylinder.

X1.1.2.4 Evacuate and weigh 100-mL Cylinder B. Then fill Cylinder B with helium and hydrogen respectively to the pressures required to provide the desired concentrations of these components in the final blend. (Helium and hydrogen are prepared and measured separately from the other components to prevent their pressures, while in the 100-mL cylinder, from causing condensation of the higher hydrocarbons.) Weigh Cylinder B after each addition to obtain the weight of the component added. Connect Cylinder B to the 20-L cylinder with as short a clean, small-diameter connector as possible. Open the valve on the 20-L cylinder, then open the valve on Cylinder B, which will result in the transfer of nearly all of the contents of Cylinder B into the 20-L cylinder. Close the cylinder valves, disconnect, and weigh Cylinder B to obtain the weight of the mixture that was not transferred to the 20-L cylinder.

X1.1.2.5 Weigh a 1-L cylinder containing pure methane at about 10-MPa (100-atm) pressure. Transfer the methane to the 20-L cylinder until the pressure equalizes. Weigh the 1-L cylinder to determine the weight of methane transferred.

X1.1.2.6 Thoroughly mix the contents of the 20-L cylinder by heating at the bottom by a convenient means such as hot water or a heat lamp, and leaving the cylinder in a vertical position for at least 6 h.

X1.1.2.7 Use the weights and purities of all components added to calculate the weight composition of the mixture. Convert the weight percent to mole percent.

X1.2 Calibration with Pure Components

X1.2.1 Use helium carrier gas to admit a sample volume of 0.25 to 0.5 mL into the adsorption column, providing methane at 50-kPa (375-mm Hg) and nitrogen at 10-kPa (75-mm Hg) absolute pressure. Run a sample of the standard mixture at 70-kPa (525-mm Hg) pressure and obtain peaks for methane and nitrogen.

NOTE X1.2—Each run made throughout this procedure should be repeated to ensure that peak heights are reproducible after correction for pressure differences to within 1 mm or 1 % of the mean value. All peaks should be recorded at an instrument attenuation that gives the maximum measurable peak height.

X1.2.2 Change the carrier gas to argon or nitrogen and, after the base line has stabilized, enter a sample of pure helium at 7-kPa (50-mm Hg) absolute pressure, recording the peak at an attenuation that allows maximum peak height. Run a sample of the mixture at 70-kPa (525-mm Hg) absolute pressure and obtain the helium peak.

X1.2.3 Switch to the partition column with helium carrier gas, and run the gas mixture at 70-kPa (525-mm Hg) absolute pressure. Then admit samples of pure ethane and propane at 10-kPa (75-mm Hg) absolute pressure, and butanes, pentanes, and carbon dioxide at 5-kPa (38-mm Hg) absolute pressure.

 **D 1945**

X1.2.4 Run the gas mixture at 70-kPa (525-mm Hg) absolute pressure.

X1.2.5 Calculate the composition of the prepared gas mixture as follows:

X1.2.5.1 Correct peak heights of all pure components and the respective components in the blend to the same attenuation (Note X1.2).

X1.2.5.2 Calculate the concentration of each component as follows:

$$C = (100V_f)(A/B)(P_b/P_a) \quad (X1.1)$$

where:

- C = component concentration, mol;
- A = peak height of component in blend;
- B = peak height of pure component;
- P_a = pressure at which blend is run, kPa (mm Hg);
- P_b = pressure at which component is run, kPa (mm Hg);
and
- V_f = volume fraction of pure component.

NOTE X1.3— $V_f = 1.000$ if the calibration component is free of impurities.

X1.2.5.3 Normalize values to 100.0 %.

X1.3 Calibration using Relative Molar Response Values

X1.3.1 Relative response ratios can be derived from linearity data and used for calculating response factors. This eliminates the need for a multicomponent standard for daily calibration. The test method can be used on any gas chromatograph using a thermal conductivity or thermistor detector.

X1.3.2 Obtain a blend that brackets the expected concentration the instrument will be analyzing. The major component (methane) is used as the balance gas and may fall below the expected concentration. This component is present in the daily calibration standard and linearity is assured from previous tests.

X1.3.3 Inject the sample at reduced pressures using the apparatus in Fig. 1 or using a mechanical gas blender. Obtain repeatable peak areas or height at 90, 75, 60, 45, 30, and 15 % of absolute pressure. For 100 kPa (760 mm Hg), the pressures used are 90 kPa (684 mm Hg), 75 kPa (570 mm Hg), 60 kPa (456 mm Hg), 45 kPa (342 mm Hg), 30 kPa (228 mm Hg), 15 kPa (114 mm Hg).

X1.3.4 Plot the area or height (attenuated at the same height as the reference component) versus concentration and calculate the slope of the line by the least squares method. Given the equation of the line as $Y = a_0 + a_1 X$ where Y represents the area or height points and X the concentration points. The line is assumed to intersect through the origin and $a_0 = 0$. The slope a_1 can be calculated by:

$$a_1 = \frac{\sum XY}{(\sum Y)^2} \quad (X1.2)$$

X1.3.5 Ratio the slopes of the referenced components (i) to the slopes of the reference components (r) present in the daily calibration standard. This gives the Relative Molar Response factor (RMR_i) for component (i). The reference component must be present in the same instrumental sequence (except Hexanes+) as the referenced components. For instance, propane can be the reference component for the butanes and pentanes if propane is separated on the same column in the same sequence as the butanes and pentanes. Ethane can be the reference component for carbon dioxide if it elutes in the same sequence as carbon dioxide. The hexanes + peak can be referenced to propane or calculated as mentioned in the body of the standard.

X1.3.6 For daily calibration, a four-component standard is used containing nitrogen, methane, ethane, and propane. The fewer components eliminates dew point problems, reactivity, is more accurate and can be blended at a higher pressure. The referenced components' response factors are calculated from the current reference factor and the Relative Molar Response factor. Following is a description of the basic calculations, an example of deriving a Relative Molar Response factor (Fig. X1.1), and a table showing how response factors are calculated (Table X1.2).

$$\text{Response Factor (R)} = \frac{\text{Mole \%}}{\text{Area}}, \quad (X1.3)$$

$$\text{Relative Molar Response (RMR}_i) = \frac{\text{Mole \%}(i)/\text{Area}(i)}{\text{Mole \%}(r)/\text{Area}(r)} \quad (X1.4)$$

$$R_{iC_4} = RMR_{iC_4} \times R_{C_3} \quad (X1.5)$$

X1.3.7 Periodic checks of the RMR relationship is recommended. The relationship is independent of temperature, sample size, and carrier gas flow rate. If changes occur in these operating conditions, all of the components will be affected equally and the calculated response factors will shift accordingly. See Table X1.1 and Fig. X1.1 and Table X1.2.

TABLE X1.1 Least Square Calculation for Slope of Iso-Butane

	Area Y	Mole % X	XY	Y ²
	984 515	1	984 515	9.693e + 11
	900 410	0.9	810 369	8.107e + 11
	758 917	0.75	569 187.75	5.670e + 11
	611 488	0.6	366 892.8	3.739e + 11
	466 037	0.45	209 716.65	2.172e + 11
	314 649	0.3	94 394.7	9.900e + 10
	159 303	0.15	23 895.45	2.538e + 10
sum =	4 195 319	4.15	3 058 971.35	3.071 452e + 12
slope =		$\sum XY/\sum Y^2$	9.9594e-07	

ASTM D 1945

I BUTANE

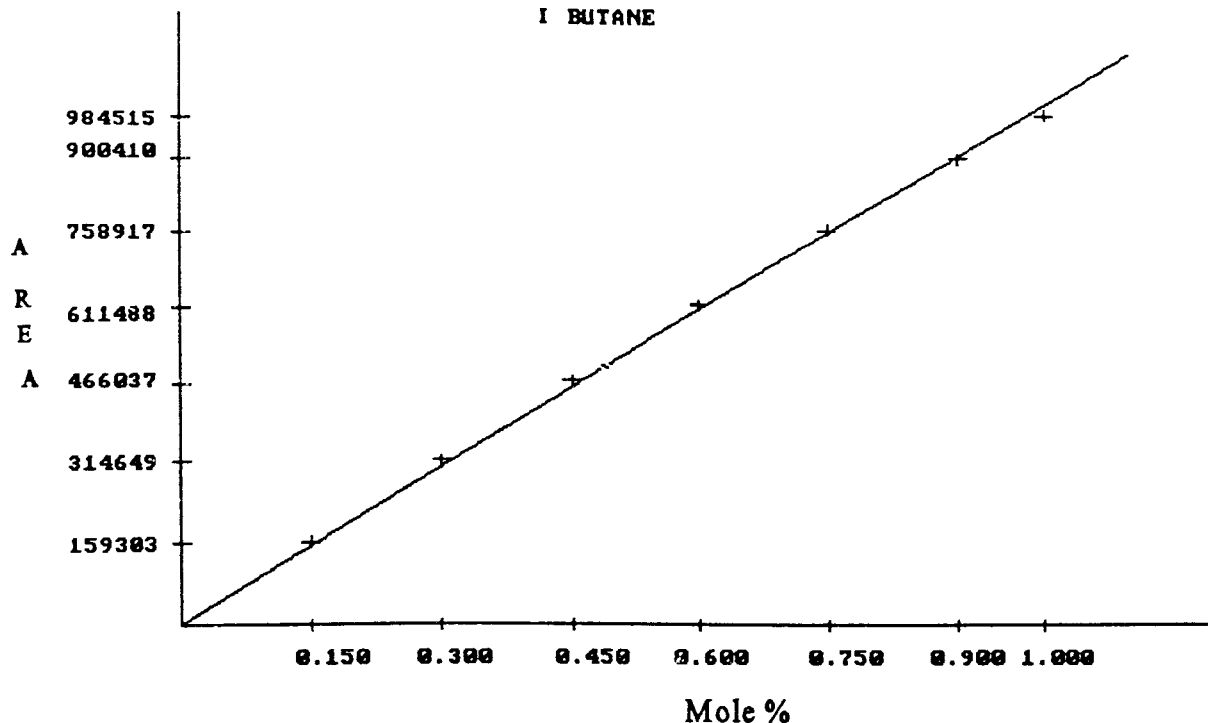

FIG. X1.1 Example of Deriving a Relative Molar Response Factor

TABLE X1.2 Calculation of Response Factors Using Relative Molar Response Values

Component	Mole % in Reference Standard S	Response of Reference Standard B	Response Factor From Reference Standard S/B,K	Relative Molar ^A Response from Slope/ K_i RMR _i	Response Factor of Referenced Components (RMR _i)x(K_i)
Nitrogen	5.08	2 685 885	1.8914E-6		
Methane	82.15	36 642 384	2.2419E-6		
Ethane	8.75	6 328 524	1.3826E-6		
Propane	4.02	3 552 767	1.1315E-6		
Carbon dioxide				1.116 07 _{c2}	1.5429E-6
Isobutane				0.729 58 _{c3}	9.9594E-7
n-Butane				0.693 10 _{c3}	9.1142E-7
Neopentane				0.682 71 _{c3}	8.9776E-7
Isopentane				0.638 74 _{c3}	8.3994E-7
n-Pentane				0.600 41 _{c3}	7.8953E-7
Hexanes+				0.547 62 _{c3}	7.2012E-7

^AThe Relative Molar Response is a constant that is calculated by dividing the slope of the referenced component by the component that is present in the reference standard. For example:

$$RMR_{ic_4} = (\text{slope}_{ic_4}) / (K_{C_3}) = 9.9594E-7 / 1.1315E-6 = 0.729 58$$

X2. SAMPLE CALCULATIONS (SEE SECTION 9)

X3. PRECAUTIONS FOR AVOIDING COMMON CAUSES OF ERRORS

X3.1 Hexane and Heavier Content Change

X3.1.1 The amounts of heavy-end compounds in natural gas are easily changed during handling and entering of samples to give seriously erroneous low or high values. Concentration of these components has been observed to occur in a number of cases because of collection of heavier components in the sample loop during purging of the system. The surface effect of small diameter tubing acts as a separating column and must not be used in the sampling and entering system when components

heavier than pentanes are to be determined. An accumulation of oily film in the sampling system greatly aggravates this problem. Also, the richer the gas, the worse the problem. Periodically, check C₆ and heavier repeatability of the apparatus by making several check runs on the same sample. It is helpful to retain a sample containing some hexanes and heavier for periodic checking. When enlargement of the heavy end peaks is noted, thoroughly clean the sampling valve and loop with acetone. This trouble has been experienced with some



D 1945

TABLE X2.1 Sample Calculations

Component	Mol % in Reference Standard, S	Response of Reference Standard, B	Response Factor, S/B	Response for Sample, ^A A	Percent C = (S × A)/B	Normalized, %
Helium	0.50	41.1	0.0122	12.6	0.154	0.15
Hydrogen	0.74	90.2	0.0082	1.5	0.012	0.01
Oxygen	0.27	35.5	0.0076	2.1	0.016	0.02
Nitrogen	4.89	77.8	0.0629	75.6	4.755	4.75
Methane	70.27	76.4	0.9198	90.4	83.150	83.07
Ethane	9.07	96.5	0.0940	79.0	7.426	7.42
Carbon dioxide	0.98	57.5	0.0170	21.2	0.360	0.36
Propane	6.65	55.2	0.1205	20.6	2.482	2.48
Isobutane	2.88	73.2	0.0393	11.0	0.432	0.43
<i>n</i> -Butane	2.87	60.3	0.0476	15.0	0.714	0.71
Neopentane	0.59	10.4	0.0567	0.1	0.006	0.01
Isopentane	0.87	96.0	0.0091	24.0	0.218	0.22
<i>n</i> -Pentane	0.86	86.8	0.0099	20.5	0.203	0.20
Hexanes+ ^B				72.1 ^C	0.166 ^D	0.17
					100.094 %	100.00 %

^AThe response for a constituent in the sample has been corrected to the same attenuation as for that constituent in the reference standard.

^BAverage molecular weight of C₆ + = 92.

^CCorrected C₆ response = (original response of 92.1) × (72/92) = 72.1.

^DMol % C₆ + = (0.218 + 0.203) × (72.1)/(96.0 + 86.8) = 0.166.

% iC₅ % nC₅ Areas iC + nC₅

inlet systems even when clean and with the specified sample loop size. This contamination can be minimized by such techniques as purging with inert gas, heating the sample loop, using a vacuum system, or other such effective means.

X3.2 Acid Gas Content Change

X3.2.1 The carbon dioxide and hydrogen sulfide contents of gas are easily altered during sampling and handling. If samples containing carbon dioxide or hydrogen sulfide, or both, are to be taken, use completely dry sample cylinders, connections, and lines, as moisture will selectively absorb appreciable amounts of the acid gases. If hydrogen is present, use aluminum, stainless steel, or other materials inert to hydrogen sulfide for the cylinder, valves, lines, and connections.

X3.3 Sample Dew Point

X3.3.1 Nonrepresentative samples frequently occur because of condensation of liquid. Maintain all samples above the hydrocarbon dew point. If cooled below this, heat 10°C or more above the dew point for several hours before using. If the dew point is unknown, heat above the sampling temperature.

X3.4 Sample Inlet System

X3.4.1 Do not use rubber or plastic that may preferentially adsorb sample components. Keep the system short and the drier small to minimize the purging required.

X3.5 Sample Size Repeatability

X3.5.1 Varying back pressures on the sample loop may impair sample size repeatability.

X3.5.2 Make it a practice to make all reverse flow determinations in the same carrier gas flow direction. All single-peak determinations and corresponding reference runs will then be made in the same carrier gas flow direction.

X3.5.3 Be sure that the inlet drier is in good condition. Moisture on the column will enlarge the reverse flow peak.

X3.5.4 Be sure the column is clean by occasionally giving it several hours sweep of carrier gas in reverse flow direction. A

level baseline should be quickly attained in either flow direction if the column is clean.

X3.5.5 When the reverse flow valve is turned, there is a reversal of pressure conditions at the column ends that upsets the carrier gas flow. This flow should quickly return to the same flow rate and the baseline level out. If it does not, the cause may be a leak in the carrier gas system, faulty flow regulator, or an unbalanced condition of the column or plumbing.

X3.6 Reference Standard

X3.6.1 Maintain the reference standard at +15°C or a temperature that is above the hydrocarbon dew point. If the reference standard should be exposed to lower temperatures, heat at the bottom for several hours before removing a sample. If in doubt about the composition, check the *n*-pentane and isopentane values with pure components by the procedure prescribed in Annex A2.

X3.7 Measurements

X3.7.1 The baseline and tops of peaks should be plainly visible for making peak height measurements. Do not use a fixed zero line as the baseline, but use the actual observed baseline. On high sensitivity, this baseline may drift slightly without harm and it need not frequently be moved back to zero. A strip-chart recorder with an offset zero is desirable. The area of reverse flow peak may be measured by planimeter or geometric construction. The reverse flow area, and the pentanes peaks used for comparison, should be measured by the same method. That is, use either geometric construction or planimeter, but do not intermix. When a planimeter is used, carefully make several tracings and use the average. Check this average by a second group of tracings.

X3.8 Miscellaneous

X3.8.1 Moisture in the carrier gas that would cause trouble on the reverse flow may be safeguarded against by installing a cartridge of molecular sieves ahead of the instrument. Usually 1 m of 6-mm tubing packed with 30- to 60-mesh molecular sieves is adequate, if changed with each cylinder of carrier gas.

 **D 1945**

X3.8.2 Check the carrier gas flow system periodically for leaks with soap or leak detector solution.

X3.8.3 Use electrical contact cleaner on the attenuator if noisy contacts are indicated.

X3.8.4 Peaks with square tops with omission of small peaks can be caused by a sluggish recorder. If this condition cannot be remedied by adjustment of the gain, check the electronics in the recorder.

The American Society for Testing and Materials takes no position respecting the validity of any patent rights asserted in connection with any item mentioned in this standard. Users of this standard are expressly advised that determination of the validity of any such patent rights, and the risk of infringement of such rights, are entirely their own responsibility.

This standard is subject to revision at any time by the responsible technical committee and must be reviewed every five years and if not revised, either reapproved or withdrawn. Your comments are invited either for revision of this standard or for additional standards and should be addressed to ASTM Headquarters. Your comments will receive careful consideration at a meeting of the responsible technical committee, which you may attend. If you feel that your comments have not received a fair hearing you should make your views known to the ASTM Committee on Standards, at the address shown below.

This standard is copyrighted by ASTM, 100 Barr Harbor Drive, PO Box C700, West Conshohocken, PA 19428-2959, United States. Individual reprints (single or multiple copies) of this standard may be obtained by contacting ASTM at the above address or at 610-832-9585 (phone), 610-832-9555 (fax), or service@astm.org (e-mail); or through the ASTM website (www.astm.org).