

Window and Door Installation



FEMA



HOME BUILDER'S GUIDE TO COASTAL CONSTRUCTION FEMA 499/August 2005 Technical Fact Sheet No. 22

Purpose: To provide flashing detail concepts for window and door openings that:

- give adequate resistance to water intrusion in coastal environs,
- do not depend solely on sealants,
- are integral with secondary weather barriers (i.e., housewrap or building paper – see Fact Sheet No. 23), and
- are adequately attached to the wall.

Key Issues

Water intrusion around window and door openings can cause dry rot and fastener corrosion that weaken the window or door frame or the wall itself, and lead to water damage to interior finishes, mold growth, and preventable building damage during coastal storms. Proper flashing sequence must be coordinated across responsibilities sometimes divided between two or more trade activities (e.g., weather barrier, window, and siding installation).

To combat wind-driven rain penetration and high wind pressures, window and door frames must be adequately attached to walls and they must be adequately integrated with the wall's moisture barrier system (see Fact Sheet No. 9).

ASTM E 2112

Detailed information about window and door installation is provided in the American Society for Testing and Materials (ASTM) standard ASTM E 2112, a comprehensive installation guide intended for use in training instructors who in turn train the mechanics who actually perform window and door installation. The standard concentrates on detailing and installation procedures that are aimed at minimizing water infiltration.

The standard includes a variety of window and door details. The designer should select the details deemed appropriate and modify them if necessary to meet local weather conditions, and the installer should execute the selected details as specified in the standard or as modified by the designer.

Section 1.5 states that if the manufacturer's instructions conflict with E 2112, the manufacturer's instructions shall prevail. However, because a manufacturer's instructions may be inferior to the guidance provided in the standard, any conflict between the manufacturer's requirements and the standard or contract documents should be discussed among and resolved by the manufacturer, designer, and builder.

Specific Considerations

Pan flashings: Windows that do not have nailing flanges, and doors, are typically installed over a pan flashing (see Figure 1). Section 5.16 of ASTM E 2112 discusses pan flashings and refers to Annex 3 for minimum heights of the end dam and rear leg. Annex 3 shows a maximum end dam height of 2 inches, which is too low for areas prone to very high winds (i.e., wind speed greater than 110 mph). Where the wind speed is greater than 110 mph, the end dam should be 3 - 4 inches high (the higher the wind speed, the higher the dam). (Note: Annex 3 says that "high rain and wind are usually not simultaneous." However, this statement is untrue for coastal storms, in which extremely high amounts of rain often accompany very high winds.)

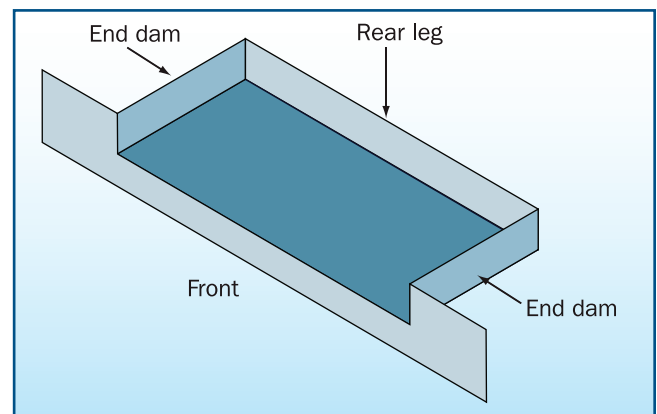

Figure 1 Pan flashing.

Although not discussed in ASTM E 2112, for installations that require an exposed sealant joint, installation of a removable stop (see Figure 2) is recommended to protect the sealant from direct exposure to the weather and reduce the wind-driven rain demand on the sealant.

Exterior Insulation Finishing Systems (EIFS): Although not discussed in ASTM E 2112, when a window or door assembly is installed in an EIFS wall assembly, sealant between the window or door frame and the EIFS should be applied to the EIFS base coat. After sealant application, the top coat is then applied. (The top coat is somewhat porous; if sealant is applied to it, water can migrate between the top and base coats and escape past the sealant.)

Frame anchoring: Window and door frames should be anchored to the wall with the type and number of fasteners specified by the designer.

Shutters: If shutters are installed, they should be anchored to the wall, rather than the window or door frame (see Figure 3).

Weatherstripping: E 2112 does not address door weatherstripping. However, weatherstripping is necessary to avoid wind-driven rain penetration. A variety of weatherstripping products are available as shown in Figures 4 through 9.

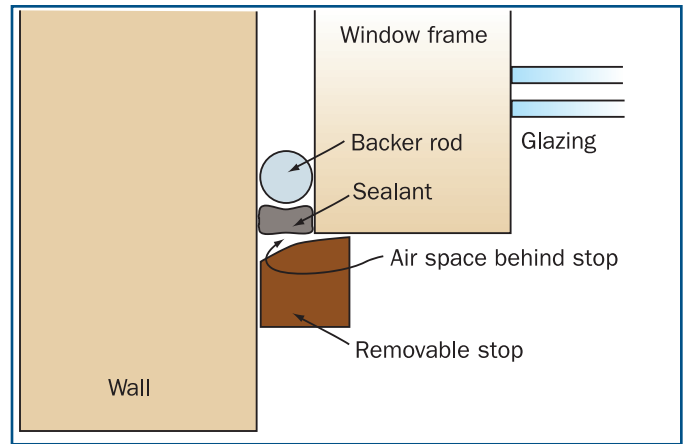

Figure 2
Protection of sealant with a stop.



Figure 3
Hurricane Georges in Puerto Rico. The window lying on the ground was protected by a shutter. However, the shutter was attached to the window frame. The window frame fasteners were over-stressed and the entire assembly failed. Attachment of the shutter directly to the wall framing is a more reliable method of attachment.

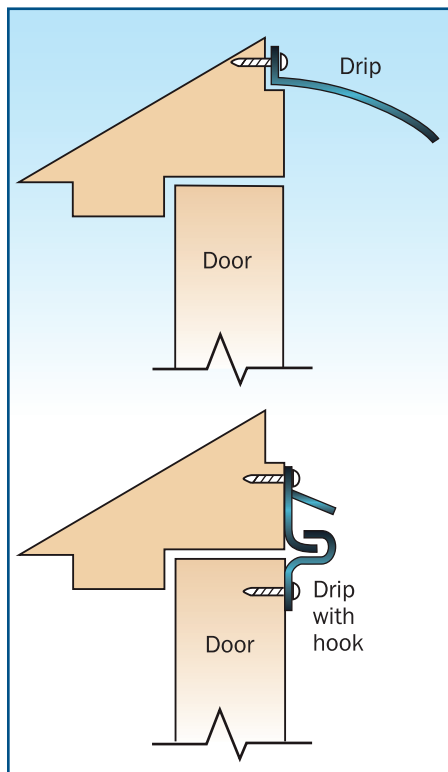

Figure 4
Drip at door head and drip with hook at head

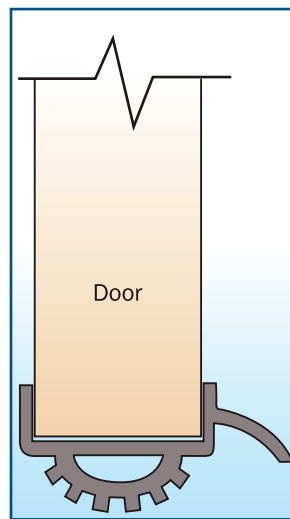

Figure 5
Door shoe with drip and vinyl seal.

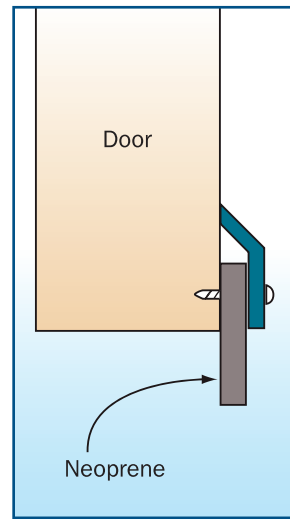

Figure 6
Neoprene door bottom sweep.

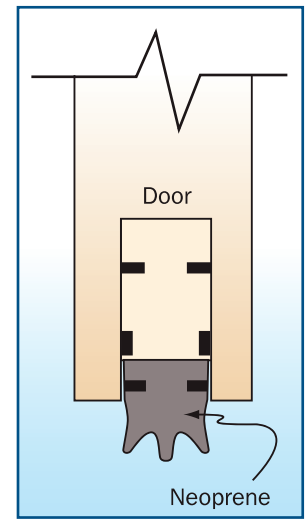

Figure 7
Automatic door bottom.

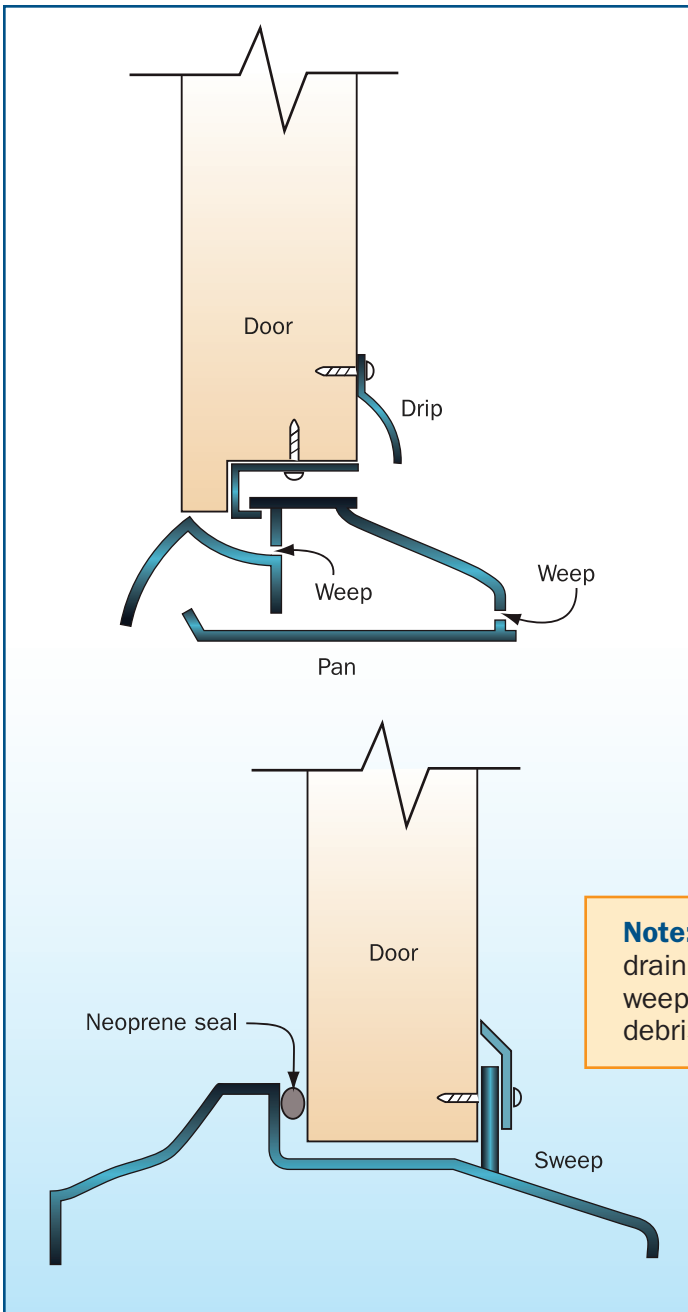

Figure 8 Thresholds.

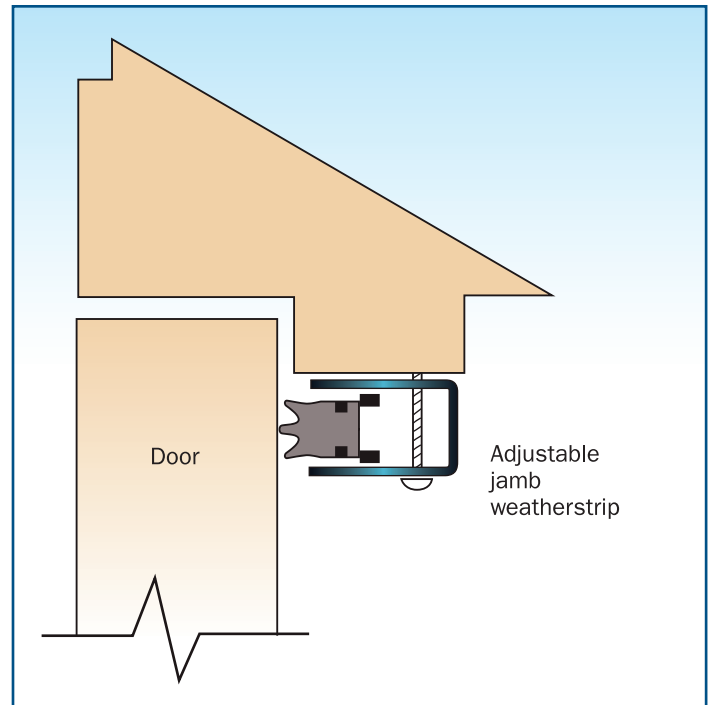

Figure 9 Adjustable jamb/head weatherstripping.

Note: Set the threshold in butyl sealant. If a drain pan exists underneath the threshold, weep holes must not be blocked with sealant or debris.

Additional Resources

American Society for Testing and Materials. ASTM E 2112, *Standard Practice for Installation of Exterior Windows, Doors and Skylights*. (www.astm.org)