

**CUSTOMER
DRIVEN**



**FLEXIBLE
BY DESIGN**

Manufacturer of Commercial - Industrial METAL Roofing & Siding

Cold Formed Structural Sections

Customized to meet your needs

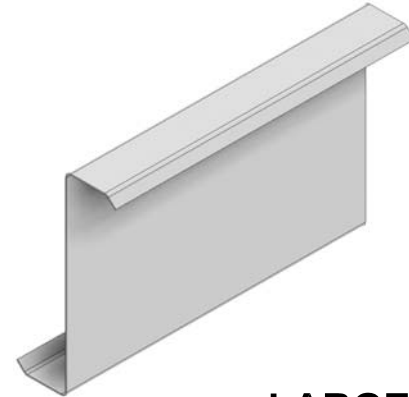

**LARGE
INVENTORY**

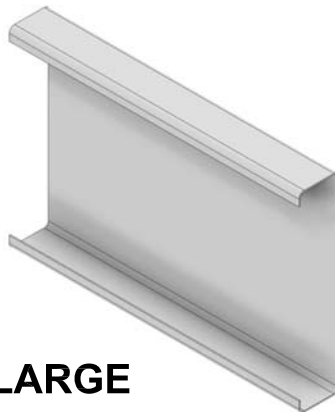

**LARGE
INVENTORY**



**GALVANIZED
STAINLESS STEEL**

ZAM® AND PRIMED PAINTED

**4" TO 14" CEES AND ZEES,
EAVE STRUTS AND CUSTOM SHAPES**

CONTACT FLEXOSPAN FOR YOUR COLD FORMED STRUCTURAL NEEDS

**SEE OUR WEBSITE @ www.flexospan.com
(800) 245-0396 * FAX: (724) 376-3864
253 RAILROAD STREET * BOX 515 * SANDY LAKE, PA 16145**



FLEXOSPAN STANDARD PUNCHING FOR CEE PURLINS AND GIRTS

STANDARD FINISHES : GALVANIZED, STAINLESS AND GRAY OXIDE

4" x 2 1/2" CEE

(AVAILABLE GAUGES - 16, 14, & 12)

(CALL FLEXOSPAN FOR ADDITIONAL PUNCH SIZES AND PUNCH OPTIONS)

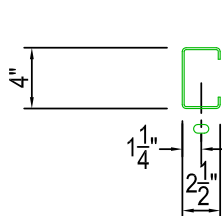

FLANGE PUNCHING
9/16" x 1" SLOTS
(OPTIONAL)

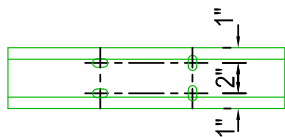

WEB PUNCHING
5/8" x 3/4" SLOTS
(STANDARD)

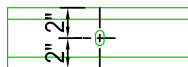

SAG ROD PUNCHING
5/8" x 3/4" SLOTS
(OPTIONAL)

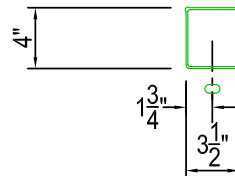

FLANGE PUNCHING
9/16" x 1" SLOTS
(OPTIONAL)

4" x 3 1/2" CEE

(AVAILABLE GAUGES - 16, 14, & 12)

(CALL FLEXOSPAN FOR ADDITIONAL PUNCH SIZES AND PUNCH OPTIONS)

6" x 2 1/2" CEE

(AVAILABLE GAUGES - 16, 14, 12 & 10)

(CALL FLEXOSPAN FOR ADDITIONAL PUNCH SIZES AND PUNCH OPTIONS)

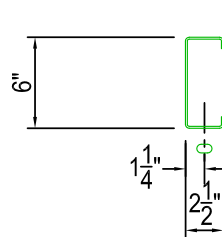

FLANGE PUNCHING
9/16" x 1" SLOTS
(OPTIONAL)

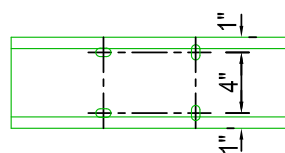

WEB PUNCHING
5/8" x 3/4" SLOTS
(STANDARD)

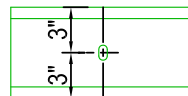

SAG ROD PUNCHING
5/8" x 3/4" SLOTS
(OPTIONAL)

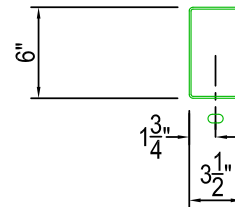

FLANGE PUNCHING
9/16" x 1" SLOTS
(OPTIONAL)

6" x 3 1/2" CEE

(AVAILABLE GAUGES - 16, 14, 12 & 10)

(CALL FLEXOSPAN FOR ADDITIONAL PUNCH SIZES AND PUNCH OPTIONS)

8" x 2 1/2" CEE

(AVAILABLE GAUGES - 16, 14, 12 & 10)

(CALL FLEXOSPAN FOR ADDITIONAL PUNCH SIZES AND PUNCH OPTIONS)

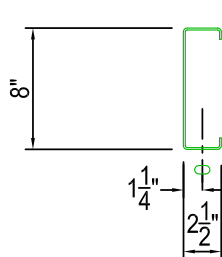

FLANGE PUNCHING
9/16" x 1" SLOTS
(OPTIONAL)

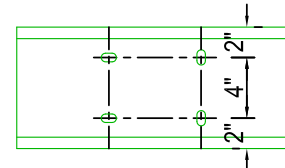

WEB PUNCHING
5/8" x 3/4" SLOTS
(STANDARD)

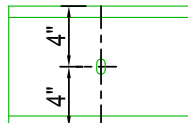

SAG ROD PUNCHING
5/8" x 3/4" SLOTS
(OPTIONAL)

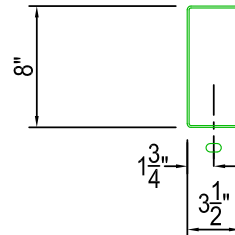

FLANGE PUNCHING
9/16" x 1" SLOTS
(OPTIONAL)

8" x 3 1/2" CEE

(AVAILABLE GAUGES - 16, 14, 12 & 10)

(CALL FLEXOSPAN FOR ADDITIONAL PUNCH SIZES AND PUNCH OPTIONS)

FLEXOSPAN STANDARD PUNCHING FOR CEE PURLINS AND GIRTS

STANDARD FINISHES : GALVANIZED, STAINLESS AND GRAY OXIDE

10" x 2 1/2" CEE

(AVAILABLE GAUGES - 16, 14, 12 & 10)

(CALL FLEXOSPAN FOR ADDITIONAL PUNCH SIZES AND PUNCH OPTIONS)

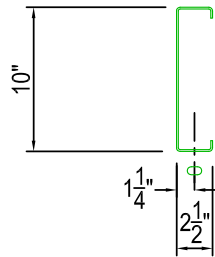

FLANGE PUNCHING
9/16" x 1" SLOTS
(OPTIONAL)

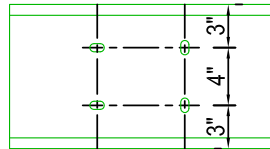

WEB PUNCHING
5/8" x 3/4" SLOTS
(STANDARD)

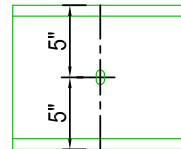

SAG ROD PUNCHING
5/8" x 3/4" SLOTS
(OPTIONAL)

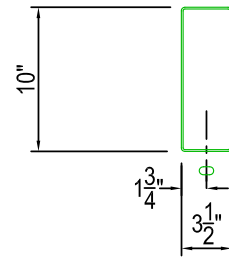

FLANGE PUNCHING
9/16" x 1" SLOTS
(OPTIONAL)

10" x 3 1/2" CEE

(AVAILABLE GAUGES - 14, 12 & 10)

(CALL FLEXOSPAN FOR ADDITIONAL PUNCH SIZES AND PUNCH OPTIONS)

12" x 2 1/2" CEE

(AVAILABLE GAUGES - 14, 12 & 10)

(CALL FLEXOSPAN FOR ADDITIONAL PUNCH SIZES AND PUNCH OPTIONS)

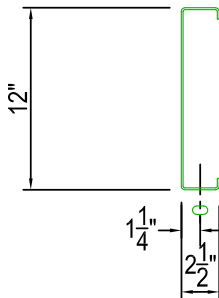

FLANGE PUNCHING
9/16" x 1" SLOTS
(OPTIONAL)

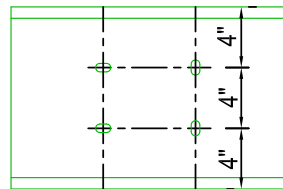

WEB PUNCHING
5/8" x 3/4" SLOTS
(STANDARD)

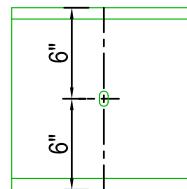

SAG ROD PUNCHING
5/8" x 3/4" SLOTS
(OPTIONAL)

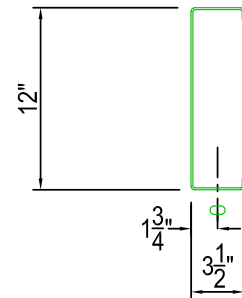

FLANGE PUNCHING
9/16" x 1" SLOTS
(OPTIONAL)

12" x 3 1/2" CEE

(AVAILABLE GAUGES - 14, 12 & 10)

(CALL FLEXOSPAN FOR ADDITIONAL PUNCH SIZES AND PUNCH OPTIONS)

14" x 2 1/2" CEE

(AVAILABLE GAUGES - 14, 12 & 10)

(CALL FLEXOSPAN FOR ADDITIONAL PUNCH SIZES AND PUNCH OPTIONS)

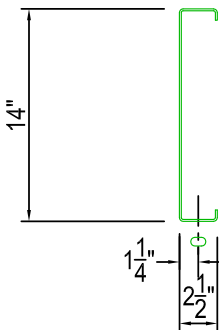

FLANGE PUNCHING
9/16" x 1" SLOTS
(OPTIONAL)

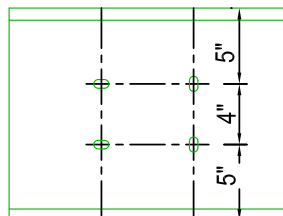

WEB PUNCHING
5/8" x 3/4" SLOTS
(STANDARD)

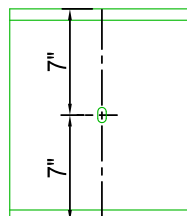

SAG ROD PUNCHING
5/8" x 3/4" SLOTS
(OPTIONAL)

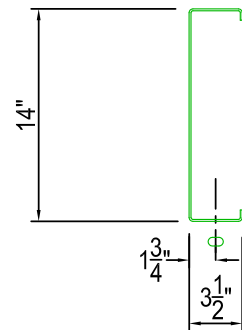

FLANGE PUNCHING
9/16" x 1" SLOTS
(OPTIONAL)

14" x 3 1/2" CEE

(AVAILABLE GAUGES - 14, 12 & 10)

(CALL FLEXOSPAN FOR ADDITIONAL PUNCH SIZES AND PUNCH OPTIONS)

FLEXOSPAN STANDARD PUNCHING FOR ZEE PURLINS AND GIRTS

STANDARD FINISHES : GALVANIZED, STAINLESS AND GRAY OXIDE

4" x 2 1/2" ZEE

(AVAILABLE GAUGES - 16, 14, & 12)

(CALL FLEXOSPAN FOR ADDITIONAL PUNCH SIZES AND PUNCH OPTIONS)

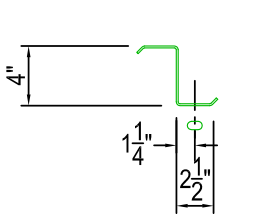

FLANGE PUNCHING
9/16" x 1" SLOTS
(OPTIONAL)

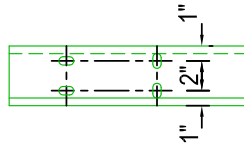

WEB PUNCHING
5/8" x 3/4" SLOTS
(STANDARD)

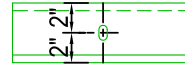

SAG ROD PUNCHING
5/8" x 3/4" SLOTS
(OPTIONAL)

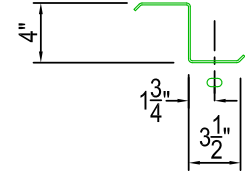

FLANGE PUNCHING
9/16" x 1" SLOTS
(OPTIONAL)

4" x 3 1/2" ZEE

(AVAILABLE GAUGES - 16, 14, & 12)

(CALL FLEXOSPAN FOR ADDITIONAL PUNCH SIZES AND PUNCH OPTIONS)

6" x 2 1/2" ZEE

(AVAILABLE GAUGES - 16, 14, 12 & 10)

(CALL FLEXOSPAN FOR ADDITIONAL PUNCH SIZES AND PUNCH OPTIONS)

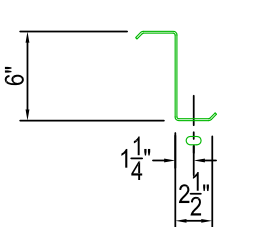

FLANGE PUNCHING
9/16" x 1" SLOTS
(OPTIONAL)

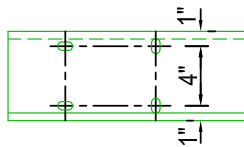

WEB PUNCHING
5/8" x 3/4" SLOTS
(STANDARD)

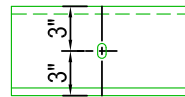

SAG ROD PUNCHING
5/8" x 3/4" SLOTS
(OPTIONAL)

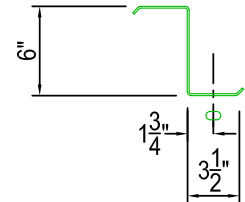

FLANGE PUNCHING
9/16" x 1" SLOTS
(OPTIONAL)

6" x 3 1/2" ZEE

(AVAILABLE GAUGES - 16, 14, 12 & 10)

(CALL FLEXOSPAN FOR ADDITIONAL PUNCH SIZES AND PUNCH OPTIONS)

8" x 2 1/2" ZEE

(AVAILABLE GAUGES - 16, 14, 12 & 10)

(CALL FLEXOSPAN FOR ADDITIONAL PUNCH SIZES AND PUNCH OPTIONS)

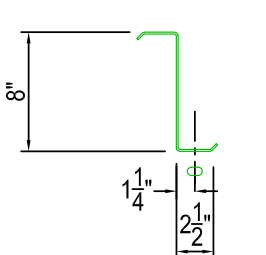

FLANGE PUNCHING
9/16" x 1" SLOTS
(OPTIONAL)

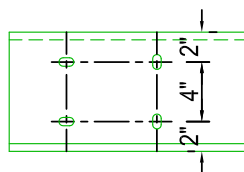

WEB PUNCHING
5/8" x 3/4" SLOTS
(STANDARD)

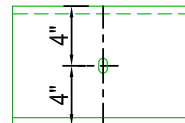

SAG ROD PUNCHING
5/8" x 3/4" SLOTS
(OPTIONAL)

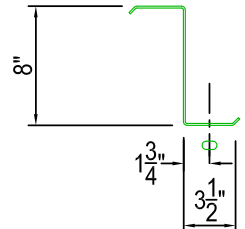

FLANGE PUNCHING
9/16" x 1" SLOTS
(OPTIONAL)

8" x 3 1/2" ZEE

(AVAILABLE GAUGES - 16, 14, 12 & 10)

(CALL FLEXOSPAN FOR ADDITIONAL PUNCH SIZES AND PUNCH OPTIONS)

FLEXOSPAN STANDARD PUNCHING FOR ZEE PURLINS AND GIRTS

STANDARD FINISHES : GALVANIZED, STAINLESS AND GRAY OXIDE

10" x 2 1/2" ZEE

(AVAILABLE GAUGES - 16, 14, 12 & 10)

(CALL FLEXOSPAN FOR ADDITIONAL PUNCH SIZES AND PUNCH OPTIONS)

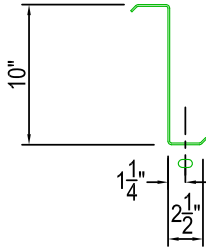

FLANGE PUNCHING
9/16" x 1" SLOTS
(OPTIONAL)

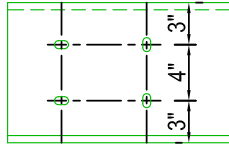

WEB PUNCHING
5/8" x 3/4" SLOTS
(STANDARD)

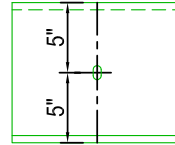

SAG ROD PUNCHING
5/8" x 3/4" SLOTS
(OPTIONAL)

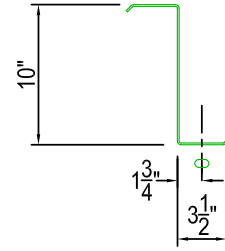

FLANGE PUNCHING
9/16" x 1" SLOTS
(OPTIONAL)

10" x 3 1/2" ZEE

(AVAILABLE GAUGES - 14, 12 & 10)

(CALL FLEXOSPAN FOR ADDITIONAL PUNCH SIZES AND PUNCH OPTIONS)

12" x 2 1/2" ZEE

(AVAILABLE GAUGES - 14, 12 & 10)

(CALL FLEXOSPAN FOR ADDITIONAL PUNCH SIZES AND PUNCH OPTIONS)

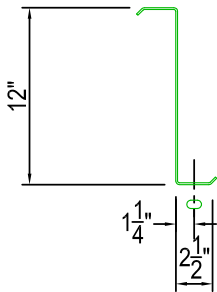

FLANGE PUNCHING
9/16" x 1" SLOTS
(OPTIONAL)

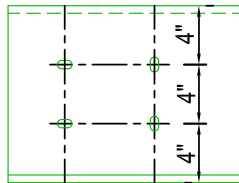

WEB PUNCHING
5/8" x 3/4" SLOTS
(STANDARD)

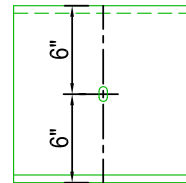

SAG ROD PUNCHING
5/8" x 3/4" SLOTS
(OPTIONAL)

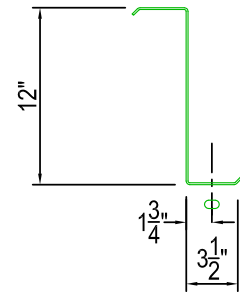

FLANGE PUNCHING
9/16" x 1" SLOTS
(OPTIONAL)

12" x 3 1/2" ZEE

(AVAILABLE GAUGES - 14, 12 & 10)

(CALL FLEXOSPAN FOR ADDITIONAL PUNCH SIZES AND PUNCH OPTIONS)

14" x 2 1/2" ZEE

(AVAILABLE GAUGES - 14, 12 & 10)

(CALL FLEXOSPAN FOR ADDITIONAL PUNCH SIZES AND PUNCH OPTIONS)

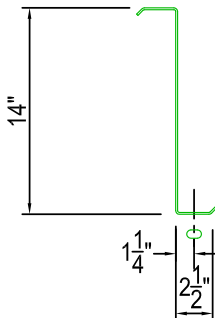

FLANGE PUNCHING
9/16" x 1" SLOTS
(OPTIONAL)

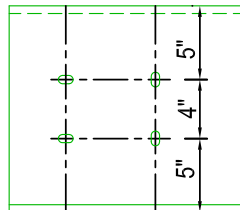

WEB PUNCHING
5/8" x 3/4" SLOTS
(STANDARD)

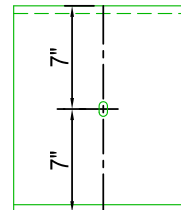

SAG ROD PUNCHING
5/8" x 3/4" SLOTS
(OPTIONAL)

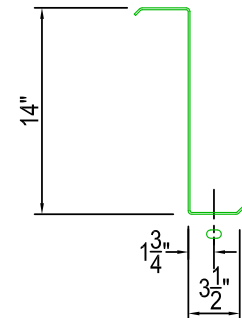

FLANGE PUNCHING
9/16" x 1" SLOTS
(OPTIONAL)

14" x 3 1/2" ZEE

(AVAILABLE GAUGES - 14, 12 & 10)

(CALL FLEXOSPAN FOR ADDITIONAL PUNCH SIZES AND PUNCH OPTIONS)

FLEXOSPAN LIGHT GAUGE PRODUCTS

CUSTOM SHAPES

(AVAILABLE GAUGES - CONTACT FLEXOSPAN)
(CALL FLEXOSPAN WITH YOUR SPECIAL SHAPE)

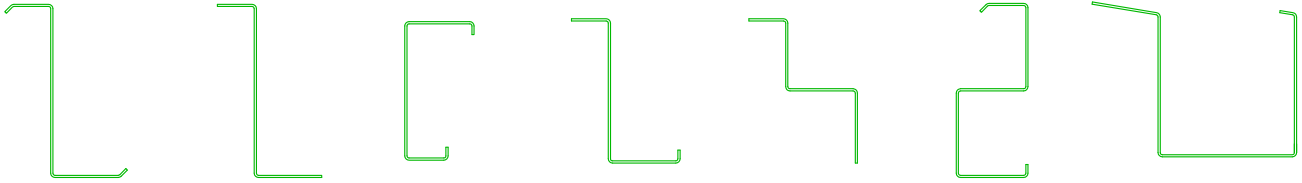

FLEXOSPAN ACCESSORIES

(AVAILABLE GAUGES - CONTACT FLEXOSPAN)

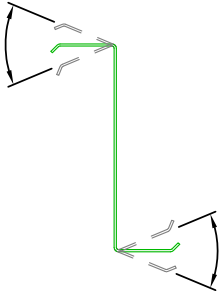

ZEE EAVE STRUTS
(BOTH FLANGES OR
ONE CAN BE PITCHED)

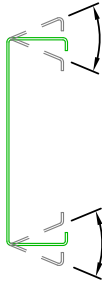

CEE EAVE STRUTS
(BOTH FLANGES OR
ONE CAN BE PITCHED)

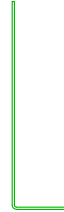

ANGLES
(CORNER, RAKE & BASE)

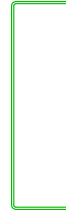

OPEN CHANNELS
(RAKE & BASE)



1/2" DEEP 3/4" DEEP



1 1/2" DEEP

SUBGIRTS
(STOCK LENGTH 20'-0")

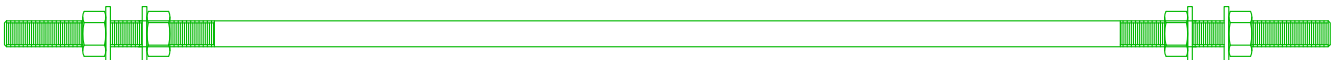

SAG RODS
(AVAILABLE IN 1/2", 5/8" AND 3/4" DIA.)

FLEXOSPAN STANDARD BOLT ON PURLIN AND GIRT CLIPS

PURLIN & GIRT CLIP "GC2-6, 8, 10, 12 & 14"

(OUTBOARD / BYPASS BOLT ON CLIP)

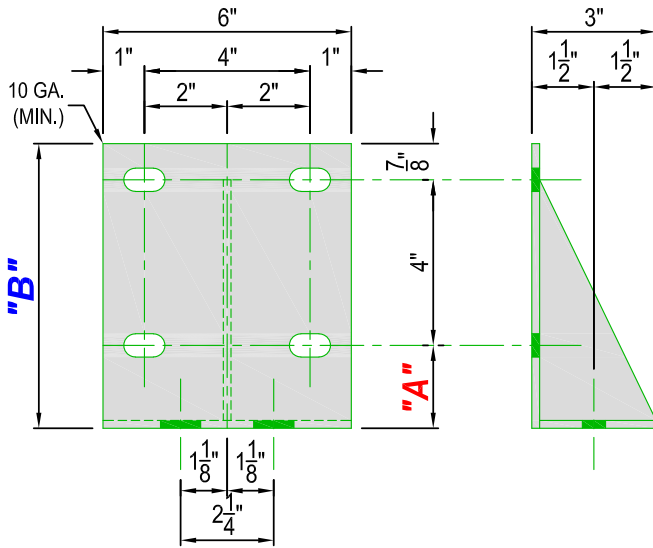

CEE OR ZEE	FLEXOSPAN STANDARD		CUSTOM SIZES	
	"A" DIM.	"B" DIM.	"A" DIM.	"B" DIM.
6"	1"	5 ⁷ / ₈ "		
8"	2"	6 ⁷ / ₈ "		
10"	3"	7 ⁷ / ₈ "		
12"	4"	8 ⁷ / ₈ "		
14"	5"	9 ⁷ / ₈ "		

** DIMENSIONS "A" & "B" TO BE PROVIDED BY CUSTOMER **
SLOTS = 9/16" x 1" (TYP.)

PURLIN & GIRT CLIP "PC2-6, 8, 10, 12 & 14"

(OUTBOARD / BYPASS BOLT ON CLIP)

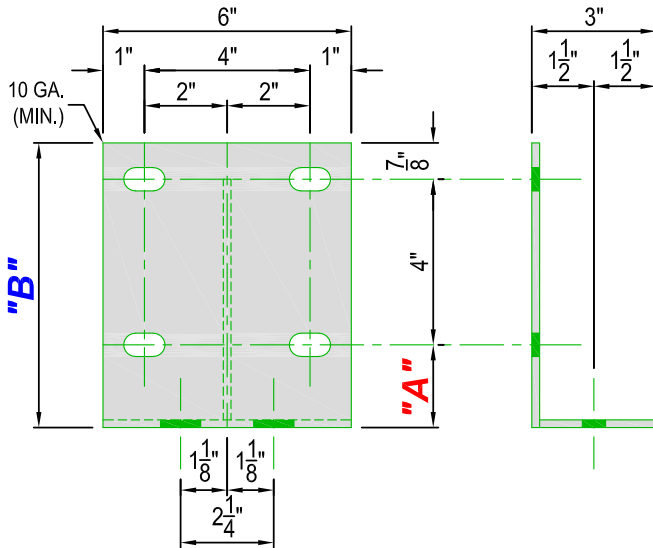

CEE OR ZEE	FLEXOSPAN STANDARD		CUSTOM SIZES	
	"A" DIM.	"B" DIM.	"A" DIM.	"B" DIM.
6"	1"	5 ⁷ / ₈ "		
8"	2"	6 ⁷ / ₈ "		
10"	3"	7 ⁷ / ₈ "		
12"	4"	8 ⁷ / ₈ "		
14"	5"	9 ⁷ / ₈ "		

** DIMENSIONS "A" & "B" TO BE PROVIDED BY CUSTOMER **
SLOTS = 9/16" x 1" (TYP.)

PURLIN & GIRT CLIP "GPC1"

(INBOARD / FLUSH BOLT ON CLIPS)

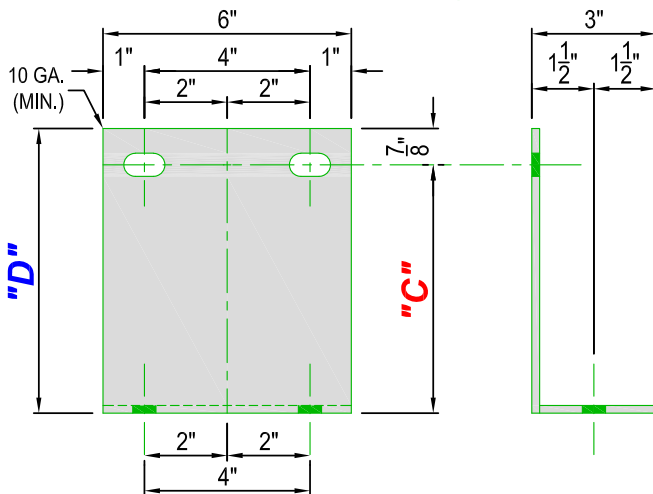

CEE OR ZEE	CUSTOM SIZES	
	"C" DIM.	"D" DIM.
6"		
8"		
10"		
12"		
14"		

** DIMENSIONS "C" & "D" TO BE PROVIDED BY CUSTOMER **
SLOTS = 9/16" x 1" (TYP.)

FLEXOSPAN STANDARD WELD ON PURLIN AND GIRT CLIPS

PURLIN & GIRT CLIP "GC1-6, 8, 10, 12 & 14"

(OUTBOARD / BYPASS WELD ON CLIP)

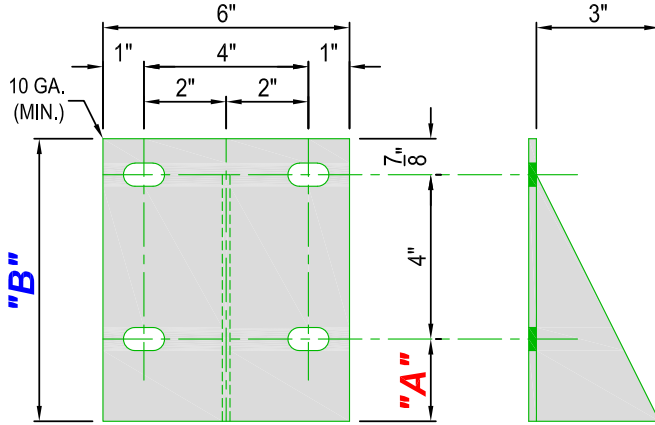

CEE OR ZEE	FLEXOSPAN STANDARD		CUSTOM SIZES	
	"A" DIM.	"B" DIM.	"A" DIM.	"B" DIM.
6"	1"	5 ⁷ / ₈ "		
8"	2"	6 ⁷ / ₈ "		
10"	3"	7 ⁷ / ₈ "		
12"	4"	8 ⁷ / ₈ "		
14"	5"	9 ⁷ / ₈ "		

**** DIMENSIONS "A" & "B" TO BE PROVIDED BY CUSTOMER ****
SLOTS = 9/16" x 1" (TYP.)

PURLIN & GIRT CLIP "PC1-6, 8, 10, 12 & 14"

(OUTBOARD / BYPASS WELD ON CLIP)

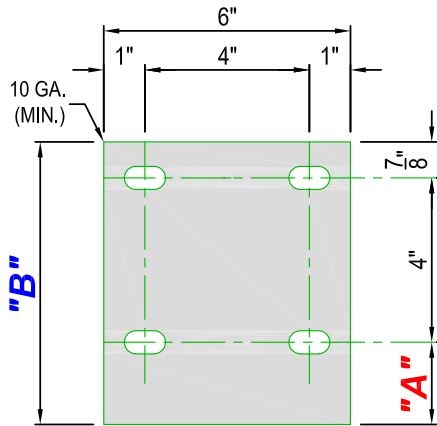

CEE OR ZEE	FLEXOSPAN STANDARD		CUSTOM SIZES	
	"A" DIM.	"B" DIM.	"A" DIM.	"B" DIM.
6"	1"	5 ⁷ / ₈ "		
8"	2"	6 ⁷ / ₈ "		
10"	3"	7 ⁷ / ₈ "		
12"	4"	8 ⁷ / ₈ "		
14"	5"	9 ⁷ / ₈ "		

**** DIMENSIONS "A" & "B" TO BE PROVIDED BY CUSTOMER ****
SLOTS = 9/16" x 1" (TYP.)

PURLIN & GIRT CLIP "GPC2"

(INBOARD / FLUSH WELD ON CLIPS)

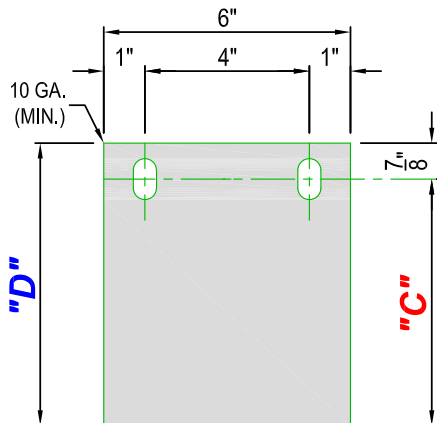

CEE OR ZEE	CUSTOM SIZES	
	"C" DIM.	"D" DIM.
6"		
8"		
10"		
12"		
14"		

**** DIMENSIONS "C" & "D" TO BE PROVIDED BY CUSTOMER ****
SLOTS = 9/16" x 1" (TYP.)

FLEXOSPAN STANDARD MULTI SPAN CEE AND ZEE PUNCH PATTERNS

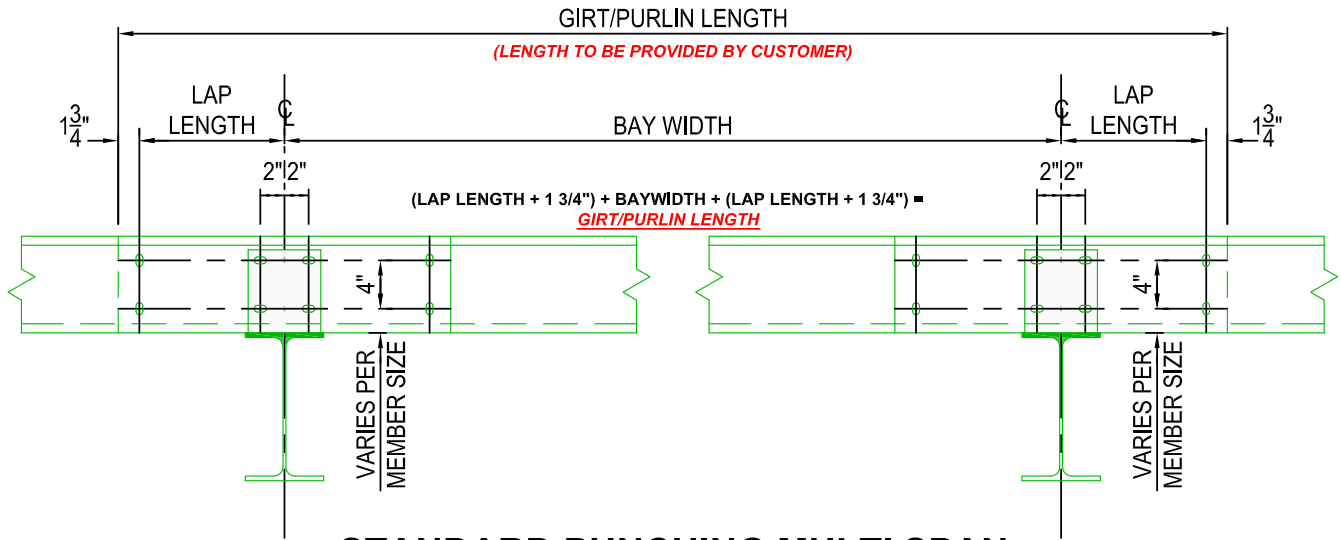

STANDARD PUNCHING MULTI SPAN

(OUTBOARD/BYPASS CLIPS)

FACTORY TOLERANCE = +/-1/4"

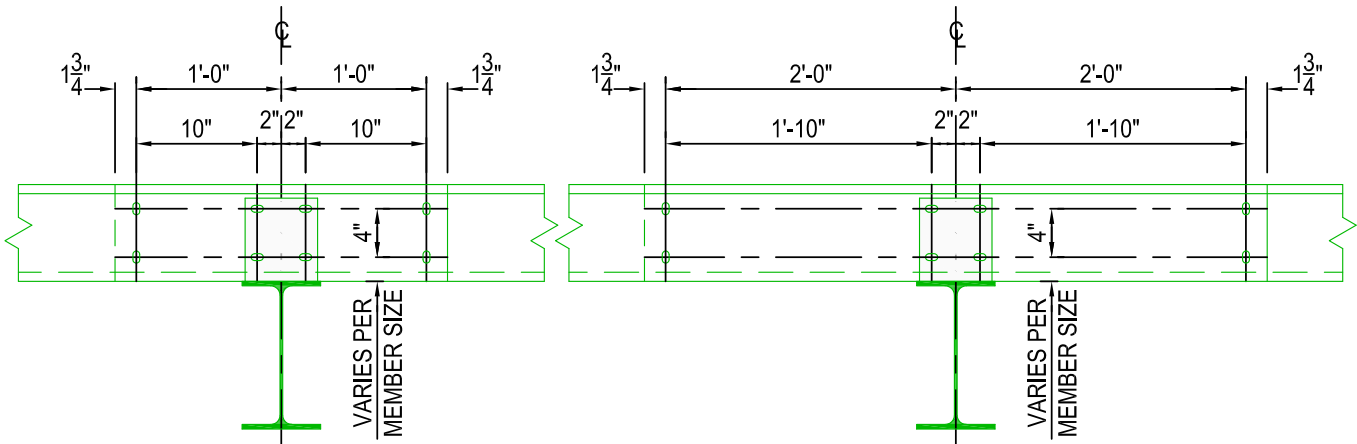

STANDARD 1'-0" LAP

STANDARD 2'-0" LAP

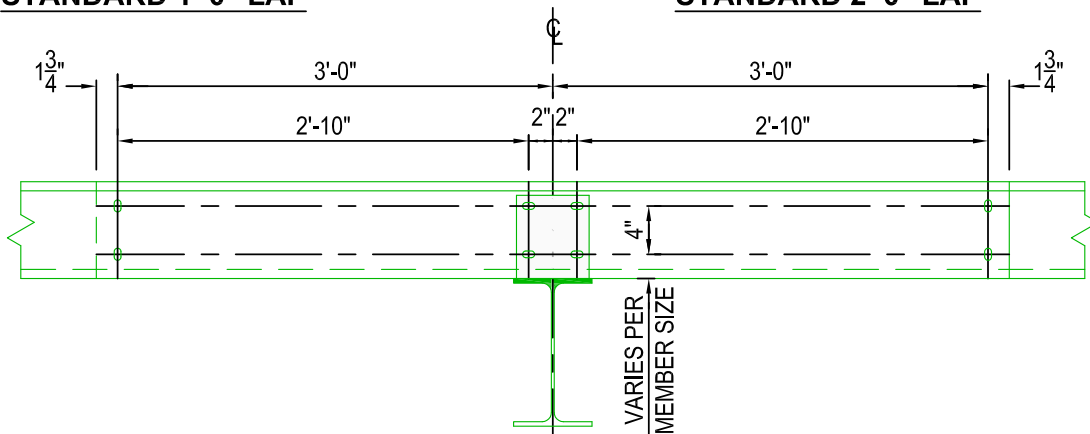

STANDARD 3'-0" LAP

FLEXOSPAN STANDARD SIMPLE SPAN CEE AND ZEE PUNCH PATTERNS

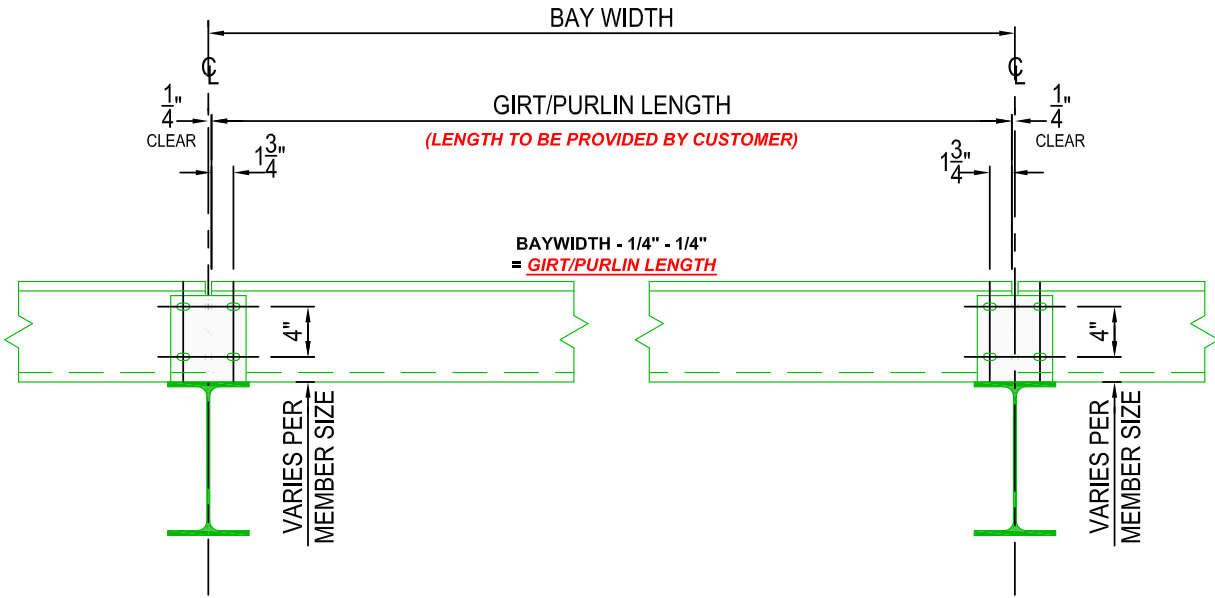

STANDARD PUNCHING OUTBOARD SIMPLE SPAN

(OUTBOARD/BYPASS CLIPS)

FACTORY TOLERANCE = +/- 1/4"

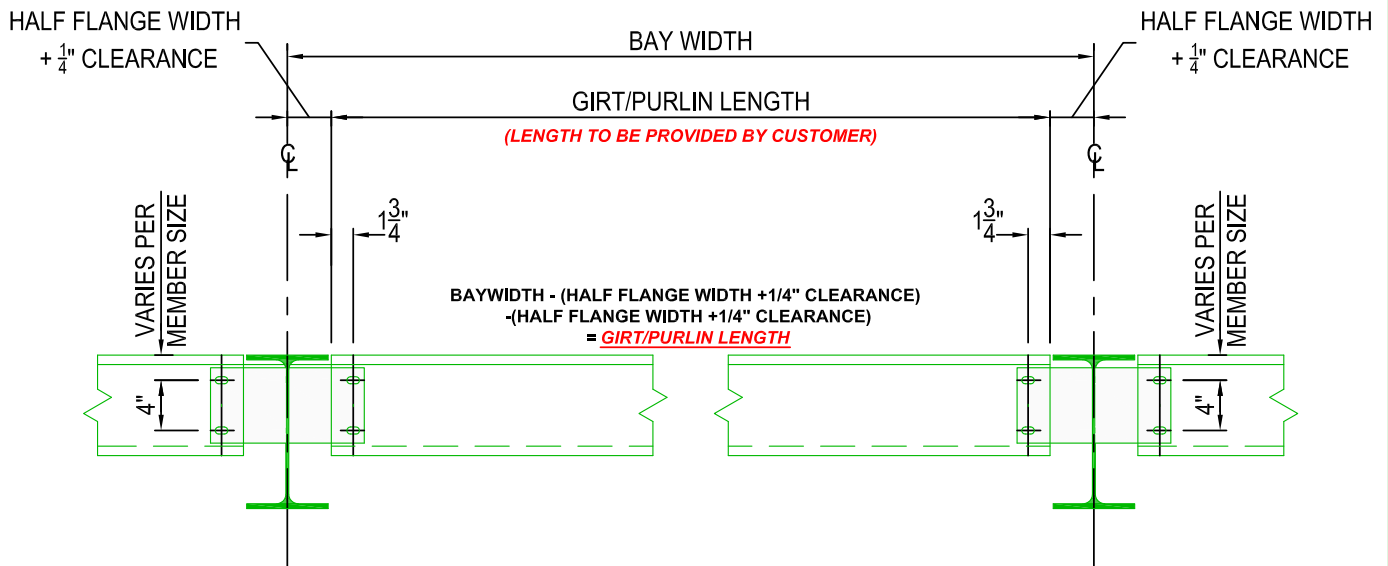

STANDARD PUNCHING INBOARD SIMPLE SPAN

(INBOARD/FLUSH CLIPS)

FACTORY TOLERANCE = +/- 1/4"

FLEXOSPAN EXAMPLE CEE PUNCHING LAYOUT

IMPORTANT NOTES: (All dimensions to be supplied by customer.)

- A. **OVERALL LENGTH** : Fabrication length of Cee.
- B. **WEB HOLES (STANDARD)** : Detail all punch dimensions from the start line (left to right) individually.
- C. **FLANGE HOLES : (OPTIONAL)** Detail all punch dimensions from the start line (left to right) individually.
- D. All dimensions will be associated with the Cee shape required for standard punching.
- E. Near or bottom flange is always turned up.
- F. All dimensions to be in inches.

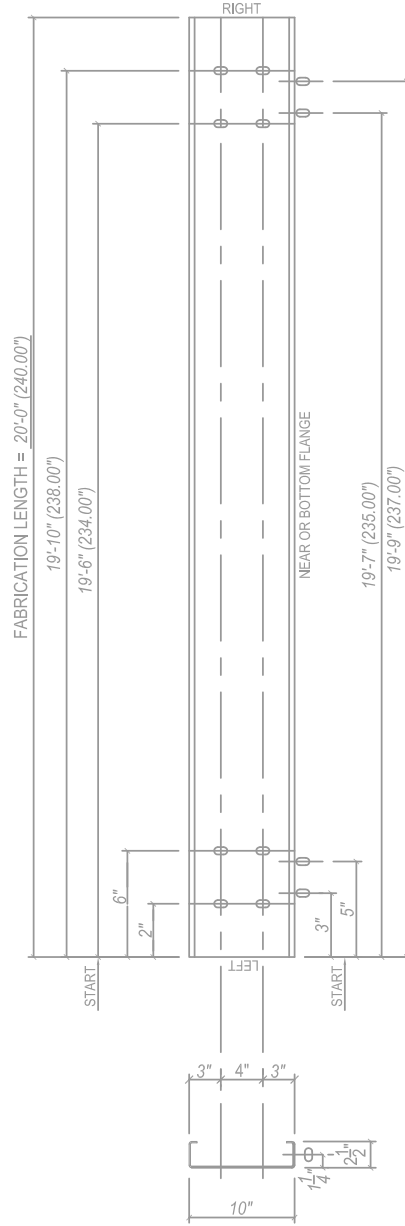
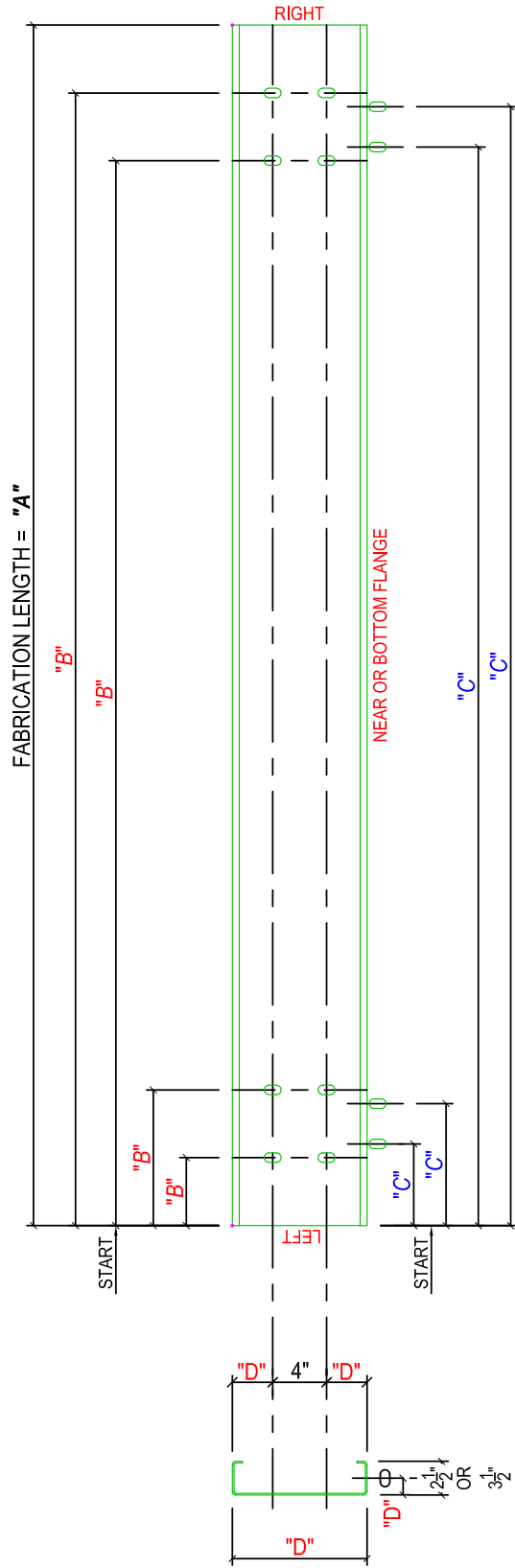

AN EXAMPLE OF CEE PUNCHING

BLANK FORM FOR CEE PUNCHING LAYOUT (DUPLICATE AS NEEDED)

IMPORTANT: SEE NOTES ON EXAMPLE CEE PUNCHING LAYOUT

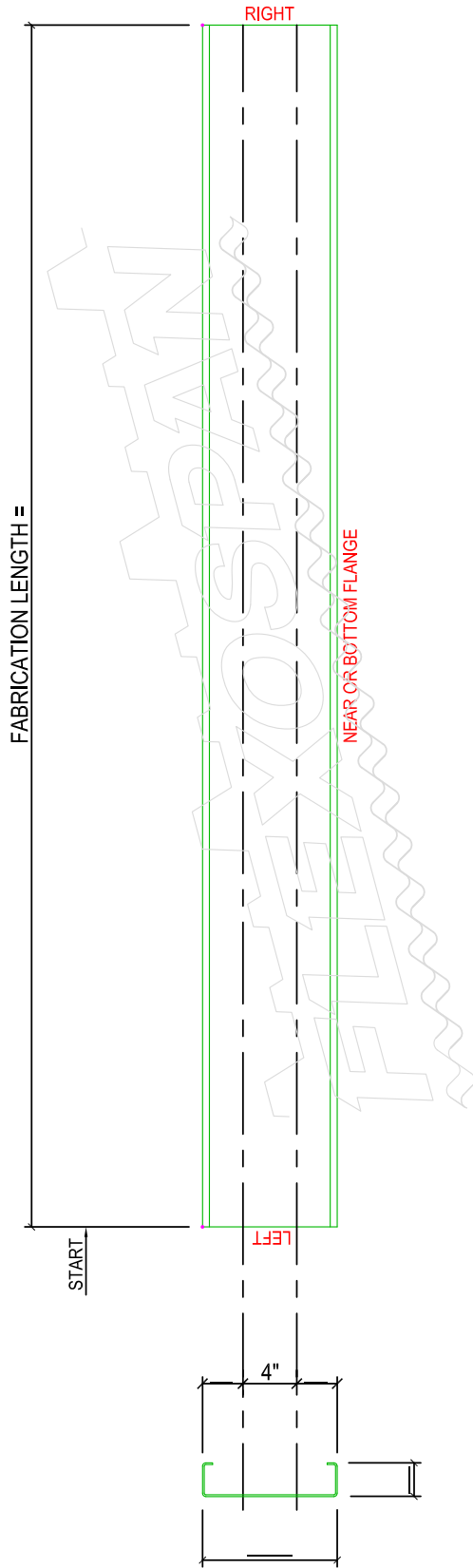

FABRICATION LENGTH =

PART NAME:

REQUIRED:

GAUGE:

FINISH:

IMPORTANT: SEE NOTES ON EXAMPLE CEE PUNCHING LAYOUT

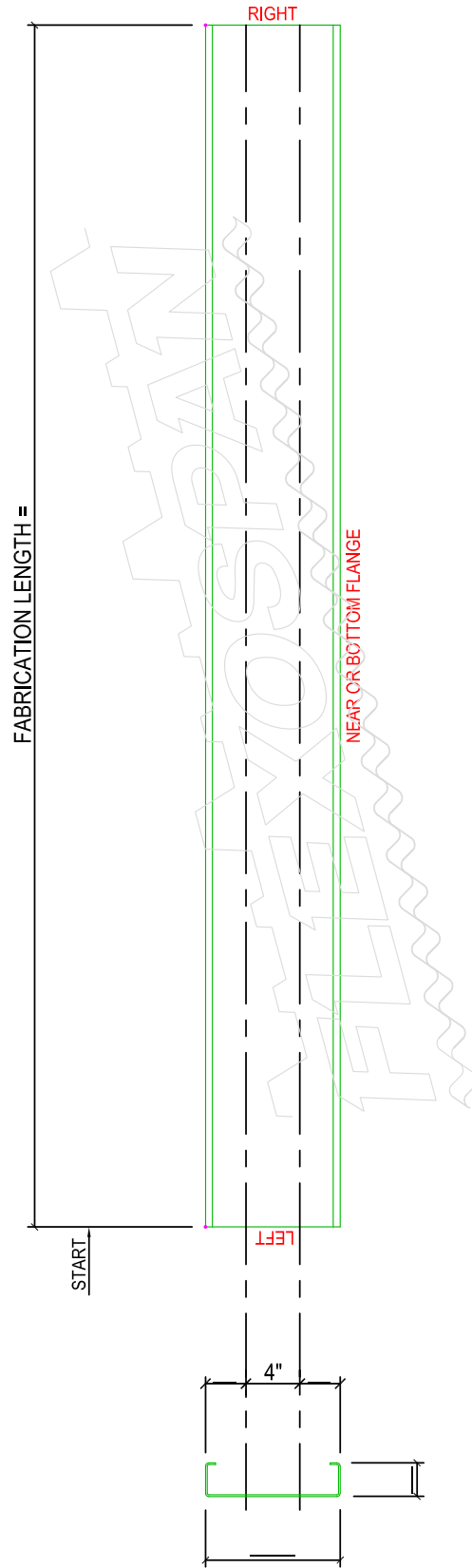

FABRICATION LENGTH =

PART NAME:

REQUIRED:

GAUGE:

FINISH:

FLEXOSPAN EXAMPLE ZEE PUNCHING LAYOUT

IMPORTANT NOTES: (All dimensions to be supplied by customer.)

- A. **OVERALL LENGTH** : Fabrication length of Zee.
- B. **WEB HOLES (STANDARD)** : Detail all punch dimensions from the start line (left to right) individually.
- C. **FLANGE HOLES** : (OPTIONAL) Detail all punch dimensions from the start line (left to right) individually.
- D. All dimensions will be associated with the Zee shape required for standard punching.
- E. Near or bottom flange is always turned up.
- F. All dimensions to be in inches.

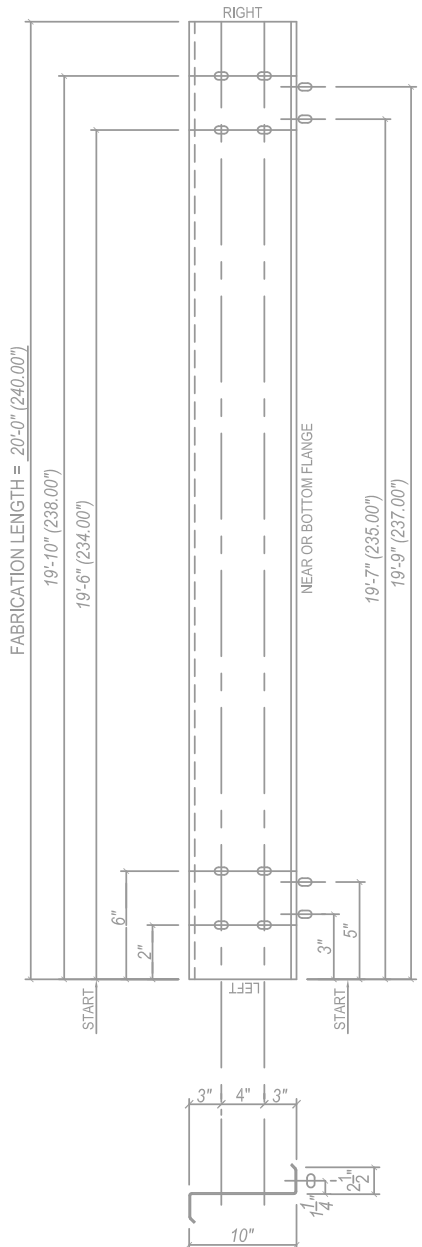
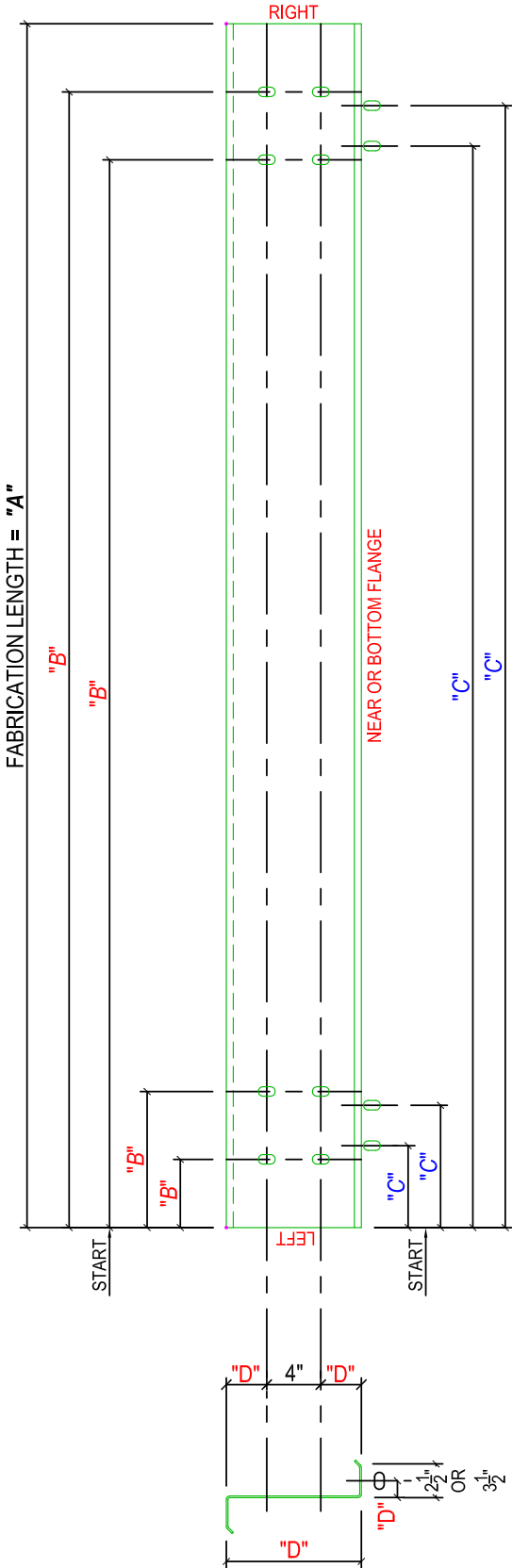

AN EXAMPLE OF ZEE PUNCHING

BLANK FORM FOR ZEE PUNCHING LAYOUT (DUPLICATE AS NEEDED)

IMPORTANT: SEE NOTES ON EXAMPLE ZEE PUNCHING LAYOUT

FABRICATION LENGTH =

PART NAME: _____

REQUIRED: _____

GAUGE: _____

FINISH: _____

IMPORTANT: SEE NOTES ON EXAMPLE ZEE PUNCHING LAYOUT

FABRICATION LENGTH =

PART NAME: _____

REQUIRED: _____

GAUGE: _____

FINISH: _____

FLEXOSPAN STANDARD LOAD TABLE FOR 4" AND 6" CEEs

Allowable uniform loads in Pounds per linear foot

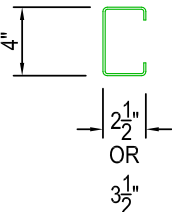
4" CEE		Simple Span								
		16 Gauge		14 Gauge		12 Gauge		10 Gauge		
Section	Bay		2 1/2" Fl.	3 1/2" Fl.	2 1/2" Fl.	3 1/2" Fl.	2 1/2" Fl.	3 1/2" Fl.	2 1/2" Fl.	3 1/2" Fl.
	8 ft	Lbs./Lf.	223	248	297	327	437	496	551	690
		Deflection	.450"	.385"	.487"	.412"	.529"	.459"	.536"	.511"
	10 ft	Lbs./Lf.	143	158	190	209	280	317	352	441
		Deflection	.704"	.599"	.761"	.643"	.827"	.716"	.836"	.797"
	12 ft	Lbs./Lf.	99	110	132	145	194	220	244	306
		Deflection	1.011"	.864"	1.097"	.925"	1.189"	1.031"	1.201"	1.147"
	14 ft	Lbs./Lf.	73	81	97	106	143	162	180	225
		Deflection	1.382"	1.179"	1.493"	1.253"	1.623"	1.407"	1.642"	1.563"
	16 ft	Lbs./Lf.	55	62	74	81	109	124	137	172
		Deflection	1.776"	1.540"	1.943"	1.633"	2.111"	1.837"	2.132"	2.038"
	18 ft	Lbs./Lf.	44	49	58	64	86	98	108	136
		Deflection	2.275"	1.949"	2.440"	2.067"	2.668"	2.325"	2.692"	2.582"
	20 ft	Lbs./Lf.	35	39	47	52	70	79	88	110
		Deflection	2.759"	2.365"	3.013"	2.560"	3.310"	2.857"	3.343"	3.183"

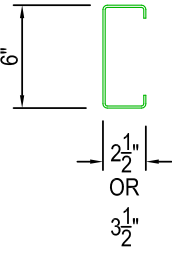
6" CEE		Simple Span								
		16 Gauge		14 Gauge		12 Gauge		10 Gauge		
Section	Bay		2 1/2" Fl.	3 1/2" Fl.	2 1/2" Fl.	3 1/2" Fl.	2 1/2" Fl.	3 1/2" Fl.	2 1/2" Fl.	3 1/2" Fl.
	8 ft	Lbs./Lf.	351	380	473	516	731	-	-	-
		Deflection	.278"	.237"	.303"	.261"	.344"	-	-	-
	10 ft	Lbs./Lf.	225	243	303	330	468	520	609	720
		Deflection	.435"	.370"	.475"	.407"	.537"	.469"	.558"	.516"
	12 ft	Lbs./Lf.	156	169	210	229	325	361	423	500
		Deflection	.625"	.534"	.682"	.586"	.773"	.674"	.803"	.743"
	14 ft	Lbs./Lf.	114	124	154	168	238	265	311	367
		Deflection	.846"	.726"	.926"	.796"	1.049"	.917"	1.094"	1.010"
	16 ft	Lbs./Lf.	87	95	118	129	182	203	238	281
		Deflection	1.101"	.949"	1.211"	1.043"	1.369"	1.199"	1.428"	1.320"
	18 ft	Lbs./Lf.	69	75	93	102	144	160	188	222
		Deflection	1.399"	1.200"	1.529"	1.321"	1.735"	1.513"	1.807"	1.670"
	20 ft	Lbs./Lf.	56	60	75	82	117	130	152	180
		Deflection	1.731"	1.463"	1.879"	1.619"	2.148"	1.874"	2.227"	2.064"
	22 ft	Lbs./Lf.	46	50	62	68	96	107	126	148
		Deflection	2.081"	1.785"	2.274"	1.965"	2.580"	2.258"	2.703"	2.485"
	24 ft	Lbs./Lf.	39	42	52	57	81	90	105	125
		Deflection	2.499"	2.124"	2.702"	2.333"	3.084"	2.690"	3.190"	2.972"
	26 ft	Lbs./Lf.	33	36	44	48	69	76	90	106
		Deflection	2.913"	2.508"	3.149"	2.706"	3.618"	3.129"	3.766"	3.471"
28 ft	Lbs./Lf.	28	31	38	42	59	65	77	91	
	Deflection	3.324"	2.904"	3.658"	3.185"	4.161"	3.600"	4.334"	4.009"	

Notes: 1. The weight of the section has not been subtracted from these values. 2. Both flanges of member must be fully braced. 3. These loads are based on the transfer of the support loads directly to the web of the section by the use of clips or plates. For flanges bearing directly on structural, contact factory for section selection. 4. Loads shown are based on 55 KSI yield strength steel. 5. Loads shown are stress governing. When deflection limits are specified, contact factory. 6. These sample calculations are very basic. Many different variables can affect loading. For instance; drift loading, building height, geographic location, etc. Please consult Flexospan if special conditions exist. 7. The selection of sections for your application is subject to final approval by your design professional. 8. Capacity values have been calculated in accordance with the AISI 2016 design manual. 9. Values shown in the load tables for three or more spans are based on uniform bay spacings. If non-uniform bay spacings exist, contact factory.

FLEXOSPAN STANDARD LOAD TABLE FOR 8" AND 10" CEEs

Allowable uniform loads in Pounds per linear foot

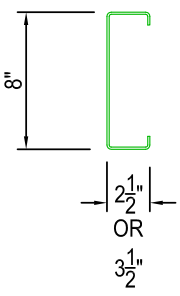
8" CEE		Simple Span								
		16 Gauge		14 Gauge		12 Gauge		10 Gauge		
Section	Bay		2 1/2" Fl.	3 1/2" Fl.	2 1/2" Fl.	3 1/2" Fl.	2 1/2" Fl.	3 1/2" Fl.	2 1/2" Fl.	3 1/2" Fl.
	12 ft	Lbs./Lf.	214	229	291	313	457	498	627	698
		Deflection	.436"	.376"	.480"	.415"	.550"	.480"	.602"	.534"
	14 ft	Lbs./Lf.	157	168	213	230	335	366	460	513
		Deflection	.593"	.510"	.651"	.565"	.747"	.654"	.819"	.727"
	16 ft	Lbs./Lf.	120	128	163	176	257	280	353	392
		Deflection	.773"	.663"	.850"	.737"	.978"	.854"	1.072"	.948"
	18 ft	Lbs./Lf.	95	101	129	139	203	221	278	310
		Deflection	.980"	.839"	1.077"	.933"	1.238"	1.079"	1.352"	1.200"
	20 ft	Lbs./Lf.	77	82	104	112	164	179	225	251
		Deflection	1.211"	1.038"	1.324"	1.145"	1.524"	1.333"	1.668"	1.481"
	22 ft	Lbs./Lf.	63	68	86	93	136	148	186	207
		Deflection	1.451"	1.260"	1.603"	1.393"	1.850"	1.613"	2.019"	1.789"
	24 ft	Lbs./Lf.	53	57	72	78	114	124	156	174
		Deflection	1.729"	1.496"	1.901"	1.654"	2.197"	1.914"	2.398"	2.130"
	26 ft	Lbs./Lf.	45	48	62	66	97	106	133	148
		Deflection	2.022"	1.735"	2.254"	1.928"	2.574"	2.254"	2.816"	2.495"
	28 ft	Lbs./Lf.	39	42	53	57	83	91	115	128
		Deflection	2.357"	2.042"	2.592"	2.239"	2.963"	2.602"	3.275"	2.902"
30 ft	Lbs./Lf.	34	36	46	50	73	79	100	111	
	Deflection	2.708"	2.306"	2.964"	2.589"	3.434"	2.977"	3.753"	3.317"	

10" CEE		Simple Span								
		16 Gauge		14 Gauge		12 Gauge		10 Gauge		
Section	Bay		2 1/2" Fl.	3 1/2" Fl.	2 1/2" Fl.	3 1/2" Fl.	2 1/2" Fl.	3 1/2" Fl.	2 1/2" Fl.	3 1/2" Fl.
	20 ft	Lbs./Lf.	97	-	133	143	212	230	295	324
		Deflection	.896"	-	.993"	.871"	1.152"	1.018"	1.276"	1.138"
	22 ft	Lbs./Lf.	80	-	110	118	175	190	244	267
		Deflection	1.082"	-	1.202"	1.053"	1.393"	1.231"	1.545"	1.373"
	24 ft	Lbs./Lf.	67	-	92	99	147	159	205	224
		Deflection	1.283"	-	1.424"	1.251"	1.657"	1.459"	1.838"	1.632"
	26 ft	Lbs./Lf.	57	-	78	84	125	136	175	191
		Deflection	1.503"	-	1.663"	1.462"	1.940"	1.719"	2.162"	1.916"
	28 ft	Lbs./Lf.	49	-	68	73	108	117	150	165
		Deflection	1.738"	-	1.950"	1.709"	2.255"	1.989"	2.492"	2.227"
	30 ft	Lbs./Lf.	43	-	59	63	94	102	131	144
		Deflection	2.010"	-	2.229"	1.943"	2.586"	2.285"	2.868"	2.561"
	32 ft	Lbs./Lf.	38	-	52	55	82	89	115	126
		Deflection	2.300"	-	2.544"	2.196"	2.921"	2.581"	3.260"	2.901"
	34 ft	Lbs./Lf.	33	-	46	49	73	79	102	112
		Deflection	2.545"	-	2.868"	2.493"	3.314"	2.920"	3.684"	3.286"
	36 ft	Lbs./Lf.	30	-	41	44	65	71	91	100
		Deflection	2.908"	-	3.212"	2.814"	3.708"	3.298"	4.132"	3.688"
36 ft	Lbs./Lf.	26	-	36	39	58	63	81	89	
	Deflection	3.129"	-	3.502"	3.097"	4.108"	3.633"	4.475"	4.075"	

Notes: 1. The weight of the section has not been subtracted from these values. 2. Both flanges of member must be fully braced. 3. These loads are based on the transfer of the support loads directly to the web of the section by the use of clips or plates. For flanges bearing directly on structural, contact factory for section selection. 4. Loads shown are based on 55 KSI yield strength steel. 5. Loads shown are stress governing. When deflection limits are specified, contact factory. 6. These sample calculations are very basic. Many different variables can affect loading. For instance; drift loading, building height, geographic location, etc. Please consult Flexospan if special conditions exist. 7. The selection of sections for your application is subject to final approval by your design professional. 8. Capacity values have been calculated in accordance with the AISI 2016 design manual. 9. Values shown in the load tables for three or more spans are based on uniform bay spacings. If non-uniform bay spacings exist, contact factory.

FLEXOSPAN STANDARD LOAD TABLE FOR 12" AND 14" CEES

Allowable uniform loads in Pounds per linear foot

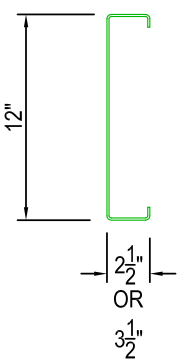
12" CEE		Simple Span								
Section	Bay	16 Gauge		14 Gauge		12 Gauge		10 Gauge		
		2 1/2" Fl.	3 1/2" Fl.	2 1/2" Fl.	3 1/2" Fl.	2 1/2" Fl.	3 1/2" Fl.	2 1/2" Fl.	3 1/2" Fl.	
	20 ft	Lbs./Lf.	-	-	160	173	258	280	366	400
		Deflection	-	-	.767"	.0686"	.599"	.805"	1.009"	.906"
	22 ft	Lbs./Lf.	-	-	132	143	213	232	303	331
		Deflection	-	-	.926"	.830"	1.086"	.977"	1.223"	1.101"
	24 ft	Lbs./Lf.	-	-	111	120	179	195	254	278
		Deflection	-	-	1.103"	.987"	1.293"	1.163"	1.452"	1.309"
	26 ft	Lbs./Lf.	-	-	94	102	153	166	217	237
		Deflection	-	-	1.287"	1.155"	1.522"	1.364"	1.709"	1.538"
	28 ft	Lbs./Lf.	-	-	81	88	132	143	187	204
		Deflection	-	-	1.491"	1.341"	1.766"	1.580"	1.981"	1.780"
	30 ft	Lbs./Lf.	-	-	71	77	114	124	163	178
		Deflection	-	-	1.723"	1.546"	2.010"	1.805"	2.275"	2.047"
	32 ft	Lbs./Lf.	-	-	62	67	101	109	143	156
		Deflection	-	-	1.948"	1.741"	2.306"	2.054"	2.584"	2.322"
	34 ft	Lbs./Lf.	-	-	55	59	89	97	126	138
		Deflection	-	-	2.202"	1.954"	2.589"	2.330"	2.902"	2.618"
	36 ft	Lbs./Lf.	-	-	49	53	79	86	113	123
		Deflection	-	-	2.465"	2.206"	2.889"	2.596"	3.271"	2.933"
	38 ft	Lbs./Lf.	-	-	44	47	71	77	101	111
		Deflection	-	-	2.748"	2.429"	3.223"	2.886"	3.629"	3.286"
40 ft	Lbs./Lf.	-	-	40	43	64	70	91	100	
	Deflection	-	-	3.068"	2.728"	3.567"	3.221"	4.015"	3.634"	

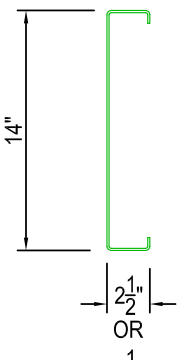
14" CEE		Simple Span								
Section	Bay	16 Gauge		14 Gauge		12 Gauge		10 Gauge		
		2 1/2" Fl.	3 1/2" Fl.	2 1/2" Fl.	3 1/2" Fl.	2 1/2" Fl.	3 1/2" Fl.	2 1/2" Fl.	3 1/2" Fl.	
	22 ft	Lbs./Lf.	-	-	152	166	249	273	358	392
		Deflection	-	-	.730"	.667"	.867"	.795"	.986"	.900"
	24 ft	Lbs./Lf.	-	-	128	140	209	229	301	330
		Deflection	-	-	.870"	.797"	1.031"	.944"	1.174"	1.073"
	26 ft	Lbs./Lf.	-	-	109	119	178	195	256	281
		Deflection	-	-	1.021"	.933"	1.210"	1.107"	1.375"	1.259"
	28 ft	Lbs./Lf.	-	-	94	103	154	168	221	242
		Deflection	-	-	1.184"	1.086"	1.408"	1.283"	1.597"	1.458"
	30 ft	Lbs./Lf.	-	-	81	89	134	146	192	211
		Deflection	-	-	1.345"	1.237"	1.614"	1.469"	1.828"	1.675"
	32 ft	Lbs./Lf.	-	-	72	78	117	129	169	185
		Deflection	-	-	1.547"	1.403"	1.825"	1.681"	2.083"	1.901"
	34 ft	Lbs./Lf.	-	-	63	69	104	114	150	164
		Deflection	-	-	1.725"	1.582"	2.067"	1.893"	2.356"	2.148"
	36 ft	Lbs./Lf.	-	-	56	62	93	101	133	146
		Deflection	-	-	1.928"	1.786"	2.323"	2.108"	2.626"	2.404"
	38 ft	Lbs./Lf.	-	-	51	55	83	91	120	131
		Deflection	-	-	2.179"	1.967"	2.574"	2.358"	2.941"	2.677"
	40 ft	Lbs./Lf.	-	-	46	50	75	82	108	118
		Deflection	-	-	2.413"	2.196"	2.855"	2.608"	3.250"	2.961"
42 ft	Lbs./Lf.	-	-	41	45	68	74	98	107	
	Deflection	-	-	2.615"	2.402"	3.147"	2.861"	3.585"	3.263"	

Notes: 1. The weight of the section has not been subtracted from these values. 2. Both flanges of member must be fully braced. 3. These loads are based on the transfer of the support loads directly to the web of the section by the use of clips or plates. For flanges bearing directly on structural, contact factory for section selection. 4. Loads shown are based on 55 KSI yield strength steel. 5. Loads shown are stress governing. When deflection limits are specified, contact factory. 6. These sample calculations are very basic. Many different variables can affect loading. For instance; drift loading, building height, geographic location, etc. Please consult Flexospan if special conditions exist. 7. The selection of sections for your application is subject to final approval by your design professional. 8. Capacity values have been calculated in accordance with the AISI 2016 design manual. 9. Values shown in the load tables for three or more spans are based on uniform bay spacings. If non-uniform bay spacings exist, contact factory.

FLEXOSPAN STANDARD LOAD TABLE FOR 4" ZEEES

Allowable uniform loads in Pounds per linear foot

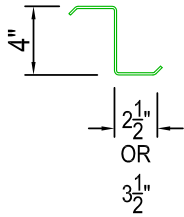
4" ZEE		Simple Span								
		16 Gauge		14 Gauge		12 Gauge		10 Gauge		
Section	Bay		2 1/2" Fl.	3 1/2" Fl.	2 1/2" Fl.	3 1/2" Fl.	2 1/2" Fl.	3 1/2" Fl.	2 1/2" Fl.	3 1/2" Fl.
	8 ft	Lbs./Lf.	201	220	277	306	432	484	587	670
		Deflection	.383"	.326"	.421"	.363"	.485"	.423"	.532"	.470"
	10 ft	Lbs./Lf.	128	141	177	195	276	309	376	429
		Deflection	.595"	.511"	.656"	.565"	.756"	.659"	.832"	.734"
	12 ft	Lbs./Lf.	89	98	123	136	192	215	261	298
		Deflection	.858"	.736"	.945"	.817"	1.091"	.950"	1.197"	1.059"
	14 ft	Lbs./Lf.	65	72	90	99	141	158	191	219
		Deflection	1.160"	1.002"	1.282"	1.102"	1.484"	1.294"	1.623"	1.442"
	16 ft	Lbs./Lf.	50	55	69	76	108	121	146	167
		Deflection	1.523"	1.306"	1.676"	1.443"	1.939"	1.690"	2.117"	1.876"
	18 ft	Lbs./Lf.	39	43	54	60	85	95	116	132
		Deflection	1.903"	1.635"	2.101"	1.825"	2.444"	2.126"	2.694"	2.375"
	20 ft	Lbs./Lf.	32	35	44	48	69	77	94	107
		Deflection	2.379"	2.029"	2.610"	2.225"	3.024"	2.626"	3.327"	2.935"

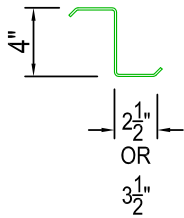
4" ZEE		3 or More Spans, Std. Lap								
		16 Gauge		14 Gauge		12 Gauge		10 Gauge		
Section	Bay		2 1/2" Fl.	3 1/2" Fl.	2 1/2" Fl.	3 1/2" Fl.	2 1/2" Fl.	3 1/2" Fl.	2 1/2" Fl.	3 1/2" Fl.
	8 ft	Lbs./Lf.	333	366	460	507	715	802	973	1111
		Deflection	.307"	.263"	.338"	.291"	.389"	.339"	.427"	.378"
	10 ft	Lbs./Lf.	211	232	292	321	454	508	617	704
		Deflection	.480"	.412"	.530"	.456"	.609"	.531"	.669"	.591"
	12 ft	Lbs./Lf.	145	160	201	221	313	350	426	486
		Deflection	.691"	.594"	.764"	.656"	.879"	.765"	.966"	.854"
	14 ft	Lbs./Lf.	106	116	147	162	228	256	311	355
		Deflection	.943"	.804"	1.043"	.898"	1.195"	1.044"	1.317"	1.165"
	16 ft	Lbs./Lf.	81	89	112	123	174	195	234	270
		Deflection	1.236"	1.059"	1.363"	1.170"	1.565"	1.365"	1.700"	1.520"
	18 ft	Lbs./Lf.	62	68	85	94	133	149	180	207
		Deflection	1.523"	1.302"	1.666"	1.439"	1.926"	1.679"	2.105"	1.876"
	20 ft	Lbs./Lf.	49	54	67	74	105	118	142	164
		Deflection	1.842"	1.583"	2.009"	1.734"	2.327"	2.035"	2.542"	2.274"

Notes: 1. The weight of the section has not been subtracted from these values. 2. Both flanges of member must be fully braced. 3. These loads are based on the transfer of the support loads directly to the web of the section by the use of clips or plates. For flanges bearing directly on structural, contact factory for section selection. 4. Loads shown are based on 55 KSI yield strength steel. 5. Loads shown are stress governing. When deflection limits are specified, contact factory. 6. These sample calculations are very basic. Many different variables can affect loading. For instance; drift loading, building height, geographic location, etc. Please consult Flexospan if special conditions exist. 7. The selection of sections for your application is subject to final approval by your design professional. 8. Capacity values have been calculated in accordance with the AISI 2016 design manual. 9. Values shown in the load tables for three or more spans are based on uniform bay spacings. If non-uniform bay spacings exist, contact factory.

Contact us @ (800) 245-0396
or SALES@FLEXOSPAN.COM



Visit our website
WWW.FLEXOSPAN.COM

FLEXOSPAN STANDARD LOAD TABLE FOR 6" ZEES

Allowable uniform loads in Pounds per linear foot

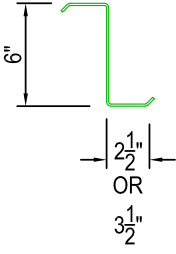
6" ZEE		Simple Span								
Section	Bay	16 Gauge		14 Gauge		12 Gauge		10 Gauge		
		2 1/2" Fl.	3 1/2" Fl.	2 1/2" Fl.	3 1/2" Fl.	2 1/2" Fl.	3 1/2" Fl.	2 1/2" Fl.	3 1/2" Fl.	
	8 ft	Lbs./Lf.	312	335	428	462	685	747	957	1058
		Deflection	.235"	.201"	.261"	.224"	.304"	.264"	.338"	.297"
	10 ft	Lbs./Lf.	200	214	274	295	438	478	612	677
		Deflection	.368"	.314"	.408"	.350"	.475"	.412"	.528"	.463"
	12 ft	Lbs./Lf.	138	149	190	205	304	332	425	470
		Deflection	.527"	.453"	.586"	.504"	.683"	.593"	.761"	.667"
	14 ft	Lbs./Lf.	102	109	140	151	223	244	312	345
		Deflection	.721"	.614"	.800"	.687"	.929"	.808"	1.034"	.907"
	16 ft	Lbs./Lf.	78	83	107	115	171	186	239	264
		Deflection	.941"	.798"	1.044"	.893"	1.215"	1.050"	1.352"	1.184"
	18 ft	Lbs./Lf.	61	66	84	91	135	147	189	209
		Deflection	1.179"	1.017"	1.312"	1.132"	1.536"	1.330"	1.712"	1.502"
	20 ft	Lbs./Lf.	50	53	68	74	109	119	153	169
		Deflection	1.473"	1.244"	1.619"	1.403"	1.891"	1.640"	2.113"	1.851"
	22 ft	Lbs./Lf.	41	44	56	61	90	98	126	139
		Deflection	1.768"	1.512"	1.952"	1.693"	2.286"	1.978"	2.547"	2.229"
	24 ft	Lbs./Lf.	34	37	47	51	76	83	106	117
		Deflection	2.077"	1.801"	2.321"	2.005"	2.734"	2.372"	3.035"	2.657"
	26 ft	Lbs./Lf.	29	31	40	43	64	70	90	100
		Deflection	2.440"	2.079"	2.720"	2.329"	3.171"	2.756"	3.550"	3.128"
28 ft	Lbs./Lf.	25	27	35	37	55	61	78	86	
	Deflection	2.829"	2.435"	3.202"	2.695"	3.665"	3.230"	4.138"	3.618"	

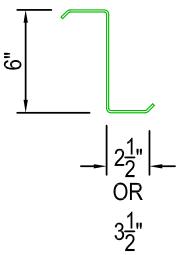
6" ZEE		3 or More Spans, Std. Lap								
Section	Bay	16 Gauge		14 Gauge		12 Gauge		10 Gauge		
		2 1/2" Fl.	3 1/2" Fl.	2 1/2" Fl.	3 1/2" Fl.	2 1/2" Fl.	3 1/2" Fl.	2 1/2" Fl.	3 1/2" Fl.	
	8 ft	Lbs./Lf.	518	556	710	766	1136	1239	1586	1753
		Deflection	.189"	.162"	.210"	.180"	.244"	.212"	.272"	.238"
	10 ft	Lbs./Lf.	328	353	450	486	720	785	1006	1112
		Deflection	.296"	.254"	.328"	.282"	.382"	.331"	.425"	.373"
	12 ft	Lbs./Lf.	226	243	310	335	497	542	693	767
		Deflection	.427"	.366"	.473"	.407"	.553"	.479"	.613"	.538"
	14 ft	Lbs./Lf.	165	177	227	245	363	396	507	560
		Deflection	.581"	.497"	.646"	.556"	.753"	.653"	.837"	.733"
	16 ft	Lbs./Lf.	126	135	173	186	276	302	386	427
		Deflection	.762"	.650"	.846"	.724"	.983"	.854"	1.094"	.960"
	18 ft	Lbs./Lf.	96	103	132	143	212	231	296	327
		Deflection	.934"	.799"	1.039"	.896"	1.215"	1.052"	1.350"	1.183"
	20 ft	Lbs./Lf.	76	82	104	113	167	183	234	259
		Deflection	1.132"	.973"	1.252"	1.083"	1.465"	1.276"	1.634"	1.434"
	22 ft	Lbs./Lf.	62	66	85	91	135	148	189	209
		Deflection	1.357"	1.151"	1.504"	1.282"	1.740"	1.516"	1.939"	1.700"
	24 ft	Lbs./Lf.	51	55	70	75	112	122	157	173
		Deflection	1.585"	1.363"	1.759"	1.501"	2.050"	1.775"	2.288"	1.999"
	26 ft	Lbs./Lf.	43	46	59	63	94	103	132	145
		Deflection	1.846"	1.574"	2.047"	1.741"	2.376"	2.069"	2.656"	2.314"
28 ft	Lbs./Lf.	36	39	50	54	80	87	112	124	
	Deflection	2.083"	1.799"	2.339"	2.011"	2.726"	2.356"	3.038"	2.668"	

Notes: 1. The weight of the section has not been subtracted from these values. 2. Both flanges of member must be fully braced. 3. These loads are based on the transfer of the support loads directly to the web of the section by the use of clips or plates. For flanges bearing directly on structural, contact factory for section selection. 4. Loads shown are based on 55 KSI yield strength steel. 5. Loads shown are stress governing. When deflection limits are specified, contact factory. 6. These sample calculations are very basic. Many different variables can affect loading. For instance; drift loading, building height, geographic location, etc. Please consult Flexospan if special conditions exist. 7. The selection of sections for your application is subject to final approval by your design professional. 8. Capacity values have been calculated in accordance with the AISI 2016 design manual. 9. Values shown in the load tables for three or more spans are based on uniform bay spacings. If non-uniform bay spacings exist, contact factory.

FLEXOSPAN STANDARD LOAD TABLE FOR 8" ZEEES

Allowable uniform loads in Pounds per linear foot

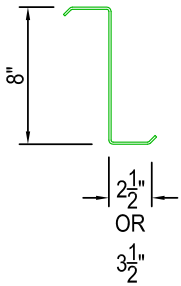
8" ZEE		Simple Span								
		16 Gauge		14 Gauge		12 Gauge		10 Gauge		
Section	Bay		2 1/2" Fl.	3 1/2" Fl.	2 1/2" Fl.	3 1/2" Fl.	2 1/2" Fl.	3 1/2" Fl.	2 1/2" Fl.	3 1/2" Fl.
	12 ft	Lbs./Lf.	189	201	261	279	425	457	602	625
		Deflection	.370"	.319"	.412"	.357"	.487"	.424"	.547"	.472"
	14 ft	Lbs./Lf.	139	148	192	205	312	335	442	459
		Deflection	.504"	.435"	.561"	.486"	.662"	.575"	.744"	.642"
	16 ft	Lbs./Lf.	106	113	147	157	239	257	338	351
		Deflection	.655"	.566"	.733"	.635"	.866"	.753"	.971"	.838"
	18 ft	Lbs./Lf.	84	89	116	124	189	203	267	278
		Deflection	.832"	.714"	.927"	.803"	1.096"	.953"	1.229"	1.063"
	20 ft	Lbs./Lf.	68	72	94	100	153	164	216	225
		Deflection	1.026"	.881"	1.145"	.987"	1.353"	1.173"	1.515"	1.311"
	22 ft	Lbs./Lf.	56	60	78	83	126	136	179	186
		Deflection	1.237"	1.075"	1.391"	1.199"	1.631"	1.424"	1.839"	1.587"
	24 ft	Lbs./Lf.	47	50	65	69	106	114	150	156
		Deflection	1.470"	1.269"	1.641"	1.412"	1.943"	1.691"	2.182"	1.885"
	26 ft	Lbs./Lf.	40	43	55	59	90	97	128	133
		Deflection	1.724"	1.503"	1.913"	1.663"	2.273"	1.981"	2.565"	2.214"
	28 ft	Lbs./Lf.	34	37	48	51	78	83	110	114
		Deflection	1.971"	1.739"	2.246"	1.933"	2.649"	2.281"	2.965"	2.552"
30 ft	Lbs./Lf.	30	32	41	44	68	73	96	100	
	Deflection	2.291"	1.982"	2.528"	2.198"	3.044"	2.643"	3.409"	2.950"	

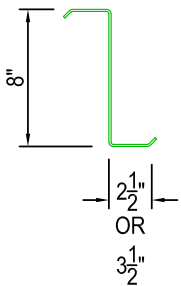
8" ZEE		3 or More Spans, Std. Lap								
		16 Gauge		14 Gauge		12 Gauge		10 Gauge		
Section	Bay		2 1/2" Fl.	3 1/2" Fl.	2 1/2" Fl.	3 1/2" Fl.	2 1/2" Fl.	3 1/2" Fl.	2 1/2" Fl.	3 1/2" Fl.
	12 ft	Lbs./Lf.	309	326	428	456	694	745	982	1020
		Deflection	.299"	.256"	.334"	.288"	.393"	.341"	.441"	.381"
	14 ft	Lbs./Lf.	226	240	312	333	507	545	718	745
		Deflection	.408"	.351"	.454"	.393"	.536"	.466"	.602"	.519"
	16 ft	Lbs./Lf.	172	183	238	254	387	415	547	568
		Deflection	.533"	.460"	.595"	.514"	.702"	.609"	.788"	.679"
	18 ft	Lbs./Lf.	132	140	182	194	296	306	419	435
		Deflection	.658"	.566"	.732"	.632"	.865"	.729"	.971"	.838"
	20 ft	Lbs./Lf.	104	111	144	154	234	251	331	344
		Deflection	.792"	.687"	.887"	.768"	1.046"	.908"	1.174"	1.014"
	22 ft	Lbs./Lf.	84	90	117	124	190	204	268	279
		Deflection	.941"	.818"	1.058"	.909"	1.248"	1.084"	1.397"	1.208"
	24 ft	Lbs./Lf.	70	74	96	103	157	168	222	230
		Deflection	1.115"	.955"	1.234"	1.073"	1.465"	1.268"	1.644"	1.415"
	26 ft	Lbs./Lf.	58	62	81	86	132	141	186	194
		Deflection	1.275"	1.106"	1.437"	1.237"	1.701"	1.470"	1.902"	1.648"
	28 ft	Lbs./Lf.	50	53	69	74	112	120	159	165
		Deflection	1.482"	1.274"	1.651"	1.435"	1.945"	1.686"	2.191"	1.889"
30 ft	Lbs./Lf.	43	46	59	63	97	104	137	142	
	Deflection	1.683"	1.460"	1.864"	1.613"	2.225"	1.930"	2.493"	2.147"	

Notes: 1. The weight of the section has not been subtracted from these values. 2. Both flanges of member must be fully braced. 3. These loads are based on the transfer of the support loads directly to the web of the section by the use of clips or plates. For flanges bearing directly on structural, contact factory for section selection. 4. Loads shown are based on 55 KSI yield strength steel. 5. Loads shown are stress governing. When deflection limits are specified, contact factory. 6. These sample calculations are very basic. Many different variables can affect loading. For instance; drift loading, building height, geographic location, etc. Please consult Flexospan if special conditions exist. 7. The selection of sections for your application is subject to final approval by your design professional. 8. Capacity values have been calculated in accordance with the AISI 2016 design manual. 9. Values shown in the load tables for three or more spans are based on uniform bay spacings. If non-uniform bay spacings exist, contact factory.

FLEXOSPAN STANDARD LOAD TABLE FOR 10" ZEEES

Allowable uniform loads in Pounds per linear foot

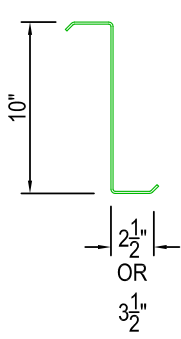
10" ZEE		Simple Span								
Section	Bay		16 Gauge		14 Gauge		12 Gauge		10 Gauge	
			2 1/2" Fl.	3 1/2" Fl.	2 1/2" Fl.	3 1/2" Fl.	2 1/2" Fl.	3 1/2" Fl.	2 1/2" Fl.	3 1/2" Fl.
	20 ft	Lbs./Lf.	86	-	120	127	197	211	278	299
		Deflection	.765"	-	.861"	.749"	1.024"	.900"	1.156"	1.019"
	22 ft	Lbs./Lf.	71	-	99	105	163	174	230	247
		Deflection	.925"	-	1.040"	.907"	1.240"	1.087"	1.400"	1.233"
	24 ft	Lbs./Lf.	59	-	83	88	137	146	193	207
		Deflection	1.089"	-	1.235"	1.076"	1.476"	1.292"	1.664"	1.463"
	26 ft	Lbs./Lf.	51	-	71	75	117	124	164	177
		Deflection	1.296"	-	1.455"	1.263"	1.737"	1.511"	1.948"	1.723"
	28 ft	Lbs./Lf.	44	-	61	65	100	107	142	152
		Deflection	1.504"	-	1.681"	1.473"	1.997"	1.754"	2.268"	1.991"
	30 ft	Lbs./Lf.	38	-	53	56	87	93	123	132
		Deflection	1.712"	-	1.925"	1.672"	2.289"	2.009"	2.589"	2.278"
	32 ft	Lbs./Lf.	33	-	47	49	77	82	108	116
		Deflection	1.924"	-	2.210"	1.894"	2.623"	2.293"	2.943"	2.592"
	34 ft	Lbs./Lf.	29	-	41	44	68	73	96	103
		Deflection	2.155"	-	2.457"	2.167"	2.952"	2.601"	3.334"	2.933"
	36 ft	Lbs./Lf.	26	-	37	39	60	65	85	92
		Deflection	2.428"	-	2.786"	2.415"	3.273"	2.911"	3.711"	3.292"
38 ft	Lbs./Lf.	23	-	33	35	54	58	77	82	
	Deflection	2.667"	-	3.085"	2.690"	3.657"	3.225"	4.173"	3.643"	

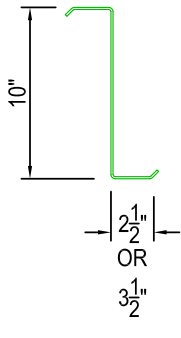
10" ZEE		3 or More Spans, Std. Lap								
Section	Bay		16 Gauge		14 Gauge		12 Gauge		10 Gauge	
			2 1/2" Fl.	3 1/2" Fl.	2 1/2" Fl.	3 1/2" Fl.	2 1/2" Fl.	3 1/2" Fl.	2 1/2" Fl.	3 1/2" Fl.
	20 ft	Lbs./Lf.	131	-	184	195	302	322	426	457
		Deflection	.589"	-	.667"	.582"	.794"	.695"	.896"	.788"
	22 ft	Lbs./Lf.	107	-	149	158	245	260	345	370
		Deflection	.707"	-	.794"	.692"	.946"	.824"	1.066"	.937"
	24 ft	Lbs./Lf.	88	-	123	131	202	216	285	306
		Deflection	.826"	-	.931"	.815"	1.108"	.973"	1.251"	1.101"
	26 ft	Lbs./Lf.	74	-	103	109	169	181	240	256
		Deflection	.963"	-	1.077"	.942"	1.285"	1.128"	1.455"	1.272"
	28 ft	Lbs./Lf.	63	-	88	93	144	154	204	219
		Deflection	1.106"	-	1.241"	1.084"	1.477"	1.294"	1.668"	1.467"
	30 ft	Lbs./Lf.	54	-	76	80	124	132	176	188
		Deflection	1.253"	-	1.416"	1.233"	1.681"	1.465"	1.900"	1.663"
	32 ft	Lbs./Lf.	47	-	66	70	108	116	153	165
		Deflection	1.415"	-	1.594"	1.400"	1.900"	1.670"	2.142"	1.893"
	34 ft	Lbs./Lf.	41	-	58	61	94	102	135	145
		Deflection	1.577"	-	1.789"	1.559"	2.113"	1.876"	2.413"	2.123"
	36 ft	Lbs./Lf.	36	-	51	54	84	90	119	128
		Deflection	1.744"	-	1.980"	1.740"	2.378"	2.084"	2.677"	2.359"
38 ft	Lbs./Lf.	32	-	46	48	75	80	106	114	
	Deflection	1.929"	-	2.220"	1.925"	2.642"	2.304"	2.965"	2.622"	

Notes: 1. The weight of the section has not been subtracted from these values. 2. Both flanges of member must be fully braced. 3. These loads are based on the transfer of the support loads directly to the web of the section by the use of clips or plates. For flanges bearing directly on structural, contact factory for section selection. 4. Loads shown are based on 55 KSI yield strength steel. 5. Loads shown are stress governing. When deflection limits are specified, contact factory. 6. These sample calculations are very basic. Many different variables can affect loading. For instance; drift loading, building height, geographic location, etc. Please consult Flexospan if special conditions exist. 7. The selection of sections for your application is subject to final approval by your design professional. 8. Capacity values have been calculated in accordance with the AISI 2016 design manual. 9. Values shown in the load tables for three or more spans are based on uniform bay spacings. If non-uniform bay spacings exist, contact factory.

FLEXOSPAN STANDARD LOAD TABLE FOR 12" ZEEES

Allowable uniform loads in Pounds per linear foot

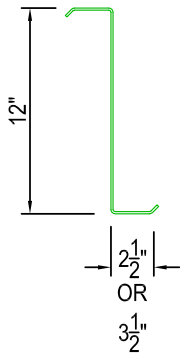
12" ZEE		Simple Span								
		16 Gauge		14 Gauge		12 Gauge		10 Gauge		
Section	Bay		2 1/2" Fl.	3 1/2" Fl.	2 1/2" Fl.	3 1/2" Fl.	2 1/2" Fl.	3 1/2" Fl.	2 1/2" Fl.	3 1/2" Fl.
	20 ft	Lbs./Lf.	-	-	145	155	241	258	344	368
		Deflection	-	-	.670"	.597"	.806"	.717"	.919"	.816"
	22 ft	Lbs./Lf.	-	-	119	128	199	213	284	304
		Deflection	-	-	.806"	.721"	.974"	.867"	1.111"	.987"
	24 ft	Lbs./Lf.	-	-	100	107	167	179	238	255
		Deflection	-	-	.959"	.854"	1.158"	1.032"	1.319"	1.173"
	26 ft	Lbs./Lf.	-	-	85	91	143	152	203	218
		Deflection	-	-	1.122"	1.000"	1.366"	1.207"	1.549"	1.381"
	28 ft	Lbs./Lf.	-	-	74	79	123	131	175	188
		Deflection	-	-	1.314"	1.168"	1.580"	1.399"	1.796"	1.602"
	30 ft	Lbs./Lf.	-	-	64	68	107	114	152	163
		Deflection	-	-	1.498"	1.325"	1.812"	1.605"	2.056"	1.831"
	32 ft	Lbs./Lf.	-	-	56	60	94	100	134	143
		Deflection	-	-	1.697"	1.513"	2.060"	1.822"	2.346"	2.079"
	34 ft	Lbs./Lf.	-	-	50	53	83	89	118	127
		Deflection	-	-	1.931"	1.704"	2.318"	2.067"	2.633"	2.353"
	36 ft	Lbs./Lf.	-	-	44	47	74	79	106	113
		Deflection	-	-	2.136"	1.899"	2.598"	2.306"	2.973"	2.632"
	38 ft	Lbs./Lf.	-	-	40	42	66	71	95	102
		Deflection	-	-	2.410"	2.107"	2.877"	2.573"	3.308"	2.949"
40 ft	Lbs./Lf.	-	-	36	38	60	64	86	92	
	Deflection	-	-	2.663"	2.340"	3.211"	2.847"	3.677"	3.266"	

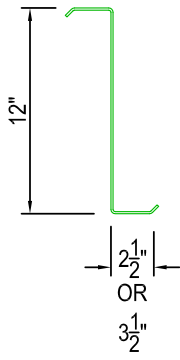
12" ZEE		3 or More Spans, Std. Lap								
		16 Gauge		14 Gauge		12 Gauge		10 Gauge		
Section	Bay		2 1/2" Fl.	3 1/2" Fl.	2 1/2" Fl.	3 1/2" Fl.	2 1/2" Fl.	3 1/2" Fl.	2 1/2" Fl.	3 1/2" Fl.
	20 ft	Lbs./Lf.	-	-	209	220	369	394	525	563
		Deflection	-	-	.490"	.428"	.625"	.554"	.709"	.632"
	22 ft	Lbs./Lf.	-	-	178	188	299	320	426	456
		Deflection	-	-	.613"	.538"	.744"	.661"	.846"	.751"
	24 ft	Lbs./Lf.	-	-	148	158	247	264	352	377
		Deflection	-	-	.725"	.642"	.873"	.775"	0.993	.883"
	26 ft	Lbs./Lf.	-	-	124	133	208	222	296	317
		Deflection	-	-	.839"	.746"	1.016"	.900"	1.153"	1.025"
	28 ft	Lbs./Lf.	-	-	106	113	177	189	252	270
		Deflection	-	-	.968"	.855"	1.165"	1.033"	1.323"	1.177"
	30 ft	Lbs./Lf.	-	-	91	98	152	163	217	233
		Deflection	-	-	1.098"	.979"	1.322"	1.176"	1.504"	1.341"
	32 ft	Lbs./Lf.	-	-	79	85	132	142	189	203
		Deflection	-	-	1.238"	1.102"	1.489"	1.329"	1.699"	1.515"
	34 ft	Lbs./Lf.	-	-	69	75	117	125	166	178
		Deflection	-	-	1.381"	1.241"	1.686"	1.493"	1.905"	1.695"
	36 ft	Lbs./Lf.	-	-	61	66	103	110	148	158
		Deflection	-	-	1.539"	1.375"	1.869"	1.654"	2.138"	1.894"
	38 ft	Lbs./Lf.	-	-	55	59	92	99	132	141
		Deflection	-	-	1.726"	1.528"	2.075"	2.851"	2.370"	2.101"
40 ft	Lbs./Lf.	-	-	49	53	82	88	118	127	
	Deflection	-	-	1.893"	1.687"	2.275"	2.022"	2.604"	2.326"	

Notes: 1. The weight of the section has not been subtracted from these values. 2. Both flanges of member must be fully braced. 3. These loads are based on the transfer of the support loads directly to the web of the section by the use of clips or plates. For flanges bearing directly on structural, contact factory for section selection. 4. Loads shown are based on 55 KSI yield strength steel. 5. Loads shown are stress governing. When deflection limits are specified, contact factory. 6. These sample calculations are very basic. Many different variables can affect loading. For instance; drift loading, building height, geographic location, etc. Please consult Flexospan if special conditions exist. 7. The selection of sections for your application is subject to final approval by your design professional. 8. Capacity values have been calculated in accordance with the AISI 2016 design manual. 9. Values shown in the load tables for three or more spans are based on uniform bay spacings. If non-uniform bay spacings exist, contact factory.

FLEXOSPAN STANDARD LOAD TABLE FOR 14" ZEEES

Allowable uniform loads in Pounds per linear foot

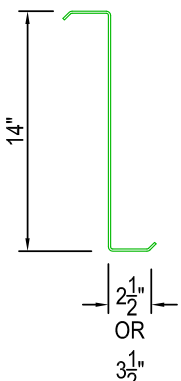
14" ZEE		Simple Span								
Section	Bay	16 Gauge		14 Gauge		12 Gauge		10 Gauge		
		2 1/2" Fl.	3 1/2" Fl.	2 1/2" Fl.	3 1/2" Fl.	2 1/2" Fl.	3 1/2" Fl.	2 1/2" Fl.	3 1/2" Fl.	
	22 ft	Lbs./Lf.	-	-	139	150	234	251	336	362
		Deflection	-	-	.646"	.586"	.785"	.708"	.900"	.814"
	24 ft	Lbs./Lf.	-	-	116	126	197	211	283	304
		Deflection	-	-	.763"	.697"	.936"	.843"	1.073"	.968"
	26 ft	Lbs./Lf.	-	-	99	107	167	180	241	259
		Deflection	-	-	.897"	.816"	1.093"	.990"	1.259"	1.136"
	28 ft	Lbs./Lf.	-	-	85	92	144	155	207	223
		Deflection	-	-	1.036"	.943"	1.268"	1.147"	1.454"	1.316"
	30 ft	Lbs./Lf.	-	-	74	80	126	135	181	194
		Deflection	-	-	1.188"	1.081"	1.462"	1.317"	1.676"	1.508"
	32 ft	Lbs./Lf.	-	-	65	70	110	119	159	170
		Deflection	-	-	1.351"	1.225"	1.652"	1.502"	1.906"	1.711"
	34 ft	Lbs./Lf.	-	-	58	62	98	105	141	151
		Deflection	-	-	1.537"	1.382"	1.876"	1.689"	2.154"	1.937"
	36 ft	Lbs./Lf.	-	-	51	55	87	94	125	135
		Deflection	-	-	1.698"	1.541"	2.093"	1.901"	2.400"	2.176"
	38 ft	Lbs./Lf.	-	-	46	50	78	84	112	121
		Deflection	-	-	1.902"	1.740"	2.330"	2.109"	2.670"	2.422"
	40 ft	Lbs./Lf.	-	-	42	45	70	76	101	109
		Deflection	-	-	2.132"	1.922"	2.567"	2.343"	2.956"	2.678"
42 ft	Lbs./Lf.	-	-	38	41	64	69	92	99	
	Deflection	-	-	2.344"	2.129"	2.853"	2.585"	3.272"	2.957"	

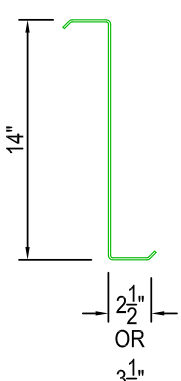
14" ZEE		3 or More Spans, Std. Lap								
Section	Bay	16 Gauge		14 Gauge		12 Gauge		10 Gauge		
		2 1/2" Fl.	3 1/2" Fl.	2 1/2" Fl.	3 1/2" Fl.	2 1/2" Fl.	3 1/2" Fl.	2 1/2" Fl.	3 1/2" Fl.	
	22 ft	Lbs./Lf.	-	-	177	182	351	377	505	543
		Deflection	-	-	.417"	.361"	.598"	.540"	.686"	.619"
	24 ft	Lbs./Lf.	-	-	154	160	290	312	418	448
		Deflection	-	-	.516"	.451"	.701"	.634"	.807"	.726"
	26 ft	Lbs./Lf.	-	-	136	141	244	262	351	377
		Deflection	-	-	.629"	.549"	.815"	.736"	.936"	.844"
	28 ft	Lbs./Lf.	-	-	120	125	208	223	299	322
		Deflection	-	-	.748"	.656"	.936"	.844"	1.074"	.971"
	30 ft	Lbs./Lf.	-	-	106	112	179	193	258	277
		Deflection	-	-	.872"	.776"	1.064"	.964"	1.224"	1.104"
	32 ft	Lbs./Lf.	-	-	92	100	156	168	225	242
		Deflection	-	-	.982"	.898"	1.203"	1.089"	1.384"	1.250"
	34 ft	Lbs./Lf.	-	-	81	88	137	148	197	212
		Deflection	-	-	1.103"	1.009"	1.348"	1.224"	1.547"	1.398"
	36 ft	Lbs./Lf.	-	-	72	78	122	131	174	188
		Deflection	-	-	1.234"	1.125"	1.511"	1.364"	1.720"	1.560"
	38 ft	Lbs./Lf.	-	-	64	69	108	117	155	168
		Deflection	-	-	1.364"	1.238"	1.663"	1.514"	1.905"	1.733"
	40 ft	Lbs./Lf.	-	-	58	62	97	105	140	150
		Deflection	-	-	1.519"	1.367"	1.836"	1.670"	2.115"	1.902"
42 ft	Lbs./Lf.	-	-	52	56	88	94	126	136	
	Deflection	-	-	1.658"	1.502"	2.027"	1.820"	2.316"	2.099"	

Notes: 1. The weight of the section has not been subtracted from these values. 2. Both flanges of member must be fully braced. 3. These loads are based on the transfer of the support loads directly to the web of the section by the use of clips or plates. For flanges bearing directly on structural, contact factory for section selection. 4. Loads shown are based on 55 KSI yield strength steel. 5. Loads shown are stress governing. When deflection limits are specified, contact factory. 6. These sample calculations are very basic. Many different variables can affect loading. For instance; drift loading, building height, geographic location, etc. Please consult Flexospan if special conditions exist. 7. The selection of sections for your application is subject to final approval by your design professional. 8. Capacity values have been calculated in accordance with the AISI 2016 design manual. 9. Values shown in the load tables for three or more spans are based on uniform bay spacings. If non-uniform bay spacings exist, contact factory.



Number one priority at FLEXOSPAN is customer satisfaction! Our large inventory of galvanized, stainless steel, Zam® and primed painted steel in various gauges enables us to produce and ship orders quickly. Call us at 800-245-0396, and let us help your next project run smoothly by providing quality, cost effective components.

FLEXOSPAN'S easy access to major interstate highways makes for convenient delivery or customer pick up.