

Notice of Addendum #02 - 3/13/2025

PROJECT: **New Training Facility**
St. Tammany Fire Protection District No. 1
34780 S Range Road
Slidell, La. 70460

PROJECT NO.: **2507**

FROM: **DAMMON ENGINEERING**
554 Old Spanish Trail
Slidell, LA 70458
(985) 649-5832

TO: All on Record Holding Bidding Documents

This Addendum forms a part of the Contract Documents and modifies the original Bidding Documents dated 2-10-2025. The contents of this Addendum shall be included in the Contract Documents when the Agreement is executed. Changes made by this Addendum take precedence over the Documents of earlier date.

Acknowledge receipt of this Addendum in the space provided on the Bid Form.

GENERAL

1. The addendum is to be distributed to registered Plan Holders via email.

General Questions

The following questions were submitted. Answers are in bold.

1. What is the manufacturer and model of the flooring?
The basis of design for the flooring is 6" Milestone Planks manufactured by Pier, Santa Monica #8700614
Contractor shall provide samples prior to installation.
2. What is the manufacturer and model of the restroom wall tile?
The basis of design for the flooring and wall tile
Pier, Santa Monica #8700614 (Flooring)
3x8 Wall Tile to compliment flooring (Bathroom)
Contractor shall provide samples prior to installation.

3. The new energy code, IECC 2021 was adopted in Louisiana this year; must the metal building be constructed to meet this new code?

Yes, the metal building shall be constructed to meet the requirements of IECC 2021.IECC 2021 Tbl C402.1.3: Wind load of 140 mph.

- a. The roof shall have R-11 Liner System (LS).
 - b. The walls shall have R-13 + R-13 continuous insulation (ci)
 - c. The drop ceilings shall have R-19 insulation.
4. How much fill is needed?
A. See the attached fill plan drawing.
5. Will a water distribution drawing be provided?
A. **No. Tie into the existing 2" water line with a new 2" water line and 2" ball valve to the side of the new bldg. from there all water lines will be per the attached plumbing schedule. See the attached two pdf's for reference.**
6. Prior approval lighting request.
A. Sesco Lighting
B. WKA Lighting

THE ADDENDUM No. 02 CONSISTS OF:

Addendum Cover and Narrative (2 pages), Pre-Bid Sign-In sheet (2 pages), Sesco Lighting substitution request (36 pages), WKA Lighting Substitution request (44 pages), Fill plan drawing, domestic water line drawing and plumbing schedule (3).

For a total of [87] DOCUMENT SHEETS

All plan holders must acknowledge receipt of this addendum via reply email.

DAMMON

ENGINEERING, INC.

Architects & Engineers

554 Old Spanish Trail
 Slidell, LA 70458
 Phone: 985-649-5832
 dammonengineering.com
 info@dammonengineering.com

Sign-In Sheet

New Training Facility
 St. Tammany Fire Protection District No. 1
 34780 S Range Road
 Slidell, La. 70460

Pre-Bid Conference - 03-10-25 10 am

Name	Company	Address	Phone	Email
Chuck Dammon	Dammon Engineering	554 Old Spanish Trail	649-5832	Chuck@dammonengineering.com

David Siben	Betco	PO Box 5658	514 609-9763	dsiben@betco.com
Brandon Scully	Korts	2182 Martin Dr Covington 70124	985-898-0952	Byronetalbot, con bscully@korts. constructionservices.com
Beau Smith	Construction	6138 Vicksburg St Lafayette 70508	504 452 6170	beau@lcdnola.com
TUCKER FAUST	CONSTRUCTION	278 GENERAL PATTON AVE. Lafayette 70508	985-502-4641	INFO@SIEVERDING CONSTRUCTION.COM
Jai Boudreaux	Kelly Construction Group	1618 Myrtle St P.O. Box 5596 Slidell, LA 70460	225-293-4949 985-882-2426	Bids@kellyconstructiongroup.com
MIKE BERKOWITZ	SMITH CONSTRUCTION CO.	Slidell, LA 70460		mike@smithcc.net
MIKE NATAL	M NATAL CONTRACTOR	547 Vicks Rd. Slidell, La. 70461	985-960-1478	mike@mnatal.com cheri@mnatal.com
Tim Palmer	Spartan Building Corporation	251 LA 21 Madisonville Lafayette 70508	985 645 2555	Bids@SpartanBuildingCo.com
Bradley Boulton	Redox		985-590-8785	Brad@Redoxconstruction.com
Bradley Boulton	Redox		985-502-1910	Red@redoxconstruction.com
Kirk Foster	Shamrock Construction Co.		225-478-2026	Bids@shamrockcc.com
Walt Kincaid	Kincaid Tractor Service	3939 W. Causeway Blvd Ste 205 Metairie, LA 70002	985 507 1604	Kincaidtractor@prod
Stephen LeBlanc	Pillar		945 201-5011	stephen@pillarbuilds.com

DAMMON ENGINEERING, INC.

Architects & Engineers

554 Old Spanish Trail
Slidell, LA 70458
Phone: 985-649-5832
dammonengineering.com
info@dammonengineering.com

Sign-In Sheet

New Training Facility
St. Tammany Fire Protection District No. 1
34780 S Range Road
Slidell, La. 70460

Pre-Bid Conference - 03-10-25 10 am

Name	Company	Address	Phone	Email
Chuck Dammon	Dammon Engineering	554 Old Spanish Trail	649-5832	Chuck@dammonengineering.com
Wes LaBorde	Sage Construction	7427 LA-1 Donaldsonville, LA	(321) 474-0048	wlaborde@sageconstruction.ne

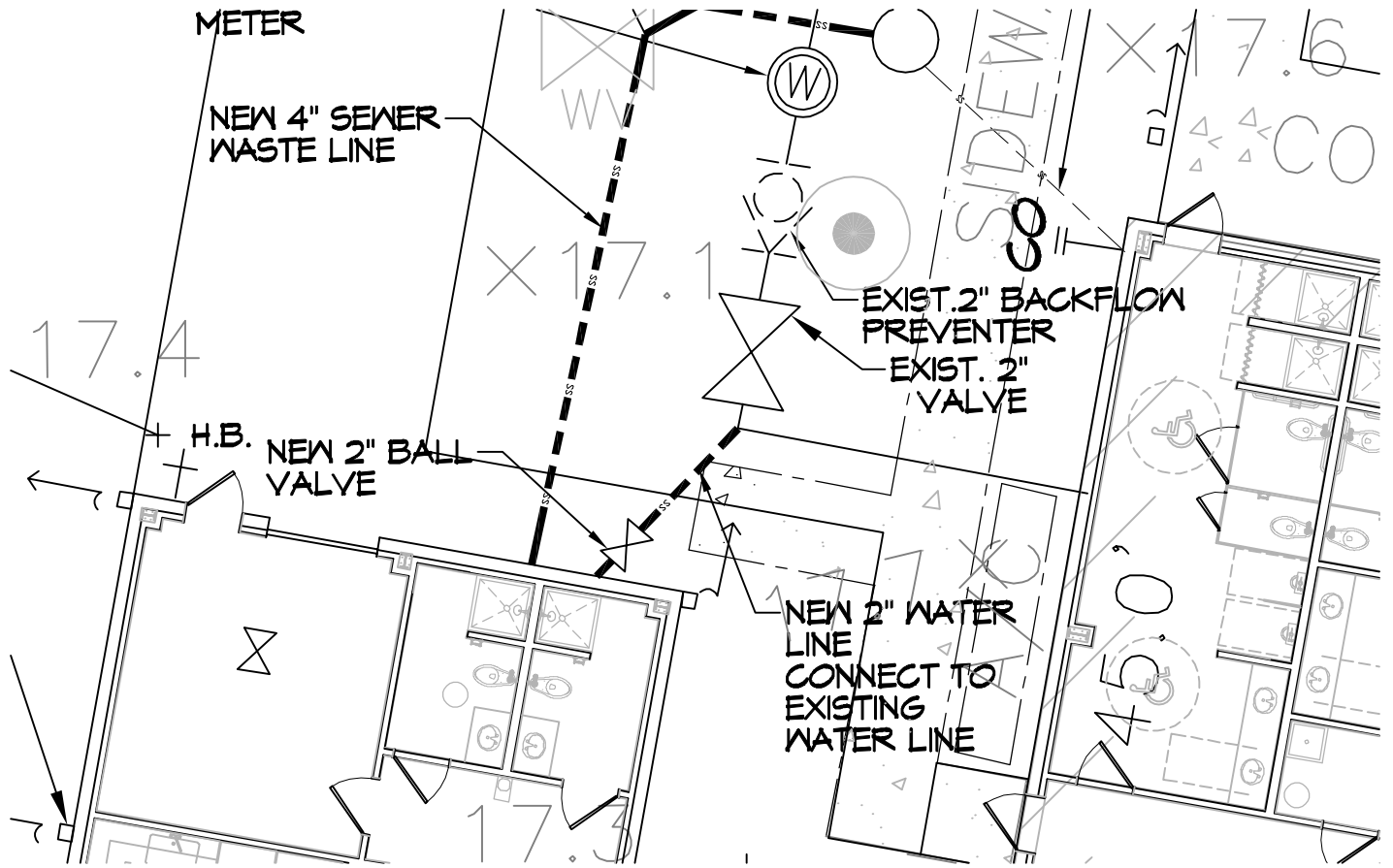

Domestic water line drawing

PLUMBING FIXTURE SCHEDULE

MK	DESCRIPTION	TYPE	ROUGH - IN - SIZE				NOTES
			WASTE	VENT	COLD	HOT	
WC	WATER CLOSET	VALVE	4"	3"	1-1/2"	-	3
UR	URINAL	VALVE	3"	2"	3/4"	-	3
LAV	LAVATORY	WALL HUNG	2"	2"	3/4"	3/4"	1,2,3
SH	SHOWER	-	2"	2"	3/4"	3/4"	5
FD	FLOOR DRAIN	-	3"	2"	-	-	4
HS	HAND SINK	-	3"	2"	3/4"	3/4"	-
MS	MOP SINK	-	3"	2"	3/4"	3/4"	-
WH	WATER HEATER	-	3/4"	2"	3/4"	3/4"	-
AHU	AIR HANDLER DRAIN	-	3/4"	2"	-	-	-

NOTES:

1. INSULATE PIPING FOR HANDICAP FIXTURE.
2. PROVIDE CHAIR CARRIER FOR WALL HUNG FIXTURE.
3. HANDICAP FIXTURE
4. INSTALL CONTINUOUS DRIP VALVE ON ALL FLOOR DRAINS.
5. PROVIDE ASSE 1016 COMPLIANT VALVE - FOR ALL SHOWERS
6. PROVIDE ASSE 1070 COMPLIANT MIXING VALVE - FOR ALL LAVATORIES/SINKS

Plumbing Schedule

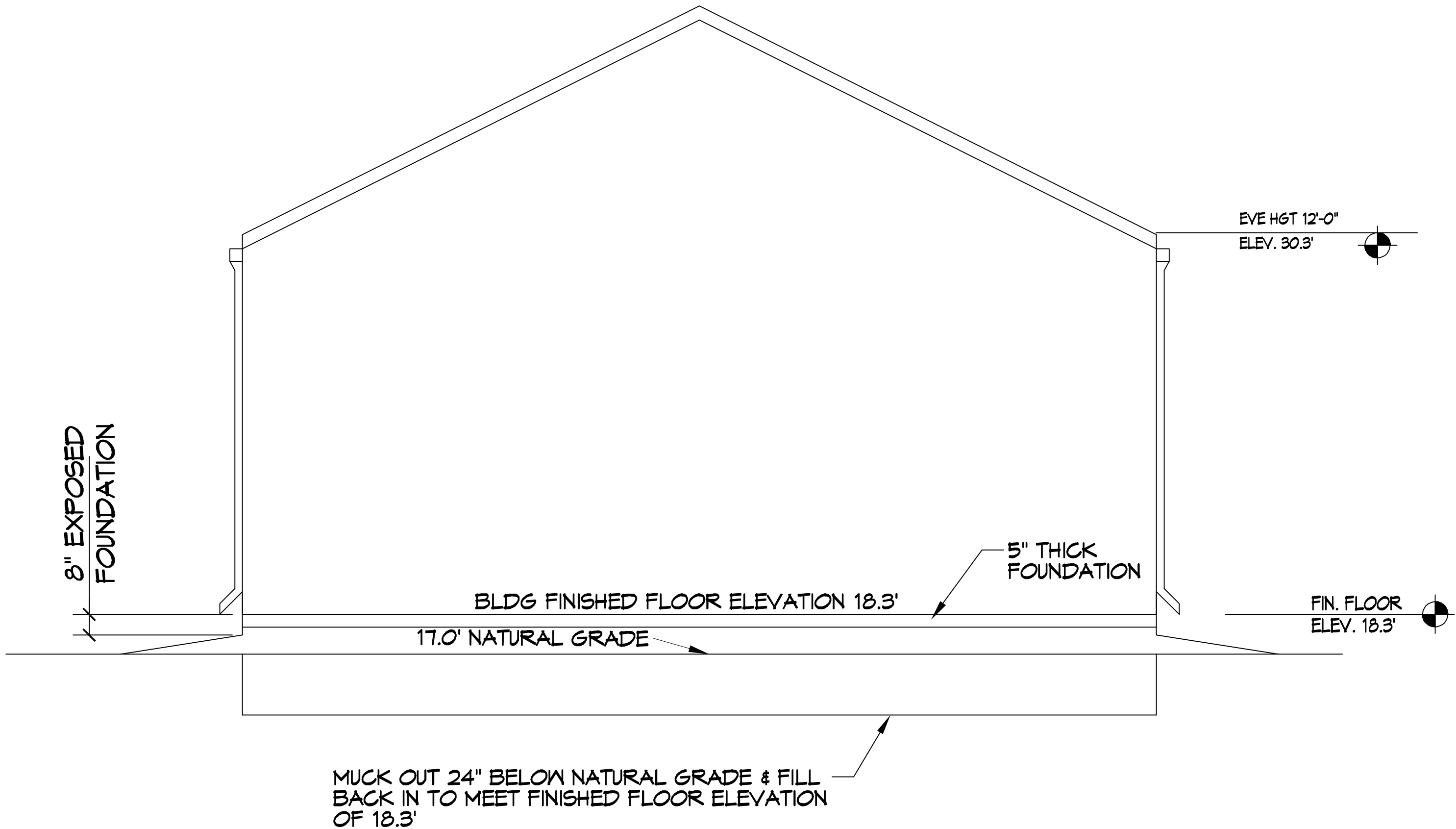

MUCK OUT 24" BELOW NATURAL GRADE & FILL BACK IN TO MEET FINISHED FLOOR ELEVATION OF 18.3'

Fill plan drawing



NEW TRAINING FACILITY ST. TAMMANY FIRE PROTECTION DISTRICT 1



Prepared By

George Neumiller - SESCO - New Orleans

504-326-1400

gneumiller@sescolighting.com

3340 Severn Avenue, Suite 215

Metairie, LA 70002, USA



Table of Contents

Datasheets

New Section			
Type	Manufacturer	Model Number	Pg.
F1	DAY-BRITE	2DSRT4060LCS-4-UNV-DIM	2
F2	DAY-BRITE	2DSRT3050LCS-2-UNV-DIM	7
F2A	DAY-BRITE	2DSRT3050LCS-2-UNV-DIM / FMA22	12
F3	LIGHTOLIER	6RN / P6RDL15930WCLZ10U	17
F4	ASL	TLZD-3	26
EX	CHLORIDE	VERWEM	27
EM	CHLORIDE	VLTUR	29
S1E	STONCO	ASW25-SCT-G1-8-PCB-BW	32



Notes Summary



Datasheets

New Section



Job Name : NEW TRAINING FACILITY ST. TAMMANY FIRE PROTECTION DISTRICT 1
Manufacturer : DAY-BRITE
Model Number : 2DSRT4060LCS-4-UNV-DIM

Type :
F1

Day-Brite

CFI

Recessed

DSRT Selectable Troffer

Selectable lumens & CCT



Day-Brite/CFI DSRT Selectable Troffer is a robust low glare luminaire designed to provide three lumen and three CCT field selectable options per size. Available for use in recessed, suspended and surface mount applications. Ideal for general lighting applications such as open office, schools, healthcare, and retail.

Project: _____
 Location: _____
 Cat. No: _____
 Type: _____
 Qty: _____
 Notes: _____



Ordering guide

Catalog Code	Size	Voltage	Power / Wattage			Lumens ¹			Efficacy		
			3500K	4000K	5000K	3500K	4000K	5000K	3500K	4000K	5000K
1DSRT3050LCS-4-UNV-DIM	1x4	UNV	39	39	39	5000	5150	5000	128	132	128
1DSRT3050LCS-4-UNV-DIM	1x4	UNV	31	31	31	4000	4100	4000	129	132	129
1DSRT3050LCS-4-UNV-DIM	1x4	UNV	23	23	23	2850	2900	2900	124	126	126
2DSRT3050LCS-2-UNV-DIM	2x2	UNV	35	35	35	4350	4500	4400	124	129	126
2DSRT3050LCS-2-UNV-DIM	2x2	UNV	28	28	28	3650	3800	3700	130	136	132
2DSRT3050LCS-2-UNV-DIM	2x2	UNV	22	22	22	2750	2750	2800	125	125	127
2DSRT4060LCS-4-UNV-DIM	2x4	UNV	46	46	46	6000	6150	6100	130	134	133
2DSRT4060LCS-4-UNV-DIM	2x4	UNV	39	39	39	5000	5150	5000	128	132	128
2DSRT4060LCS-4-UNV-DIM	2x4	UNV	30	30	30	4000	4100	4000	133	137	133
1DSRT3050LCS-4-UNV-DIM-DAYOCC	1x4	UNV	39	39	39	5000	5150	5000	128	132	128
1DSRT3050LCS-4-UNV-DIM-DAYOCC	1x4	UNV	31	31	31	4000	4100	4000	129	132	129
1DSRT3050LCS-4-UNV-DIM-DAYOCC	1x4	UNV	23	23	23	2850	2900	2900	124	126	126
2DSRT3050LCS-2-UNV-DIM-DAYOCC	2x2	UNV	35	35	35	4350	4500	4400	124	129	126
2DSRT3050LCS-2-UNV-DIM-DAYOCC	2x2	UNV	28	28	28	3650	3800	3700	130	136	132
2DSRT3050LCS-2-UNV-DIM-DAYOCC	2x2	UNV	22	22	22	2750	2750	2800	125	125	127
2DSRT4060LCS-4-UNV-DIM-DAYOCC	2x4	UNV	46	46	46	6000	6150	6100	130	134	133
2DSRT4060LCS-4-UNV-DIM-DAYOCC	2x4	UNV	39	39	39	5000	5150	5000	128	132	128
2DSRT4060LCS-4-UNV-DIM-DAYOCC	2x4	UNV	30	30	30	4000	4100	4000	133	137	133

1. Nominal delivered lumens at 25°C ambient

Accessories (order separately)

- DBELIS10WKit - 10W Selectable Nano Inverter EM Kit (field installed)
- DSRT-CKT-NP - Selectable Troffer Suspension Kit with no Power
- DSRT-CKT-WP - Selectable Troffer Suspension Kit with Power
- 1DSRT-4-SKT - 1x4' Selectable Troffer Surface Kit
- 2DSRT-2-SKT - 2x2' Selectable Troffer Surface Kit
- 2DSRT-4-SKT - 2x4' Selectable Troffer Surface Kit
- FMA14 - 1'x4' "F" mounting frame for NEMA "F" mounting
- FMA22 - 2'x2' "F" mounting frame for NEMA "F" mounting
- FMA24 - 2'x4' "F" mounting frame for NEMA "F" mounting

Not all product variations listed on page are DLC qualified. To ensure that a specific model is qualified, visit www.designlights.org/search





DSRT Selectable Troffer

Selectable lumens & CCT

Application

- Overall 2.76in deep luminaire, including driver box
- Even distribution of light on the lens provide very low glare
- General light distribution creates uniform horizontal and vertical illuminance
- CRI 80 minimum colour rendering with balanced spectrum
- Accessory field install kits available for surface mounting

Field Selectable CCT and Wattage

- CCT can easily be selected in the field between 5000K (CW); 4000K (NW); 3500K (WW).
- Wattage selection allows for easy field selection between three lumen packages (see performance chart for details).
- Factory default settings noted in image below:

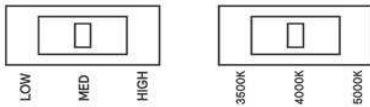

Enclosure

- Polystyrene diffuser provides visual comfort and high efficiency
- Lens is easy to detach for cleaning
- Opal lens provides a uniform aesthetic on the ceiling plane
- Tight enclosure assembly impedes ingress of dust and insects

Electrical

- Up to 125 lm/W efficacy
- Driver featuring high power factor (>0.90), 120-277V 60/50Hz, and less than 25% THD
- Operating temperature -10°C-40°C
- Standard configurations are 0-10V dimming to 1%
- 50,000 hours @ L70B50
- cETLus listed to ETL and CSA standards, suitable for damp locations
- IC rated
- DSRT Selectable Troffer luminaires are Designlights Consortium® Premium qualified.
- Please see the DLC QPL list for exact catalogue numbers www.designlights.org/QPL

Construction/Finish

- Strong and well constructed 3in deep 5VA housing
- Die formed driver box with standard access plate for ease of wiring
- Integral clips accommodate definitive attachment to T-bar grid for recessed applications

Sensor

- DAYOCC sensor options available with 3 control settings (Occupancy, Daylighting & Dimming)
- Sensor provides five coverage patterns to ensure accuracy

General Notes

- All accessories are field installed.
- All options are factory installed.
- Many luminaire components, such as reflectors, refractors, lenses, sockets, lampholders, and LEDs are made from various types of plastics which can be adversely affected by airborne contaminants. If sulfur based chemicals, petroleum based products, cleaning solutions, or other contaminants are expected in the intended area of use, consult factory for compatibility.
- Five year limited luminaire warranty includes LED boards and driver. Visit www.signify.com/warranties for complete warranty information.

Sensor Features

1. Sensor/0-10V Dim = Enable or Disable Sensor (Default: Enabled)
2. CCT Selector = Choose between 3500K, 4000K or 5000K (Default: 4000K)
3. Power Selector = Choose between Low, Mid or High (Default: High)

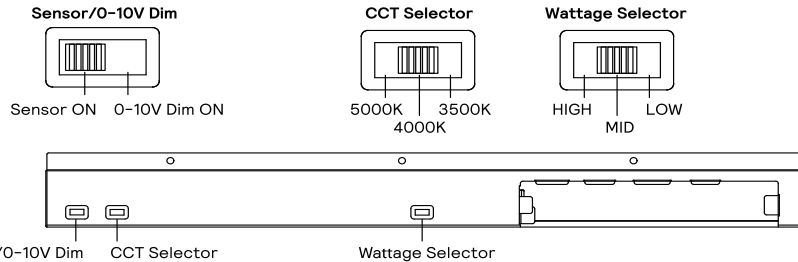

Sensor control settings

Occupied timeout
Switches 1, 2, & 3
Default = 10 seconds

ON ↑
OFF ↓

Time: 1, 2, 3

Time	1	2	3
10 sec	↓	↓	↓
30 sec	↓	↓	↑
1 min	↓	↑	↓
3 min	↓	↑	↑
5 min	↑	↓	↓
10 min	↑	↓	↑
15 min	↑	↑	↓
30 min	↑	↑	↑

Stand-by dimming level
Switch 4
Default = 20% dimming

ON ↑
OFF ↓

Stand-by level: 4

↑ 50%
↓ 20%

Stand-by timing level
Switches 5 & 6
Default = 1 minute

ON ↑
OFF ↓

Stand-by L-times: 5, 6

Time	5	6
1 min	↓	↓
30 min	↓	↑
60 min	↑	↓
+∞	↑	↑



DSRT Selectable Troffer

Selectable lumens & CCT

Standard Configurations

2x2 dimensions

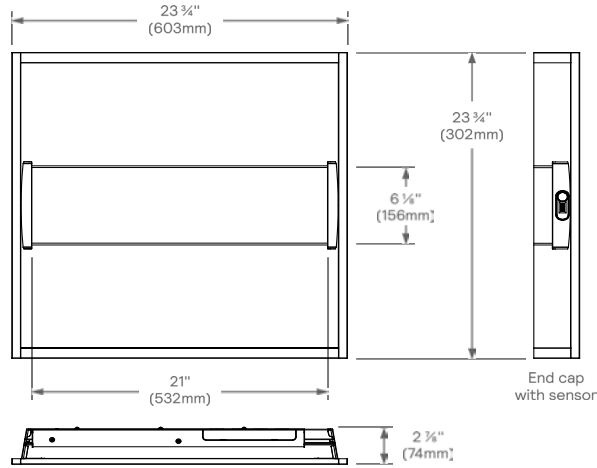

1x4 dimensions

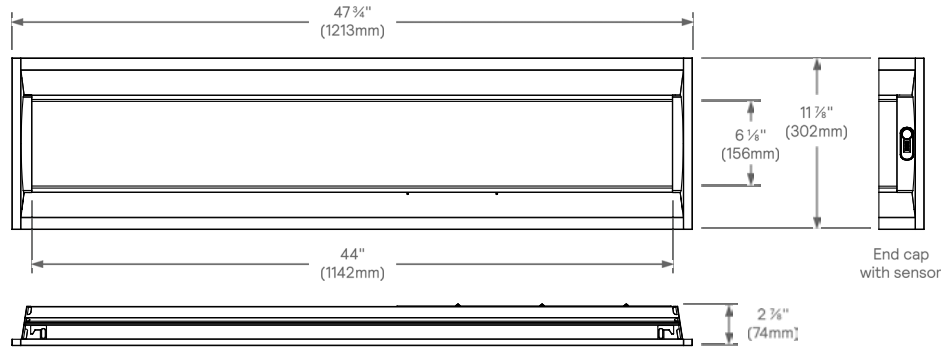

2x4 dimensions

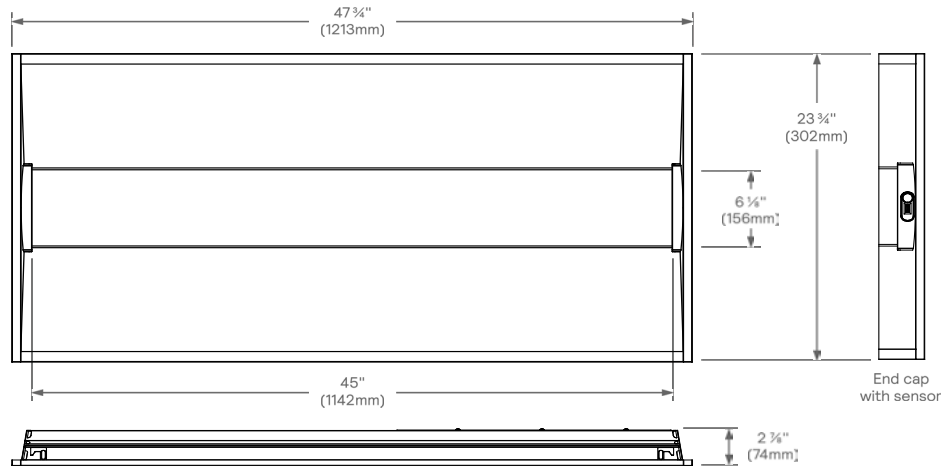



DSRT Selectable Troffer

Selectable lumens & CCT

Photometry

1DSRT3050LCS-4-UNV-DIM H

Luminaire Lumens 5000
Luminaire Efficacy Rating (LER) 132
Total Luminaire Watts 38
Spacing Criterion (0-180) 1.28

Candela Distribution						Flux
	0	22.5	45	67.5	90	Lumens
0	1674	1674	1674	1674	1674	
5	1667	1667	1667	1667	1667	159
15	1608	1608	1608	1608	1607	454
25	1488	1488	1487	1487	1487	684
35	1304	1304	1304	1304	1304	815
45	1057	1057	1057	1057	1057	822
55	737	739	741	745	749	703
65	399	403	408	420	432	500
75	155	160	165	178	191	294
85	26	27	28	33	37	69
90	0	0	0	0	1	

Zonal Lumen Summary			
Zone	Lumens	%Fixture	%Lamp
0-30	1439	28.8%	28.8%
0-40	2356	47.1%	47.1%
0-60	4108	82.2%	82.2%
0-90	5000	100.0%	100.0%
0-180	4721	100.00%	100.00%

Average Luminance (cd/m ²)			
	0	90	180
45	4785	4703	4584
55	4327	4359	4296
65	3422	3884	3631
75	2330	2845	2180
85	1233	1380	1067

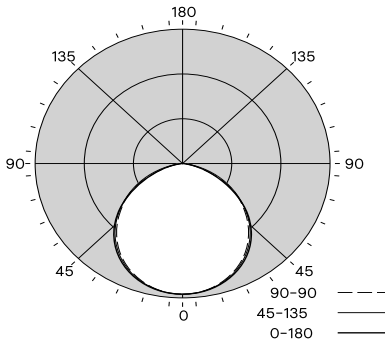

Coefficients of Utilization %												
Pc---	80				70			50		0		
Pw---	70	50	30	10	70	50	30	50	30	10	0	
RCR	0	119	119	119	119	116	116	116	111	111	111	100
	1	109	105	101	97	107	103	99	98	95	93	85
	2	100	92	86	80	97	90	84	87	82	77	72
	3	91	81	73	67	89	80	72	77	70	65	61
	4	84	72	64	57	81	71	63	68	61	56	52
	5	77	64	56	49	75	63	55	61	54	48	45
	6	71	58	49	43	69	57	49	55	48	42	40
	7	66	53	44	38	64	52	44	50	43	38	35
	8	61	48	40	34	60	47	39	46	39	34	31
	9	57	44	36	31	56	44	36	42	35	30	28
	10	54	41	33	28	53	40	33	39	32	28	26

2DSRT3050LCS-2-UNV-DIM H

Luminaire Lumens 4095
Luminaire Efficacy Rating (LER) 125
Total Luminaire Watts 32.8
Spacing Criterion (0-180) 1.27

Candela Distribution						Flux
	0	22.5	45	67.5	90	Lumens
0	1674	1674	1674	1674	1674	
5	1667	1667	1667	1667	1667	159
15	1608	1608	1608	1608	1607	454
25	1488	1488	1487	1487	1487	684
35	1304	1304	1304	1304	1304	815
45	1057	1057	1057	1057	1057	822
55	737	739	741	745	749	703
65	399	403	408	420	432	500
75	155	160	165	178	191	294
85	26	27	28	33	37	69
90	0	0	0	0	1	

Zonal Lumen Summary			
Zone	Lumens	%Fixture	%Lamp
0-30	1296	28.8%	28.8%
0-40	2111	46.9%	46.9%
0-60	3635	80.8%	80.8%
0-90	4500	100.0%	100.0%
0-180	4095	100.00%	100.00%

Average Luminance (cd/m ²)			
	0	90	180
45	4100	4130	4190
55	3526	3771	3966
65	2589	3324	3785
75	1645	3031	3980
85	804	1907	1600

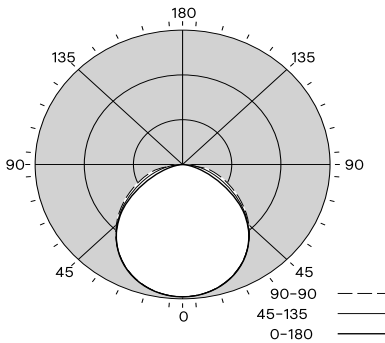

Coefficients of Utilization %												
Pc---	80				70			50		0		
Pw---	70	50	30	10	70	50	30	50	30	10	0	
RCR	0	119	119	119	119	116	116	116	111	111	111	100
	1	110	106	102	98	107	103	100	99	96	94	86
	2	101	93	87	81	98	91	85	88	83	79	73
	3	92	82	75	69	90	81	74	78	72	67	62
	4	85	73	65	59	82	72	64	70	63	57	54
	5	78	66	57	51	76	65	57	63	55	50	47
	6	72	59	51	45	70	58	50	57	49	44	41
	7	67	54	46	40	65	53	45	52	44	39	37
	8	62	49	41	35	61	49	41	47	40	35	33
	9	58	45	37	32	57	45	37	44	37	32	30
	10	55	42	34	29	54	41	34	40	34	29	27



Job Name : NEW TRAINING FACILITY ST. TAMMANY FIRE PROTECTION DISTRICT 1
Manufacturer : DAY-BRITE
Model Number : 2DSRT4060LCS-4-UNV-DIM

Type :
F1

DSRT Selectable Troffer

Selectable lumens & CCT

Photometry

2DSRT4060LCS-4-UNV-DIM H

Luminaire Lumens 6000
Luminaire Efficacy Rating (LER) 130
Total Luminaire Watts 46
Spacing Criterion (0-180) 1.28

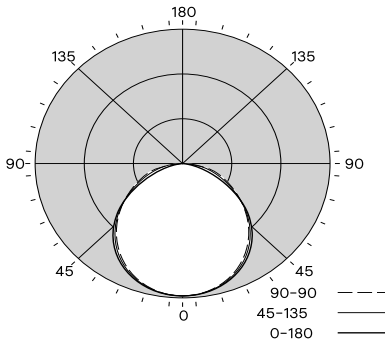

Candela Distribution						Flux
	0	22.5	45	67.5	90	Lumens
0	2168	2168	2168	2168	2168	
5	2159	2159	2159	2159	2159	206
15	2094	2093	2093	2092	2091	589
25	1959	1958	1957	1955	1953	892
35	1748	1747	1746	1742	1739	1070
45	1454	1452	1451	1446	1441	1090
55	1061	1061	1061	1060	1059	948
65	608	613	619	631	644	692
75	244	252	259	278	298	416
85	43	47	51	64	77	97
90	1	1	1	1	1	

Zonal Lumen Summary			
Zone	Lumens	%Fixture	%Lamp
0-30	1685	28.1%	28.1%
0-40	2754	45.9%	45.9%
0-60	4792	79.9%	79.9%
0-90	6000	100.0%	100.0%
0-180	3788	100.00%	100.00%

Average Luminance (cd/m ²)			
	0	90	180
45	5641	5476	5368
55	5076	5075	5076
65	3945	4605	4898
75	2585	4426	5209
85	1337	2733	1624

Coefficients of Utilization %												
Pc---	80				70			50		0		
Pw---	70	50	30	10	70	50	30	50	30	10	0	
RCR	0	119	119	119	119	116	116	116	111	111	111	100
	1	110	105	101	97	107	103	99	99	96	93	85
	2	100	92	86	80	97	90	84	87	82	77	72
	3	91	81	74	67	89	80	73	77	71	65	61
	4	84	72	64	57	82	71	63	68	62	56	52
	5	77	65	56	50	75	64	55	61	54	49	46
	6	71	58	50	43	69	57	49	56	48	43	40
	7	66	53	44	38	64	52	44	51	43	38	35
	8	62	48	40	34	60	48	40	46	39	34	32
	9	58	44	36	31	56	44	36	43	36	31	28
	10	54	41	33	28	53	40	33	39	32	28	26

© 2024 Signify Holding. All rights reserved. The information provided herein is subject to change, without notice. Signify does not give any representation or warranty as to the accuracy or completeness of the information included herein and shall not be liable for any action in reliance thereon. The information presented in this document is not intended as any commercial offer and does not form part of any quotation or contract, unless otherwise agreed by Signify.

DSRT-Selectable-Troffer-spec-sheet-en 09/24 page 5 of 5



Signify North America Corp.
 400 Crossing Blvd, Suite 600
 Bridgewater, NJ 08807
 Telephone: 800-555-0050

Signify Canada Ltd.
 281 Hillmount Road,
 Markham, ON, Canada L6C 2S3
 Telephone: 800-668-9008

All trademarks are owned by Signify Holding or their respective owners.

www.day-brite.com



Job Name : NEW TRAINING FACILITY ST. TAMMANY FIRE PROTECTION DISTRICT 1
Manufacturer : DAY-BRITE
Model Number : 2DSRT3050LCS-2-UNV-DIM

Type :
F2

Day-Brite

CFI

Recessed

DSRT Selectable Troffer

Selectable lumens & CCT



Day-Brite/CFI DSRT Selectable Troffer is a robust low glare luminaire designed to provide three lumen and three CCT field selectable options per size. Available for use in recessed, suspended and surface mount applications. Ideal for general lighting applications such as open office, schools, healthcare, and retail.

Project: _____
 Location: _____
 Cat. No: _____
 Type: _____
 Qty: _____
 Notes: _____



Ordering guide

Catalog Code	Size	Voltage	Power / Wattage			Lumens ¹			Efficacy		
			3500K	4000K	5000K	3500K	4000K	5000K	3500K	4000K	5000K
1DSRT3050LCS-4-UNV-DIM	1x4	UNV	39	39	39	5000	5150	5000	128	132	128
1DSRT3050LCS-4-UNV-DIM	1x4	UNV	31	31	31	4000	4100	4000	129	132	129
1DSRT3050LCS-4-UNV-DIM	1x4	UNV	23	23	23	2850	2900	2900	124	126	126
2DSRT3050LCS-2-UNV-DIM	2x2	UNV	35	35	35	4350	4500	4400	124	129	126
2DSRT3050LCS-2-UNV-DIM	2x2	UNV	28	28	28	3650	3800	3700	130	136	132
2DSRT3050LCS-2-UNV-DIM	2x2	UNV	22	22	22	2750	2750	2800	125	125	127
2DSRT4060LCS-4-UNV-DIM	2x4	UNV	46	46	46	6000	6150	6100	130	134	133
2DSRT4060LCS-4-UNV-DIM	2x4	UNV	39	39	39	5000	5150	5000	128	132	128
2DSRT4060LCS-4-UNV-DIM	2x4	UNV	30	30	30	4000	4100	4000	133	137	133
1DSRT3050LCS-4-UNV-DIM-DAYOCC	1x4	UNV	39	39	39	5000	5150	5000	128	132	128
1DSRT3050LCS-4-UNV-DIM-DAYOCC	1x4	UNV	31	31	31	4000	4100	4000	129	132	129
1DSRT3050LCS-4-UNV-DIM-DAYOCC	1x4	UNV	23	23	23	2850	2900	2900	124	126	126
2DSRT3050LCS-2-UNV-DIM-DAYOCC	2x2	UNV	35	35	35	4350	4500	4400	124	129	126
2DSRT3050LCS-2-UNV-DIM-DAYOCC	2x2	UNV	28	28	28	3650	3800	3700	130	136	132
2DSRT3050LCS-2-UNV-DIM-DAYOCC	2x2	UNV	22	22	22	2750	2750	2800	125	125	127
2DSRT4060LCS-4-UNV-DIM-DAYOCC	2x4	UNV	46	46	46	6000	6150	6100	130	134	133
2DSRT4060LCS-4-UNV-DIM-DAYOCC	2x4	UNV	39	39	39	5000	5150	5000	128	132	128
2DSRT4060LCS-4-UNV-DIM-DAYOCC	2x4	UNV	30	30	30	4000	4100	4000	133	137	133

1. Nominal delivered lumens at 25°C ambient

Accessories (order separately)

- DSRT-CKT-NP - Selectable Troffer Suspension Kit with no Power
- DSRT-CKT-WP - Selectable Troffer Suspension Kit with Power
- 1DSRT-4-SKT - 1x4' Selectable Troffer Surface Kit
- 2DSRT-2-SKT - 2x2' Selectable Troffer Surface Kit
- 2DSRT-4-SKT - 2x4' Selectable Troffer Surface Kit

Not all product variations listed on page are DLC qualified. To ensure that a specific model is qualified, visit www.designlights.org/search





DSRT Selectable Troffer

Selectable lumens & CCT

Application

- Overall 2.76in deep luminaire, including driver box
- Even distribution of light on the lens provide very low glare
- General light distribution creates uniform horizontal and vertical illuminance
- CRI 80 minimum colour rendering with balanced spectrum
- Accessory field install kits available for surface mounting

Field Selectable CCT and Wattage

- CCT can easily be selected in the field between 5000K (CW); 4000K (NW); 3500K (WW).
- Wattage selection allows for easy field selection between three lumen packages (see performance chart for details).
- Factory default settings noted in image below:

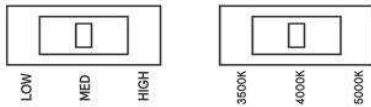

Enclosure

- Polystyrene diffuser provides visual comfort and high efficiency
- Lens is easy to detach for cleaning
- Opal lens provides a uniform aesthetic on the ceiling plane
- Tight enclosure assembly impedes ingress of dust and insects

Electrical

- Up to 125 lm/W efficacy
- Driver featuring high power factor (>0.90), 120-277V 60/50Hz, and less than 25% THD
- Operating temperature -10°C-40°C
- Standard configurations are 0-10V dimming to 1%
- 50,000 hours @ L70B50
- cETLus listed to ETL and CSA standards, suitable for damp locations
- IC rated
- DSRT Selectable Troffer luminaires are Designlights Consortium® Premium qualified.
- Please see the DLC QPL list for exact catalogue numbers www.designlights.org/QPL

Construction/Finish

- Strong and well constructed 3in deep 5VA housing
- Die formed driver box with standard access plate for ease of wiring
- Integral clips accommodate definitive attachment to T-bar grid for recessed applications

Sensor

- DAYOCC sensor options available with 3 control settings (Occupancy, Daylighting & Dimming)
- Sensor provides five coverage patterns to ensure accuracy

General Notes

- All accessories are field installed.
- All options are factory installed.
- Many luminaire components, such as reflectors, refractors, lenses, sockets, lampholders, and LEDs are made from various types of plastics which can be adversely affected by airborne contaminants. If sulfur based chemicals, petroleum based products, cleaning solutions, or other contaminants are expected in the intended area of use, consult factory for compatibility.
- Five year limited luminaire warranty includes LED boards and driver. Visit www.signify.com/warranties for complete warranty information.

Sensor Features

1. Sensor/0-10V Dim = Enable or Disable Sensor (Default: Enabled)
2. CCT Selector = Choose between 3500K, 4000K or 5000K (Default: 4000K)
3. Power Selector = Choose between Low, Mid or High (Default: High)

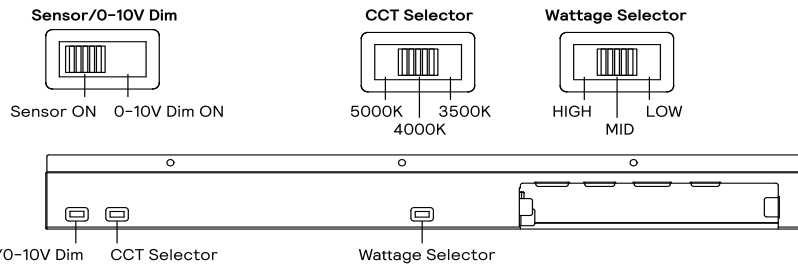

Sensor control settings

Occupied timeout
Switches 1, 2, & 3
Default = 10 seconds

ON ↑
OFF ↓

Time: 1, 2, 3

Time	1	2	3
10 sec	↓	↓	↓
30 sec	↓	↓	↑
1 min	↓	↑	↓
3 min	↓	↑	↑
5 min	↑	↓	↓
10 min	↑	↓	↑
15 min	↑	↑	↓
30 min	↑	↑	↑

Stand-by dimming level
Switch 4
Default = 20% dimming

ON ↑
OFF ↓

Stand-by level: 4

↑ 50%
↓ 20%

Stand-by timing level
Switches 5 & 6
Default = 1 minute

ON ↑
OFF ↓

Stand-by L-times: 5, 6

Time	5	6
1 min	↓	↓
30 min	↓	↑
60 min	↑	↓
+∞	↑	↑



Job Name : NEW TRAINING FACILITY ST. TAMMANY FIRE PROTECTION DISTRICT 1
Manufacturer : DAY-BRITE
Model Number : 2DSRT3050LCS-2-UNV-DIM

Type :
F2

DSRT Selectable Troffer

Selectable lumens & CCT

Standard Configurations

2x2 dimensions

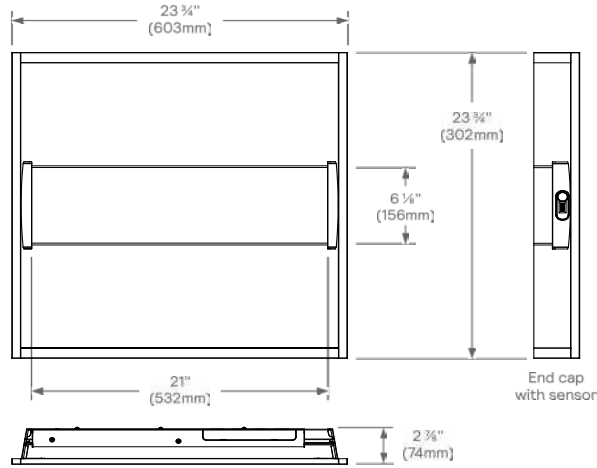

1x4 dimensions

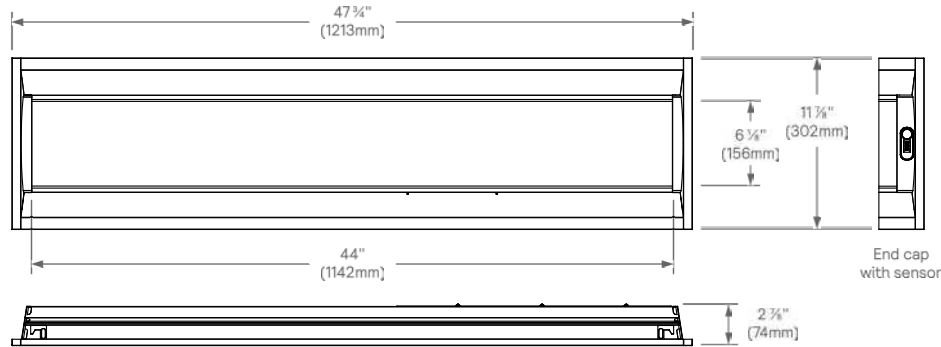

2x4 dimensions

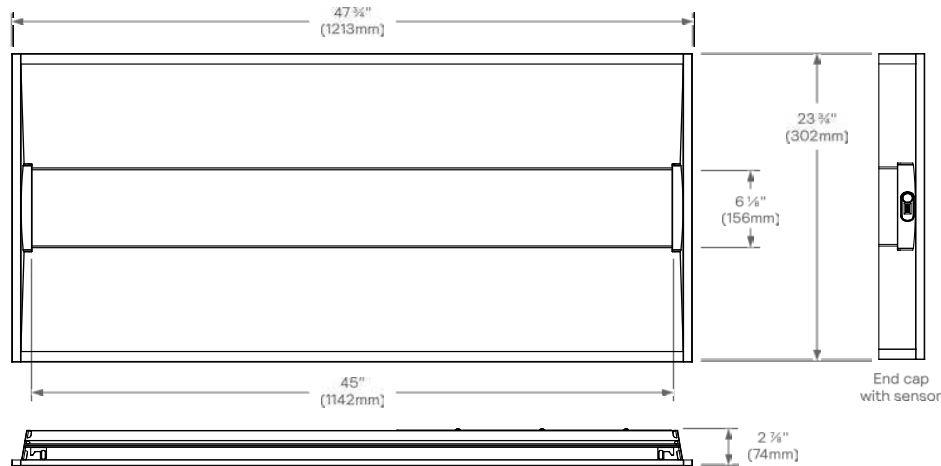

DSRT-Selectable-Troffer-spec-sheet-en 11/21 page 3 of 5



DSRT Selectable Troffer

Selectable lumens & CCT

Photometry

1DSRT3050LCS-4-UNV-DIM H

Luminaire Lumens 5000
 Luminaire Efficacy Rating (LER) 132
 Total Luminaire Watts 38
 Spacing Criterion (0-180) 1.28

Candela Distribution						Flux
	0	22.5	45	67.5	90	Lumens
0	1674	1674	1674	1674	1674	
5	1667	1667	1667	1667	1667	159
15	1608	1608	1608	1608	1607	454
25	1488	1488	1487	1487	1487	684
35	1304	1304	1304	1304	1304	815
45	1057	1057	1057	1057	1057	822
55	737	739	741	745	749	703
65	399	403	408	420	432	500
75	155	160	165	178	191	294
85	26	27	28	33	37	69
90	0	0	0	0	1	

Zonal Lumen Summary			
Zone	Lumens	%Fixture	%Lamp
0-30	1439	28.8%	28.8%
0-40	2356	47.1%	47.1%
0-60	4108	82.2%	82.2%
0-90	5000	100.0%	100.0%
0-180	4721	100.00%	100.00%

Average Luminance (cd/m ²)			
	0	90	180
45	4785	4703	4584
55	4327	4359	4296
65	3422	3884	3631
75	2330	2845	2180
85	1233	1380	1067

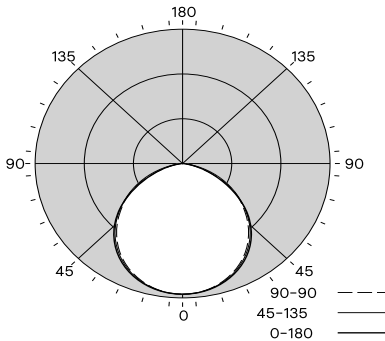

Coefficients of Utilization %											
Pc---	80				70			50		0	
Pw---	70	50	30	10	70	50	30	50	30	10	0
RCR											
0	119	119	119	119	116	116	116	111	111	111	100
1	109	105	101	97	107	103	99	98	95	93	85
2	100	92	86	80	97	90	84	87	82	77	72
3	91	81	73	67	89	80	72	77	70	65	61
4	84	72	64	57	81	71	63	68	61	56	52
5	77	64	56	49	75	63	55	61	54	48	45
6	71	58	49	43	69	57	49	55	48	42	40
7	66	53	44	38	64	52	44	50	43	38	35
8	61	48	40	34	60	47	39	46	39	34	31
9	57	44	36	31	56	44	36	42	35	30	28
10	54	41	33	28	53	40	33	39	32	28	26

2DSRT3050LCS-2-UNV-DIM H

Luminaire Lumens 4095
 Luminaire Efficacy Rating (LER) 125
 Total Luminaire Watts 32.8
 Spacing Criterion (0-180) 1.27

Candela Distribution						Flux
	0	22.5	45	67.5	90	Lumens
0	1674	1674	1674	1674	1674	
5	1667	1667	1667	1667	1667	159
15	1608	1608	1608	1608	1607	454
25	1488	1488	1487	1487	1487	684
35	1304	1304	1304	1304	1304	815
45	1057	1057	1057	1057	1057	822
55	737	739	741	745	749	703
65	399	403	408	420	432	500
75	155	160	165	178	191	294
85	26	27	28	33	37	69
90	0	0	0	0	1	

Zonal Lumen Summary			
Zone	Lumens	%Fixture	%Lamp
0-30	1296	28.8%	28.8%
0-40	2111	46.9%	46.9%
0-60	3635	80.8%	80.8%
0-90	4500	100.0%	100.0%
0-180	4095	100.00%	100.00%

Average Luminance (cd/m ²)			
	0	90	180
45	4100	4130	4190
55	3526	3771	3966
65	2589	3324	3785
75	1645	3031	3980
85	804	1907	1600

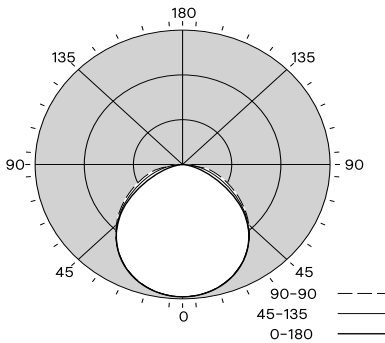

Coefficients of Utilization %											
Pc---	80				70			50		0	
Pw---	70	50	30	10	70	50	30	50	30	10	0
RCR											
0	119	119	119	119	116	116	116	111	111	111	100
1	110	106	102	98	107	103	100	99	96	94	86
2	101	93	87	81	98	91	85	88	83	79	73
3	92	82	75	69	90	81	74	78	72	67	62
4	85	73	65	59	82	72	64	70	63	57	54
5	78	66	57	51	76	65	57	63	55	50	47
6	72	59	51	45	70	58	50	57	49	44	41
7	67	54	46	40	65	53	45	52	44	39	37
8	62	49	41	35	61	49	41	47	40	35	33
9	58	45	37	32	57	45	37	44	37	32	30
10	55	42	34	29	54	41	34	40	34	29	27



Job Name : NEW TRAINING FACILITY ST. TAMMANY FIRE PROTECTION DISTRICT 1
Manufacturer : DAY-BRITE
Model Number : 2DSRT3050LCS-2-UNV-DIM

Type :
F2

DSRT Selectable Troffer

Selectable lumens & CCT

Photometry

2DSRT4060LCS-4-UNV-DIM H

Luminaire Lumens 6000
Luminaire Efficacy Rating (LER) 130
Total Luminaire Watts 46
Spacing Criterion (0-180) 1.28

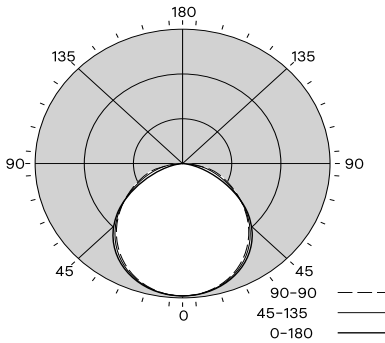

Candela Distribution						Flux
	0	22.5	45	67.5	90	Lumens
0	2168	2168	2168	2168	2168	
5	2159	2159	2159	2159	2159	206
15	2094	2093	2093	2092	2091	589
25	1959	1958	1957	1955	1953	892
35	1748	1747	1746	1742	1739	1070
45	1454	1452	1451	1446	1441	1090
55	1061	1061	1061	1060	1059	948
65	608	613	619	631	644	692
75	244	252	259	278	298	416
85	43	47	51	64	77	97
90	1	1	1	1	1	

Zonal Lumen Summary			
Zone	Lumens	%Fixture	%Lamp
0-30	1685	28.1%	28.1%
0-40	2754	45.9%	45.9%
0-60	4792	79.9%	79.9%
0-90	6000	100.0%	100.0%
0-180	3788	100.00%	100.00%

Average Luminance (cd/m ²)			
	0	90	180
45	5641	5476	5368
55	5076	5075	5076
65	3945	4605	4898
75	2585	4426	5209
85	1337	2733	1624

Coefficients of Utilization %											
Pc---	80				70			50		0	
Pw---	70	50	30	10	70	50	30	50	30	10	0
RCR											
0	119	119	119	119	116	116	116	111	111	111	100
1	110	105	101	97	107	103	99	99	96	93	85
2	100	92	86	80	97	90	84	87	82	77	72
3	91	81	74	67	89	80	73	77	71	65	61
4	84	72	64	57	82	71	63	68	62	56	52
5	77	65	56	50	75	64	55	61	54	49	46
6	71	58	50	43	69	57	49	56	48	43	40
7	66	53	44	38	64	52	44	51	43	38	35
8	62	48	40	34	60	48	40	46	39	34	32
9	58	44	36	31	56	44	36	43	36	31	28
10	54	41	33	28	53	40	33	39	32	28	26

© 2024 Signify Holding. All rights reserved. The information provided herein is subject to change, without notice. Signify does not give any representation or warranty as to the accuracy or completeness of the information included herein and shall not be liable for any action in reliance thereon. The information presented in this document is not intended as any commercial offer and does not form part of any quotation or contract, unless otherwise agreed by Signify.

DSRT-Selectable-Troffer-spec-sheet-en 09/24 page 5 of 5



Signify North America Corp.
 400 Crossing Blvd, Suite 600
 Bridgewater, NJ 08807
 Telephone: 800-555-0050

Signify Canada Ltd.
 281 Hillmount Road,
 Markham, ON, Canada L6C 2S3
 Telephone: 800-668-9008

All trademarks are owned by Signify Holding or their respective owners.

www.day-brite.com



Job Name : NEW TRAINING FACILITY ST. TAMMANY FIRE PROTECTION DISTRICT 1
Manufacturer : DAY-BRITE
Model Number : 2DSRT3050LCS-2-UNV-DIM / FMA22

Type :
F2A

Day-Brite

CFI

Recessed

DSRT Selectable Troffer

Selectable lumens & CCT



Day-Brite/CFI DSRT Selectable Troffer is a robust low glare luminaire designed to provide three lumen and three CCT field selectable options per size. Available for use in recessed, suspended and surface mount applications. Ideal for general lighting applications such as open office, schools, healthcare, and retail.

Project: _____
 Location: _____
 Cat. No: _____
 Type: _____
 Qty: _____
 Notes: _____



Ordering guide

Catalog Code	Size	Voltage	Power / Wattage			Lumens ¹			Efficacy		
			3500K	4000K	5000K	3500K	4000K	5000K	3500K	4000K	5000K
1DSRT3050LCS-4-UNV-DIM	1x4	UNV	39	39	39	5000	5150	5000	128	132	128
1DSRT3050LCS-4-UNV-DIM	1x4	UNV	31	31	31	4000	4100	4000	129	132	129
1DSRT3050LCS-4-UNV-DIM	1x4	UNV	23	23	23	2850	2900	2900	124	126	126
2DSRT3050LCS-2-UNV-DIM	2x2	UNV	35	35	35	4350	4500	4400	124	129	126
2DSRT3050LCS-2-UNV-DIM	2x2	UNV	28	28	28	3650	3800	3700	130	136	132
2DSRT3050LCS-2-UNV-DIM	2x2	UNV	22	22	22	2750	2750	2800	125	125	127
2DSRT4060LCS-4-UNV-DIM	2x4	UNV	46	46	46	6000	6150	6100	130	134	133
2DSRT4060LCS-4-UNV-DIM	2x4	UNV	39	39	39	5000	5150	5000	128	132	128
2DSRT4060LCS-4-UNV-DIM	2x4	UNV	30	30	30	4000	4100	4000	133	137	133
1DSRT3050LCS-4-UNV-DIM-DAYOCC	1x4	UNV	39	39	39	5000	5150	5000	128	132	128
1DSRT3050LCS-4-UNV-DIM-DAYOCC	1x4	UNV	31	31	31	4000	4100	4000	129	132	129
1DSRT3050LCS-4-UNV-DIM-DAYOCC	1x4	UNV	23	23	23	2850	2900	2900	124	126	126
2DSRT3050LCS-2-UNV-DIM-DAYOCC	2x2	UNV	35	35	35	4350	4500	4400	124	129	126
2DSRT3050LCS-2-UNV-DIM-DAYOCC	2x2	UNV	28	28	28	3650	3800	3700	130	136	132
2DSRT3050LCS-2-UNV-DIM-DAYOCC	2x2	UNV	22	22	22	2750	2750	2800	125	125	127
2DSRT4060LCS-4-UNV-DIM-DAYOCC	2x4	UNV	46	46	46	6000	6150	6100	130	134	133
2DSRT4060LCS-4-UNV-DIM-DAYOCC	2x4	UNV	39	39	39	5000	5150	5000	128	132	128
2DSRT4060LCS-4-UNV-DIM-DAYOCC	2x4	UNV	30	30	30	4000	4100	4000	133	137	133

1. Nominal delivered lumens at 25°C ambient

Accessories (order separately)

- DSRT-CKT-NP - Selectable Troffer Suspension Kit with no Power
- DSRT-CKT-WP - Selectable Troffer Suspension Kit with Power
- 1DSRT-4-SKT - 1x4' Selectable Troffer Surface Kit
- 2DSRT-2-SKT - 2x2' Selectable Troffer Surface Kit
- 2DSRT-4-SKT - 2x4' Selectable Troffer Surface Kit

Not all product variations listed on page are DLC qualified. To ensure that a specific model is qualified, visit www.designlights.org/search





DSRT Selectable Troffer

Selectable lumens & CCT

Application

- Overall 2.76in deep luminaire, including driver box
- Even distribution of light on the lens provide very low glare
- General light distribution creates uniform horizontal and vertical illuminance
- CRI 80 minimum colour rendering with balanced spectrum
- Accessory field install kits available for surface mounting

Field Selectable CCT and Wattage

- CCT can easily be selected in the field between 5000K (CW); 4000K (NW); 3500K (WW).
- Wattage selection allows for easy field selection between three lumen packages (see performance chart for details).
- Factory default settings noted in image below:

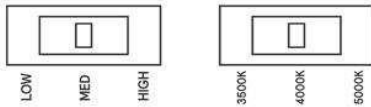

Enclosure

- Polystyrene diffuser provides visual comfort and high efficiency
- Lens is easy to detach for cleaning
- Opal lens provides a uniform aesthetic on the ceiling plane
- Tight enclosure assembly impedes ingress of dust and insects

Electrical

- Up to 125 lm/W efficacy
- Driver featuring high power factor (>0.90), 120-277V 60/50Hz, and less than 25% THD
- Operating temperature -10°C-40°C
- Standard configurations are 0-10V dimming to 1%
- 50,000 hours @ L70B50
- cETLus listed to ETL and CSA standards, suitable for damp locations
- IC rated
- DSRT Selectable Troffer luminaires are Designlights Consortium® Premium qualified.
- Please see the DLC QPL list for exact catalogue numbers www.designlights.org/QPL

Construction/Finish

- Strong and well constructed 3in deep 5VA housing
- Die formed driver box with standard access plate for ease of wiring
- Integral clips accommodate definitive attachment to T-bar grid for recessed applications

Sensor

- DAYOCC sensor options available with 3 control settings (Occupancy, Daylighting & Dimming)
- Sensor provides five coverage patterns to ensure accuracy

General Notes

- All accessories are field installed.
- All options are factory installed.
- Many luminaire components, such as reflectors, refractors, lenses, sockets, lampholders, and LEDs are made from various types of plastics which can be adversely affected by airborne contaminants. If sulfur based chemicals, petroleum based products, cleaning solutions, or other contaminants are expected in the intended area of use, consult factory for compatibility.
- Five year limited luminaire warranty includes LED boards and driver. Visit www.signify.com/warranties for complete warranty information.

Sensor Features

1. Sensor/0-10V Dim = Enable or Disable Sensor (Default: Enabled)
2. CCT Selector = Choose between 3500K, 4000K or 5000K (Default: 4000K)
3. Power Selector = Choose between Low, Mid or High (Default: High)

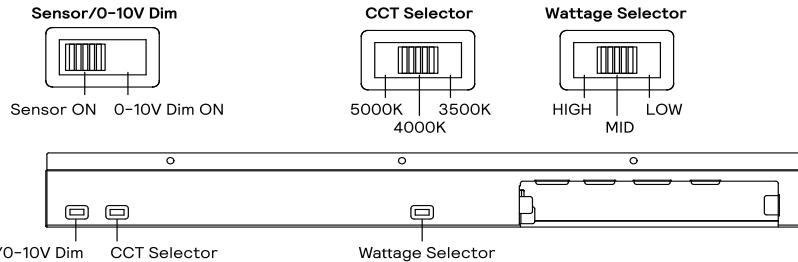

Sensor control settings

Occupied timeout
Switches 1, 2, & 3
Default = 10 seconds

ON ↑
OFF ↓

Time: 1, 2, 3

Time	1	2	3
10 sec	↓	↓	↓
30 sec	↓	↓	↑
1 min	↓	↑	↓
3 min	↓	↑	↑
5 min	↑	↓	↓
10 min	↑	↓	↑
15 min	↑	↑	↓
30 min	↑	↑	↑

Stand-by dimming level
Switch 4
Default = 20% dimming

ON ↑
OFF ↓

Stand-by level: 4

↑ 50%
↓ 20%

Stand-by timing level
Switches 5 & 6
Default = 1 minute

ON ↑
OFF ↓

Stand-by L-times: 5, 6

Time	5	6
1 min	↓	↓
30 min	↓	↑
60 min	↑	↓
+∞	↑	↑



DSRT Selectable Troffer

Selectable lumens & CCT

Standard Configurations

2x2 dimensions

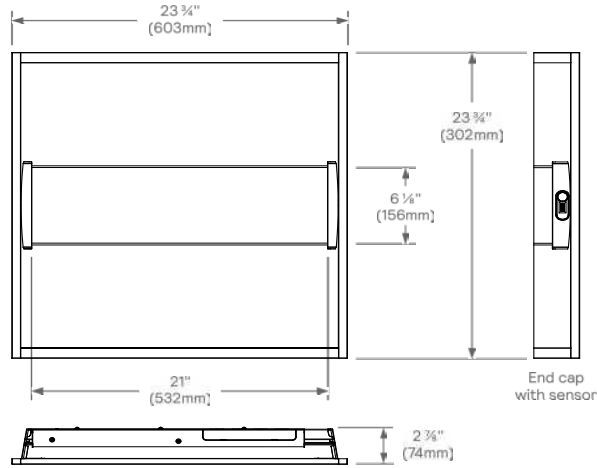

1x4 dimensions

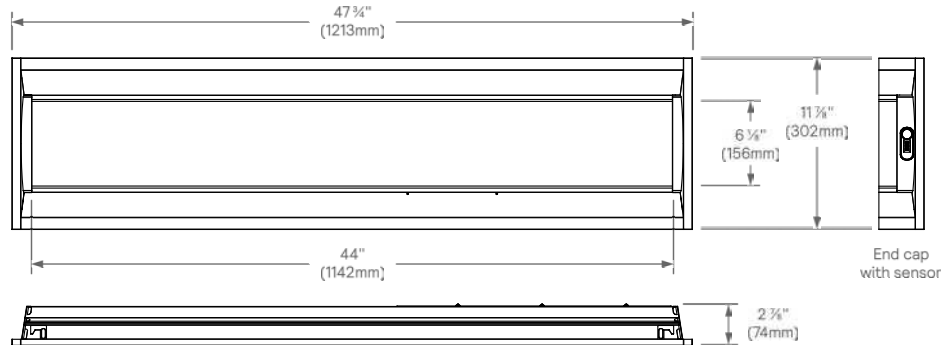

2x4 dimensions

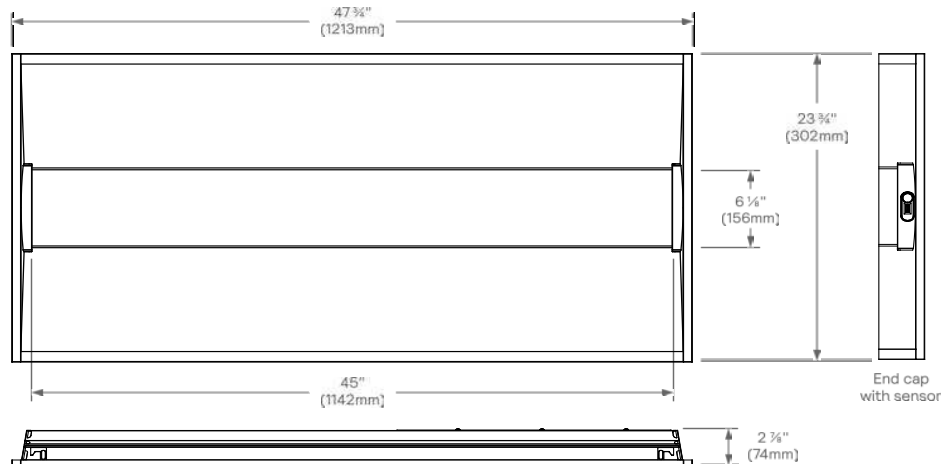



DSRT Selectable Troffer

Selectable lumens & CCT

Photometry

1DSRT3050LCS-4-UNV-DIM H

Luminaire Lumens 5000
 Luminaire Efficacy Rating (LER) 132
 Total Luminaire Watts 38
 Spacing Criterion (0-180) 1.28

Candela Distribution						Flux
	0	22.5	45	67.5	90	Lumens
0	1674	1674	1674	1674	1674	
5	1667	1667	1667	1667	1667	159
15	1608	1608	1608	1608	1607	454
25	1488	1488	1487	1487	1487	684
35	1304	1304	1304	1304	1304	815
45	1057	1057	1057	1057	1057	822
55	737	739	741	745	749	703
65	399	403	408	420	432	500
75	155	160	165	178	191	294
85	26	27	28	33	37	69
90	0	0	0	0	1	

Zonal Lumen Summary			
Zone	Lumens	%Fixture	%Lamp
0-30	1439	28.8%	28.8%
0-40	2356	47.1%	47.1%
0-60	4108	82.2%	82.2%
0-90	5000	100.0%	100.0%
0-180	4721	100.00%	100.00%

Average Luminance (cd/m ²)			
	0	90	180
45	4785	4703	4584
55	4327	4359	4296
65	3422	3884	3631
75	2330	2845	2180
85	1233	1380	1067

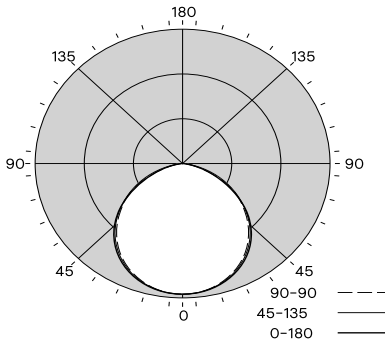

Coefficients of Utilization %

Pc---	80				70				50				0								
Pw---	70	50	30	10	70	50	30	50	30	10	0	70	50	30	10	70	50	30	10	0	
RCR																					
0	119	119	119	119	116	116	116	111	111	111	100										
1	109	105	101	97	107	103	99	98	95	93	85										
2	100	92	86	80	97	90	84	87	82	77	72										
3	91	81	73	67	89	80	72	77	70	65	61										
4	84	72	64	57	81	71	63	68	61	56	52										
5	77	64	56	49	75	63	55	61	54	48	45										
6	71	58	49	43	69	57	49	55	48	42	40										
7	66	53	44	38	64	52	44	50	43	38	35										
8	61	48	40	34	60	47	39	46	39	34	31										
9	57	44	36	31	56	44	36	42	35	30	28										
10	54	41	33	28	53	40	33	39	32	28	26										

2DSRT3050LCS-2-UNV-DIM H

Luminaire Lumens 4095
 Luminaire Efficacy Rating (LER) 125
 Total Luminaire Watts 32.8
 Spacing Criterion (0-180) 1.27

Candela Distribution						Flux
	0	22.5	45	67.5	90	Lumens
0	1674	1674	1674	1674	1674	
5	1667	1667	1667	1667	1667	159
15	1608	1608	1608	1608	1607	454
25	1488	1488	1487	1487	1487	684
35	1304	1304	1304	1304	1304	815
45	1057	1057	1057	1057	1057	822
55	737	739	741	745	749	703
65	399	403	408	420	432	500
75	155	160	165	178	191	294
85	26	27	28	33	37	69
90	0	0	0	0	1	

Zonal Lumen Summary			
Zone	Lumens	%Fixture	%Lamp
0-30	1296	28.8%	28.8%
0-40	2111	46.9%	46.9%
0-60	3635	80.8%	80.8%
0-90	4500	100.0%	100.0%
0-180	4095	100.00%	100.00%

Average Luminance (cd/m ²)			
	0	90	180
45	4100	4130	4190
55	3526	3771	3966
65	2589	3324	3785
75	1645	3031	3980
85	804	1907	1600

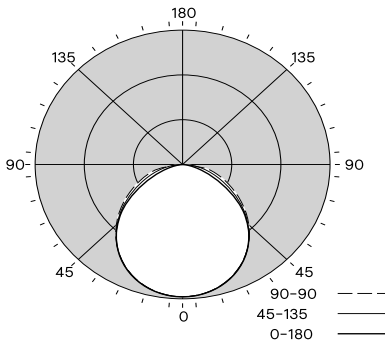

Coefficients of Utilization %

Pc---	80				70				50				0								
Pw---	70	50	30	10	70	50	30	50	30	10	0	70	50	30	10	70	50	30	10	0	
RCR																					
0	119	119	119	119	116	116	116	111	111	111	100										
1	110	106	102	98	107	103	100	99	96	94	86										
2	101	93	87	81	98	91	85	88	83	79	73										
3	92	82	75	69	90	81	74	78	72	67	62										
4	85	73	65	59	82	72	64	70	63	57	54										
5	78	66	57	51	76	65	57	63	55	50	47										
6	72	59	51	45	70	58	50	57	49	44	41										
7	67	54	46	40	65	53	45	52	44	39	37										
8	62	49	41	35	61	49	41	47	40	35	33										
9	58	45	37	32	57	45	37	44	37	32	30										
10	55	42	34	29	54	41	34	40	34	29	27										



Job Name : NEW TRAINING FACILITY ST. TAMMANY FIRE PROTECTION DISTRICT 1
Manufacturer : DAY-BRITE
Model Number : 2DSRT3050LCS-2-UNV-DIM / FMA22

Type :
F2A

DSRT Selectable Troffer

Selectable lumens & CCT

Photometry

2DSRT4060LCS-4-UNV-DIM H

Luminaire Lumens 6000
Luminaire Efficacy Rating (LER) 130
Total Luminaire Watts 46
Spacing Criterion (0-180) 1.28

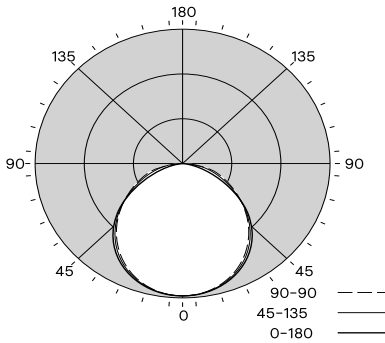

Candela Distribution						Flux
	0	22.5	45	67.5	90	Lumens
0	2168	2168	2168	2168	2168	
5	2159	2159	2159	2159	2159	206
15	2094	2093	2093	2092	2091	589
25	1959	1958	1957	1955	1953	892
35	1748	1747	1746	1742	1739	1070
45	1454	1452	1451	1446	1441	1090
55	1061	1061	1061	1060	1059	948
65	608	613	619	631	644	692
75	244	252	259	278	298	416
85	43	47	51	64	77	97
90	1	1	1	1	1	

Zonal Lumen Summary			
Zone	Lumens	%Fixture	%Lamp
0-30	1685	28.1%	28.1%
0-40	2754	45.9%	45.9%
0-60	4792	79.9%	79.9%
0-90	6000	100.0%	100.0%
0-180	3788	100.00%	100.00%

Average Luminance (cd/m ²)			
	0	90	180
45	5641	5476	5368
55	5076	5075	5076
65	3945	4605	4898
75	2585	4426	5209
85	1337	2733	1624

Coefficients of Utilization %											
Pc---	80				70			50		0	
Pw---	70	50	30	10	70	50	30	50	30	10	0
RCR											
0	119	119	119	119	116	116	116	111	111	111	100
1	110	105	101	97	107	103	99	99	96	93	85
2	100	92	86	80	97	90	84	87	82	77	72
3	91	81	74	67	89	80	73	77	71	65	61
4	84	72	64	57	82	71	63	68	62	56	52
5	77	65	56	50	75	64	55	61	54	49	46
6	71	58	50	43	69	57	49	56	48	43	40
7	66	53	44	38	64	52	44	51	43	38	35
8	62	48	40	34	60	48	40	46	39	34	32
9	58	44	36	31	56	44	36	43	36	31	28
10	54	41	33	28	53	40	33	39	32	28	26

© 2024 Signify Holding. All rights reserved. The information provided herein is subject to change, without notice. Signify does not give any representation or warranty as to the accuracy or completeness of the information included herein and shall not be liable for any action in reliance thereon. The information presented in this document is not intended as any commercial offer and does not form part of any quotation or contract, unless otherwise agreed by Signify.

DSRT-Selectable-Troffer-spec-sheet-en 09/24 page 5 of 5



Signify North America Corp.
 400 Crossing Blvd, Suite 600
 Bridgewater, NJ 08807
 Telephone: 800-555-0050

Signify Canada Ltd.
 281 Hillmount Road,
 Markham, ON, Canada L6C 2S3
 Telephone: 800-668-9008

All trademarks are owned by Signify Holding or their respective owners.

www.day-brite.com



Job Name : NEW TRAINING FACILITY ST. TAMMANY FIRE PROTECTION DISTRICT 1
Manufacturer : LIGHTOLIER
Model Number : 6RN / P6RDL15930WCLZ10U

Type :
F3

Downlighting

LyteProfile

P6R 6" Round Downlight & Wall Wash



LIGHTOLIER
 by **Signify**

Project: _____
 Location: _____
 Cat.No: _____
 Type: _____
 Qty: _____
 Notes: _____

LyteProfile downlights and wall washers provide a perfect balance of functionality with glare control. The robust and versatile UniFrame frame-in kit makes changes and updates easy to manage and install. High optical efficiency reinforced with Accurender technology provides an optimum balance of performance and quality of light. Ideal for use in a variety of applications including open office, institutional, healthcare, and retail.

Standard luminaire = Frame + Engine/Trim + Accessories (optional)

Buy American Act of 1933 (BAA)** Compliant luminaire* = Frame-BAC + Engine/Trim-BAC

* BAA compliance requires that BAC option be selected for each of frame and engine/trim. Frame and engine/trim will be ordered/shipped together (ex: 6RN-BAC-P6RDL20935CDZ10U-BAC). Accessories (optional) are not currently BAA-compliant.

Frame

Standard example: 6RN | BAC example: 6RN-BAC

Series	Aperture	Installation	Options
6	R	<input type="checkbox"/>	<input type="checkbox"/>
6 Uniframe 6-inch Non-IC	R Round	N New construction (Non-IC)	— Universal 120/277/347V EM6 Emergency, 6W Self-Test/Self-Diagnostic (not available for BAC) ¹ RADIO Integral Interact Pro RF sensor (120/277/347V) (enables wireless connected lighting control) ⁴
		R Remodeler (Non-IC)	— Universal 120/277/347V
		A AirSeal (IC)	— Universal 120/277/347V BAC Meets the requirements of the Buy American Act of 1933 (BAA)**

Engine / Trim

Standard example: P6RDL20935CDZ10U | BAC example: P6RDL20935CDZ10U-BAC

Series	Style	Lumen	CRI/CCT	Beam	Reflector	Flange	Dimming / Options	Voltage	Options
P6R	<input type="checkbox"/>	<input type="checkbox"/>	<input type="checkbox"/>	<input type="checkbox"/>	<input type="checkbox"/>	<input type="checkbox"/>	<input type="checkbox"/>	<input type="checkbox"/>	<input type="checkbox"/>
P6R LyteProfile 6-inch Round downlight	DL Downlight LW Lensed Wall Wash ² SL Shower light ³ (non-conductive lens)	10 1000lm 15 1500lm 20 2000lm 25 2500lm 30 3000lm 35 3500lm	927 90CRI/2700K 930 90CRI/3000K 935 90CRI/3500K 940 90CRI/4000K 827 80CRI/2700K 830 80CRI/3000K 835 80CRI/3500K 840 80CRI/4000K	N Narrow M Medium — Wide	CL Specular clear CC Comfort clear CD Comfort clear diffuse WH White (matte) BK Black (matte) WHAMF White (gloss antimicrobial)	— White (matte) B Black (matte) P Polished (matches aperture) F Flangeless (requires CA4RFT) — White (matte) B Black (matte) F Flangeless (requires CA4RFT) — White (gloss) F Flangeless (requires CA4RFT)	Z10 0-10V 1% Z10D20 0-10V 1% (dim to Off) RA Integral Interact Pro RF sensor ⁴ (enables wireless connected lighting control) E Forward & Reverse Phase LTE Lutron LTE Hi-Lume Phase Cut 1% (500lm not available) P Power over Ethernet Only compatible with 1000lm (10) to 2500lm (25)	U 120/277V 3 347V (Z10 only) U 120/277V 1 120V E 48V DC	— None R Retrofit ⁵ (not compatible with IEM6) IEM6 Trim mounted EM test switch ⁶ BAC Meets the requirements of the Buy American Act of 1933 (BAA)**

Accessories (Not currently BAA-compliant - learn more on page 2)

SBA	Interact Ready System Bridge Accessory with integral occupancy and daylight sensor (compatible with all 0-10V options, see SBA spec sheet) ⁷
CAEM6	Field installable Bodine BSL6 6W battery pack with self-test/self-diagnostic for use with new construction frames, 120-277V
CA4RFT	Mud-in ring for use in 4" round flangeless trim installations (ordered with a flangeless (F) light engine).
CAEM6TSCP	Remote switch cover plate. Order with EM6 frame for remote mounted test switch.
C4RVPWH	IP65 rated vandal proof matte white accessory mounts onto flangeless light engines (F) and non-IC (N) frame only.
T347-75VA	347:120V step-down transformer for non-IC (N) frame only (see page 2 for details)
7925	6" sloped ceiling adapter (refer to SCA spec sheet for slope options)
AMS	ActiLume multi-sensor (optional accessory for PoE configurations)

- Emergency (EM6) frame is compatible with reflector mounted test switch when light engine is ordered with IEM6 option code (not compatible with 347V or Power over Ethernet configurations).
- Lensed wall wash (LW) style only available with Wide (blank) beam.
- Shower light (SL) is only available with White (WH) reflector finish.
- Linear driver profile (see page 7 for details).
- Retrofits select legacy Lightolier luminaires (see pages 2 for details).
- IEM6 option available on DL style only.
- Requires IRT9015 IR remote and Interact Pro App for commissioning.

** Failure to properly select the "BAC" suffix could result in you receiving product that is not BAA compliant product with no recourse for an RMA or refund. This BAC designation hereunder does not address (i) the applicability of, or availability of a waiver under, the Trade Agreements Act, or (ii) the "Buy America" domestic content requirements imposed on states, localities, and other non-federal entities as a condition of receiving funds administered by the Department of Transportation or other federal agencies.





P6R LyteProfile 6"

Round Downlight & Lensed Wall Wash

Features

Optics

- Provides a 60° cutoff (physical and reflected)
- Wide beam distribution for general illumination
- Spun and anodized reflectors available in specular (clear), semi-specular (comfort clear and diffuse finishes. Also available in white and black painted finishes.
- Consult factory for RAL finishes

Quality of light

- Color consistency: 2 SDCM
- 90 CRI minimum (Accrender)

Construction (New Construction)

- Galvanized stamped steel for dry / plaster ceilings.
- Pre-installed telescoping mounting bars (13"-24")
- Frame accommodates C- channel, black iron, and 3/4" EMT for mounting distances greater than 24" between joists.
- Manufactured from 20 gage galvanized steel construction with rolled edge aperture to guide cutting tools for perfect hole cutting.

Max ceiling thickness is 2" (51 mm). Including PoE frame 4.88" (124 mm).

Patented install Mounting frame

- Pre-installed mounting bars allow for fast and tool-less install into T-grid & hat channel ceilings
- Close-cut aperture design eliminates an undesired gap between ceiling material and reflector.
- Simple plug-and-play connection between frame and light engine from below the ceiling allows for:
 - Easy upgrades
 - Technology changes
 - Repairs and troubleshooting

Dimming

- Advance 0-10v 1% (Z10), logarithmic curve is standard. Specify D20 for factory-set dim-to-off function, consult factory for linear dimming curve.
- Lutron LDE1 (L1) EcoSystem 1%
- Lutron LTE (LTE) Hi-Lume 2-wire phase cut 1%
- Electronic low voltage (E) - forward or reverse phase dimming

Light engine

Quick connect power pack allow for easy installation and replacement from below ceiling with no need for additional wiring. This allows for:

- Frame and ceiling installation to be performed while still finalizing details such as lumen packages, CCT and control type.
- Easy replacement of electronics at end of life with minimal wasted material and labor required.
- Ease and upgradability of technology.
- Lumen Maintenance: L80 at 60,000 hours.
- 347V light engines are Z10 dimming only and include dedicated 347V driver. For 347V non-Z10 dimming, order T347-75VA field-installed step-down transformer accessory.

Emergency

Bodine BSL6 6W battery pack with self-test/diagnostic functionality. Factory or field mounted to frame.

- For trim with integral emergency test switch, order light engine with IEM6 option (ex: P6RDL20835CDZ10UIEM6). DL style only.
- For remote ceiling mounted test switch, order standard light engine (ex: P6RDL20835CDZ10U). Optional accessory ceiling mounting plate available (CAEM6TSACP) for remote mounted test switch.
- Refer to Calculite-LyteProfile-EasyLyte Emergency Battery Pack specification sheet for more details.
- CEC Title 24 JA8 Certified.

Retrofit

- Easily updates legacy LyteProfile LED downlights to the latest technology. Includes light engine, trim, and driver mounted on cover plate that mounts to previous generations of LyteProfile LED luminaires. Order with R option code at end of light engine/trim catalog number.

Power over Ethernet

Powered via Philips PoE lighting controller: complies with FCC rules per Title 47 part 15 (Class A) for EMI / RFI (conducted & radiated). PoE lighting controller accessible from below ceiling.

Options and Accessories

Sloped ceilings: Compatible with sloped ceiling adapters (see SCA spec sheet).

Flangeless mud-in ring: Use CA4RFT For use with flangeless plaster installations.

Field Installed Emergency: Refer to Calculite-LyteProfile-EasyLyte Emergency Battery Pack specification sheet for more details.

- **CAEM6:** Field install EM6 kit with Bodine BSL6 6W battery pack with self-test/self-diagnostic, mounts to new construction frames. Includes remote ceiling plate for test switch. To mount test switch to trim for new construction frame, order downlight light engine with IEM6 option code (e.g. P6RDL20835CDZ10UIEM6).

C6RVPWH: includes machined aluminum ring painted white, gasketed for IP65 protection, and impact resistant polycarbonate lens (IK10). Locks in place with discrete setscrew (key included). Available also with antimicrobial finish (C6RVPWHAMF).

CAEM6TSACP: Ceiling cover plate for remote mounted EM6 test switch. 1/2" (25mm) hole, 4 3/8" (109mm) x 2 3/4" (69mm) rectangular. Includes two mounting screws. Required for lensed wall wash (LW) and shower light (SL) styles.

T347-75VA: Field installable 347:120V 75VA step-down transformer, attaches to knock out on frame junction box, for use with non-IC (N) or remodel (R) frames.

ENERGY STAR® exceptions

- 500lm configurations
- Black finishes
- PoE drivers

Labels and Listings

- cULus listed for wet locations
- CCEA (frames with *LC suffix)
- ENERGY STAR® certified
- RoHS certified

Warranty

 5 year limited warranty Visit Signify.com/warranties for more information on Signify's standard 5-year limited warranty on complete luminaire systems.



P6R LyteProfile 6"

Round Downlight & Lensed Wall Wash

interact

Interact Pro scalable system			
	Foundation	Advanced	Enterprise
Dimming, grouping, and zoning	✓	✓	✓
Bluetooth and ZigBee enabled	✓	✓	✓
Motion sensing and daylight harvesting	✓	✓	✓
Integration with 0-10V and phase dimming fixtures	✓	✓	✓
Code compliance	✓	✓	✓
Granular dimming and dwell time	✓	✓	✓
Energy reporting and monitoring		✓	✓
Scheduling		✓	✓
Demand response		✓	✓
BMS integration (BACnet)			✓
Floor plan visualization			✓
IoT sensors for wellness			✓
IoT Apps for productivity			✓

Currently supported maximum system size

To be able to design the lighting system correctly for the customer, it is important to know the prime characteristics of the system, its possibilities and limitations.

System level	
Total number of gateways	Unlimited
Total number of devices	200 per network
• luminaires with integrated sensors	150
• smart TLEDS	150
Total number of ZGP devices (sensors and switches)	50
• sensors	30
• switches	50
• zones and groups	64
Group level	
Recommended number of lights	40 (recommended 25)
Number of ZGP devices	5
Number of scenes	16

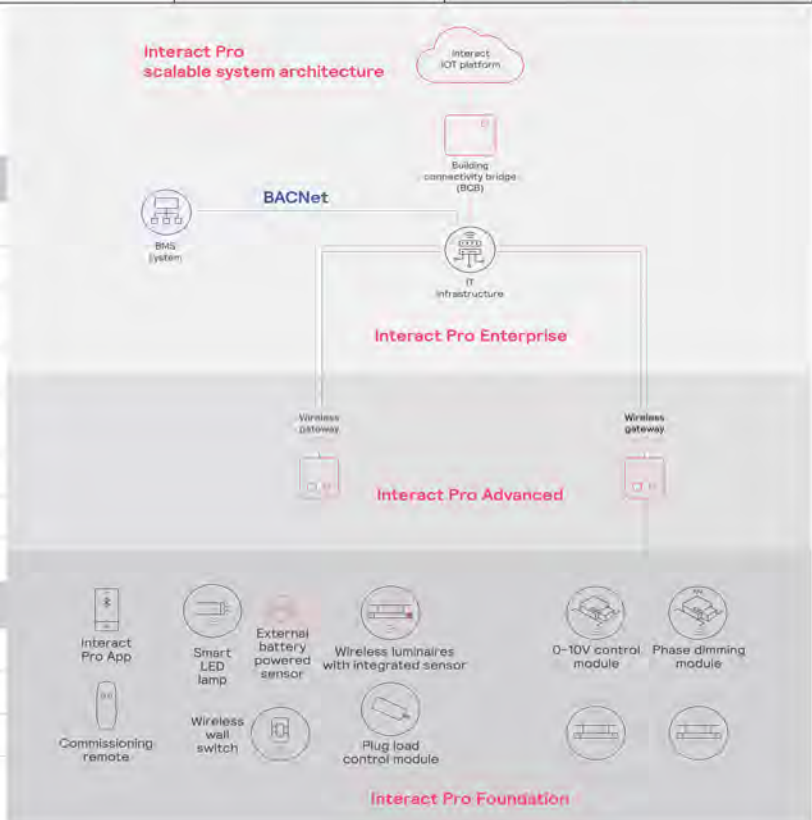



P6R LyteProfile 6"

Round Downlight & Lensed Wall Wash

Wireless Controls Options

Interact Pro scalable sensor (System Bridge Accessory with -CS option):

- CS is a connected sensor with integral occupancy and daylight sensing and supports wireless mesh connectivity.
- The sensor works in the Foundation mode (similar to SpaceWise) when configured without a gateway or in an Interact Pro Advanced or Enterprise mode if a compatible gateway is used.
- Interact Pro includes an App, a portal and a broad portfolio of wireless luminaires, lamps and retrofit kits all working on the same system.
- Startup is implemented via Interact Pro App (Android or iPhone) & Bluetooth connectivity. The App provides flexibility to choose between a gateway or non gateway mode for setup.
- Setup with the gateway requires wired internet access to the gateway. It is possible to add a gateway at a later point.
- Prepare project configuration steps remotely and use IRT9015 remote onsite to identify and group devices together.
- Compatible with:
 - SWS200 wireless scene switch
 - Battery powered IP42 presence sensor OCC sensor IA CM WH 10/1
 - Battery powered IP42 presence & daylight sensor OCC-DL sensor IA CM IP42 WH
 - Battery powered IP65 presence sensor OCC sensor IA CM IP65 WH
 - Battery powered IP65 presence & daylight sensor OCC-DL sensor IA CM IP65 WH
- For more information on Interact Pro visit: www.interact-lighting.com/interactproscalablesystem.

Interact Pro Enterprise (System Bridge Accessory with -SB option):

- A wireless IoT connected lighting solution for large enterprises that span across multiple floors, buildings and require multiple gateways.
- View all your projects under one dashboard and easily compare insights from multiple projects in one view.
- Compatible with SWS200 wireless scene switch, wireless Occ sensor (OCC SENSOR IA CM IP42 WH 10/1) and wireless Day/Occ sensor (OCC MULTI SENSOR IA CM WH 10/1) and wireless Occupancy or Daylight & Occupancy sensors available.
- Use Interact software and insights to increase building efficiency, achieve building wide integration and optimize space through occupancy analytics.
- SB option in addition to occupancy and daylight sensing supports advanced IoT capabilities such as people estimation analysis, desk level temperature & humidity sensing, noise classification, and BLE beacon.
- Requires compatible Gateway and internet connectivity for commissioning.
- For more information, visit: www.interact-lighting.com/office or www.usa.lighting.philips.com/systems/system-areas/offices.

Emergency Options (ER100) (System Bridge Accessory with -ER100 option):

- Power Sensing (Factory default) – Recommended UL924 option requires unswitched power sense line, absence of voltage on the normal circuit triggers luminaire to 100% output
- Power Interruption Detection (Field option) – Detects AC power interruption >30ms triggers 90 minute emergency mode with luminaire at 100% output

Radio only sensor (RA):

- Integral RADIO only sensor simply enables wireless mesh connectivity to the luminaire without any occupancy or daylight sensing.
- Ideal for applications where sensing functionality is managed by other Interact devices and the luminaire only needs to have wireless connectivity.
- 120-347V universal

Wired Controls Options

Interact Office Wired (PoE):

- PoE based IoT connected lighting solution for large enterprises that span across multiple floors, buildings and require multiple gateways.
- Use Interact Office software and insights to increase building efficiency, achieve building wide integration and optimize space through occupancy analytics.
- Supports advanced IoT Apps on Personal Control, Space Management, wayfinding, room/desk reservation and offers open APIs for light control and data exchange.
- PoE lighting controller is accessible from below.
- Integral sensor option for occupancy sensing (PIR) and/or daylight harvesting available for additional energy savings.

- Optional integral emergency controller and battery pack provides 600lm nominal output.
- Test switch and indicator light mounted on side of chassis on one end.
- Emergency battery has a 3 month pre-installed shelf life, and must be stored and installed in environments of 20C to 30C (-4F to 86F) ambient, and 45-85% relative humidity.
- For more information on Interact Office Wired, visit: www.interact-lighting.com/office or www.usa.lighting.philips.com/systems/system-areas/offices.

Interact Office Wired (PoE), Static White:

- A wireless IoT connected lighting solution for large enterprises that span across multiple floors, buildings and require multiple gateways.

- View all your projects under one dashboard and easily compare insights from multiple projects in one view.
- Compatible Zigbee Green Power wall dimmer and wireless Occupancy or Daylight & Occupancy sensors available.
- Use Interact Office software and insights to increase building efficiency, achieve building wide integration and optimize space through occupancy analytics.
- Supports advanced IoT Apps on wayfinding, room/desk reservation and offers open APIs
- Requires compatible Interact Office Gateway and internet connectivity for commissioning.
- For more information on Interact Office Wireless, visit: www.interact-lighting.com/office or www.usa.lighting.philips.com/systems/system-areas/offices.



P6R LyteProfile 6"

Round Downlight & Lensed Wall Wash



AccuRender Technology (CRI 90+)

The right light brings colors to life. Our new AccuRender technology helps ensure colors are rendered more accurately and consistently, while doing so as efficiently as CRI 80 products.



Standard CRI 80
 Good color rendering and high efficacy



Standard CRI 90
 Better color rendering and low efficacy



AccuRender
 Best color rendering, color preference and high efficacy

Enjoy design flexibility

Full range of products and options:

- Available soon in across Lightolier portfolio for application flexibility
- Multiple color temperatures (CCTs) and lumen packages offered

Promote savings

High efficacy, with no penalty:

- Energy efficacy compares well to conventional 80 CRI
- Up to 25% more energy savings vs competitor 90 CRI¹
- Helps meet Title 24 requirements

Show your true colors

High color rendering:

- True to life colors to help energize your environment and render better flesh tones critical for healthcare hospitality and retail applications.
- R_a up to 94 CRI R_r up to 92 TM-30
- R_g up to 67 CRI R_{r,hi} up to 91 TM-30
- G_a up to 99 CRI R_s up to 100 TM-30
- C₉ up to 94 CRI R_{ca,hi} up to -5% TM-30

Achieve color balance

Best in class color consistency:

- Promote aesthetic harmony in your space with ≤ 2 SDCM

Electrical

Product	Lumens	Input Volts	Input Frequency	Input Current (A)	Input Power (W)
P6*10*Z10*	1000	120V	50/60Hz	0.072A	8.7W
		277V	50/60Hz	0.032A	8.8W
		347V	50/60Hz	0.029A	10.2W
P6*15*Z10*	1500	120V	50/60Hz	0.113A	13.6W
		277V	50/60Hz	0.049A	13.6W
		347V	50/60Hz	0.044A	15.3W
P6*20*Z10*	2000	120V	50/60Hz	0.157A	18.9W
		277V	50/60Hz	0.068A	19.0W
		347V	50/60Hz	0.059A	20.4W
P6*25*Z10*	2500	120V	50/60Hz	0.197A	23.7W
		277V	50/60Hz	0.085A	23.6W
		347V	50/60Hz	0.071A	24.5W
P6*30*Z10*	3000	120V	50/60Hz	0.245A	29.4W
		277V	50/60Hz	0.106A	29.4W
		347V	50/60Hz	0.088A	30.5W
P6*35*Z10*	3500	120V	50/60Hz	0.288A	34.5W
		277V	50/60Hz	0.124A	34.3W
		347V	50/60Hz	0.102A	35.5W



P6R LyteProfile 6"

Round Downlight & Lensed Wall Wash

Dimensions

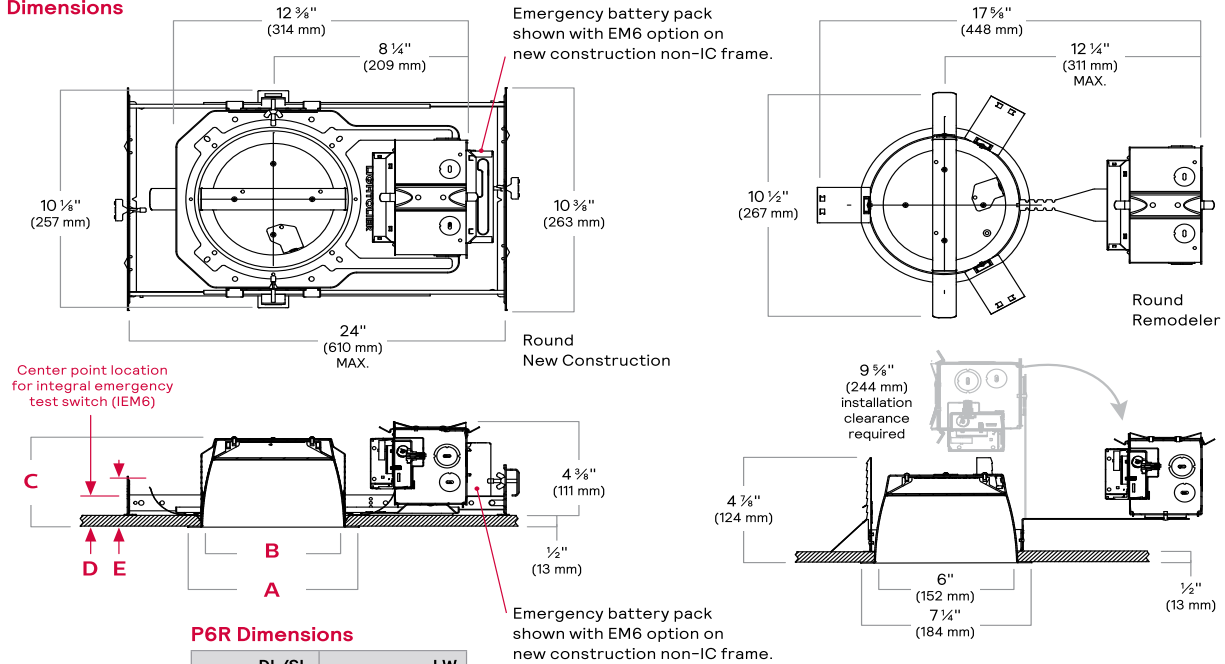

P6R Dimensions

	DL/SL	LW
A	7 1/4" (184mm)	7 1/4" (184mm)
B	6" (152mm)	6" (152mm)
C	4 1/2" (116mm)	4 1/4" (102mm)
D	2 3/8" (60mm)	2 1/4" (65mm)
E	3 3/8" (85mm)	N/A
F	5" (127mm)	4 3/8" (124mm)

- Lower end of LW lens is 3/16" (5mm) above flange.

AirSeal (A)

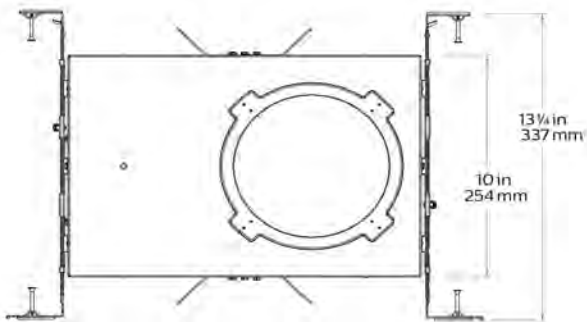

Flangeless mud-in ring (CA6RFT) accessory

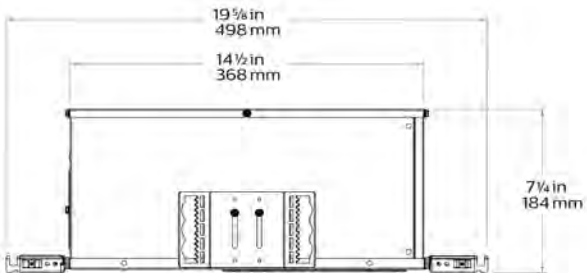
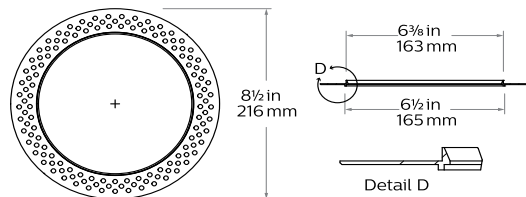

Retrofit (R) with round trim

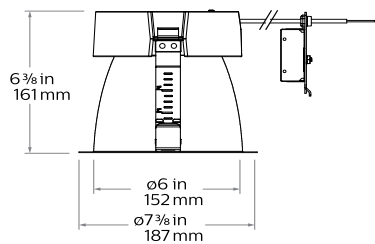

Vandal Proof (VP) accessory

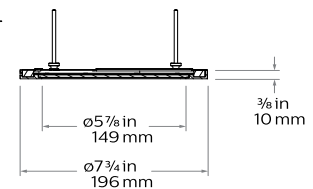



P6R LyteProfile 6"

Round Downlight & Lensed Wall Wash

Reflectors



Specular clear (CL): Most specular and most efficient finish, delivers maximum photometric performance but can produce a mirror image effect of the interior space.



Champagne bronze (CZ): Semi-specular finish that softens light at the source of the reflector while providing a warmer reflector appearance (slightly warmer).



Comfort clear (CC): Semi-specular finish that softens the light at the source of the reflector and creates a subtle, even luminance from the reflector cone.



White (-): (matte) Brightest aperture when illuminated and provides the smoothest transition to most ceilings when off (white is only available with a white flange).



Comfort clear diffuse (CD): Slightly diffuse clear finish, which eliminates iridescence and reduces the mirror image effect inherent with a specular finish.



Black (BK): Painted matte finish that provides the lowest aperture brightness possible and reduces source identification in a ceiling significantly.



Vandal proof (VP): Provides an elegant solution for vandal resistant needs. One piece machined aluminum ring with impact resistant clear lens. Flangeless (F) flange must be ordered. Provides the luminaire with an IK10 impact and IP65 rating.



Shower light (SL): Wet location rated shower light applicable in any installation requiring dead front trims, interior or exterior non-corrosive applications, or where a diffused lens at the ceiling is required (non-conductive).

Flanges



White (-): (matte) Provides the smoothest transition to ceilings when off.



Black (BK): Painted matte finish that provides the lowest aperture brightness possible.



Polished (P): (matches aperture) Produces a continuous look throughout the reflector (aperture matching).



Flangeless (F): (flush-mount) Creates a flush, virtually seamless transition from aperture to ceiling.

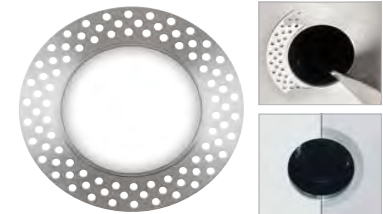

Mud-in ring (FT): Low profile, machined aluminum mud-in ring provides a raised rib to plaster up to and a 3/16" flange thickness. The ring is attached to the ceiling material as opposed to the frame-in kit to avoid conduction of heat and vibration which can cause yellowing or cracking of the plaster.



P6R LyteProfile 6"

Round Downlight & Lensed Wall Wash

Adjustment Factors

Finish	CRI/CCT	Lumens
CL = 100%	90CRI 4000K = 106%	3500lm = 117%
CC = 86%	90CRI 3500K = 104%	3000lm = 100%
CD = 91%	90CRI 3000K = 100%	2500lm = 83%
WH = 90%	90CRI 2700K = 96%	2000lm = 67%
BK = 54%		1500lm = 50%
		1000lm = 33%

P6RDL30930NCLZ10U • Narrow beam, 29W LED, 90CRI, 3000K

Candela Curves

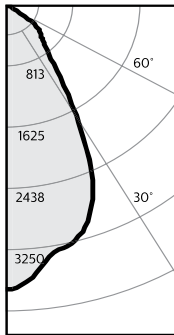

Report: **STMR-1416**

Output Lms:	2992 lms
Spacing Crit.:	0.92
Beam Angle:	58°
Input Watts ² :	28.8W
Efficacy:	103.9lm/w
CCT ³ :	3000K
CRI:	90min

Zonal lumens & percentages

Zone	Lumens	%Luminaire
0-30	1861	62.2%
0-40	2415	80.7%
0-60	2982	99.7%
0-90	2992	100.0%

Angle	Mean CP	Lms
0	3015	
5	2903	268
10	2670	
15	2585	722
20	2369	
25	1942	871
30	1357	
35	854	554
40	597	
45	489	378
50	399	
55	213	188
60	32	
65	5	8
70	3	
75	2	2
80	1	
85	0	0
90	0	

Single unit data

Height to lighted plane	Initial center beam foot-candles	Beam dia. (ft)*
5'	121	4.6'
6'	84	5.5'
7'	62	6.4'
8'	47	7.4'
9'	37	8.3'

* Beam diameter is where foot-candles drop to 50% of maximum.

Multiple unit data - RCR 2

Spacing on center	Initial center beam foot-candles	Watts per sq.ft.
5'	134.0	1.28
6'	88.0	0.84
7'	63.0	0.60
8'	53.0	0.50
9'	42.0	0.40

38'x38'x10' Room, Workplane 2.5' above floor, 80/50/20% Reflectances

Coefficients of utilization

	80%					70%		50%		30%		0%
	70	50	30	10	50	10	50	10	50	10	0	
Room Cavity Ratio	0	119	119	119	119	116	116	111	111	106	106	100
1	113	110	107	105	108	103	104	100	100	97	92	85
2	107	101	97	93	100	92	96	90	93	88	85	78
3	101	94	88	84	92	83	90	82	87	81	78	71
4	95	87	81	76	85	76	83	75	81	74	71	66
5	90	80	74	69	79	69	78	68	76	68	66	61
6	85	75	68	64	74	63	72	63	71	63	61	56
7	80	70	63	59	69	59	68	58	67	58	56	52
8	76	65	59	54	65	54	64	54	63	54	52	49
9	72	61	55	51	61	51	60	50	59	50	49	45
10	68	58	52	47	57	47	56	47	56	47	45	41

P6RDL30930MCLZ10U • Medium beam, 29W LED, 90CRI, 3000K

Candela Curves

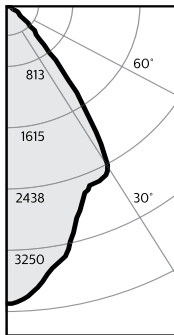

Report: **STMR-1415**

Output Lms:	3118 lms
Spacing Crit.:	0.9
Beam Angle:	66°
Input Watts ² :	28.8W
Efficacy:	108.3lm/w
CCT ³ :	3000K
CRI:	90min

Zonal lumens & percentages

Zone	Lumens	%Luminaire
0-30	1935	62.1%
0-40	2734	87.7%
0-60	3112	99.8%
0-90	3118	100.0%

Angle	Mean CP	Lms
0	3161	
5	3048	282
10	2789	
15	2498	698
20	2178	
25	2065	955
30	1942	
35	1298	799
40	650	
45	349	288
50	224	
55	93	90
60	13	
65	4	5
70	2	
75	1	2
80	1	
85	0	0
90	0	

Single unit data

Height to lighted plane	Initial center beam foot-candles	Beam dia. (ft)*
5'	126	4.5'
6'	88	5.4'
7'	65	6.3'
8'	49	7.2'
9'	39	8.1'

* Beam diameter is where foot-candles drop to 50% of maximum.

Multiple unit data - RCR 2

Spacing on center	Initial center beam foot-candles	Watts per sq.ft.
5'	140.0	1.28
6'	92.0	0.84
7'	66.0	0.60
8'	55.0	0.50
9'	44.0	0.40

38'x38'x10' Room, Workplane 2.5' above floor, 80/50/20% Reflectances

Coefficients of utilization

	80%					70%		50%		30%		0%
	70	50	30	10	50	10	50	10	50	10	0	
Room Cavity Ratio	0	119	119	119	119	116	116	111	111	106	106	100
1	113	110	107	105	108	103	104	100	100	97	92	85
2	107	101	97	93	100	92	96	90	93	88	85	78
3	101	94	88	84	92	83	90	82	87	81	78	71
4	95	87	81	76	85	76	83	75	81	74	71	66
5	90	80	74	69	79	69	78	68	76	68	66	61
6	85	75	68	64	74	63	72	63	71	63	61	56
7	80	70	63	59	69	59	68	58	67	58	56	52
8	76	65	59	54	65	54	64	54	63	54	52	49
9	72	61	55	51	61	51	60	50	59	50	49	45
10	68	58	52	47	57	47	56	47	56	47	45	41

1. Tested using absolute photometry as specified in LM79: IESNA Approved Method for the Electrical and Photometric Measurements of Solid-State Lighting Products.
 2. Wattage: controlled to within 5%
 3. Correlated Color Temperature: within specs as defined in ANSI/NEMA/ANSI C78.377-2008: Specifications for the Chromaticity of Solid State Lighting Products.



P6R LyteProfile 6"

Round Downlight & Lensed Wall Wash

Adjustment Factors

Finish	CRI/CCT	Lumens
CL = 100%	90CRI 4000K = 106%	3500lm = 117%
CC = 86%	90CRI 3500K = 104%	3000lm = 100%
CD = 91%	90CRI 3000K = 100%	2500lm = 83%
WH = 90%	90CRI 2700K = 96%	2000lm = 67%
BK = 54%		1500lm = 50%
		1000lm = 33%

P6RDL30930CLZ10U • Wide beam, 29W LED, 90CRI, 3000K

Candela Curves

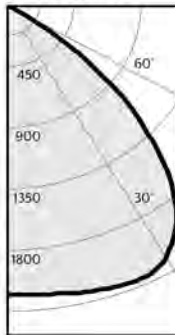

Report:
P6RDL30930CLZ10U.IES

Output Lms: 3411lms
Spacing Crit.: 1.42
Beam Angle: 91°
Input Watts: 29.4W
Efficacy: 116.0lm/w
CCT: 3500K
CRI: 90min

Zonal lumens & percentages

Zone	Lumens	%Luminaire
0-30	1397	41.0%
0-40	2328	68.2%
0-60	3396	99.6%
0-90	3411	100.0%

Angle	Mean CP	Lms
0	1624	
5	1626	
10	1641	156
15	1658	470
20	1672	771
25	1675	931
30	1626	771
35	1500	779
40	1303	779
45	1016	
50	696	
55	318	
60	33	289
65	9	
70	5	11
75	3	
80	1	3
85	0	
90	0	0

Single unit data

Height to lighted plane	Initial center beam foot-candles	Beam dia. (ft)*
5'	65	7.1'
6'	45	8.5'
7'	33	9.9'
8'	25	11.4'
9'	20	12.8'

* Beam diameter is where foot-candles drop to 50% of maximum.

Multiple unit data - RCR 2

Spacing on center	Initial center beam foot-candles	Watts per sq.ft.
5'	149.0	1.30
6'	98.0	0.86
7'	70.0	0.61
8'	58.0	0.51
9'	47.0	0.41

Coefficients of utilization

Ceiling	80%				70%				50%				30%				0%
	70	50	30	10	50	10	50	10	50	10	50	10	50	10	50	10	0
Wall	Zonal cavity method - Effective floor reflectance = 20%																
RCR	Zonal cavity method - Effective floor reflectance = 20%																
Room Cavity Ratio	0	119	119	119	119	116	116	111	111	106	106	100	100	100	100	100	
1	112	109	106	103	107	102	103	98	99	95	91	85	81	81	81	81	
2	105	99	94	90	97	89	94	87	86	77	72	67	65	65	65	65	
3	98	90	84	79	88	78	86	77	72	67	65	65	65	65	65	65	
4	91	82	75	69	80	69	78	68	67	67	65	65	65	65	65	65	
5	85	74	67	62	73	61	71	61	69	60	58	58	58	58	58	58	
6	79	68	60	55	67	55	65	54	64	54	52	52	52	52	52	52	
7	74	62	55	49	61	49	60	49	59	49	47	47	47	47	47	47	
8	69	57	50	45	56	45	55	44	54	44	42	42	42	42	42	42	
9	65	53	45	41	52	40	51	40	50	40	38	38	38	38	38	38	
10	61	49	42	37	48	37	47	37	46	37	35	35	35	35	35	35	

38'x38'x10' Room, Workplane 2.5' above floor, 80/50/20% Reflectances

P6RLW30930CLZ10U • Lensed Wall Wash, 29W LED, 90CRI, 3000K

Candela Curve

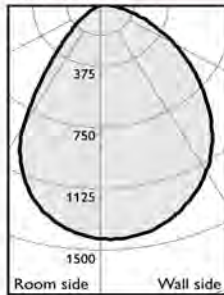

Report:
P6RLW30930CLZ10U.IES

Output Lms: 2517lms
Input Watts: 29.4W
Efficacy: 85.6lm/w
CCT: 3000K
CRI: 90min

Multiple unit data

Footcandles on wall

Distance from ceiling in feet	2' from wall		3' on ctr.	
	1	2	1	2
1	57	47	57	47
2	87	79	87	79
3	73	71	73	71
4	54	54	54	54
5	38	39	38	38
6	28	28	28	28
7	21	22	21	21
8	16	17	16	16
9	13	13	13	13
10	11	11	11	11
12	9	9	9	9
14	8	8	8	8

Multiple unit data

Footcandles on wall

Distance from ceiling in feet	3' from wall		3' on ctr.	
	1	2	1	2
1	25	24	25	24
2	49	48	49	48
3	55	55	55	55
4	50	51	50	50
5	41	42	41	41
6	32	33	32	32
7	26	26	26	26
8	20	21	20	20
9	16	17	16	16
10	14	14	14	14
12	11	12	11	11
14	10	10	10	10

Multiple unit data

Footcandles on wall

Distance from ceiling in feet	3' from wall		4' on ctr.	
	1	2	1	2
1	22	17	22	17
2	41	35	41	35
3	44	40	44	40
4	39	36	39	36
5	31	30	31	31
6	25	24	25	25
7	19	19	19	19
8	15	15	15	15
9	12	12	12	12
10	10	10	10	10
12	9	8	9	9
14	7	7	7	7

1. Tested using absolute photometry as specified in LM79: IESNA Approved Method for the Electrical and Photometric Measurements of Solid-State Lighting Products.
 2. Wattage: controlled to within 5%
 3. Correlated Color Temperature: within specs as defined in ANSI_NEMA_ANSI C78.377-2008: Specifications for the Chromaticity of Solid State Lighting Products.

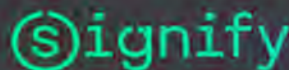

© 2022 Signify Holding. All rights reserved. The information provided herein is subject to change, without notice. Signify does not give any representation or warranty as to the accuracy or completeness of the information included herein and shall not be liable for any action in reliance thereon. The information presented in this document is not intended as any commercial offer and does not form part of any quotation or contract, unless otherwise agreed by Signify.

Signify North America Corporation
 400 Crossing Blvd, Suite 600
 Bridgewater, NJ 08807
 Telephone: 855-488-2216

Signify Canada Ltd.
 281 Hillmount Road,
 Markham, ON, Canada L3C 2S3
 Telephone: 800-668-9008

All trademarks are owned by Signify Holding or their respective owners.



Job Name : NEW TRAINING FACILITY ST. TAMMANY FIRE PROTECTION DISTRICT 1
Manufacturer : ASL
Model Number : TLZD-3

Type :
F4



TLZD-3
 Vanity

Model#
 TLZD-3

— Finish
 ORB



Properties

Base Construction	Cold-rolled Steel
Lens	Glass
Finish	ORB
Application	Vanity
Location	Damp
CRI	80
Life Hours	50,000
Light Source	Integrated LED

Specs

Voltage	DV 120V-277V (non dimming)
Lumens	/
Size	H:6.1" L:24" E:3.2"
CCT	2700K

Not seeing what you're looking for? Contact us! info@asllighting.com

© Copyright © 2025 ASL Lighting Inc. All rights reserved. [asllighting.com](http://www.asllighting.com)



Job Name : NEW TRAINING FACILITY ST. TAMMANY FIRE PROTECTION DISTRICT 1
Manufacturer : CHLORIDE
Model Number : VERWEM

Type :
EX



Project: _____
 Location: _____
 Cat. No: _____
 Type: _____
 Lamps: _____ Qty: _____
 Notes: _____

Chloride Value+ LED exit sign (VE) is an economically oriented exit that offers a low profile design, giving it stylish appeal suitable for any general purpose application. Utilizing long life high-performing LEDs, the VE is a reliable exit at a reasonable price.

LED exit sign – ordering guide

Model number	Letter color	Housing color	Operation
VERW	Red	White	AC only
VEGW	Green	White	AC only
VERWEM	Red	White	Emergency (Nicad battery)
VEGWEM	Green	White	Emergency (Nicad battery)

Note: All exit signs are universal (single face with an extra stencil face plate) Canopy provided on all exits.

Accessories (order separately)

- WG4 – Wire guard
- VEPMC – Pendant mount canopy, white, (requires stem assembly).
- PVS2 – Polycarbonate shield
- CXPA12W – Pendant assembly, Rigid canopy, 12" white stem (requires VEPMC).
- CXPAS12W – Pendant assembly, Swivel white canopy, 12" white stem (requires VEPMC).

Stem lengths available: 18", 24", 30", 36", 48", and 60"

Note:

All exit signs are universal (single face with an extra stencil face plate)
 Canopy provided on all exits.



Job Name : NEW TRAINING FACILITY ST. TAMMANY FIRE PROTECTION DISTRICT 1
Manufacturer : CHLORIDE
Model Number : VERWEM

Type :
EX

VE Value+ LED exit sign

Economy grade

Specifications

Codes and standards

- UL listed to Standard 924
- NFPA 70 (National Electric Code)
- NFPA 101 (Life Safety Code)
- California Energy Commission
- Suitable for damp locations

Lamps

- Bright red or green energy efficient LED lamps. Uniform 6" letter illumination (3/4" stroke).

Construction

- Thermoplastic (off-white) ABS housing
- UL 94 V-0.5VA Flame rated
- White housing only
- Low profile, snap-together quick mount design
- Universal wall/ceiling/end mounting
- Canopy not required for flat wall mount (electronics contained inside housing)

- Pop-out chevron directional indicators are easily removed when required
- Exit sign mounts to a standard 4" square outlet box (canopy provided)
- All exits are provided with an extra stencil face plate for double face sign applications

Battery

- VE Exits contain 6V maintenance free nickel cadmium battery with a service life of 8 to 10 years and a operating temperature range of 20°F (-7°C) to 104°F (40°C)
- Provides 90 minutes of emergency illumination

Electronics

- 120/277 VAC selectable input
- VE Units: AC Only
Input Power: 0.026A (120VAC)
Input Power: 0.012A (277VAC)
- VE Units: Emergency
Input Power: 0.033A (120VAC)
Input Power: 0.017A (277VAC)
- Low voltage disconnect, AC, and constant current charger

Warranty

- Three year limited warranty on electronics, LEDs, and battery

Dimensions

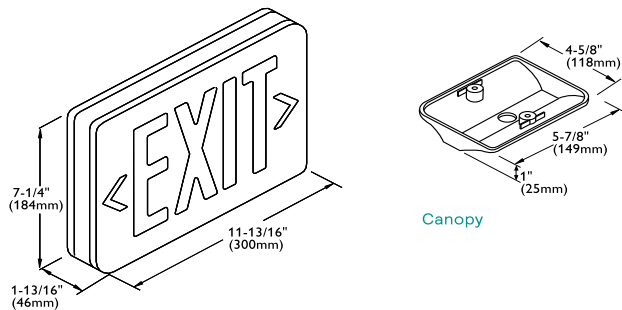

The information presented in this document is not intended as any commercial offer and does not form part of any quotation or contract.



© 2019 Signify Holding. All rights reserved. This document contains information relating to the product portfolio of Signify which information may be subject to change. No representation or warranty as to the accuracy or completeness of the information included herein is given and any liability for any action in reliance thereon is disclaimed. All trademarks are owned by Signify Holding or their respective owners.

Signify North America Corporation
 200 Franklin Square Drive,
 Somerset, NJ 08873
 Telephone 855-486-2216

Signify Canada Ltd.
 281 Hillmount Road,
 Markham, ON, Canada L6C 2S3
 Telephone 800-668-9008

Value+_exit_VE 04/19 page 2 of 2

www.chloride-lighting.com



Job Name : NEW TRAINING FACILITY ST. TAMMANY FIRE PROTECTION DISTRICT 1
Manufacturer : CHLORIDE
Model Number : VLTUR

Type :
EM

CHLORIDE
 by Signify

Exit/Emergency

Value+ LED

Emergency unit VLTU



Project: _____
 Location: _____
 Cat.No: _____
 Type: _____
 Lamps: _____ Qty: _____
 Notes: _____

Chloride Value+ LED emergency unit (VLTU) is an economically oriented emergency product. Featuring a low profile design with stylish appeal, the VLTU is an ideal choice for any general purpose application. The square lamp heads give it a pleasing appearance that is preferred over traditional units. Utilizing long life high-performing LEDs, the VLTU provides excellent emergency illumination at a reasonable price.

LED emergency unit – ordering guide

Model number	Voltage	Housing color	LED lamps	Remote capability
VLTU	3.6V	White	2 – 1W	None
VLTUR	3.6V	White	2 – 1W	2 – 1W or 1 – 2W heads

Accessories (order separately)

- WG4 – Wire guard

VLT1R



VLT2R



VLL1RGO



VLL2RGO



LED remote lamp heads – ordering guide

Model number	Voltage	Housing color	LED lamps	Application
VLT1R	3.6V	White	1 – 1W	Indoor
VLT2R	3.6V	White	2 – 1W	Indoor
VLL1RGO	3.6V, 6V, 9.6V, or 12V	Gray	1 – 1W	Outdoor
VLL2RGO	3.6V, 6V, 9.6V, or 12V	Gray	2 – 1W	Outdoor



VLTU Value+ LED emergency unit

Economy grade

Specifications

Codes and standards

- UL Listed to Standard 924
- cUL Listed
- NFPA 101 (Life Safety Code)
- NFPA 70 (National Electric Code)
- Suitable for damp locations

Lamps

- VLTU/VLTUR emergency lighting units contain two 3.6VDC - 1W longlife LED lamp sources (6000K)
- Fully adjustable LED lamp heads provide 200 lumens.

Power consumption

- VLTU (120V)—0.6W
- VLTUR (277V)—0.78W

Construction

- Thermoplastic (white) ABS housing
- UL 94V-O flame rating
- Wall or ceiling mounted - provisions for surface mounted conduit to top of wall mounted unit
- Back plate keyhole slots are easily removable knockouts for securing to 4" jbox for easy mounting

Battery

- Maintenance-free sealed 3.6V nickel cadmium
- Manual test switch and LED light indicator
- Supplies emergency illumination for a minimum of 90 minutes
- Operating temperature range: 10°C (50°F) to 40°C (104°F)

Electronics

- 120/277VAC, 60Hz dual voltage selectable input
- Surge protected, solid state circuitry
- Charging systems are complete with low voltage disconnect (prevents deep discharge of battery), battery lockout (prevents discharge of battery during installation), and brownout protection

Remote capability

- VLTUR unit provides enough remote capability to supply 3.6V DC power to 2-1W (VLT1R) LED remote lamp heads or 1-2W (VLT2R) LED remote lamp head.
- VLTUR unit provides enough remote capability to supply 3.6V DC power to 2-1W (VLL1RGO) LED remote lamps heads or 1-2W (VLL2RGO) LED remote lamp head.

Warranty

- Three year limited warranty on electronics, LEDs, and battery.

Dimensions

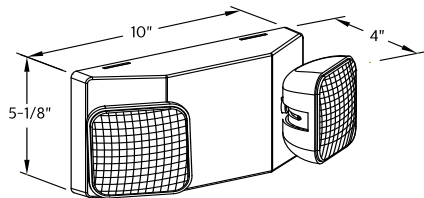

Spacing information

NFPA 101 requires 1.0 foot-candle average and 0.1 foot-candle minimum with a 40:1 maximum/minimum ratio. The corridor used is 100 feet long, 9 feet ceiling with a 6 feet wide walkway and 3 feet path of egress. The reflectance is 80% ceiling, 50% walls and 20% floors. The fixture mounting height is 7.5 feet.

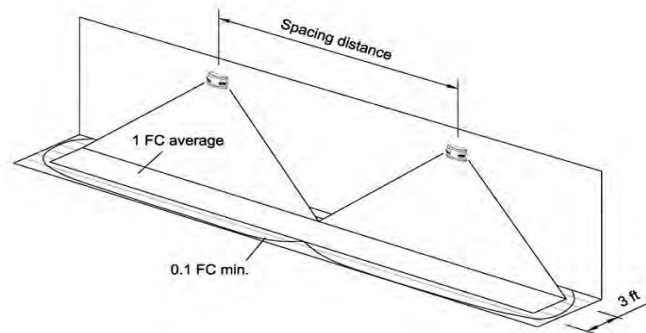

Model	Spacing distance	Lumen output
VLTU, VLTUR	24 feet	200 lm



VLTU Value+ LED emergency unit

Economy grade

Indoor LED remote lamp heads

- VLT1R single LED remote lamp head contains a 3.6VDC 1W LED light source
- VLT2R dual LED remote lamp heads, each contain a 3.6VDC 1W LED light source
- VLT1R and VLT2R indoor LED remote lamp heads have an off-white finish
- Each VLT1R and VLT2R indoor LED remote lamp heads can accept power only from a VLTUR unit, VLTCR2R combo or VLTCG2R combo

VLT1R dimensions

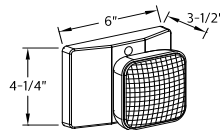

VLT2R dimensions

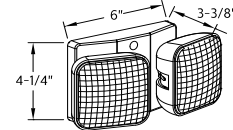

Outdoor LED remote lamp heads

- VLL1RGO single outdoor LED remote lamp head contains a 1W LED light source
- VLL2RGO dual outdoor LED remote lamp heads, each contain a 1W LED light source
- VLL1RGO and VLL2RGO power source can be either a 3.6, 6, 9.6 or 12VDC
- VLL1RGO and VLL2RGO outdoor LED remote lamp heads have a gray finish

VLL1RGO dimension

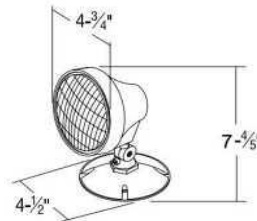

VLL2RGO dimensions

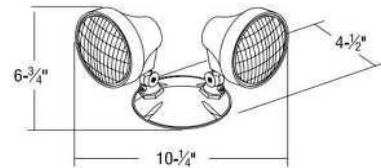

© 2019 Signify Holding. All rights reserved. This document may be subject to change. No representation or warranty as to the accuracy or completeness of the information included herein is given and any liability for any action in reliance thereon is disclaimed. All trademarks are owned by Signify Holding or their respective owners.

Value+_emerg_unit_VLTU www.chloride-lighting.com 11/18 page 3 of 3

Signify North America Corporation
200 Franklin Square Drive,
Somerset, NJ 08873
Telephone 855-486-2216

Signify Canada Ltd.
281 Hillmount Road,
Markham, ON, Canada L6C 2S3
Telephone 800-668-9008



Job Name : NEW TRAINING FACILITY ST. TAMMANY FIRE PROTECTION DISTRICT 1
Manufacturer : STONCO
Model Number : ASW25-SCT-G1-8-PCB-BW

Type :
S1E

Stonco

by Signify

Wall Mount

Adjustable Slim Wall Pack

ASW 25W and 75W



Adjustable Slim Wall Pack features a discreet design that will complement any building exterior. Two sizes are available, with three wattage and three CCT selectable options each.

Project: _____
 Location: _____
 Cat. No: _____
 Type: _____
 Lamps: _____ Qty: _____
 Notes: _____

Ordering guide

example: ASW25-SCT-G1-8-PCB-BW

Family	CCT	Generation	Input Voltage	Controls	Finish
<input type="text"/>	<input type="text" value="SCT"/>	<input type="text" value="G1"/>	<input type="text" value="8"/>	<input type="text" value="PCB"/>	<input type="text" value="BW"/>
ASW25 Adjustable Slim Wall Pack – Selectable wattage 15W/20W/25W ASW75 Adjustable Slim Wall Pack – Selectable wattage 45W/60W/75W	SCT Field Selectable – 3CCT 3000K, 4000K & 5000K	G1 Generation 1	8 UNV	PCB Photocontrol	BW Brown Grey

Specifications

Housing

Die-cast aluminum housing with UV stabilized polycarbonate lens mounted with stainless steel hardware.

IP Rating

LED light engine is weather proof rated IP65.

Electrical

Electrical Driver efficiency (>90% at full load). Available in 120-277V. IP65 compliant driver. RoHS compliant. Standard surge protection 4kV.

Optical System and Controls

Three color temperature options 3000K, 4000K (Default), 5000K. 70 CRI. Photo control button (PCB) included as standard.

Mounting

Offers a 0 to 90° tilt option. Mounts to standard 3 1/2" to 4" square and octagonal or 4 inch round electrical junction boxes, using a simple flip cover design for easy access.

Light Engine

System efficacy up to 120lm/W

Lumen output options:

15W: 1800lm, **20W:** 2400lm, **25W:** 3000lm
45W: 5400lm, **60W:** 7200lm, **75W:** 9000lm

Listings

cETL listed. Suitable for Wet Locations. Suitable for use in ambient from -40°C to 40°C (-40°F to 104°F). All versions are DLC 5.1 Premium qualified.

Finish

Powder coat finish, standard color is Brown Grey (BW).

Limited Warranty

Luminaires are all covered by a 5-year limited warranty. See signify.com/warranties for details.





ASW Adjustable Slim Wall Pack

25W and 75W

Dimensions

ASW25

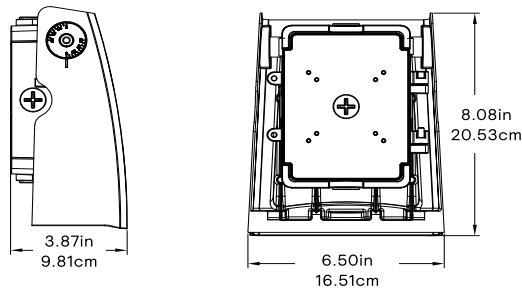

ASW75

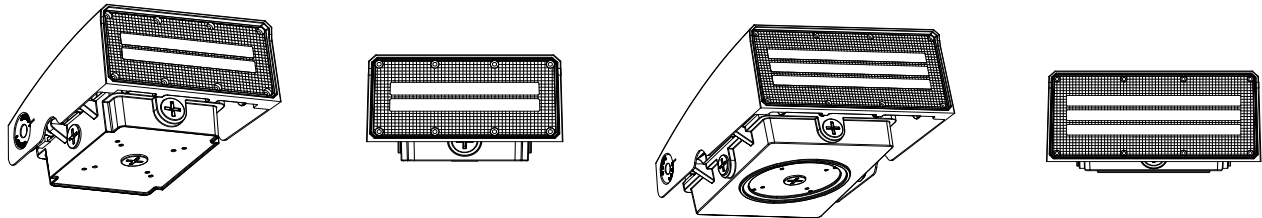
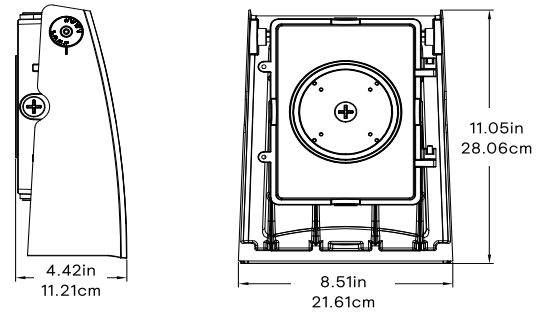

LED Wattage and Lumen Values

Ordering Codes	Total LEDs	System Current (mA)	Color Temp. (K)	Average System Wattage ¹	Lumen Output ^{1,2}	Efficacy (LPW)	Weight (kg)
ASW25-SCT-G1-8-PCB-BW	52	250	3000/4000/5000	15W/20W/25W	1800/2400/3000	120	1.32
ASW75-SCT-G1-8-PCB-BW	100	750	3000/4000/5000	45W/60W/75W	5400/7200/9000	120	2.4

1. Wattage and lumen output may vary due to LED manufacturer forward volt specification and ambient temperature. Wattage shown is average for 120V through 277V input. Measured wattage may vary due to variation in input voltage.
 2. Lumen values based on photometric tests performed in compliance with IESNA LM-79.

Predicted Lumen Depreciation Data

Ordering Codes	Ambient Temperature °C	L ₇₀ Per TM-21 ^{1,2}	Lumen Maintenance % @ 60,000hrs
ASW25-SCT-G1-8-PCB-BW	-40°C to 40°C	L ₇₀ > 50,000hrs @25C	86%
ASW75-SCT-G1-8-PCB-BW	-40°C to 40°C	L ₇₀ > 50,000hrs @25C	86%

1. Predicted performance derived from LED manufacturer's data and engineering design estimates, based on IESNA LM-80 methodology. Actual experience may vary due to field application conditions.
 2. L₇₀ is the predicted time when LED performance depreciates to 70% of initial lumen output.



© 2022 Signify Holding. All rights reserved. The information provided herein is subject to change, without notice. Signify does not give any representation or warranty as to the accuracy or completeness of the information included herein and shall not be liable for any action in reliance thereon. The information presented in this document is not intended as any commercial offer and does not form part of any quotation or contract, unless otherwise agreed by Signify.

Signify North America Corporation
 400 Crossing Blvd, Suite 600
 Bridgewater, NJ 08807
 Telephone: 855-486-2216

Signify Canada Ltd.
 281 Hillmount Road,
 Markham, ON, Canada L6C 2S3
 Telephone: 800-668-9008

All trademarks are owned by Signify Holding or their respective owners.



Transmittal

Wells Keown Associates
301 Plauche St
Harahan LA 70123
Phone: (504) 733-0301
From: Rich Hayes

Project **New Training Facility - St. Tammany Fire Protection District No. 1**

Quote# WK25-44042

Location Slidell LA

To DAMMON ENGINEERS INC
554 Old Spanish Trail
Slidell LA 70458
Contact:

ATTACHED WE ARE SENDING YOU 1 COPY OF THE FOLLOWING ITEM:

- | | | |
|-----------------------------------|--|--------|
| <input type="checkbox"/> Drawings | <input type="checkbox"/> Specifications | Other: |
| <input type="checkbox"/> Prints | <input type="checkbox"/> Information | |
| <input type="checkbox"/> Plans | <input checked="" type="checkbox"/> Submittals | |

THESE ARE TRANSMITTED FOR:

- | | | |
|--|---|---------------------------------|
| <input checked="" type="checkbox"/> Prior Approval | <input type="checkbox"/> Resubmittal for Approval | <input type="checkbox"/> Record |
| <input type="checkbox"/> Approval | <input type="checkbox"/> Corrections | Bids due on: |
| <input type="checkbox"/> Approval as Submitted | <input type="checkbox"/> Your Use | Other: |
| <input type="checkbox"/> Approval as Noted | <input type="checkbox"/> Review and Comment | |

Type	MFG	Part
F1	Metalux	24CZ2-40-UNV-L840-CD1-U
F2	Metalux	22CZ2-32-UNV-L840-CD1-U
F2A	Metalux	22CZ2-32-UNV-L840-CD1-U DF-22W-U
F3	Halo Commercial	HC615D010 HM60525930 61MDCWF
F4	Royal Pacific Lighting	4909-BN-4
EX	SURE-LITES	APX7RG
EM	SURE-LITES	SEL50
S1E	Beghelli	MUR-SA-WHT-CL



Job Name:

New Training Facility - St. Tammany Fire Protection District No. 1
 Architect: DAMMON ENGINEERS INC (Slidell)
 Engineer: DAMMON ENGINEERS INC (Slidell)

Catalog Number:

24CZ2-40-UNV-L840-CD1-U

Notes:

Type:

F1

WK25-44042

Project		Catalog #		Type	
Prepared by		Notes		Date	



Metalux

Cruze ST 24CZ2

2' x 4' LED Specification Grade Troffer

Typical Applications

Office • Education • Healthcare • Hospitality • Retail

Interactive Menu

- Order Information [page 2](#)
- Photometric Data [page 3](#)
- Control Solutions [page 5](#)
- VividTune™ Color Tuning Solutions [page 6](#)
- BioUp - Melanopic Lighting [page 7](#)
- Product Warranty

Product Certification



Product Features



Top Product Features

- Latch-less design provides clean architectural look
- BioUp melanopic lighting options for 30% circadian boost and earn WELL Building Standard points
- VividTune CCT tuning options from 3000K-5000K or 2700K-6500K
- Designers delight - ribbed, smooth and round perforated lens options
- High performance efficacy up to 167 lm/W
- Integrated sensor systems - occupancy, daylight and IoT connectivity
- Options to meet Buy American and other domestic preference requirements

Dimensional and Mounting Details

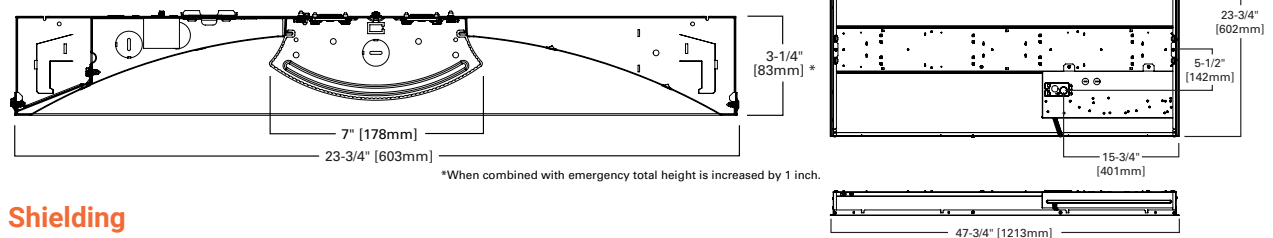

Shielding

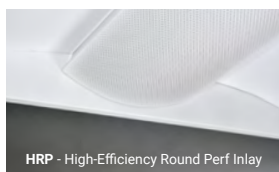

See ordering information for more shielding options.

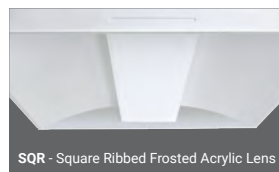

Ceiling Compatibility

G Grid/Lay-in Standard	G Concealed T	G Slot Grid	Ceiling Type	Trim Type
			Exposed Grid	Standard
			Concealed T	Standard
			Slot Grid	Standard
			Flange	Standard *

* See Drywall Frame Kit Accessory in Ordering Information Section



Job Name:
New Training Facility - St. Tammany Fire Protection District No. 1
Architect: DAMMON ENGINEERS INC (Slidell)
Engineer: DAMMON ENGINEERS INC (Slidell)

Catalog Number:
24CZ2-40-UNV-L840-CD1-U

Type:
F1

Notes:

WK25-44042

Metalux

24CZ2 LED

Order Information

SAMPLE ORDER NUMBER: **24CZ2-40-UNV-L840-CD1-U**

	24CZ2	40
--	--------------	-----------

Domestic Preferences ⁽¹⁾	Rating	Series	Air	Lumen Level / Efficacy Option		
[Blank]=Standard BAA=Buy American Act TAA=Trade Agreements Act	[Blank]=Standard ATW-SW4=Chicago Rated	24CZ2-2x4 Cruze ST	[Blank]=Standard A=Air (Vented) ⁽²⁾	Standard [Blank] 30=3000 Lumens 35=3500 Lumens 40=4000 Lumens 45=4500 Lumens 50=5000 Lumens 55=5500 Lumens 60=6000 Lumens ⁽³⁾ 65=6500 Lumens ^{(3),(4)}	High Efficacy [HE] 30HE=3000 Lumens 35HE=3500 Lumens 40HE=4000 Lumens 45HE=4500 Lumens 50HE=5000 Lumens 55HE=5500 Lumens 60HE=6000 Lumens ⁽³⁾ 65HE=6500 Lumens ^{(3),(4)} 70HE=7000 Lumens ^{(3),(4)} 75HE=7500 Lumens ^{(3),(4)}	Very High Efficacy [VHE] 30VHE=3000 Lumens ⁽³⁾ 35VHE=3500 Lumens ⁽³⁾ 40VHE=4000 Lumens ⁽³⁾ 45VHE=4500 Lumens ⁽³⁾ 50VHE=5000 Lumens ⁽³⁾ 55VHE=5500 Lumens ⁽³⁾ 60VHE=6000 Lumens ⁽³⁾ 65VHE=6500 Lumens ^{(3),(4)} 70VHE=7000 Lumens ^{(3),(4)} 75VHE=7500 Lumens ^{(3),(4)} 80VHE=8000 Lumens ^{(3),(4)} 85VHE=8500 Lumens ^{(3),(4)} 90VHE=9000 Lumens ^{(3),(4)} 95VHE=9500 Lumens ^{(3),(4)} 100VHE=10000 Lumens ^{(3),(4),(5)} 110VHE=11000 Lumens ^{(3),(4),(5)} 120VHE=12000 Lumens ^{(3),(4),(5)} 130VHE=13000 Lumens ^{(3),(4),(5)} 150VHE=15000 Lumens ^{(3),(4),(5)} 170VHE=17000 Lumens ^{(3),(4),(5)}
Notes <small>(1) Only product configurations with these designated prefixes are built to be compliant with the Buy American Act of 1933 (BAA) or Trade Agreements Act of 1979 (TAA), respectively. Please refer to DOMESTIC PREFERENCES website for more information. Components shipped separately may be separately analyzed under domestic preference requirements.</small>			Notes <small>(2) Air version is intended for air return through plenum. See air return data table for air flow volumes. Air option not available with ATW-SW4. Air requires "PAF" option.</small>	Notes <small>(3) VividTune white tuning and BioUp static and dynamic options are not available with these lumen/efficacy selections. (4) Available with CD or HCD drivers only. (5) Requires 2 CD-1 drivers above 100VHE. (6) W2D Dali dimming BioUp not available with these options.</small>		

	UNV	
--	------------	--

Shielding	Voltage ⁽⁷⁾	Options	Emergency Options
[Blank]=Ribbed Frosted Acrylic Lens (standard) S=Smooth Frosted Acrylic Lens HRP=High-Efficiency Round Perf Inlay SQR=Square Ribbed Frosted Acrylic Lens	UNV=Universal Voltage 120-277 347V=347 Volt ⁽⁸⁾	GL=Single Element Fuse GM=Double Element Fuse PAF= Painted After Fabrication	[Blank]=No emergency EL7W=7-watt 120V-277V emergency battery pack ⁽⁹⁾ EL10W=10-watt 120V-277V emergency battery pack ⁽⁹⁾ EL14W=14-watt 120V-277V emergency battery pack ⁽⁹⁾ EL10WSD=10W emergency battery pack with self-diagnostic installed ^{(9),(11)} EL14WSD=14W emergency battery pack with self-diagnostic installed ^{(9),(11)} ETRD=Emergency Transfer Relay with dimming control ⁽¹⁰⁾ RRU=LVS Controls Emergency Transfer Relay with dimming control ⁽¹⁰⁾ UEL7W=UL924 Listed luminaire, 7-watt, 120V-277V emergency battery pack ^{(13),(9)} UEL14W=UL924 Listed luminaire, 14-watt 120V-277V emergency battery pack ^{(13),(9)} UEL10WSD=Bodine 10W emergency battery pack with self diagnostic installed ^{(13),(9),(12)} UETRD=UL924 Listed luminaire, Emergency Transfer Relay with dimming control ^{(13),(10)} URRU=UL924 Listed luminaire, LVS Controls Emergency Transfer Relay with dimming control ^{(13),(10)}
	Notes <small>(7) Products also available in non-US voltages and frequencies for international markets. (8) Some 347V versions require a transformer. Total wattage will increase by 2 watts if used.</small>		Notes <small>(9) Factory installed with integral test switch/indicator/laser test. For approximate delivered lumens multiply the lumens per watt of the desired fixture by the wattage of the emergency battery pack (100 lm/W x 7=700 lumens). IES-format photometry for luminaire under emergency operation available. Battery option increases total height by 1 inch. (10) Used to bypass local control during outage. Must be used in conjunction with UL 1008 device (provided by others). Devices are universal voltage (UNV). 347 not available. (11) EL10WSD and EL14WSD not available with 347V. (12) UEL10WSD not available with 347V. (13) Cannot be used with BioUp options.</small>

L840		CD
-------------	--	-----------

CRI/CCT	Flex	Driver Type
L830=80CRI, 3000K L835=80CRI, 3500K L840=80CRI, 4000K L850=80CRI, 5000K L930=90CRI, 3000K L935=90CRI, 3500K L940=90CRI, 4000K L950=90CRI, 5000K L83050=80CRI 3000K-5000K White Tuning ⁽¹⁵⁾ L93050=90CRI 3000K-5000K White Tuning ⁽¹⁵⁾ L82765=80CRI 2700K-6500K White Tuning ⁽¹⁵⁾ L92765=90CRI 2700K-6500K White Tuning ⁽¹⁵⁾ B35=BioUp Static 3500K ⁽¹⁶⁾ B40=BioUp Static 4000K ⁽¹⁶⁾ B50=BioUp Static 5000K ⁽¹⁶⁾ B2750=BioUp Tunable 2700K-5000K ⁽¹⁷⁾	[Blank]=No Flex A3/8-4/18GDIM=3/8" Flex with 0-10V Dimming Leads A3/8-2/18G=3/8" Flex with line and common A3/8-5/18GDIM=Flex with 0-10V Dimming leads and Blue for alternate wiring. See below for details. A3/8-4/18GDIM series notes: Factory installed dimming option 3/8" flexible metal conduit with 2-#18 power and ground wires and 2-#18 UL-listed jacketed 0-10V +/- control wires. Meets UL 66, 83, 1479, 1569, 1581, 2556, NEC® 250.118, 300.22(C), 392, 396, 330, 501, 502, 503, 530, 504, 505, 518, 520, 530, 645, 72; Federal Specification A-A-59544 (formerly J-C-308); all applicable OSHA and HUD Requirements. UL Classified 1-, 2-, and 3-hour through penetration with applicable fire stop product (not included). May be surface mounted, fished and/or embedded in plaster. Cable tray and approved raceway rated, install per NEC®; Environmental Air-Handling Space Installation per NEC® 300.22(C).	CD=0-10V Driver (10%-100% Dimming) ⁽²⁴⁾ HCD=0-10V Driver (1%-100% Dimming) ⁽²⁵⁾ SLTD=DALI Driver (5%-100% Dimming) SLTHD=DALI Driver (1%-100% Dimming) SD=Step Dimming Driver (50%-100% Dimming) LH=Lutron HiLume 1% EcoSystems (LDE1) ⁽⁹⁾ W2A=White Tuning, 2 ch, Analog 0-10V (1%-100% Dimming) ^{(18),(26)} W2D=White Tuning, DALI Type 8 (1%-100% Dimming) ⁽¹⁹⁾
Notes <small>(15) VividTune provides correlated color temperatures (CCT) between 3000K (warm) to 5000K (cool) or 2700K (warm) to 6500K (cool). Must be used in conjunction with W2A driver only. Must be used with two (2) 10V dimming control channels, 1 cct, 1 intensity. May be combined with Wavelinx sensor control systems. (16) BioUp Static to be used with HCD driver. (17) BioUp Tunable provides correlated color temperatures (CCT) between 2700K (warm) to 5000K (cool). Must be used with W2A for two channel 0-10V Control) or W2D (for 2 channel DALI Control) driver. See BioUp page for more information.</small>	Flexible Metal Conduit Options <small>Flex options available for 0-10V dimming control, DALI dimming control, emergency and night light functions. 72-inch factory-installed and pre-wired to driver, fitted to luminaire housing access plate with 90° enclosed FMC connector. Not all options may be combined and installation ratings vary by type. See online configurator for all flex options. A3/8-4/18GDIM series notes: Factory installed dimming option 3/8" flexible metal conduit with 2-#18 power and ground wires and 2-#18 UL-listed jacketed 0-10V +/- control wires. Meets UL 66, 83, 1479, 1569, 1581, 2556, NEC® 250.118, 300.22(C), 392, 396, 330, 501, 502, 503, 530, 504, 505, 518, 520, 530, 645, 72; Federal Specification A-A-59544 (formerly J-C-308); all applicable OSHA and HUD Requirements. UL Classified 1-, 2-, and 3-hour through penetration with applicable fire stop product (not included). May be surface mounted, fished and/or embedded in plaster. Cable tray and approved raceway rated, install per NEC®; Environmental Air-Handling Space Installation per NEC® 300.22(C).</small>	Notes <small>(18) W2A used with two (2) 10V dimming control channels - cct and intensity. (19) W2D for use with BioUp options only. White tuning CCT between 2700K and 5000K. Must be used with DALI controls; one address to control two channels - intensity and CCT. May not be used with sensing systems. For Emergency options ONLY EL10WSD can be used. (26) When selecting 0-10V driver with integrated Sensing System a 0-10V driver might be substituted with another type. Integrated options must be used in conjunction with the associated system and may not be compatible with other options or accessories. Please refer to the following: (F) Consult Marketplace Options - Lutron system pages for additional details and compatibility. Compatible only with driver series shown, and may require two or more drivers. Requires field commissioning to operate or dim. Contact Lutron at www.lutron.com.</small>



Job Name:

New Training Facility - St. Tammany Fire Protection District No. 1
 Architect: DAMMON ENGINEERS INC (Slidell)
 Engineer: DAMMON ENGINEERS INC (Slidell)

Catalog Number:

24CZ2-40-UNV-L840-CD1-U

Notes:

Type:

F1

WK25-44042

Metalux

24CZ2 LED

Order Information

CONTINUED

1		U	
Number of Drivers	Integrated Sensing Systems ⁽²¹⁾	Packaging	Accessories (order separately) ⁽²⁵⁾
1=1 Driver 2=2 Drivers ⁽²⁰⁾	<p>[Blank]=No Sensor</p> <p>WLS (formerly WAB)=WaveLinX LITE Wireless Sensor, Occupancy w/ photocell, Independent & Networked ^{(23), (B)}</p> <p>WPS (formerly WAA)=WaveLinX PRO Wireless Sensor, Occupancy w/ photocell, Networked ^{(23), (A)}</p> <p>WLN=WaveLinX LITE Wireless Control Node, without sensor ^{(23), (B)}</p> <p>WPN=WaveLinX PRO Wireless Control Node, without sensor ^{(23), (A)}</p>	<p>U=Unit Pack</p> <p>PAL=Job Pack, out of carton</p> <p>PALC=Job Pack, in carton</p>	<p>CZ2-EQCLIP-U-PK="CZ2" Earthquake Clip Kit (4 clips per bag kit) ⁽²⁴⁾</p> <p>DF-24W-U=2' x 4' Drywall Frame Kit</p> <p>SK-24-WS=2' x 4' Shallow Surface Mount Kit</p> <p>SK-24-WT=2' x 4' Tall Surface Mount Kit</p>
<p>Notes</p> <p>(20) See lumen limitation notes for applications requiring 2 drivers or use online configurator. When combined with emergency total height is increased by 1 inch.</p>	<p>Notes</p> <p>(21) Matching width lens band on other side of sensor band may be supplied for symmetrical appearance. Required for use with sensor and emergency combination. Add "D" to sensor ordering as shown - WPSD, WLSD. (22) WPS sensor and WPN node to be used with CD, HCD or WZA driver. (23) WLS Sensor and WLN node to be used with CD or HCD driver.</p> <p>Integrated options must be used in conjunction with the associated system and may not be compatible with other options or accessories. Please refer to the following: (A) Consult WaveLinX PRO system pages for additional details and compatibility. (B) Consult WaveLinX LITE system pages for additional details and compatibility.</p>		<p>Notes</p> <p>(24) An EQ Grid Clip is recommended for all 9/16" ceiling systems. Four required per fixture. (25) Accessories sold separately will be separately analyzed under domestic preference requirements. Consult factory for further information.</p>

Product Specifications

Construction

- Die formed of code gauge prime cold rolled steel with full length die-formed stiffeners
- Unibody endplates attached with interlocking tabs and screws
- Hemmed side flanges
- Four auxiliary fixture end suspension points
- Integral Grid-lock feature for endplates for added safety
- Optional earthquake clips available

Integrated Controls

- Standard with 0-10V dimming driver (10% standard, 1% optional)
- Integrated WaveLinX options provide wireless individual fixture control and enable code compliance, increased energy savings, grouping of fixtures, and connection to WaveLinX control systems
- DALI 2.0, Lutron, and step-dimming available

LED and Light Engine

- LED's available in 3000K, 3500K, 4000K, or 5000K at 80 CRI minimum and 90 CRI minimum
- Color accuracy ≤ 3 -Step MacAdam ellipse (SDCM)
- TM21 life at 60,000 hours up to L90 and calculated L70 exceeds 203,000 hrs.
- Drivers available in 120-277V and 347V
- Tunable white options available with Cooper Lighting Solutions' VividTune
- BioUp melanopic lighting options available in static or tunable white

Emergency Options

- 120V-277V integral emergency battery pack comes in 7-watts, 10-watt, or 14-watts
- Self-diagnostic emergency battery available in 10 or watts (NFPA 101® Life Safety Code®)
- Constant power to the LED system for controlled, predictable discharge
- Integrated test switch/indicator light visible from floor
- Min. 90-minute backup period for code compliance
- Integral emergency transfer relay available for generator equipped power systems

Shielding

- Ribbed acrylic frosted lens standard
- Optional smooth acrylic frosted lens (S)
- Optional square ribbed frosted acrylic lens (SQR)
- Optional High-Efficiency Round Perf Inlay (HRP)
- Replacement lenses available, contact factory
- Lens is acrylic with features on the face and sides to optimize the direct and indirect lighting contributions for improved glare and efficacy

Compliance

- IC rated for insulation contact
- cULus listed for damp locations
- UL924 luminaire listing available, see Emergency Options
- RoHS compliant
- Tested to IESNA LM-79 and LM-80
- Stated life tested to TM21 standards
- Can be used for State of California Title 24 high efficacy luminaire

Warranty

- Five-year limited warranty standard. Optional ten year limited warranty available.

Finish

- Multistage, iron phosphate pretreatment
- 90% reflective, matte white enamel finish
- Full fixture housing pre-painted matte white (choose PAF option for "Paint after Fabrication")

Photometric Data

[View IES files](#)

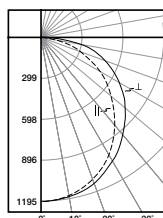

24CZ2-35-UNV-L830-CD1-U
 Dimming Driver
 Linear LED 3000K
 Spacing criterion: (H) 1.22 x mounting height,
 (L) 1.28 x mounting height
 Lumens: 3618
 Input Watts: 30.1W
 Efficacy: 120.2 LPW
 Test Report: 24CZ2-35-UNV-L830-CD1-U.IES

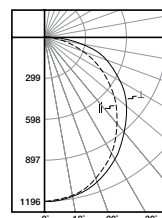

24CZ2-35HE-UNV-L830-CD1-U
 Dimming Driver
 Linear LED 3000K
 Spacing criterion: (H) 1.21 x mounting height,
 (L) 1.27 x mounting height
 Lumens: 3562
 Input Watts: 26.9W
 Efficacy: 132.4 LPW
 Test Report: 24CZ2-35HE-UNV-L830-CD1-U.IES



Job Name:

New Training Facility - St. Tammany Fire Protection District No. 1
 Architect: DAMMON ENGINEERS INC (Slidell)
 Engineer: DAMMON ENGINEERS INC (Slidell)

Catalog Number:
 24CZ2-40-UNV-L840-CD1-U

Notes:

Type:

F1

WK25-44042

Metalux

24CZ2 LED

Energy and Performance Data

Standard Efficacy Versions – Single Row of LEDs
 Default CCT/Lumen Setting: 3500K/Med

Catalog Number	Lumens	Watts	lm/W
24CZ2-30-UNV-L835-CD1-U	3028	22.4	135
24CZ2-35-UNV-L835-CD1-U	3633	27.3	133
24CZ2-40-UNV-L835-CD1-U	4178	30.4	137
24CZ2-45-UNV-L835-CD1-U	4602	35.0	132
24CZ2-50-UNV-L835-CD1-U	5049	39.6	128
24CZ2-55-UNV-L835-CD1-U	5571	41.1	135
24CZ2-60-UNV-L835-CD1-U	6056	46.3	131
24CZ2-65-UNV-L835-CD1-U	6601	50.1	132

High Efficacy Versions – Two Rows of LEDs
 Default CCT/Lumen Setting: 3500K/Med

Catalog Number	Lumens	Watts	lm/W
24CZ2-30HE-UNV-L835-CD1-U	3100	22.3	139
24CZ2-35HE-UNV-L835-CD1-U	3685	27.0	137
24CZ2-40HE-UNV-L835-CD1-U	4144	30.7	135
24CZ2-45HE-UNV-L835-CD1-U	4712	35.3	134
24CZ2-50HE-UNV-L835-CD1-U	5164	38.6	134
24CZ2-55HE-UNV-L835-CD1-U	5722	43.5	132
24CZ2-60HE-UNV-L835-CD1-U	6182	44.1	140
24CZ2-65HE-UNV-L835-CD1-U	6777	48.9	139
24CZ2-70HE-UNV-L835-CD1-U	7218	49.3	146
24CZ2-75HE-UNV-L835-CD1-U	7787	55.4	141

Very High Efficacy Versions – Three Rows of LEDs
 Default CCT/Lumen Setting: 3500K/Med

Catalog Number	Lumens	Watts	lm/W
24CZ2-30VHE-UNV-L835-CD1-U	3011	20.4	148
24CZ2-35VHE-UNV-L835-CD1-U	3526	22.8	155
24CZ2-40VHE-UNV-L835-CD1-U	4042	26.2	154
24CZ2-45VHE-UNV-L835-CD1-U	4559	29.6	154
24CZ2-50VHE-UNV-L835-CD1-U	5064	32.7	155
24CZ2-55VHE-UNV-L835-CD1-U	5570	36.1	154
24CZ2-60VHE-UNV-L835-CD1-U	6055	38.7	157
24CZ2-65VHE-UNV-L835-CD1-U	6565	42.2	156
24CZ2-70VHE-UNV-L835-CD1-U	7059	45.7	155
24CZ2-75VHE-UNV-L835-CD1-U	7662	49.9	154
24CZ2-80VHE-UNV-L835-CD1-U	8128	53.8	151
24CZ2-85VHE-UNV-L835-CD1-U	8600	57.9	149
24CZ2-90VHE-UNV-L835-CD1-U	9053	61.8	147
24CZ2-95VHE-UNV-L835-CD1-U	9521	65.6	145
24CZ2-100VHE-UNV-L835-CD1-U	10191	69.6	146
24CZ2-110VHE-UNV-L835-CD2-U	11098	77.4	143
24CZ2-120VHE-UNV-L835-CD2-U	12211	83.6	146
24CZ2-130VHE-UNV-L835-CD2-U	13271	90.7	146
24CZ2-150VHE-UNV-L835-CD2-U	15006	104.2	144
24CZ2-170VHE-UNV-L835-CD2-U	17021	123.4	138

Shielding

Lumen Adjustment Factors		
S	HRP	SQR
1.05	0.81	0.96

Lumen Calculator

CCT Multiplier	80 CRI	90 CRI ⁽¹⁾	BioUp Static
3000K	0.965	0.827	-
3500K	1.000	0.847	0.912
4000K	1.019	0.856	0.899
5000K	1.019	0.909	0.879

Notes: (1) Input wattages for 90 CRI versions may vary. Refer to published IES-format photometry or LM-79 reports for more details.

Example of Lumen Adjustment Calculation

24CZ2-40-UNV-L835-CD1-U at 90CRI at 3500K
 Lumen Adjustment Factor = 0.845
 Total Light Output =
 4,196 lm x 0.845 = 3,546 lm
 Efficacy = $\frac{3,546 \text{ lm}}{36.2W} = 98 \text{ lm/W}$

Lumen Maintenance

Version	TM-21 Lumen Maintenance (60,000 hours) ⁽²⁾	Theoretical L70 (Hours) ⁽³⁾
Standard	> 87%	> 151,000
High Efficiency	> 90%	> 203,000
Very High Efficiency	> 90%	> 203,000

Notes: (2) Supported by IES TM-21 standards. (3) Theoretical values represent estimations commonly used; however, refer to the IES position on LED Product Lifetime Prediction, IES PS-10-18, that explains proper use of IES TM-21 and LM-80.

Load Data (Stock Product)

Thd	6%
Power Factor	0.99
Weight (lbs.)	16
Low Temp. Start	-20°C

Shipping Data

Catalog No.	Wt.	Pallet 49"L x 52"W x 46"H
2' x 4'	20.4 lbs.	28

Air Return Volume

Negative Static Pressure (Inches H ₂ O)	Return Air Volume (CFM)
0.05	75
0.1	103
0.2	153
0.25	177
0.3	191
0.45	234



Job Name:

New Training Facility - St. Tammany Fire Protection District No. 1
 Architect: DAMMON ENGINEERS INC (Slidell)
 Engineer: DAMMON ENGINEERS INC (Slidell)

Catalog Number:

24CZ2-40-UNV-L840-CD1-U

Notes:

Type:

F1

WK25-44042

Metalux

24CZ2 LED

Control Solutions

- WaveLinX LITE wireless
- WaveLinX PRO wireless
- WaveLinX CAT wired
- WaveLinX Wired



The Cruze ST with WaveLinX offers no-hassle lighting control with multiple luminaire level control solutions.



WaveLinX PRO is a wireless lighting control solution, for connected spaces, that significantly reduces a building's energy consumption. From a single floor to an entire campus, WaveLinX PRO connects more than lighting assets; it shares aggregated sensor data with the WaveLinX CORE platform and other building systems, so building owners can improve operations, spaces environment, and tenants' experience. WaveLinX PRO offers a rich portfolio of wireless devices, WaveLinX PRO-enabled luminaires, and an intuitive WaveLinX mobile app for office, education, warehouse, and parking garage applications.



WaveLinX LITE is a cost effective, wireless digital lighting control solution, with out-of-the-box functionality, that saves energy and meets code. It's designed for applications that require occupancy-based, daylighting, or manual light control. Customize installations for office, education, warehouse and parking garages using the secure, simple mobile app.

Integrated Sensor Coverage Pattern

TOP VIEW:

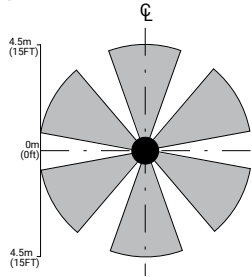

SIDE VIEW:

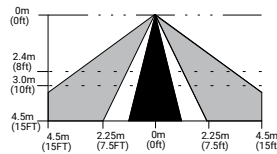

Note: Installation of integrated sensors within 3-ft (1m) of HVAC air vents is not recommended. The pattern shown is intended solely as a general guide and is not to scale.

With Integrated WaveLinX Sensor

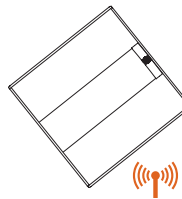

With Integrated WaveLinX Node

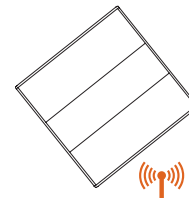

Add a hidden WaveLinX sensor node (WPN, WLN) to your space lighting design!

Allows to:

- Keeps luminaire aesthetics
- Connect fixtures without the realstate to include sensor option such as downlights
- Connect sealed fixtures without a standard sensor option such as products for clinical space.

Integrated Controls Options

Option	Out of the Box Functionality	Luminaire Level Lighting Control (LLC)	Automatic Dimming Photocell	Occupancy Sensing	CCT Control
WLS	X	X	X	X	
WLN		X			
WPS		X	X	X	X
WPN		X			X

Systems comparison chart

Cooper Lighting Solutions provides many lighting system solutions designed to satisfy code requirements and meet the unique needs of any project.



Luminaire with standalone sensor

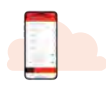

Standalone Spaces WaveLinX LITE



Standalone Spaces WaveLinX CAT



Networked Spaces WaveLinX PRO



Enterprise WaveLinX CORE

	Luminaire with standalone sensor	Standalone Spaces WaveLinX LITE	Standalone Spaces WaveLinX CAT	Networked Spaces WaveLinX PRO	Enterprise WaveLinX CORE
Occupancy	Yes	Yes	Yes	Yes	Yes
Daylighting	Yes	Yes	Yes	Yes	Yes
Wallstations	-	Yes	Yes	Yes	Yes
Gateways	-	-	-	1 WAC	300 WACs
Devices (MAX)	-	40 per Area (1120 per space)	40 per Area	200 per WAC2	32,500 per CORE Enterprise
Software	-	WaveLinX LITE Mobile App	WaveLinX CAT Mobile App	WaveLinX Mobile App	CORE
Areas	-	28 per Space	Unlimited	50 per WAC2	up to 3,000
Zones	-	16 per Area	16 per Area	16 per Area	up to 9,000
Scheduling	-	-	-	Local	Global
VividTune™	-	-	-	Yes	Yes
Plug-Load Control	-	Yes	Yes	Yes	Yes
Low-Voltage Power	-	-	Yes	Yes	Yes
Integration	-	-	-	-	BACnet, API
Dashboards	-	-	-	-	Energy, Occupancy
Configuration	-	Installer	Installer	Technician	Technician / IT

Note: WaveLinX utilizes scenes to allow users to change an area's fixtures Correlated Color Temperature (CCT) and intensity using commissioned manual wireless wallstation scene control. To enable CCT adjustments through WaveLinX, include WPS or WPN devices in addition to VividTune or BioUp technologies for integrated fixture control.



Job Name:

New Training Facility - St. Tammany Fire Protection District No. 1
 Architect: DAMMON ENGINEERS INC (Slidell)
 Engineer: DAMMON ENGINEERS INC (Slidell)

Catalog Number:

24CZ2-40-UNV-L840-CD1-U

Notes:

Type:

F1

WK25-44042

Metalux

24CZ2 LED



24 Cruze ST LED with VividTune Tunable White

VividTune tunable white luminaires from Cooper Lighting Solutions deliver high-quality light in a broad range of continuously variable color temperatures and intensities. Create a dynamic environment by adjusting the ambient light warmer or cooler to influence mood, support the task at hand, or create a dramatic ambience. The ability to control correlated color temperature and intensity separately using simple controls is the next evolution of LED lighting for the commercial, educational, healthcare and hospitality space. The unparalleled flexibility and number of available lighting environments enable users to find the right light with tunable white.

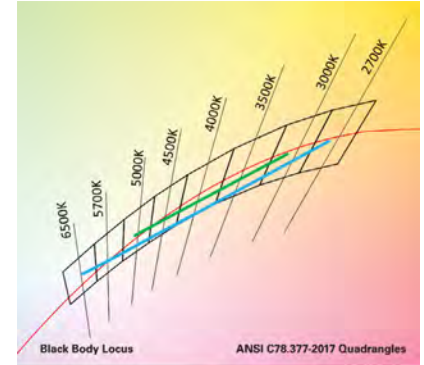

— 3000K - 5000K
 — 2700K - 6500K

Energy and Performance Data

Tunable White - Lumen Adjustment Factors						
CCT	VividTune 3000K-5000K		VividTune 2700K-6500K		BioUp Tunable White 2700K-5000K	
	80 CRI	90 CRI	80 CRI	90 CRI	CRI	Lumen Adjustment
2700K	-	-	0.903	0.771	95	0.938
3000K	0.929	0.765	0.928	0.801	94	0.929
3500K	0.983	0.836	0.961	0.842	90	0.912
4000K	1.033	0.903	0.981	0.868	87	0.899
4500K	1.042	0.918	0.999	0.891	85	0.890
5000K	1.042	0.918	1.013	0.909	84	0.879
6500K	-	-	1.028	0.933	-	-

2' x 4' Cruze ST LED - Example of Approximate Lumen Calculation				
	Standard Catalog #	VividTune 80 CRI Catalog #	VividTune 90 CRI Catalog #	BioUp Tunable White
CCT Setting	24CZ2-40HE-UNV-L835-CD1-U	24CZ2-40HE-UNV-L83050-W2A1-U	24CZ2-40HE-UNV-L93050-W2A1-U	24CZ2-40HE-UNV-B2750-W2A1-U
2700K	-	3638	3106	3779
3000K	-	3641	2998	3743
3500K	4029	3853	3275	3674
4000K	-	4046	3537	3622
4500K	-	4084	3599	3586
5000K	-	4084	3599	3541
6500K	-	4142	3579	-

Controlling VividTune and BioUp Tunable White

From wall dimmers to wireless controls, tunable white luminaires are compatible with industry standard 0-10V and DALI controls. One channel to control intensity (brightness) and a second channel to adjust CCT.

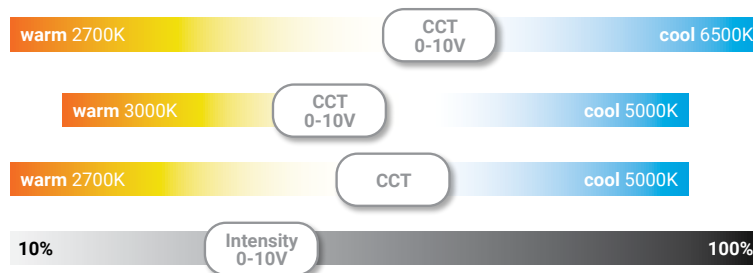

Example of Lumen Adjustment Calculation

24CZ2-40HE-UNV-L83050-W2A1-U at 80 CRI tuned to 3500K

Adjusted Lumen = published lm x adjusted lm factor

Adjusted Lumen = 4029 x 0.956

Adjusted Lumen = 3853 lm

** Lumen adjustment factors are for reference and may be different for each product selected. Refer to IES files for actual performance data on each.*



Job Name:

New Training Facility - St. Tammany Fire Protection District No. 1
 Architect: DAMMON ENGINEERS INC (Slidell)
 Engineer: DAMMON ENGINEERS INC (Slidell)

Catalog Number:

24CZ2-40-UNV-L840-CD1-U

Notes:

Type:

F1

WK25-44042

Metalux

24CZ2 LED

Proven Research. Industry Recognized.

BioUp
 Melanopic Lighting



See better



Feel better



Function better



See [BioUp brochure](#) for more details

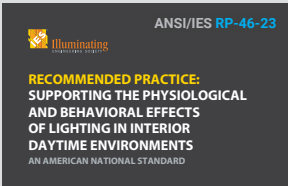

ANSI/IES RP-46-23 / TM18 published March 2024 based on over 40 years of research.

"...circadian clock synchronization is paramount to the body's efficient and appropriate functioning." – TM18



BioUp solutions maximize WELL points for Circadian Lighting Design (L03):

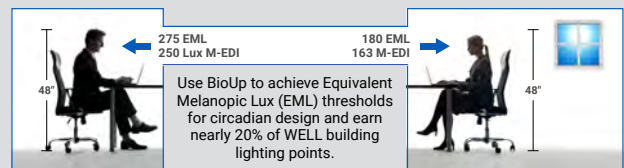

MDER, M-EDI and EML are key metrics used to quantify non-visual performance of indoor lighting systems.

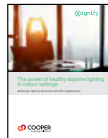

See [BioUp white paper](#) for more details

30% boost Biological impact
 compared to traditional LED sources

CCT	LED MDER ~83 CRI	BioUp Static		BioUp Dynamic	
		MDER	CRI	MDER	CRI
2700K	0.44	-	-	0.43	95
3000K	0.49	-	-	0.54	94
3500K	0.56	0.71	90	0.71	90
4000K	0.64	0.84	87	0.82	87
5000K	0.77	0.98	84	0.98	84

BioUp enhances the LED spectrum with cyan light at 475nm increasing the biological impact of the light to enhance our circadian rhythm which regulates our sleep/wake cycle, daytime engagement, and mood – **all without distorting visual color impression.**

MDER - Melanopic Daylight Efficacy Ratio (MDER) measures the amount of light stimulating to the melanopsin receptors.

Standard 4000K LED
 MDER = .62

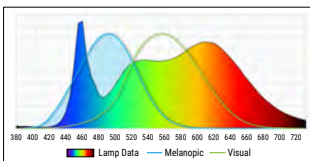

BioUp 4000K LED
 MDER = .82

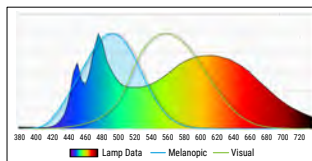

Static (non-tunable)

Static BioUp is used when simple Melanopic Lighting is desired at all times.

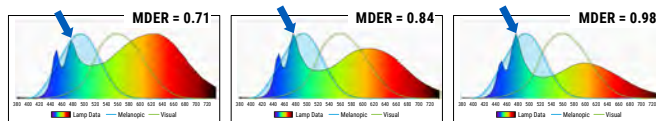

3500K or 4000K or 5000K

Cyan light component always present



> no CCT control needed

Arrow in graph shows BioUp spectrum boost is at 475nm where non-visual biological response is enhanced.

Dynamic - (Tunable)

Dynamic BioUp is used when Melanopic Lighting is desired to adjust during the day.

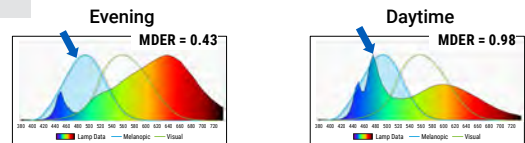

Warmer CCT **Without** Cyan content ← → Cooler Light **With** Cyan content

2700K - 5000K



> Control with Wavelinx, 2ch 0-10V, or DALI



Cooper Lighting Solutions
 1121 Highway 74 South
 Peachtree City, GA 30269
 P. 770-486-4800
 www.cooperlighting.com

© 2024 Cooper Lighting Solutions
 All Rights Reserved.

Specifications and dimensions
 subject to change without notice.

PS519306EN page 7
 December 9, 2024 1:23 PM



Job Name:

New Training Facility - St. Tammany Fire Protection District No. 1
 Architect: DAMMON ENGINEERS INC (Slidell)
 Engineer: DAMMON ENGINEERS INC (Slidell)

Catalog Number:
 22CZ2-32-UNV-L840-CD1-U

Notes:

Type:

F2

WK25-44042

Project		Catalog #		Type	
Prepared by		Notes		Date	



Metalux

Cruze ST 22CZ2

2' x 2' LED Specification Grade Troffer

Typical Applications

Office • Education • Healthcare • Hospitality • Retail

Interactive Menu

- Order Information page 2
- Photometric Data page 3
- Control Solutions page 5
- VividTune™ Color Tuning Solutions page 6
- BioUp - Melanopic Lighting page 7
- Product Warranty

Product Certification



Product Features



Top Product Features

- Latch-less design provides clean architectural look
- BioUp melanopic lighting options for 30% circadian boost and earn WELL Building Standard points
- VividTune CCT tuning options from 3000K-5000K or 2700K-6500K
- Designers delight - ribbed, smooth and round perforated lens options
- High performance efficacy up to 151 lm/W
- Integrated sensor systems - occupancy, daylight and IoT connectivity
- Options to meet Buy American and other domestic preference requirements

Dimensional and Mounting Details

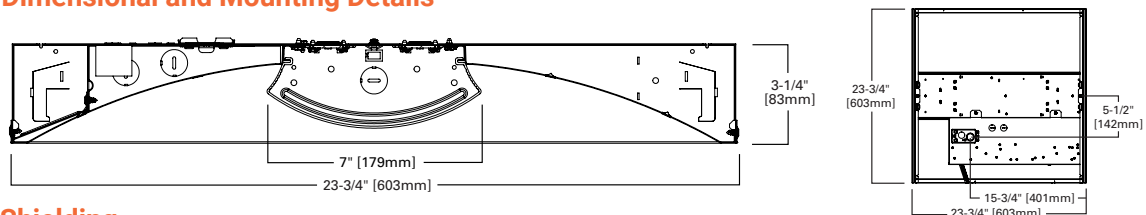

Shielding

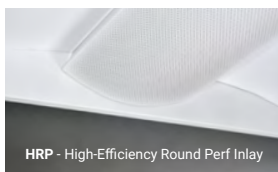

HRP - High-Efficiency Round Perf Inlay



SQR - Square Ribbed Frosted Acrylic Lens

See ordering information for more shielding options.

Ceiling Compatibility

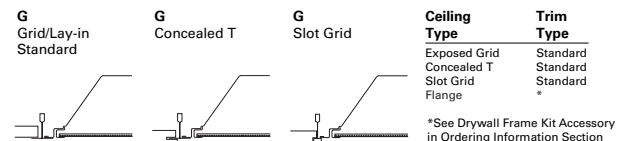



Job Name:
New Training Facility - St. Tammany Fire Protection District No. 1
Architect: DAMMON ENGINEERS INC (Slidell)
Engineer: DAMMON ENGINEERS INC (Slidell)

Catalog Number:
22CZ2-32-UNV-L840-CD1-U

Type:
F2

Notes:

WK25-44042

Metalux

22CZ2 LED

Order Information

SAMPLE ORDER NUMBER: 22CZ2-32UNV-L840-CD1-U

Domestic Preferences ⁽¹⁾	Rating	Series	Air	Lumen Level / Efficacy Option			Shielding	Voltage ⁽⁵⁾	Options
[Blank]=Standard BAA=Buy American Act TAA=Trade Agreements Act	[Blank]=Standard ATW-SW4= Chicago Rated	22CZ2-2x2 Cruze ST	[Blank]=Standard A=Air (Vented) ⁽²⁾	Standard [Blank] 20=2000 Lumens ⁽⁴⁾ 24=2400 Lumens ⁽⁴⁾ 32=3200 Lumens ⁽⁶⁾ 39=3900 Lumens ⁽⁶⁾ 44=4400 Lumens ⁽⁶⁾	High Efficacy [HE] ^{(4),(5)} 20HE=2000 Lumens 24HE=2400 Lumens 29HE=2900 Lumens 34HE=3400 Lumens 39HE=3900 Lumens 44HE=4400 Lumens	Very High Efficacy [VHE] 20VHE=2000 Lumens 24VHE=2400 Lumens 29VHE=2900 Lumens 34VHE=3400 Lumens 39VHE=3900 Lumens 44VHE=4400 Lumens 50VHE=5000 Lumens 55VHE=5500 Lumens 60VHE=6000 Lumens ⁽⁵⁾ 65VHE=6500 Lumens ⁽⁵⁾ 70VHE=7000 Lumens ^{(3),(6)} 75VHE=7500 Lumens ^{(3),(6)} 80VHE=8000 Lumens ^{(3),(6)} 85VHE=8500 Lumens ^{(3),(6)} 90VHE=9000 Lumens ^{(3),(6)} 95VHE=9500 Lumens ^{(3),(6)} 100VHE=10000 Lumens ^{(3),(6)} 110VHE=11000 Lumens ^{(3),(6)}	[Blank]=Ribbed Frosted Acrylic Lens (standard) S=Smooth Frosted Acrylic Lens HRP=High- Efficiency Round Perf Inlay SQR=Square Ribbed Frosted Acrylic Lens	UNV=Universal Voltage 120-277 347V=347 Volt	GL=Single Element Fuse GM=Double Element Fuse PAF=Painted After Fabrication
Notes (1) Only product configurations with these designated prefixes are built to be compliant with the Buy American Act of 1933 (BAA) or Trade Agreements Act of 1979 (TAA), respectively. Please refer to DOMESTIC PREFERENCES website for more information. Components shipped separately may be separately analyzed under domestic preference requirements.			Notes (2) Air version is intended for air return through plenum. See air return data table for air flow volumes. Air option not available with ATW-SW4. Air requires "PAF" option.	Notes (3) VividTune white tuning and BioUp static and dynamic options are not available with these lumen/efficacy selections. (4) BioUp lumen option. (5) VividTune lumen option. (6) Available with CD and HCD drivers only.				Notes (5) Products also available in non-US voltages and frequencies for international markets.	

L840

Emergency Options	CRI/CCT	Flex
[Blank]=No emergency EL7W=7-watt 120V-277V emergency battery pack ⁽⁶⁾ EL10W=10-watt 120V-277V emergency battery pack ⁽⁶⁾ EL14W=14-watt 120V-277V emergency battery pack ⁽⁶⁾ EL10WSD=10W emergency battery pack with self-diagnostic installed ^{(6),(8)} EL14WSD=14W emergency battery pack with self-diagnostic installed ^{(6),(8)} ETRD=Emergency Transfer Relay with dimming control ⁽⁷⁾ RRU=LVS Controls Emergency Transfer Relay with dimming control ⁽⁷⁾ UEL7W=UL924 Listed luminaire, 7-watt, 120V-277V emergency battery pack ^{(6),(10)} UEL14W=UL924 Listed luminaire, 14-watt 120V-277V emergency battery pack ^{(6),(10)} UEL10WSD=Bodine 10W emergency battery pack with self diagnostic installed ^{(6),(8),(10)} UETRD=UL924 Listed luminaire, Emergency Transfer Relay with dimming control ^{(7),(10)} URRU=UL924 Listed luminaire, LVS Controls Emergency Transfer Relay with dimming control ^{(7),(10)}	L830=80CRI, 3000K L835=80CRI, 3500K L840=80CRI, 4000K L850=80CRI, 5000K L930=90CRI, 3000K L935=90CRI, 3500K L940=90CRI, 4000K L950=90CRI, 5000K L83050=80CRI 3000K-5000K White Tuning ⁽¹²⁾ L93050=90CRI 3000K-5000K White Tuning ⁽¹²⁾ L82765=80CRI 2700K-6500K White Tuning ⁽¹²⁾ L92765=90CRI 2700K-6500K White Tuning ⁽¹²⁾ B35=BioUp Static 3500K ⁽¹³⁾ B40=BioUp Static 4000K ⁽¹³⁾ B50=BioUp Static 5000K ⁽¹³⁾ B2750=BioUp Tunable 2700K-5000K ⁽¹⁴⁾	[Blank]=No Flex A3/8-4/18GDIM=3/8" Flex with 0-10V Dimming Leads A3/8-2/18G=3/8" Flex with line and common A3/8-5/18GDIM=Flex with 0-10V Dimming leads and Blue for alternate wiring. See below for details. Flexible Metal Conduit Options Flex options available for 0-10V dimming control, DALI dimming control, emergency and night light functions. 72-inch factory-installed and pre-wired to driver, fitted to luminaire housing access plate with 90° enclosed FMC connector. Not all options may be combined and installation ratings vary by type. See online configurator for all flex options. A3/8-4/18GDIM series notes: Factory installed dimming option 3/8" flexible metal conduit with 2-#18 power and ground wires and 2-#18 UL-listed jacketed 0-10V +/- control wires. Meets UL 66, 83, 1479, 1569, 1581, 2556, NEC® 250.118, 300.22(C), 392, 396, 399, 501, 502, 503, 530, 504, 505, 518, 520, 530, 645, 72; Federal Specification A-A-59544 (formerly J-C-308); all applicable OSHA and HUD Requirements. UL Classified 1-, 2-, and 3-hour through penetration with applicable fire stop product (not included). May be surface mounted, fished and/or embedded in plaster. Cable tray and approved raceway rated, install per NEC®; Environmental Air-Handling Space Installation per NEC® 300.22(C).
Notes (6) Factory installed with integral test switch/indicator/laser test. For approximate delivered lumens multiply the lumens per watt of the desired fixture by the wattage of the emergency battery pack (100 lm/W x 7=700 lumens). IES-format photometry for luminaire under emergency operation available. Battery option increases total height by 1 inch. (7) Used to bypass local control during outage. Must be used in conjunction with UL1008 device (provided by others). Devices are universal voltage (UNV), 347 not available. (8) EL10WSD and EL14WSD not available with 347V. (9) UEL10WSD not available with 347V. (10) Cannot be used with BioUp options.	Notes (12) VividTune provides correlated color temperatures (CCT) between 3000K (warm) to 5000K (cool) or 2700K (warm) to 6500K (cool). Must be used in conjunction with W2A driver only. Must be used with two (2) 10V dimming control channels, 1 cct, 1 intensity. May be combined with Wavelinx sensor control systems. (13) BioUp Static to be used with HCD driver. (14) BioUp Tunable provides correlated color temperatures (CCT) between 2700K (warm) to 5000K (cool). Must be used with W2A (for two channel 0-10V Control) or W2D (for 2 channel DALI Control) driver. See BioUp page for more information.	

CD

1

U

Driver Type	No. of Drivers	Integrated Sensing Systems ⁽¹⁷⁾	Packaging	Accessories (order separately) ⁽²¹⁾
CD=0-10V Driver (10%-100% Dimming) ⁽²²⁾ HCD=0-10V Driver (1%-100% Dimming) ⁽²²⁾ SLTD=DALI Driver (5%-100% Dimming) SLTHD=DALI Driver (1%-100% Dimming) SD=Step Dimming Driver (50%-100% Dimming) LH=Lutron HiLume 1% EcoSystems (LDE1) ⁽⁷⁾ W2A=White Tuning, 2 cc, Analog 0-10V (1%-100% Dimming) ^{(15),(22)} W2D=White Tuning, DALI Type 8 (1%-100% Dimming) ⁽¹⁶⁾	1=1 Driver	[Blank]=No Sensor WLS (formerly WAB)=WaveLinx LITE Wireless Sensor, Occupancy w/ photocell, Independent & Networked ^{(18),(19)} WPS (formerly WAA)=WaveLinx PRO Wireless Sensor, Occupancy w/ photocell, Networked ^{(18),(19)} WLN=WaveLinx LITE Wireless Control Node, without sensor ^{(18),(19)} WPN=WaveLinx PRO Wireless Control Node, without sensor ^{(18),(19)}	U=Unit Pack PAL=Job Pack, out of carton PALC=Job Pack, in carton	CZ2-EQCLIP-U-PK="CZ2" Earthquake Clip Kit (4 clips per bag kit) ⁽²⁰⁾ DF-22-W=2 x 2 Drywall Frame Kit SK-22-WS=2 x 2 Shallow Mount Kit SK-22-WT=2 x 2 Tall Surface Mount Kit
Notes (15) W2A used with two (2) 10V dimming control channels - CCT and intensity. (16) W2D for use with BioUp options only. White tuning CCT between 2700K and 5000K. Must be used with DALI controls; one address to control two channels - intensity and CCT. May not be used with sensing systems. For Emergency options ONLY EL10WSD can be used. (22) When selecting 0-10V driver with Integrated Sensing System a 0-10V driver might be substituted with another type. Integrated options must be used in conjunction with the associated system and may not be compatible with other options or accessories. Please refer to the following: (F) Consult Marketplace Options - Lutron system pages for additional details and compatibility. Compatible only with driver series shown, and may require two or more drivers. Requires field commissioning to operate or dim. Contact Lutron at www.lutron.com.		Notes (17) Matching width lens band on other side of sensor band may be supplied for symmetrical appearance. Required for use with sensor and emergency combination. Add "0" to sensor ordering as shown - WPSD, WLS-D. (18) WPS sensor and WPN node to be used with CD, HCD or W2A driver. (19) WLS sensor and WLN node to be used with CD or HCD driver. Integrated options must be used in conjunction with the associated system and may not be compatible with other options or accessories. Please refer to the following: (A) Consult WaveLinx PRO system pages for additional details and compatibility. (B) Consult WaveLinx LITE system pages for additional details and compatibility.		Notes (20) An EQ Grid Clip is recommended for all 9/16" ceiling systems. Four required per fixture. (21) Accessories sold separately will be separately analyzed under domestic preference requirements. Consult factory for further information.



**Job Name:**

New Training Facility - St. Tammany Fire Protection
District No. 1
Architect: DAMMON ENGINEERS INC (Slidell)
Engineer: DAMMON ENGINEERS INC (Slidell)

Catalog Number:

22CZ2-32-UNV-L840-CD1-U

Notes:

Type:**F2**

WK25-44042

Metalux**22CZ2 LED****Product Specifications****Construction**

- Die formed of code gauge prime cold rolled steel with full length die-formed stiffeners
- Unibody endplates attached with interlocking tabs and screws
- Hemmed side flanges
- Four auxiliary fixture end suspension points
- Integral Grid-lock feature for endplates for added safety
- Optional earthquake clips available

Integrated Controls

- Standard with 0-10V dimming driver (10% standard, 1% optional)
- Integrated WaveLinX options provide wireless individual fixture control and enable code compliance, increased energy savings, grouping of fixtures, and connection to WaveLinX control systems
- DALI 2.0, Lutron, and step-dimming available

LED and Light Engine

- LED's available in 3000K, 3500K, 4000K, or 5000K at 80 CRI minimum and 90 CRI minimum
- Color accuracy ≤ 3 -Step MacAdam ellipse (SDCM)
- TM21 life at 60,000 hours up to L90 and calculated L70 exceeds 203,000 hrs.
- Drivers available in 120-277V and 347V
- Tunable white options available with Cooper Lighting Solutions' VividTune
- BioUp melanopic lighting options available in static or tunable white

Emergency Battery Options

- 120V-277V integral emergency battery pack comes in 7-watts, 10-watt, or 14-watts
- Self-diagnostic emergency battery available in 10 or 14-watts (NFPA 101@ Life Safety Code®)
- Constant power to the LED system for controlled, predictable discharge
- Integrated test switch/indicator light visible from floor
- Min. 90-minute backup period for code compliance
- Integral emergency transfer relay available for generator equipped power systems

Shielding

- Ribbed acrylic frosted lens standard
- Optional smooth acrylic frosted lens (S)
- Optional square ribbed frosted acrylic lens (SQR)
- Optional High-Efficiency Round Perf Inlay (HRP)
- Replacement lenses available, contact factory
- Lens is acrylic with features on the face and sides to optimize the direct and indirect lighting contributions for improved glare and efficacy

Compliance

- IC rated for insulation contact
- cULus listed for damp locations
- RoHS compliant
- Tested to IESNA LM-79 and LM-80
- Stated life tested to TM21 standards
- Can be used for State of California Title 24 high efficacy luminaire

Warranty

- Five-year limited warranty standard. Optional ten year limited warranty available.

Finish

- Multistage, iron phosphate pretreatment
- 90% reflective, matte white enamel finish
- Full fixture housing pre-painted matte white (choose PAF option for "Paint after Fabrication")

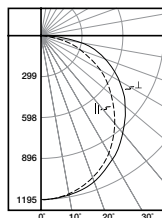
Photometric Data
[View IES files](#)
**22CZ2-24-UNV-L830-CD1-U**

Dimming Driver
Linear LED 3000K
Spacing criterion: (H) 1.2 x mounting height, (L) 1.28 x mounting height
Lumens: 2437
Input Watts: 21.9W
Efficacy: 111.3 LPW
Test Report: 22CZ2-24-UNV-L830-CD1-U.IES

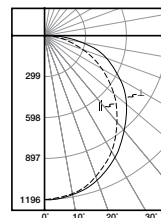
**22CZ2-24HE-UNV-L830-CD1-U**

Dimming Driver
Linear LED 3000K
Spacing criterion: (H) 1.19 x mounting height, (L) 1.27 x mounting height
Lumens: 2402
Input Watts: 19.2W
Efficacy: 125.1 LPW
Test Report: 14CZ2-29-UNV-L830-CD1-U.IES

**Job Name:**

New Training Facility - St. Tammany Fire Protection
District No. 1
Architect: DAMMON ENGINEERS INC (Slidell)
Engineer: DAMMON ENGINEERS INC (Slidell)

Catalog Number:

22CZ2-32-UNV-L840-CD1-U

Notes:

Type:**F2**

WK25-44042

Metalux**22CZ2 LED****Energy and Performance Data**

Standard Efficacy Versions – Single Row of LEDs
Default CCT/Lumen Setting: 3500K/Med

Catalog Number	Lumens	Watts	lm/W
22CZ2-20-UNV-L835-CD1-U	2142	16.2	132
22CZ2-24-UNV-L835-CD1-U	2454	18.5	133
22CZ2-32-UNV-L835-CD1-U	3272	24.2	135
22CZ2-39-UNV-L835-CD1-U	3953	31	128
22CZ2-44-UNV-L835-CD1-U	4462	33	134

High Efficacy Versions – Two Rows of LEDs

Catalog Number	Lumens	Watts	lm/W
22CZ2-20HE-UNV-L835-CD1-U	2030	15.0	135
22CZ2-24HE-UNV-L835-CD1-U	2474	18.1	137
22CZ2-29HE-UNV-L835-CD1-U	2982	20.9	143
22CZ2-34HE-UNV-L835-CD1-U	3426	24.3	141
22CZ2-39HE-UNV-L835-CD1-U	3997	28.5	140
22CZ2-44HE-UNV-L835-CD1-U	4567	32.8	139

Very High Efficacy Versions – Three Rows of LEDs

Catalog Number	Lumens	Watts	lm/W
22CZ2-20VHE-UNV-L835-CD1-U	2008	14.2	141
22CZ2-24VHE-UNV-L835-CD1-U	2501	17.5	143
22CZ2-29VHE-UNV-L835-CD1-U	3114	21.7	144
22CZ2-34VHE-UNV-L835-CD1-U	3598	25.1	143
22CZ2-39VHE-UNV-L835-CD1-U	4078	28.6	143
22CZ2-44VHE-UNV-L835-CD1-U	4620	32.6	142
22CZ2-50VHE-UNV-L835-CD1-U	5095	36.2	141
22CZ2-55VHE-UNV-L835-CD1-U	5530	39.4	140
22CZ2-60VHE-UNV-L835-CD1-U	6110	44.1	139
22CZ2-65VHE-UNV-L835-CD1-U	6559	47.9	137
22CZ2-70VHE-UNV-L835-CD1-U	7017	50.3	140
22CZ2-75VHE-UNV-L835-CD1-U	7557	54.7	138
22CZ2-80VHE-UNV-L835-CD1-U	8092	59.1	137
22CZ2-85VHE-UNV-L835-CD1-U	8615	63.6	136
22CZ2-90VHE-UNV-L835-CD1-U	9125	68.2	134
22CZ2-95VHE-UNV-L835-CD1-U	9610	72.7	132
22CZ2-100VHE-UNV-L835-CD1-U	10108	77.7	130
22CZ2-110VHE-UNV-L835-CD1-U	11065	87.7	126

Shielding

Lumen Adjustment Factors		
S	HRP	SQR
1.05	0.80	0.96

Lumen Calculator

CCT Multiplier	80 CRI	90 CRI ⁽¹⁾	BioUp Static
3000K	0.965	0.827	-
3500K	1.000	0.847	0.912
4000K	1.019	0.856	0.899
5000K	1.019	0.909	0.879

Notes: (1) Input wattages for 90 CRI versions may vary. Refer to published IES-format photometry or LM-79 reports for more details.

Example of Lumen Adjustment Calculation

22CZ2-32-UNV-L935-CD1-U at 90CRI at 3500K

Lumen Adjustment Factor = 0.845

Total Light Output =

3,280 lm x 0.845 = 2,772 lm

Efficacy = 2,772 lm = 103.8 lm/W
26.7W**Lumen Maintenance**

Version	TM-21 Lumen Maintenance (60,000 hours) ⁽²⁾	Theoretical L70 (Hours) ⁽³⁾
Standard	> 85%	> 151,000
High Efficiency	> 90%	> 203,000
Very High Efficiency	> 90%	> 203,000

Notes: (2) Supported by IES TM-21 standards. (3) Theoretical values represent estimations commonly used; however, refer to the IES position on LED Product Lifetime Prediction, IES PS-10-18, that explains proper use of IES TM-21 and LM-80.

Load Data (Stock Product)

Thd	6%
Power Factor	0.99
Weight (lbs.)	10.6
Low Temp. Start	-20°C

Shipping Data

Catalog No.	Wt.	Pallet 49"L x 52"W x 55"H
2' x 2'	12.5 lbs.	48

Air Return Volume

Negative Static Pressure (Inches H ₂ O)	Return Air Volume (CFM)
0.05	79
0.1	112
0.2	161
0.25	177
0.3	198
0.45	239



Job Name:

New Training Facility - St. Tammany Fire Protection District No. 1
 Architect: DAMMON ENGINEERS INC (Slidell)
 Engineer: DAMMON ENGINEERS INC (Slidell)

Catalog Number:

22CZ2-32-UNV-L840-CD1-U

Notes:

Type:

F2

WK25-44042

Metalux

22CZ2 LED

Control Solutions

- WaveLinX LITE wireless
- WaveLinX PRO wireless
- WaveLinX CAT wired
- WaveLinX Wired



The Cruze ST with WaveLinX offers no-hassle lighting control with multiple luminaire level control solutions.



WaveLinX PRO is a wireless lighting control solution, for connected spaces, that significantly reduces a building's energy consumption. From a single floor to an entire campus, WaveLinX PRO connects more than lighting assets; it shares aggregated sensor data with the WaveLinX CORE platform and other building systems, so building owners can improve operations, spaces environment, and tenants' experience. WaveLinX PRO offers a rich portfolio of wireless devices, WaveLinX PRO-enabled luminaires, and an intuitive WaveLinX mobile app for office, education, warehouse, and parking garage applications.



WaveLinX LITE is a cost effective, wireless digital lighting control solution, with out-of-the-box functionality, that saves energy and meets code. It's designed for applications that require occupancy-based, daylighting, or manual light control. Customize installations for office, education, warehouse and parking garages using the secure, simple mobile app.

Integrated Sensor Coverage Pattern

TOP VIEW:

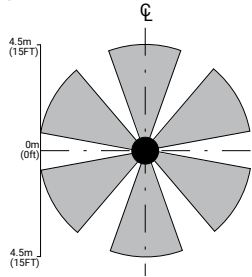

SIDE VIEW:

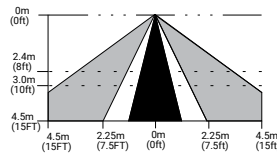

Note: Installation of integrated sensors within 3-ft (1m) of HVAC air vents is not recommended. The pattern shown is intended solely as a general guide and is not to scale.

With Integrated WaveLinX Sensor

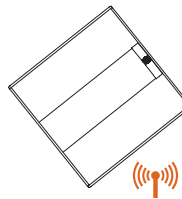

With Integrated WaveLinX Node

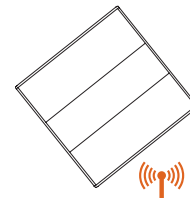

Add a hidden WaveLinX sensor node (WPN, WLN) to your space lighting design!

Allows to:

- Keeps luminaire aesthetics
- Connect fixtures without the realstate to include sensor option such as downlights
- Connect sealed fixtures without a standard sensor option such as products for clinical space.

Integrated Controls Options

Option	Out of the Box Functionality	Luminaire Level Lighting Control (LLC)	Automatic Dimming Photocell	Occupancy Sensing	CCT Control
WLS	X	X	X	X	
WLN		X			
WPS		X	X	X	X
WPN		X			X

Systems comparison chart

Cooper Lighting Solutions provides many lighting system solutions designed to satisfy code requirements and meet the unique needs of any project.

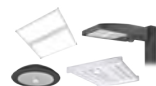

Luminaire with standalone sensor

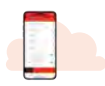

Standalone Spaces WaveLinX LITE



Standalone Spaces WaveLinX CAT



Networked Spaces WaveLinX PRO



Enterprise WaveLinX CORE

	Luminaire with standalone sensor	Standalone Spaces WaveLinX LITE	Standalone Spaces WaveLinX CAT	Networked Spaces WaveLinX PRO	Enterprise WaveLinX CORE
Occupancy	Yes	Yes	Yes	Yes	Yes
Daylighting	Yes	Yes	Yes	Yes	Yes
Wallstations	-	Yes	Yes	Yes	Yes
Gateways	-	-	-	1 WAC	300 WACs
Devices (MAX)	-	40 per Area (1120 per space)	40 per Area	200 per WAC2	32,500 per CORE Enterprise
Software	-	WaveLinX LITE Mobile App	WaveLinX CAT Mobile App	WaveLinX Mobile App	CORE
Areas	-	28 per Space	Unlimited	50 per WAC2	up to 3,000
Zones	-	16 per Area	16 per Area	16 per Area	up to 9,000
Scheduling	-	-	-	Local	Global
VividTune™	-	-	-	Yes	Yes
Plug-Load Control	-	Yes	Yes	Yes	Yes
Low-Voltage Power	-	-	Yes	Yes	Yes
Integration	-	-	-	-	BACnet, API
Dashboards	-	-	-	-	Energy, Occupancy
Configuration	-	Installer	Installer	Technician	Technician / IT

Note: WaveLinX utilizes scenes to allow users to change an area's fixtures Correlated Color Temperature (CCT) and intensity using commissioned manual wireless wallstation scene control. To enable CCT adjustments through WaveLinX, include WPS or WPN devices in addition to VividTune or BioUp technologies for integrated fixture control.



Job Name:

New Training Facility - St. Tammany Fire Protection District No. 1
 Architect: DAMMON ENGINEERS INC (Slidell)
 Engineer: DAMMON ENGINEERS INC (Slidell)

Catalog Number:

22CZ2-32-UNV-L840-CD1-U

Notes:

Type:

F2

WK25-44042

Metalux

22CZ2 LED



22 Cruze ST LED with VividTune Tunable White

VividTune tunable white luminaires from Cooper Lighting Solutions deliver high-quality light in a broad range of continuously variable color temperatures and intensities. Create a dynamic environment by adjusting the ambient light warmer or cooler to influence mood, support the task at hand, or create a dramatic ambience. The ability to control correlated color temperature and intensity separately using simple controls is the next evolution of LED lighting for the commercial, educational, healthcare and hospitality space. The unparalleled flexibility and number of available lighting environments enable users to find the right light with tunable white.

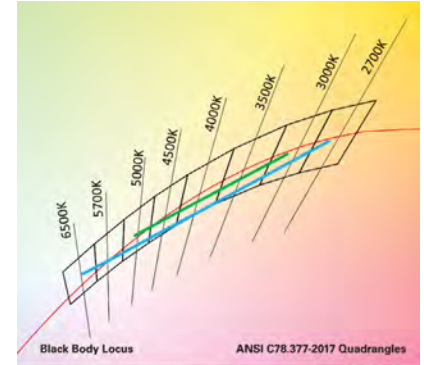

— 3000K - 5000K
 — 2700K - 6500K

Energy and Performance Data

CCT	Tunable White - Lumen Adjustment Factors					
	VividTune 3000K-5000K		VividTune 2700K-6500K		BioUp Tunable White 2700K-5000K	
	80 CRI	90 CRI	80 CRI	90 CRI	CRI	Lumen Adjustment
2700K	-	-	0.903	0.771	95	0.938
3000K	0.929	0.765	0.928	0.801	94	0.929
3500K	0.983	0.836	0.961	0.842	90	0.912
4000K	1.033	0.903	0.981	0.868	87	0.899
4500K	1.042	0.918	0.999	0.891	85	0.890
5000K	1.042	0.918	1.013	0.909	84	0.879
6500K	-	-	1.028	0.933	-	-

CCT Setting	2' x 2' Cruze ST LED - Example of Approximate Lumen Calculation			
	Standard Catalog #	VividTune 80 CRI Catalog #	VividTune 90 CRI Catalog #	BioUp Tunable White
2700K	22CZ2-34HE-UNV-L835-CD1-U	22CZ2-34HE-UNV-L83050-W2A1-U	22CZ2-34HE-UNV-L93050-W2A1-U	22CZ2-34HE-UNV-B2750-W2A1-U
2700K	-	3058	2611	3176
3000K	-	3026	2491	3146
3500K	3386	3202	2722	3088
4000K	-	3362	2940	3044
4500K	-	3394	2991	3014
5000K	-	3394	2991	2976
6500K	-	3481	3159	-

Controlling VividTune and BioUp Tunable White

From wall dimmers to wireless controls, tunable white luminaires are compatible with industry standard 0-10V and DALI controls. One channel to control intensity (brightness) and a second channel to adjust CCT.

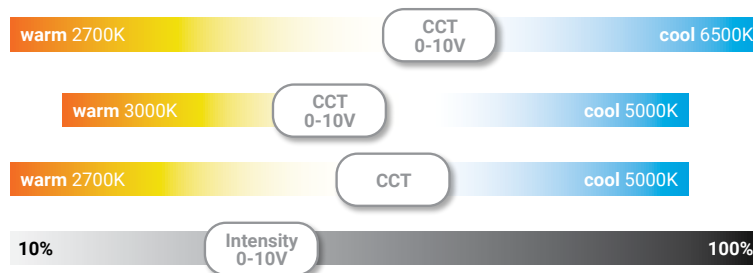

Example of Lumen Adjustment Calculation

22CZ2-34HE-UNV-L83050-W2A1-U at 80 CRI tuned to 3500K

Adjusted Lumen = published lm x adjusted lm factor

Adjusted Lumen = 3386 x 0.946

Adjusted Lumen = 3202 lm

** Lumen adjustment factors are for reference and may be different for each product selected. Refer to IES files for actual performance data on each.*





Job Name:

New Training Facility - St. Tammany Fire Protection District No. 1
 Architect: DAMMON ENGINEERS INC (Slidell)
 Engineer: DAMMON ENGINEERS INC (Slidell)

Catalog Number:

22CZ2-32-UNV-L840-CD1-U

Notes:

Type:

F2

WK25-44042

Metalux

22CZ2 LED

Proven Research. Industry Recognized.

BioUp
 Melanopic Lighting



See better



Feel better



Function better



See [BioUp brochure](#) for more details



ANSI/IES RP-46-23 / TM18 published March 2024 based on over 40 years of research.

"...circadian clock synchronization is paramount to the body's efficient and appropriate functioning." – TM18



BioUp solutions maximize WELL points for Circadian Lighting Design (L03):

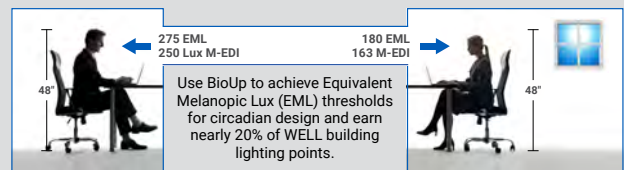

MDER, M-EDI and EML are key metrics used to quantify non-visual performance of indoor lighting systems.

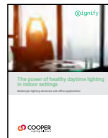

See [BioUp white paper](#) for more details

30% boost Biological impact
 compared to traditional LED sources

CCT	LED MDER ~83 CRI	BioUp Static		BioUp Dynamic	
		MDER	CRI	MDER	CRI
2700K	0.44	-	-	0.43	95
3000K	0.49	-	-	0.54	94
3500K	0.56	0.71	90	0.71	90
4000K	0.64	0.84	87	0.82	87
5000K	0.77	0.98	84	0.98	84

MDER - Melanopic Daylight Efficacy Ratio (MDER) measures the amount of light stimulating to the melanopsin receptors.

Standard 4000K LED
 MDER = .62

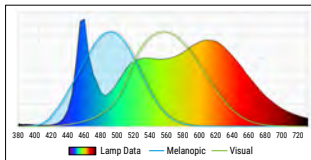

BioUp 4000K LED
 MDER = .82

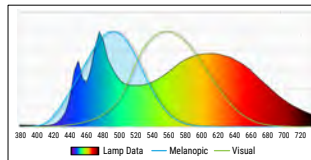

BioUp enhances the LED spectrum with cyan light at 475nm increasing the biological impact of the light to enhance our circadian rhythm which regulates our sleep/wake cycle, daytime engagement, and mood – **all without distorting visual color impression.**

Static (non-tunable)

Static BioUp is used when simple Melanopic Lighting is desired at all times.

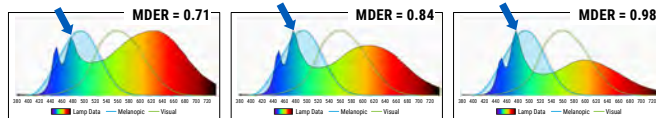

3500K or 4000K or 5000K

Cyan light component always present



> no CCT control needed

Arrow in graph shows BioUp spectrum boost is at 475nm where non-visual biological response is enhanced.

Dynamic - (Tunable)

Dynamic BioUp is used when Melanopic Lighting is desired to adjust during the day.

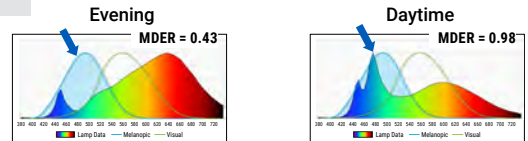

Warmer CCT **Without** Cyan content ← → Cooler Light **With** Cyan content

2700K - 5000K

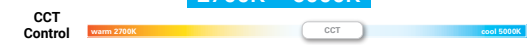

> Control with Wavelinx, 2ch 0-10V, or DALI



Job Name:

New Training Facility - St. Tammany Fire Protection District No. 1
 Architect: DAMMON ENGINEERS INC (Slidell)
 Engineer: DAMMON ENGINEERS INC (Slidell)

Catalog Number:

22CZ2-32-UNV-L840-CD1-U DF-22W-U
 Notes:

Type:

F2A

WK25-44042

Project		Catalog #		Type	
Prepared by		Notes		Date	



Metalux

Cruze ST 22CZ2

2' x 2' LED Specification Grade Troffer

Typical Applications

Office • Education • Healthcare • Hospitality • Retail

Interactive Menu

- Order Information page 2
- Photometric Data page 3
- Control Solutions page 5
- VividTune™ Color Tuning Solutions page 6
- BioUp - Melanopic Lighting page 7
- Product Warranty

Product Certification



Product Features



Top Product Features

- Latch-less design provides clean architectural look
- BioUp melanopic lighting options for 30% circadian boost and earn WELL Building Standard points
- VividTune CCT tuning options from 3000K-5000K or 2700K-6500K
- Designers delight - ribbed, smooth and round perforated lens options
- High performance efficacy up to 151 lm/W
- Integrated sensor systems - occupancy, daylight and IoT connectivity
- Options to meet Buy American and other domestic preference requirements

Dimensional and Mounting Details

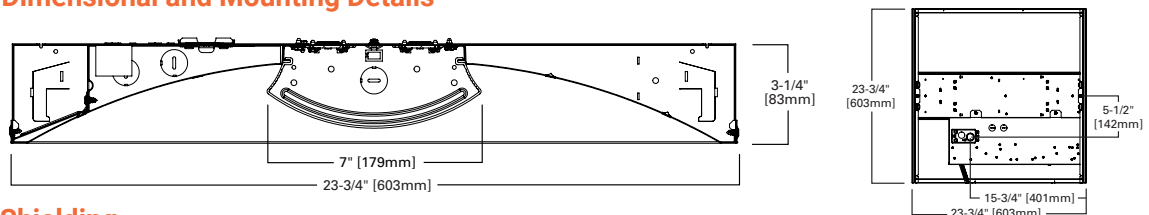

Shielding

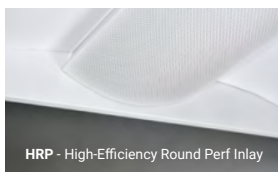

HRP - High-Efficiency Round Perf Inlay



SQR - Square Ribbed Frosted Acrylic Lens

See ordering information for more shielding options.

Ceiling Compatibility

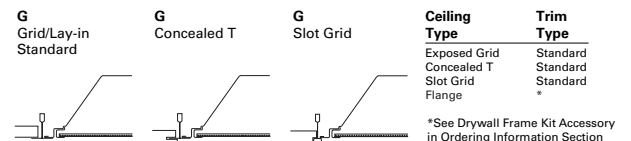



Job Name:
New Training Facility - St. Tammany Fire Protection District No. 1
Architect: DAMMON ENGINEERS INC (Slidell)
Engineer: DAMMON ENGINEERS INC (Slidell)

Catalog Number:

22CZ2-32-UNV-L840-CD1-U DF-22W-U

Notes:

Type:

F2A

WK25-44042

Metalux

22CZ2 LED

Order Information

SAMPLE ORDER NUMBER: **22CZ2-32UNV-L840-CD1-U DF-22W-U**

Domestic Preferences ⁽¹⁾	Rating	Series	Air	Lumen Level / Efficacy Option			Shielding	Voltage ⁽⁵⁾	Options
[Blank]=Standard BAA=Buy American Act TAA=Trade Agreements Act	[Blank]=Standard ATW-SW4=Chicago Rated	22CZ2-2x2 Cruze ST	[Blank]=Standard A=Air (Vented) ⁽²⁾	Standard [Blank] 20=2000 Lumens ⁽⁴⁾ 24=2400 Lumens ⁽⁴⁾ 32=3200 Lumens ⁽⁴⁾ 39=3900 Lumens ⁽⁴⁾ 44=4400 Lumens ⁽⁴⁾	High Efficacy [HE] ^{(4),(5)} 20HE=2000 Lumens 24HE=2400 Lumens 29HE=2900 Lumens 34HE=3400 Lumens 39HE=3900 Lumens 44HE=4400 Lumens	Very High Efficacy [VHE] 20VHE=2000 Lumens 24VHE=2400 Lumens 29VHE=2900 Lumens 34VHE=3400 Lumens 39VHE=3900 Lumens 44VHE=4400 Lumens 50VHE=5000 Lumens 55VHE=5500 Lumens 60VHE=6000 Lumens ⁽⁵⁾ 65VHE=6500 Lumens ⁽⁵⁾ 70VHE=7000 Lumens ^{(3),(6)} 75VHE=7500 Lumens ^{(3),(6)} 80VHE=8000 Lumens ^{(3),(6)} 85VHE=8500 Lumens ^{(3),(6)} 90VHE=9000 Lumens ^{(3),(6)} 95VHE=9500 Lumens ^{(3),(6)} 100VHE=10000 Lumens ^{(3),(6)} 110VHE=11000 Lumens ^{(3),(6)}	[Blank]=Ribbed Frosted Acrylic Lens (standard) S=Smooth Frosted Acrylic Lens HRP=High-Efficiency Round Perf Inlay SQR=Square Ribbed Frosted Acrylic Lens	UNV=Universal Voltage 120-277 347V=347 Volt	GL=Single Element Fuse GM=Double Element Fuse PAF=Painted After Fabrication
Notes (1) Only product configurations with these designated prefixes are built to be compliant with the Buy American Act of 1933 (BAA) or Trade Agreements Act of 1979 (TAA), respectively. Please refer to DOMESTIC PREFERENCES website for more information. Components shipped separately may be separately analyzed under domestic preference requirements.			Notes (2) Air version is intended for air return through plenum. See air return data table for air flow volumes. Air option not available with ATW-SW4. Air requires "PAF" option.	Notes (3) VividTune white tuning and BioUp static and dynamic options are not available with these lumen/efficacy selections. (4) BioUp lumen option. (5) VividTune lumen option. (6) Available with CD and HCD drivers only.				Notes (5) Products also available in non-US voltages and frequencies for international markets.	

L840

Emergency Options	CRI/CCT	Flex
[Blank]=No emergency EL7W=7-watt 120V-277V emergency battery pack ⁽⁶⁾ EL10W=10-watt 120V-277V emergency battery pack ⁽⁶⁾ EL14W=14-watt 120V-277V emergency battery pack ⁽⁶⁾ EL10WSD=10W emergency battery pack with self-diagnostic installed ^{(6),(8)} EL14WSD=14W emergency battery pack with self-diagnostic installed ^{(6),(8)} ETRD=Emergency Transfer Relay with dimming control ⁽⁷⁾ RRU=LVS Controls Emergency Transfer Relay with dimming control ⁽⁷⁾ UEL7W=UL924 Listed luminaire, 7-watt, 120V-277V emergency battery pack ^{(6),(10)} UEL14W=UL924 Listed luminaire, 14-watt 120V-277V emergency battery pack ^{(6),(10)} UEL10WSD=Bodine 10W emergency battery pack with self diagnostic installed ^{(6),(8),(10)} UETRD=UL924 Listed luminaire, Emergency Transfer Relay with dimming control ^{(7),(10)} URRU=UL924 Listed luminaire, LVS Controls Emergency Transfer Relay with dimming control ^{(7),(10)}	L830=80CRI, 3000K L835=80CRI, 3500K L840=80CRI, 4000K L850=80CRI, 5000K L930=90CRI, 3000K L935=90CRI, 3500K L940=90CRI, 4000K L950=90CRI, 5000K L83050=80CRI 3000K-5000K White Tuning ⁽¹²⁾ L93050=90CRI 3000K-5000K White Tuning ⁽¹²⁾ L82765=80CRI 2700K-6500K White Tuning ⁽¹²⁾ L92765=90CRI 2700K-6500K White Tuning ⁽¹²⁾ B35=BioUp Static 3500K ⁽¹³⁾ B40=BioUp Static 4000K ⁽¹³⁾ B50=BioUp Static 5000K ⁽¹³⁾ B2750=BioUp Tunable 2700K-5000K ⁽¹⁴⁾	[Blank]=No Flex A3/8-4/18GDIM=3/8" Flex with 0-10V Dimming Leads A3/8-2/18G=3/8" Flex with line and common A3/8-5/18GDIM=Flex with 0-10V Dimming leads and Blue for alternate wiring. See below for details. Flexible Metal Conduit Options Flex options available for 0-10V dimming control, DALI dimming control, emergency and night light functions. 72-inch factory-installed and pre-wired to driver, fitted to luminaire housing access plate with 90° enclosed FMC connector. Not all options may be combined and installation ratings vary by type. See online configurator for all flex options. A3/8-4/18GDIM series notes: Factory installed dimming option 3/8" flexible metal conduit with 2-#18 power and ground wires and 2-#18 UL-listed jacketed 0-10V +/- control wires. Meets UL 66, 83, 1479, 1569, 1581, 2556, NEC® 250.118, 300.22(C), 392, 396, 399, 501, 502, 503, 530, 504, 505, 518, 520, 530, 645, 72; Federal Specification A-A-59544 (formerly J-C-308); all applicable OSHA and HUD Requirements. UL Classified 1-, 2-, and 3-hour through penetration with applicable fire stop product (not included). May be surface mounted, fished and/or embedded in plaster. Cable tray and approved raceway rated, install per NEC®; Environmental Air-Handling Space Installation per NEC® 300.22(C).
Notes (6) Factory installed with integral test switch/indicator/laser test. For approximate delivered lumens multiply the lumens per watt of the desired fixture by the wattage of the emergency battery pack (100 lm/W x 7=700 lumens). IES-format photometry for luminaire under emergency operation available. Battery option increases total height by 1 inch. (7) Used to bypass local control during outage. Must be used in conjunction with UL 1008 device (provided by others). Devices are universal voltage (UNV). 347 not available. (8) EL10WSD and EL14WSD not available with 347V. (9) UEL10WSD not available with 347V. (10) Cannot be used with BioUp options.	Notes (12) VividTune provides correlated color temperatures (CCT) between 3000K (warm) to 5000K (cool) or 2700K (warm) to 6500K (cool). Must be used in conjunction with W2A driver only. Must be used with two (2) 10V dimming control channels. 1 cct, 1 intensity. May be combined with Wavelinx sensor control systems. (13) BioUp Static to be used with HCD driver. (14) BioUp Tunable provides correlated color temperatures (CCT) between 2700K (warm) to 5000K (cool). Must be used with W2A (for two channel 0-10V Control) or W2D (for 2 channel DALI Control) driver. See BioUp page for more information.	

CD

1

U

DF-22W-U

Driver Type	No. of Drivers	Integrated Sensing Systems ⁽¹⁷⁾	Packaging	Accessories (order separately) ⁽²¹⁾
CD=0-10V Driver (10%-100% Dimming) ⁽²²⁾ HCD=0-10V Driver (1%-100% Dimming) ⁽²²⁾ SLTD=DALI Driver (5%-100% Dimming) SLTHD=DALI Driver (1%-100% Dimming) SD=Step Dimming Driver (50%-100% Dimming) LH=Lutron HiLume 1% EcoSystems (LDE1) ⁽⁷⁾ W2A=White Tuning, 2 cc, Analog 0-10V (1%-100% Dimming) ^{(15),(22)} W2D=White Tuning, DALI Type 8 (1%-100% Dimming) ⁽¹⁶⁾	1=1 Driver	[Blank]=No Sensor WLS (formerly WAB)=WaveLinx LITE Wireless Sensor, Occupancy w/ photocell, Independent & Networked ^{(18),(19)} WPS (formerly WAA)=WaveLinx PRO Wireless Sensor, Occupancy w/ photocell, Networked ^{(18),(19)} WLN=WaveLinx LITE Wireless Control Node, without sensor ^{(18),(19)} WPN=WaveLinx PRO Wireless Control Node, without sensor ^{(18),(19)}	U=Unit Pack PAL=Job Pack, out of carton PALC=Job Pack, in carton	CZ2-EQCLIP-U-PK="CZ2" Earthquake Clip Kit (4 clips per bag kit) ⁽²⁰⁾ DF-22W-U=2 x 2 Drywall Frame Kit SK-22-WS=2 x 2 Shallow Surface Mount Kit SK-22-WT=2 x 2 Tall Surface Mount Kit
Notes (15) W2A used with two (2) 10V dimming control channels - CCT and intensity. (16) W2D for use with BioUp options only. White tuning CCT between 2700K and 5000K. Must be used with DALI controls; one address to control two channels - intensity and CCT. May not be used with sensing systems. For Emergency options ONLY EL10WSD can be used. (22) When selecting 0-10V driver with Integrated Sensing System a 0-10V driver might be substituted with another type. Integrated options must be used in conjunction with the associated system and may not be compatible with other options or accessories. Please refer to the following: (F) Consult Marketplace Options - Lutron system pages for additional details and compatibility. Compatible only with driver series shown, and may require two or more drivers. Requires field commissioning to operate or dim. Contact Lutron at www.lutron.com.		Notes (17) Matching width lens band on other side of sensor band may be supplied for symmetrical appearance. Required for use with sensor and emergency combination. Add "0" to sensor ordering as shown - WPSD, WLS-D. (18) WPS sensor and WPN node to be used with CD, HCD or W2A driver. (19) WLS sensor and WLN node to be used with CD or HCD driver. Integrated options must be used in conjunction with the associated system and may not be compatible with other options or accessories. Please refer to the following: (A) Consult WaveLinx PRO system pages for additional details and compatibility. (B) Consult WaveLinx LITE system pages for additional details and compatibility.		Notes (20) An EQ Grid Clip is recommended for all 9/16" ceiling systems. Four required per fixture. (21) Accessories sold separately will be separately analyzed under domestic preference requirements. Consult factory for further information.



**Job Name:**

New Training Facility - St. Tammany Fire Protection District No. 1
 Architect: DAMMON ENGINEERS INC (Slidell)
 Engineer: DAMMON ENGINEERS INC (Slidell)

Catalog Number:

22CZ2-32-UNV-L840-CD1-U DF-22W-U

Notes:

Type:**F2A**

WK25-44042

Metalux**22CZ2 LED****Product Specifications****Construction**

- Die formed of code gauge prime cold rolled steel with full length die-formed stiffeners
- Unibody endplates attached with interlocking tabs and screws
- Hemmed side flanges
- Four auxiliary fixture end suspension points
- Integral Grid-lock feature for endplates for added safety
- Optional earthquake clips available

Integrated Controls

- Standard with 0-10V dimming driver (10% standard, 1% optional)
- Integrated WaveLinx options provide wireless individual fixture control and enable code compliance, increased energy savings, grouping of fixtures, and connection to WaveLinx control systems
- DALI 2.0, Lutron, and step-dimming available

LED and Light Engine

- LED's available in 3000K, 3500K, 4000K, or 5000K at 80 CRI minimum and 90 CRI minimum
- Color accuracy ≤ 3 -Step MacAdam ellipse (SDCM)
- TM21 life at 60,000 hours up to L90 and calculated L70 exceeds 203,000 hrs.
- Drivers available in 120-277V and 347V
- Tunable white options available with Cooper Lighting Solutions' VividTune
- BioUp melanopic lighting options available in static or tunable white

Emergency Battery Options

- 120V-277V integral emergency battery pack comes in 7-watts, 10-watt, or 14-watts
- Self-diagnostic emergency battery available in 10 or 14-watts (NFPA 101@ Life Safety Code®)
- Constant power to the LED system for controlled, predictable discharge
- Integrated test switch/indicator light visible from floor
- Min. 90-minute backup period for code compliance
- Integral emergency transfer relay available for generator equipped power systems

Shielding

- Ribbed acrylic frosted lens standard
- Optional smooth acrylic frosted lens (S)
- Optional square ribbed frosted acrylic lens (SQR)
- Optional High-Efficiency Round Perf Inlay (HRP)
- Replacement lenses available, contact factory
- Lens is acrylic with features on the face and sides to optimize the direct and indirect lighting contributions for improved glare and efficacy

Compliance

- IC rated for insulation contact
- cULus listed for damp locations
- RoHS compliant
- Tested to IESNA LM-79 and LM-80
- Stated life tested to TM21 standards
- Can be used for State of California Title 24 high efficacy luminaire

Warranty

- Five-year limited warranty standard. Optional ten year limited warranty available.

Finish

- Multistage, iron phosphate pretreatment
- 90% reflective, matte white enamel finish
- Full fixture housing pre-painted matte white (choose PAF option for "Paint after Fabrication")

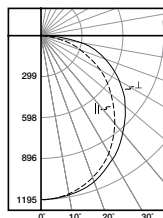
Photometric Data
[View IES files](#)
**22CZ2-24-UNV-L830-CD1-U**

Dimming Driver
 Linear LED 3000K
 Spacing criterion: (H) 1.2 x mounting height, (L) 1.28 x mounting height
 Lumens: 2437
 Input Watts: 21.9W
 Efficacy: 111.3 LPW
 Test Report: 22CZ2-24-UNVL830-CD1-U.IES

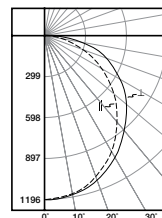
**22CZ2-24HE-UNV-L830-CD1-U**

Dimming Driver
 Linear LED 3000K
 Spacing criterion: (H) 1.19 x mounting height, (L) 1.27 x mounting height
 Lumens: 2402
 Input Watts: 19.2W
 Efficacy: 125.1 LPW
 Test Report: 14CZ2-29-UNV-L830-CD1-U.IES

**Job Name:**

New Training Facility - St. Tammany Fire Protection District No. 1
 Architect: DAMMON ENGINEERS INC (Slidell)
 Engineer: DAMMON ENGINEERS INC (Slidell)

Catalog Number:

22CZ2-32-UNV-L840-CD1-U DF-22W-U

Notes:

Type:**F2A**

WK25-44042

Metalux**22CZ2 LED****Energy and Performance Data**

Standard Efficacy Versions – Single Row of LEDs
 Default CCT/Lumen Setting: 3500K/Med

Catalog Number	Lumens	Watts	lm/W
22CZ2-20-UNV-L835-CD1-U	2142	16.2	132
22CZ2-24-UNV-L835-CD1-U	2454	18.5	133
22CZ2-32-UNV-L835-CD1-U	3272	24.2	135
22CZ2-39-UNV-L835-CD1-U	3953	31	128
22CZ2-44-UNV-L835-CD1-U	4462	33	134

High Efficacy Versions – Two Rows of LEDs

Catalog Number	Lumens	Watts	lm/W
22CZ2-20HE-UNV-L835-CD1-U	2030	15.0	135
22CZ2-24HE-UNV-L835-CD1-U	2474	18.1	137
22CZ2-29HE-UNV-L835-CD1-U	2982	20.9	143
22CZ2-34HE-UNV-L835-CD1-U	3426	24.3	141
22CZ2-39HE-UNV-L835-CD1-U	3997	28.5	140
22CZ2-44HE-UNV-L835-CD1-U	4567	32.8	139

Very High Efficacy Versions – Three Rows of LEDs

Catalog Number	Lumens	Watts	lm/W
22CZ2-20VHE-UNV-L835-CD1-U	2008	14.2	141
22CZ2-24VHE-UNV-L835-CD1-U	2501	17.5	143
22CZ2-29VHE-UNV-L835-CD1-U	3114	21.7	144
22CZ2-34VHE-UNV-L835-CD1-U	3598	25.1	143
22CZ2-39VHE-UNV-L835-CD1-U	4078	28.6	143
22CZ2-44VHE-UNV-L835-CD1-U	4620	32.6	142
22CZ2-50VHE-UNV-L835-CD1-U	5095	36.2	141
22CZ2-55VHE-UNV-L835-CD1-U	5530	39.4	140
22CZ2-60VHE-UNV-L835-CD1-U	6110	44.1	139
22CZ2-65VHE-UNV-L835-CD1-U	6559	47.9	137
22CZ2-70VHE-UNV-L835-CD1-U	7017	50.3	140
22CZ2-75VHE-UNV-L835-CD1-U	7557	54.7	138
22CZ2-80VHE-UNV-L835-CD1-U	8092	59.1	137
22CZ2-85VHE-UNV-L835-CD1-U	8615	63.6	136
22CZ2-90VHE-UNV-L835-CD1-U	9125	68.2	134
22CZ2-95VHE-UNV-L835-CD1-U	9610	72.7	132
22CZ2-100VHE-UNV-L835-CD1-U	10108	77.7	130
22CZ2-110VHE-UNV-L835-CD1-U	11065	87.7	126

Shielding

Lumen Adjustment Factors		
S	HRP	SQR
1.05	0.80	0.96

Lumen Calculator

CCT Multiplier	80 CRI	90 CRI ⁽¹⁾	BioUp Static
3000K	0.965	0.827	-
3500K	1.000	0.847	0.912
4000K	1.019	0.856	0.899
5000K	1.019	0.909	0.879

Notes: (1) Input wattages for 90 CRI versions may vary. Refer to published IES-format photometry or LM-79 reports for more details.

Example of Lumen Adjustment Calculation

22CZ2-32-UNV-L935-CD1-U at 90CRI at 3500K

Lumen Adjustment Factor = 0.845

Total Light Output =

3,280 lm x 0.845 = 2,772 lm

Efficacy = 2,772 lm = 103.8 lm/W
26.7W**Lumen Maintenance**

Version	TM-21 Lumen Maintenance (60,000 hours) ⁽²⁾	Theoretical L70 (Hours) ⁽³⁾
Standard	> 85%	> 151,000
High Efficiency	> 90%	> 203,000
Very High Efficiency	> 90%	> 203,000

Notes: (2) Supported by IES TM-21 standards. (3) Theoretical values represent estimations commonly used; however, refer to the IES position on LED Product Lifetime Prediction, IES PS-10-18, that explains proper use of IES TM-21 and LM-80.

Load Data (Stock Product)

Thd	6%
Power Factor	0.99
Weight (lbs.)	10.6
Low Temp. Start	-20°C

Shipping Data

Catalog No.	Wt.	Pallet 49" L x 52" W x 55" H
2' x 2'	12.5 lbs.	48

Air Return Volume

Negative Static Pressure (Inches H ₂ O)	Return Air Volume (CFM)
0.05	79
0.1	112
0.2	161
0.25	177
0.3	198
0.45	239



Job Name:

New Training Facility - St. Tammany Fire Protection District No. 1
 Architect: DAMMON ENGINEERS INC (Slidell)
 Engineer: DAMMON ENGINEERS INC (Slidell)

Catalog Number:

22CZ2-32-UNV-L840-CD1-U DF-22W-U

Notes:

Type:

F2A

WK25-44042

Metalux

22CZ2 LED

Control Solutions

- WaveLinX LITE wireless
- WaveLinX PRO wireless
- WaveLinX CAT wired
- WaveLinX Wired



The Cruze ST with WaveLinX offers no-hassle lighting control with multiple luminaire level control solutions.



WaveLinX PRO is a wireless lighting control solution, for connected spaces, that significantly reduces a building's energy consumption. From a single floor to an entire campus, WaveLinX PRO connects more than lighting assets; it shares aggregated sensor data with the WaveLinX CORE platform and other building systems, so building owners can improve operations, spaces environment, and tenants' experience. WaveLinX PRO offers a rich portfolio of wireless devices, WaveLinX PRO-enabled luminaires, and an intuitive WaveLinX mobile app for office, education, warehouse, and parking garage applications.



WaveLinX LITE is a cost effective, wireless digital lighting control solution, with out-of-the-box functionality, that saves energy and meets code. It's designed for applications that require occupancy-based, daylighting, or manual light control. Customize installations for office, education, warehouse and parking garages using the secure, simple mobile app.

Integrated Sensor Coverage Pattern

TOP VIEW:

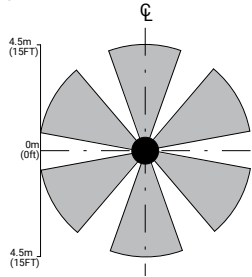

SIDE VIEW:

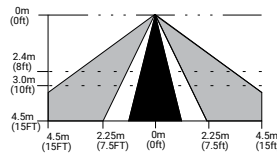

Note: Installation of integrated sensors within 3-ft (1m) of HVAC air vents is not recommended. The pattern shown is intended solely as a general guide and is not to scale.

With Integrated WaveLinX Sensor

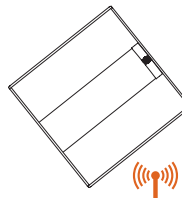

With Integrated WaveLinX Node

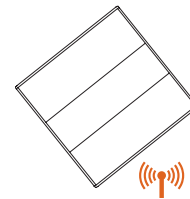

Add a hidden WaveLinX sensor node (WPN, WLN) to your space lighting design!

Allows to:

- Keeps luminaire aesthetics
- Connect fixtures without the realstate to include sensor option such as downlights
- Connect sealed fixtures without a standard sensor option such as products for clinical space.

Integrated Controls Options

Option	Out of the Box Functionality	Luminaire Level Lighting Control (LLC)	Automatic Dimming Photocell	Occupancy Sensing	CCT Control
WLS	X	X	X	X	
WLN		X			
WPS		X	X	X	X
WPN		X			X

Systems comparison chart

Cooper Lighting Solutions provides many lighting system solutions designed to satisfy code requirements and meet the unique needs of any project.



Luminaire with standalone sensor

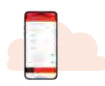

Standalone Spaces WaveLinX LITE



Standalone Spaces WaveLinX CAT



Networked Spaces WaveLinX PRO



Enterprise WaveLinX CORE

	Luminaire with standalone sensor	Standalone Spaces WaveLinX LITE	Standalone Spaces WaveLinX CAT	Networked Spaces WaveLinX PRO	Enterprise WaveLinX CORE
Occupancy	Yes	Yes	Yes	Yes	Yes
Daylighting	Yes	Yes	Yes	Yes	Yes
Wallstations	-	Yes	Yes	Yes	Yes
Gateways	-	-	-	1 WAC	300 WACs
Devices (MAX)	-	40 per Area (1120 per space)	40 per Area	200 per WAC2	32,500 per CORE Enterprise
Software	-	WaveLinX LITE Mobile App	WaveLinX CAT Mobile App	WaveLinX Mobile App	CORE
Areas	-	28 per Space	Unlimited	50 per WAC2	up to 3,000
Zones	-	16 per Area	16 per Area	16 per Area	up to 9,000
Scheduling	-	-	-	Local	Global
VividTune™	-	-	-	Yes	Yes
Plug-Load Control	-	Yes	Yes	Yes	Yes
Low-Voltage Power	-	-	Yes	Yes	Yes
Integration	-	-	-	-	BACnet, API
Dashboards	-	-	-	-	Energy, Occupancy
Configuration	-	Installer	Installer	Technician	Technician / IT

Note: WaveLinX utilizes scenes to allow users to change an area's fixtures Correlated Color Temperature (CCT) and intensity using commissioned manual wireless wallstation scene control. To enable CCT adjustments through WaveLinX, include WPS or WPN devices in addition to VividTune or BioUp technologies for integrated fixture control.



Job Name:

New Training Facility - St. Tammany Fire Protection District No. 1
 Architect: DAMMON ENGINEERS INC (Slidell)
 Engineer: DAMMON ENGINEERS INC (Slidell)

Catalog Number:

22CZ2-32-UNV-L840-CD1-U DF-22W-U

Notes:

Type:

F2A

WK25-44042

Metalux

22CZ2 LED



22 Cruze ST LED with VividTune Tunable White

VividTune tunable white luminaires from Cooper Lighting Solutions deliver high-quality light in a broad range of continuously variable color temperatures and intensities. Create a dynamic environment by adjusting the ambient light warmer or cooler to influence mood, support the task at hand, or create a dramatic ambience. The ability to control correlated color temperature and intensity separately using simple controls is the next evolution of LED lighting for the commercial, educational, healthcare and hospitality space. The unparalleled flexibility and number of available lighting environments enable users to find the right light with tunable white.

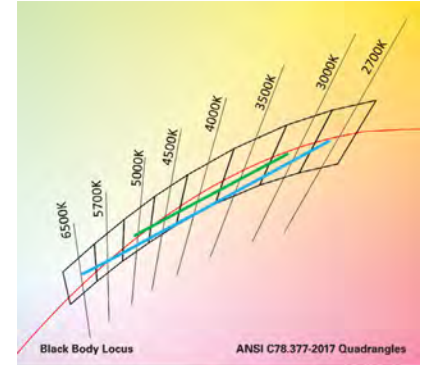

— 3000K - 5000K
 — 2700K - 6500K

Energy and Performance Data

CCT	Tunable White - Lumen Adjustment Factors					
	VividTune 3000K-5000K		VividTune 2700K-6500K		BioUp Tunable White 2700K-5000K	
	80 CRI	90 CRI	80 CRI	90 CRI	CRI	Lumen Adjustment
2700K	-	-	0.903	0.771	95	0.938
3000K	0.929	0.765	0.928	0.801	94	0.929
3500K	0.983	0.836	0.961	0.842	90	0.912
4000K	1.033	0.903	0.981	0.868	87	0.899
4500K	1.042	0.918	0.999	0.891	85	0.890
5000K	1.042	0.918	1.013	0.909	84	0.879
6500K	-	-	1.028	0.933	-	-

CCT Setting	2' x 2' Cruze ST LED - Example of Approximate Lumen Calculation			
	Standard Catalog #	VividTune 80 CRI Catalog #	VividTune 90 CRI Catalog #	BioUp Tunable White
2700K	22CZ2-34HE-UNV-L835-CD1-U	22CZ2-34HE-UNV-L83050-W2A1-U	22CZ2-34HE-UNV-L93050-W2A1-U	22CZ2-34HE-UNV-B2750-W2A1-U
2700K	-	3058	2611	3176
3000K	-	3026	2491	3146
3500K	3386	3202	2722	3088
4000K	-	3362	2940	3044
4500K	-	3394	2991	3014
5000K	-	3394	2991	2976
6500K	-	3481	3159	-

Controlling VividTune and BioUp Tunable White

From wall dimmers to wireless controls, tunable white luminaires are compatible with industry standard 0-10V and DALI controls. One channel to control intensity (brightness) and a second channel to adjust CCT.

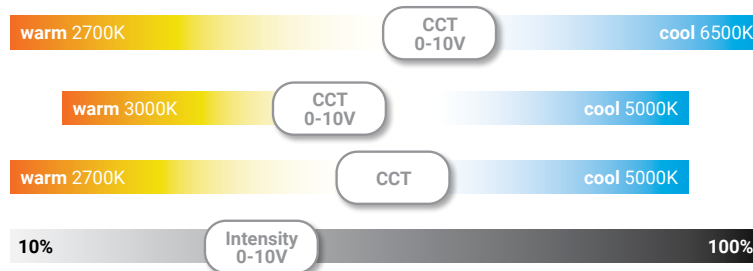

Example of Lumen Adjustment Calculation

22CZ2-34HE-UNV-L83050-W2A1-U at 80 CRI tuned to 3500K

Adjusted Lumen = published lm x adjusted lm factor

Adjusted Lumen = 3386 x 0.946

Adjusted Lumen = 3202 lm

** Lumen adjustment factors are for reference and may be different for each product selected. Refer to IES files for actual performance data on each.*





Job Name:

New Training Facility - St. Tammany Fire Protection District No. 1
 Architect: DAMMON ENGINEERS INC (Slidell)
 Engineer: DAMMON ENGINEERS INC (Slidell)

Catalog Number:

22CZ2-32-UNV-L840-CD1-U DF-22W-U

Notes:

Type:

F2A

WK25-44042

Metalux

22CZ2 LED

Proven Research. Industry Recognized.

BioUp
 Melanopic Lighting



See better



Feel better



Function better



See [BioUp brochure](#) for more details



ANSI/IES RP-46-23 / TM18 published March 2024 based on over 40 years of research.

"...circadian clock synchronization is paramount to the body's efficient and appropriate functioning." – TM18



BioUp solutions maximize WELL points for Circadian Lighting Design (L03):

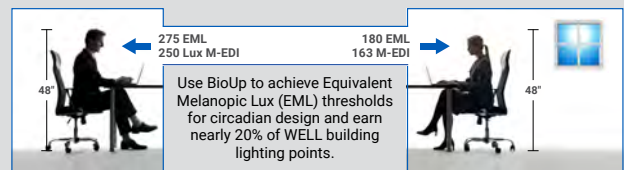

MDER, M-EDI and EML are key metrics used to quantify non-visual performance of indoor lighting systems.

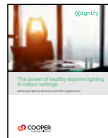

See [BioUp white paper](#) for more details

30% boost Biological impact
 compared to traditional LED sources

CCT	LED MDER ~83 CRI	BioUp Static		BioUp Dynamic	
		MDER	CRI	MDER	CRI
2700K	0.44	-	-	0.43	95
3000K	0.49	-	-	0.54	94
3500K	0.56	0.71	90	0.71	90
4000K	0.64	0.84	87	0.82	87
5000K	0.77	0.98	84	0.98	84

MDER - Melanopic Daylight Efficacy Ratio (MDER) measures the amount of light stimulating to the melanopsin receptors.

Standard 4000K LED
 MDER = .62

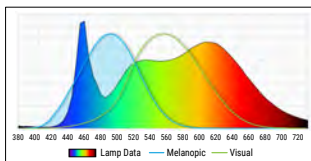

BioUp 4000K LED
 MDER = .82

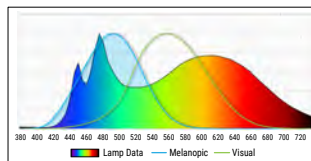

BioUp enhances the LED spectrum with cyan light at 475nm increasing the biological impact of the light to enhance our circadian rhythm which regulates our sleep/wake cycle, daytime engagement, and mood – **all without distorting visual color impression.**

Static (non-tunable)

Static BioUp is used when simple Melanopic Lighting is desired at all times.

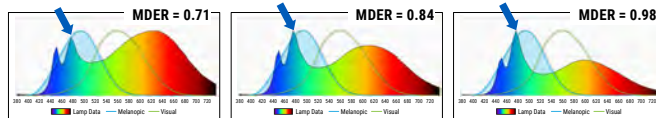

3500K or 4000K or 5000K

Cyan light component always present



> no CCT control needed

Arrow in graph shows BioUp spectrum boost is at 475nm where non-visual biological response is enhanced.

Dynamic - (Tunable)

Dynamic BioUp is used when Melanopic Lighting is desired to adjust during the day.

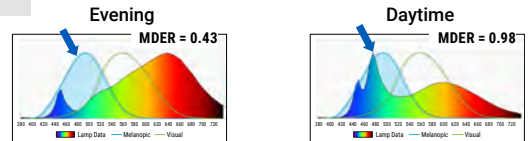

Warmer CCT Without Cyan content ← → Cooler Light With Cyan content

2700K - 5000K



> Control with Wavelinx, 2ch 0-10V, or DALI



Job Name:

New Training Facility - St. Tammany Fire Protection District No. 1
 Architect: DAMMON ENGINEERS INC (Slidell)
 Engineer: DAMMON ENGINEERS INC (Slidell)

Catalog Number:

HC615D010 HM60525930
 61MDCWF

Notes:

Type:

F3

WK25-44042

Project		Catalog #		Type	
Prepared by		Notes		Date	



HALO Commercial

HC6 | HM6 | 61 | 61PS

6-inch LED downlight and wall wash

Typical Applications

Office • Healthcare • Hospitality • Institutional • Mixed-Use/Retail

Interactive Menu

- Order Information page 2
- Product Specifications page 4
- Photometric Data page 5
- Energy & Performance Data page 8
- Connected Systems page 10
- Product Warranty

Top Product Features

- New construction/remodel series; 500 to 6,000 lumens
- Narrow, Medium and Wide distributions; Wall wash with rotatable linear spread lens
- 2700K, 3000K, 3500K, 4000K, 5000K CCT; 80 or 90 CRI
- Universal voltage 120V-277V; Standard 0-10V driver dims to 1%
- Mounting frame converts to remodel that installs from below the ceiling
- Quick Spec emergency backup mounting frames - fast delivery option

Product Certification



Product Features



Control Compatibility



Dimensional and Mounting Details

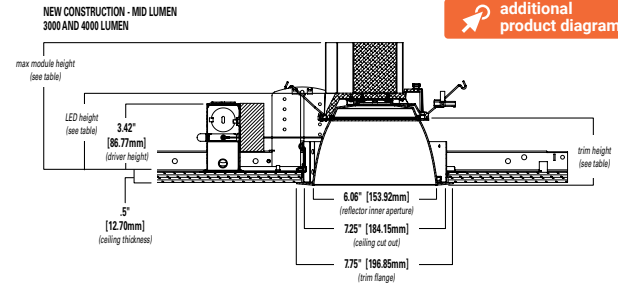
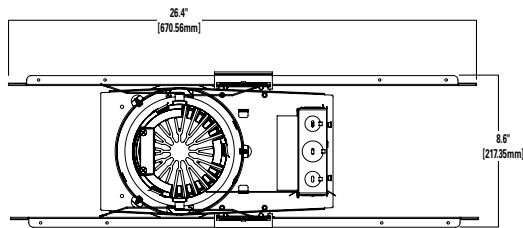

Mid Lumen (3000 - 4000 Lumens)

Distribution	Max. Module Height	Trim Height	LED Height
Narrow	6.6"	3.4"	3.8"
Medium	6.7"	3.5"	3.9"
Wide	6.5"	3.3"	3.7"
Baffle	6.5"	3.3"	3.7"



Job Name:
New Training Facility - St. Tammany Fire Protection District No. 1
Architect: DAMMON ENGINEERS INC (Slidell)
Engineer: DAMMON ENGINEERS INC (Slidell)

Catalog Number:
HC615D010 HM60525930
61MDCWF
Notes:

Type:
F3
WK25-44042

HALO Commercial

HC6 | HM6 | 61 | 61PS

Mounting Frame Order Information

Sample Number: **HC615D010 HM60525930 61MDCWF**

A complete luminaire consists of a housing frame, LED module, and reflector (ordered separately)

HC6	15	D010		
Mounting Frame	Lumens	Driver Options	Factory Installed Emergency & Connected Lighting Options	Accessories (Order & Install Separately)
<p>HC6 = 6" new construction downlight housing</p> <p>HC6CP = 6" new construction housing, Chicago Plenum - CCEA compliant</p>	<p>05 = 500 lm 07 = 750 lm 10 = 1000 lm 15 = 1500 lm 20 = 2000 lm 25 = 2500 lm 30 = 3000 lm 35 = 3500 lm 40 = 4000 lm 45 = 4500 lm ⁽⁷⁾ 50 = 5000 lm ⁽⁷⁾ 55 = 5500 lm ⁽⁷⁾ 60 = 6000 lm ⁽⁷⁾</p>	<p>D010=UNV 120-277V, 50/60Hz, 0-10V 1%-100% dimming at 120-277V on 0-10V controls</p> <p>Canada Option 500-4000 lumens: D010X347 = 347VAC 50/60Hz 0-10V 1%-100% dimming. For 500, 750, 1000, 1500, 2000, 2500, 3000, 3500, 4000lm models only ⁽¹⁾</p> <p>Canada Option 4500-6000 lumens: D010X347 = step down transformer factory installed (with standard "D010" 120V-277V LED driver). For 4500, 5000, 5500, 6000lm models only ⁽¹⁾</p> <p>DLV = Distributed Low Voltage dimming driver 1%-100%, 1000-4000 lumens only. For use with DLVP system only, refer to DLVP specifications for details. ⁽¹⁾</p>	<p>REM7 = 7 watt emergency battery pack with remote test / indicator light, use with D010 only ⁽¹⁾⁽²⁾⁽⁶⁾</p> <p>REM14 = 14 watt emergency battery pack with remote test / indicator light, use with D010 only ⁽¹⁾⁽²⁾⁽⁶⁾</p> <p>IEM7 = 7 watt emergency battery pack with integral test / indicator light, use with D010 only ⁽¹⁾⁽²⁾⁽⁶⁾</p> <p>IEM14 = 14 watt emergency battery pack with integral test / indicator light, use with D010 only ⁽¹⁾⁽²⁾⁽⁶⁾</p> <p>BOD7ST = 7.5 watt Bodine self-test emergency battery pack with remote test / indicator light, use with D010 only ⁽¹⁾⁽²⁾⁽⁶⁾</p> <p>WTA = Factory WaveLinX PRO Tilemount Sensor Kit ⁽⁴⁾</p> <p>WTK = Factory WaveLinX LITE Tilemount Sensor Kit ⁽⁵⁾</p> <p>WPN = WaveLinX PRO Wireless Node without Sensor ⁽⁹⁾</p> <p>WLN = WaveLinX LITE Wireless Node without Sensor ⁽¹⁰⁾</p> <p>REM7V = 7 watt emergency battery pack with remote test / indicator light, use with DLV only ⁽¹⁾⁽²⁾⁽³⁾⁽⁶⁾</p> <p>REM14V = 14 watt emergency battery pack with remote test / indicator light, use with DLV only ⁽¹⁾⁽²⁾⁽³⁾⁽⁶⁾</p> <p>IEM7V = 7 watt emergency battery pack with integral test / indicator light, use with DLV only ⁽¹⁾⁽²⁾⁽³⁾⁽⁶⁾</p> <p>IEM14V = 14 watt emergency battery pack with integral test / indicator light, use with DLV only ⁽¹⁾⁽²⁾⁽³⁾⁽⁶⁾</p>	<p>HB128APK = L channel hanger bar, 26", pair (replacement)</p> <p>RMB22 = Adjustable wood joist mounting bars, pair, extend to 22" long</p> <p>HSA6 = Slope Adapter for 6" Aperture Housings, Specify Slope (refer to instructions for installing housing and trim)</p> <p>H347 = 347 to 120V step down transformer, 75VA</p> <p>H347200 = 347 to 120V step down transformer, 200VA</p> <p>WTA = Field WaveLinX PRO Tilemount Sensor Kit ⁽⁴⁾</p> <p>WTK = Field WaveLinX LITE Tilemount Sensor Kit ⁽⁵⁾</p>
Notes	Notes	Notes	Notes	Notes
	(7) Marked Spacing: Center to Center of Adjacent Luminaires = 36" Center of Luminaire to Building Member = 18" Minimum overhead = 0.5	(1) Not available with CP models	(1) Not available with CP models (2) Not available with D010347 (347V models) (3) ULus for U.S. only (4) WTA = WaveLinX PRO tilemount sensor kit for daylight dimming, PIR motion sensing, and optional RLTS - Real Time Location Services, use with D010 only. (Refer to WaveLinX PRO specifications.) (5) WTK = WaveLinX LITE tilemount sensor kit for daylight dimming, PIR motion sensing, use with D010 only. (Refer to WaveLinX LITE specifications.) (6) Emergency battery backup options are Non-IC only, and rated for a minimum starting temperature of 0°C (9) WPN = WaveLinX PRO wireless node provides luminaire-level control with scene and zone configuration without an integrated sensor; Connects wirelessly with daylight dimming sensor and PIR motion sensor if desired. Use with 0-10V driver only. Not compatible with 347V or Chicago plenum. (Refer to WaveLinX PRO specifications.) (10) WLN = WaveLinX LITE wireless node provides luminaire-level control with scene and zone configuration without an integrated sensor; Connects wirelessly with daylight dimming sensor and PIR motion sensor if desired. Use with 0-10V driver only. Not compatible with 347V or Chicago plenum. (Refer to WaveLinX LITE specifications.)	(4) WTA = WaveLinX PRO tilemount sensor kit for daylight dimming, PIR motion sensing, and optional RLTS - Real Time Location Services, use with D010 only. (Refer to WaveLinX PRO specifications.) (5) WTK = WaveLinX LITE tilemount sensor kit for daylight dimming, PIR motion sensing, use with D010 only. (Refer to WaveLinX LITE specifications.)

Quick Spec Emergency Mounting Frame Order Information

Sample Number:

Quick Spec Emergency Mounting Frame: **RR-HC620D010REM7**

LED module and reflectors are ordered separately.

Order separately: LED Module: HM60525835 | Reflector: 61MDC

Select from the Quick Spec Mounting Frame ordering information to receive the **Fast Delivery** option for the frame.

Quick Spec Code	Mounting Frame	Lumens	Driver Options	Factory Installed Emergency & Connected Lighting Options	Accessories (Order & Install Separately)
<p>RR = East Region BRR = West Region</p>	<p>HC6 = 6" new construction downlight housing</p>	<p>10 = 1000 lm 15 = 1500 lm 20 = 2000 lm 30 = 3000 lm 40 = 4000 lm</p>	<p>D010=UNV 120-277V, 50/60Hz, 0-10V 1%-100% dimming at 120-277V on 0-10V controls</p>	<p>REM7 = 7 watt emergency battery pack with remote test / indicator light, use with D010 only ⁽²⁾⁽⁶⁾</p> <p>REM14 = 14 watt emergency battery pack with remote test / indicator light, use with D010 only ⁽²⁾⁽⁶⁾</p> <p>IEM7 = 7 watt emergency battery pack with integral test / indicator light, use with D010 only ⁽²⁾⁽⁶⁾</p> <p>IEM14 = 14 watt emergency battery pack with integral test / indicator light, use with D010 only ⁽²⁾⁽⁶⁾</p>	<p>HB128APK = L channel hanger bar, 26", pair (replacement)</p> <p>RMB22 = Adjustable wood joist mounting bars, pair, extend to 22" long</p>
Notes	Notes	Notes	Notes	Notes	Notes
				(2) Not available with D010347 (347V models) (6) Emergency battery backup options are Non-IC only, and rated for a minimum starting temperature of 0°C	



Job Name:
 New Training Facility - St. Tammany Fire Protection District No. 1
 Architect: DAMMON ENGINEERS INC (Slidell)
 Engineer: DAMMON ENGINEERS INC (Slidell)

Catalog Number:
 HC615D010 HM60525930
 61MDCWF
 Notes:

Type:
F3
 WK25-44042

HALO Commercial HC6 | HM6 | 61 | 61PS

LED Module Order Information

HM6	0525	930	
LED Module	Lumens	CRI/CCT	
HM6 = 6" LED Modules For use with HC6 - HC6CP New Construction housings only	0525 = 500 - 2500 lumen 3040 = 3000-4000 lumen 4560 = 4500-6000 lumen	827 = 80CRI, 2700K 830 = 80CRI, 3000K 835 = 80CRI, 3500K 840 = 80CRI, 4000K 850 = 80CRI, 5000K	927 = 90CRI, 2700K 930 = 90CRI, 3000K 935 = 90CRI, 3500K 940 = 90CRI, 4000K 950 = 90CRI, 5000K
Notes	Notes	Notes	

Trim Order Information

61	MD	C	WF	
Reflector	Distribution ⁽⁸⁾	Finish	Flange	Accessories
61 = 6" conical reflector	ND = narrow 55° beam angle 0.97 SC MD = medium 60° beam angle 1.10 SC WD = wide 65° beam angle 1.28 SC RW = rotatable wall wash with linear spread lens	C = Specular clear H = Semi-specular clear W = White	Blank = Polished flange standard with C & H reflectors Blank = White flange standard with W reflector WF = White flange option available with C & H reflectors BF = Black Flange option available with C, H & W reflectors	61RWWPK = Replacement part kit - wall wash lens insert - for use with 61RWW* only.
Notes	Notes <small>(8) Values are nominal, with specular clear reflector, other finishes and field results may vary.</small>	Notes	Notes	Notes

Baffle	Distribution ⁽⁸⁾	Finish	Flange	Accessories
61 = 6" baffle reflector	WD = wide 65° beam angle 1.28 SC (nominal) RW = rotatable wall wash with linear spread lens	BB = Black baffle WB = White baffle	Blank = White flange standard with BB, & WB reflectors BF = Black flange option available with BB reflectors	61RWWPK = Replacement part kit - wall wash lens insert - for use with 61RWW* only.
Notes	Notes <small>(8) Values are nominal, with specular clear reflector, other finishes and field results may vary.</small>	Notes	Notes	Notes

Reflector	Distribution ⁽⁸⁾	Finish	Flange
61PS = 6" non-conductive polymer 'dead front' conical reflector⁽⁹⁾	MD = medium 60° beam angle 1.10 SC (nominal)	W = White	Blank = White flange standard with W reflector BF = Black Flange option available with W reflectors
Notes <small>(9) 61PS is 1000-2000 lumens Non-IC rated. 500 & 750 lumens IC rated. 61PS is not for use over 2000lm in Non-IC or over 750lm in IC.</small>	Notes <small>(8) Values are nominal, with specular clear reflector, other finishes and field results may vary.</small>	Notes	Notes

IEM Reflector	Distribution ⁽⁸⁾	Finish	Flange	Integral Emergency
61 = 6" IEM reflector for integral emergency only	ND = narrow 55° beam angle 0.97 SC MD = medium 60° beam angle 1.10 SC WD = wide 65° beam angle 1.28 SC	C = Specular clear H = Semi-specular clear W = White	Blank = Polished flange standard with C & H reflectors Blank = White flange standard with W reflector WF = White flange option available with C & H reflectors BF = Black flange option available with C, H, & W reflectors	IEM = Reflector for use with integral emergency housings only. Provides access hole for integral emergency test switch.
Notes	Notes <small>(8) Values are nominal, with specular clear reflector, other finishes and field results may vary.</small>	Notes	Notes	Notes

IEM Baffle	Distribution ⁽⁸⁾	Finish	Flange	Integral Emergency
61 = 6" IEM baffle reflector for integral emergency only	WD = wide 65° beam angle 1.28 SC (nominal)	BB = Black baffle WB = White baffle	Blank = White flange standard with BB, & WB reflectors BF = Black flange option with BB reflectors	IEM = Reflector for use with integral emergency housings only. Provides access hole for integral emergency test switch.
Notes	Notes <small>(8) Values are nominal, with specular clear reflector, other finishes and field results may vary.</small>	Notes	Notes	Notes

**Job Name:**

New Training Facility - St. Tammany Fire Protection District No. 1
 Architect: DAMMON ENGINEERS INC (Slidell)
 Engineer: DAMMON ENGINEERS INC (Slidell)

Catalog Number:

HC615D010 HM60525930
 61MDCWF

Notes:

Type:**F3**

WK25-44042

HALO Commercial**HC6 | HM6 | 61 | 61PS****Product Specifications****Housing Frame**

- Boat shaped galvanized steel plaster frame with adjustable plaster lip
- Accommodates 1/2" to 1-1/2" thick ceilings
- Installs in new construction or from below the finished ceiling (non-accessible) for remodeling (with mounting bars removed)
- Provided with two remodel clips to secure the frame to the ceiling

Universal Mounting Bracket

- Adjusts 2" vertically from above and below the ceiling
- Use with the included mounting bars or with 1/2" Electric Metallic Tube (EMT)
- Removable to facilitate remodeling installation from below the finished ceiling

Mounting Bars

- Captive pre-installed No Fuss™ mounting bars lock to T-grid with screwdriver or pliers
- Centering detents allow for consistent positioning of fixtures

LED Module

- Proximity phosphors over chip on board LEDs provide a uniform source with high efficiency and no pixilation
- Available in 80 or 90 color rendering index (CRI)
- Color accuracy within 3 SDCM provides color consistency and uniformity
- 90 CRI option: R9>50 (refer to chromaticity information for details)
- Available in 2700K, 3000K, 3500K, 4000K and 5000K correlated color temperature (CCT)
- Lumen options include 500, 750, 1000, 1500, 2000, 2500, 3000, 3500, 4000, 4500, 5000, 5500, 6000 lumens (nominal)
- Passive thermal management achieves 60,000 hours at 70% lumen maintenance (L70) in insulated ceilings (IC) and non-IC applications
- Integral diffuse lens provides visual shielding
- Integral connector allows quick connection to housing flex

Reflector

- Self-flanged aluminum reflectors available in narrow, medium or wide distribution patterns
- Medium distribution polymer non-conductive matte white reflector may be used to meet local codes for 'dead front' applications (500 & 750 lumen max. in IC and 2000 lumen max. in Non-IC)
- Wall wash reflector features a rotatable linear spread lens for alignment of vertical illumination
- Reflectors attach to LED module with three speed clamps
- Available in multiple painted or plated finishes

Reflector/Module Retention

- Reflector/module assembly is securely retained in the housing with two torsion springs

Driver

- Field-replaceable constant current driver provides low noise operation
- Universal 120-277VAC 50/60Hz input standard
- Continuous, 1% to 100% dimming with 0-10V analog control
- Optional low-voltage DC driver for use with Distributed Low Voltage Power (DLVP) system
- Distributed Low Voltage Power (DLVP) system combines power, lighting and controls with ease of installation (refer to DLVP Design Guide at www.cooperlighting.com for details)

Canada Options

- 347VAC 50/60Hz; 1% dimming on 0-10V analog control, for 500, 750, 1000, 1500, 2000, 2500, 3000, 3500, 4000 lumen models only
- 347V step down transformer factory installed with the standard "D010" 120V-277V, LED driver on 4500, 5000, 5500, 6000 lumen models only

Emergency Option

- Provides 90 minutes of standby lighting, meeting most life safety codes for egress lighting
- Available with integral or remote charge indicator and test switch
- Available Self-Test (self-diagnostic) with remote charge indicator and test switch
- Quick Spec emergency ordering option for quick-turn projects

Connected Lighting System

Two WaveLinX connected solutions to choose from. Refer to WaveLinX system specifications and application guides for details.

WaveLinX PRO Tilemount Sensor Kit

- WaveLinX PRO WTA tilemount sensor kit offers daylight dimming, PIR motion sensing, scene and zone configuration, automatic commissioning; and optional RLTS - Real Time Location Services available.

WaveLinX PRO Wireless Node

- WaveLinX PRO WPN wireless node provides luminaire-level control with scene and zone configuration without an integrated sensor; Connects wirelessly with daylight dimming sensor and PIR motion sensor if desired. Use with 0-10V driver only. **Note:** Not compatible with 347V or Chicago plenum.

WaveLinX LITE Tilemount Sensor Kit

- WaveLinX LITE WTK tilemount sensor kit offers daylight dimming and PIR motion sensing, scene and grouping configuration.

WaveLinX LITE Wireless Node

- WaveLinX LITE WLN wireless node provides luminaire level control with scene and zone configuration without an integrated sensor; Connects wirelessly with daylight dimming sensor and PIR motion sensor if desired. Use with 0-10V driver only. **Note:** Not compatible with 347V or Chicago plenum.

WaveLinX Tilemount Sensor Kits Application

- The WTA and WTK tilemount sensor kits include a control module mounted on the luminaire junction box via 1/2" knock-out, and a tilemount sensor on 54-inch whip; for ceiling installation by direct-mount spring clips or via mounting bracket in octagon ceiling boxes.
- The WTA and WTK tilemount sensor kits may be ordered as factory installed on the luminaire, or ordered separately as a field installed accessory kit.
- **Note: WaveLinX PRO devices are only compatible with the WaveLinX PRO system.**
- **Note: WaveLinX LITE devices are only compatible with the WaveLinX LITE system.**

Junction Box

- Galvanized steel junction box
- 20 in³ internal volume excluding voltage barrier
- 25 in³ internal total volume
- Voltage barrier for 0-10V dimming wires (occupies one 1/2" pry-out space)
- Listed for eight #12 AWG (four in, four out) 90°C conductors and feed-thru branch wiring
- Three 1/2" and two 3/4" trade size pry-outs available
- Three 4-port push wire nuts for mains voltage with 1-port for fixture connection

Compliance

- cULus Certified to UL 1598 / C22.2 No. 250.0, suitable for damp locations and wet locations in covered ceilings only
 - Emergency options provided with UL Listed emergency drivers to UL 924 / C22.2 No. 141, suitable for indoor/damp locations
 - IP20 - Above finished ceiling; IP65 - Below finished ceiling
 - Non-Insulated ceiling (Non-IC) rated for 2500, 3000, 3500, 4000, 4500, 5000, 5500, 6000 lumen models (insulation must be kept 3" from top and sides)
 - Insulated ceiling (IC) rated for 500, 750, 1000, 1500, 2000 lumen models and suitable for direct contact with air permeable insulation* (IC models are also suitable for Non-IC installations)
 - Non-IC marked spacing required for 4500, 5000, 5500, 6000 lumen models
 - Marked Spacing Center to Center of Adjacent Luminaires = 36"
 - Center of Luminaire to Building Member = 18"
 - Minimum overhead = 0.5"
 - Airtight per ASTM-E283-04
 - Suitable for use in clothes closets when installed in accordance with the NEC 410.16 spacing requirements
 - EMI/RFI emissions FCC CFR Title 47 Part 15 Class A at 120/277V
 - Contains no mercury or lead and RoHS compliant
 - Photometric testing completed in accordance of IES LM-79-08
 - Lumen maintenance projection in accordance of IES LM-80-08 and TM-21-11
 - 500, 750, 1,000, 1,500 and 2,000 lumen, 90 CRI, ICAT models may be used to comply with State of California Title 24 residential code, per JA8 certification standards
 - May be used to comply with State of California Title 24 non-residential code as a dimmable LED luminaire
 - ENERGY STAR® certified, reference certified light fixtures database
- *Not for use in direct contact with spray foam insulation, consult NEMA LSD57-2013

Warranty

- Five year limited warranty, consult website for details. www.cooperlighting.com/legal



Job Name:

New Training Facility - St. Tammany Fire Protection District No. 1
 Architect: DAMMON ENGINEERS INC (Slidell)
 Engineer: DAMMON ENGINEERS INC (Slidell)

Catalog Number:

HC615D010 HM60525930
 61MDCWF
 Notes:

Type:

F3

WK25-44042

HALO Commercial

HC6 | HM6 | 61 | 61PS

Photometric Data

[View IES files](#)

NARROW DISTRIBUTION - SPECULAR CLEAR FINISH, 2000 LUMEN MODEL, 80 CRI, 3500K

NARROW (55° BEAM*)	
Test Number	P581878
Housing	HC620D010
Module	HM60525835
Reflector	61NDC
Lumens	2228 Lm
Efficacy	111.4 Lm/W
SC	0.93
UGR	11.7

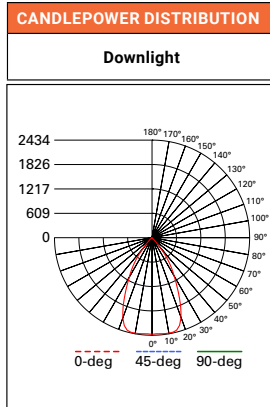

CONE OF LIGHT			
MH	FC	L	W
5.5'	80.2	5	5
7'	49.5	6.4	6.4
8'	37.9	7.4	7.4
9'	30	8.2	8.2
10'	24.3	9.2	9.2
12'	16.9	11	11

CANDELA TABLE	
Degrees Vertical	Candela
0	2427
5	2422
15	2405
25	1621
35	761
45	118
55	12
65	3
75	2
85	0
90	0

ZONAL LUMEN SUMMARY		
Zone	Lumens	% Fixture
0-30	1636	73.4
0-40	2098	94.2
0-60	2223	99.8
0-90	2228	100
90-180	0	0
0-180	2228	100

LUMINANCE	
Average Candela Degrees	Average 0° Luminance
45	9187
55	1118
65	376
75	318
85	0

MEDIUM DISTRIBUTION - SPECULAR CLEAR FINISH, 2000 LUMEN MODEL, 80 CRI, 3500K

MEDIUM (60° BEAM*)	
Test Number	P581875
Housing	HC620D010
Module	HM60525835
Reflector	61MDC
Lumens	2307 Lm
Efficacy	115.3 Lm/W
SC	1.06
UGR	11.8

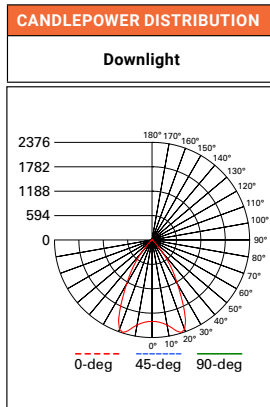

CONE OF LIGHT			
MH	FC	L	W
5.5'	68.7	5.6	5.6
7'	42.4	7.2	7.2
8'	32.5	8.2	8.2
9'	25.7	9.4	9.4
10'	20.8	10.4	10.4
12'	14.4	12.4	12.4

CANDELA TABLE	
Degrees Vertical	Candela
0	1998
5	2022
15	2307
25	1842
35	796
45	126
55	15
65	4
75	2
85	0
90	0

ZONAL LUMEN SUMMARY		
Zone	Lumens	% Fixture
0-30	1671	72.4
0-40	2163	93.8
0-60	2301	99.7
0-90	2307	100
90-180	0	0
0-180	2307	100

LUMINANCE	
Average Candela Degrees	Average 0° Luminance
45	9753
55	1395
65	571
75	318
85	0



Job Name:

New Training Facility - St. Tammany Fire Protection District No. 1
 Architect: DAMMON ENGINEERS INC (Slidell)
 Engineer: DAMMON ENGINEERS INC (Slidell)

Catalog Number:

HC615D010 HM60525930
 61MDCWF

Notes:

Type:

F3

WK25-44042

HALO Commercial

HC6 | HM6 | 61 | 61PS

Photometric Data

[View IES files](#)

WIDE DISTRIBUTION - SPECULAR CLEAR FINISH, 2000 LUMEN MODEL, 80 CRI, 3500K

WIDE (65° BEAM*)	
Test Number	P581885
Housing	HC620D010
Module	HM60525835
Reflector	61WDC
Lumens	2359 Lm
Efficacy	118 Lm/W
SC	1.28
UGR	11.6

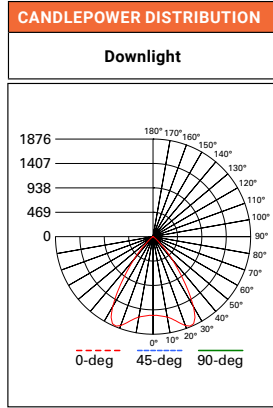

CONE OF LIGHT

MH	FC	L	W
5.5'	50.5	7	7
7'	31.2	8.8	8.8
8'	23.9	10.2	10.2
9'	18.8	11.4	11.4
10'	15.3	12.8	12.8
12'	10.6	15.4	15.4

CANDELA TABLE

Degrees Vertical	Candela
0	1526
5	1540
15	1685
25	1861
35	1027
45	252
55	32
65	6
75	2
85	0
90	0

ZONAL LUMEN SUMMARY

Zone	Lumens	% Fixture
0-30	1461	61.9
0-40	2105	89.2
0-60	2351	99.6
0-90	2359	100
90-180	0	0
0-180	2359	100

LUMINANCE

Average Candela Degrees	Average 0° Luminance
45	19506
55	3078
65	765
75	318
85	0

*Value are nominal with specular clear reflectors, other finishes and field results may vary.
 SC = Spacing Criteria
 UGR = Unified Glare Rating

Photometric Multipliers (Nominal Lumen Values)

500 Lumen	750 Lumen	1000 Lumen	1500 Lumen	2000 Lumen	2500 Lumen	3000 Lumen	3500 Lumen
0.33	0.44	0.54	0.74	1.00	1.12	1.46	1.76

4000 Lumen	4500 Lumen	5000 Lumen	5500 Lumen	6000 Lumen
1.81	2.17	2.28	2.38	2.65

Multipliers for relative lumen values with other series models.

Color Finish Multipliers

Finish code	C	H	W/WB	BB
Finish	Specular Clear	Semi-Specular	Matte White White Baffle	Black Baffle
Multiplier	1.00	0.92	0.91	0.82

Multipliers for relative lumen values with other color finishes.

CCT Multipliers - 80CRI

2700K	3000K	3500K	4000K	5000K
0.92	0.98	1.00	1.03	1.03

Multipliers for relative lumen values with other series color temperatures.

CCT Multipliers - 90CRI

2700K	3000K	3500K	4000K	5000K
0.77	0.84	0.89	0.90	0.90

Multipliers for relative lumen values with other series color temperatures.



Job Name:

New Training Facility - St. Tammany Fire Protection District No. 1
 Architect: DAMMON ENGINEERS INC (Slidell)
 Engineer: DAMMON ENGINEERS INC (Slidell)

Catalog Number:

HC615D010 HM60525930
 61MDCWF
 Notes:

Type:

F3

WK25-44042

HALO Commercial

HC6 | HM6 | 61 | 61PS

Photometric Data

[View IES files](#)

WALL WASH DISTRIBUTION - SPECULAR CLEAR FINISH, 2000 LUMEN MODEL, 80 CRI, 3500K

WALL WASH	
Test Number	P581882
Housing	HC620D010
Module	HM60525835
Reflector	61RWWC
Lumens	2179 Lm
Efficacy	109 Lm/W
SC	1.15

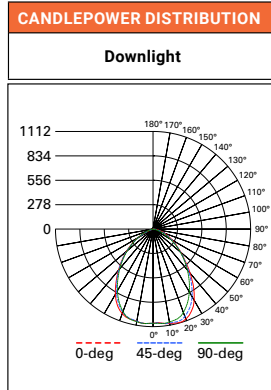

CANDELA TABLE	
Degrees Vertical	Candela
0	1080
5	1081
15	1112
25	1034
35	800
45	514
55	319
65	184
75	85
85	12
90	0

ZONAL LUMEN SUMMARY		
Zone	Lumens	% Fixture
0-30	849	39
0-40	1313	60.2
0-60	1978	90.8
0-90	2179	100
90-180	0	0
0-180	2179	100

LUMINANCE	
Average Candela Degrees	Average 0° Luminance
45	39810
55	30479
65	23907
75	17983
85	7359

SC = Spacing Criteria, nominal for specular clear reflector, other finishes and field results may vary.

SINGLE UNIT FOOTCANDLES							
2.5' from wall (distance from fixture along wall)							
1	19.3	13.8	6.1	2.2	0.7	0.3	0.1
2	29.1	22.6	12.3	5.7	2.5	1.2	0.6
3	27.6	22.5	13.8	7.3	3.7	1.9	1
4	21	18.2	12.4	7.4	4.2	2.4	1.4
5	14.4	13.1	9.9	6.6	4.1	2.5	1.6
6	9.7	9.1	7.5	5.5	3.7	2.5	1.6
7	6.7	6.4	5.5	4.3	3.2	2.2	1.5
8	4.7	4.6	4.1	3.4	2.7	2	1.4
9	3.4	3.3	3.1	2.7	2.2	1.7	1.3
10	2.5	2.5	2.4	2.1	1.8	1.4	1.1

MULTIPLE UNIT FOOTCANDLES						
2.5' from wall (Distance from fixture along 3')			2.5' from wall (Distance from fixture along 4')			
1	21.5	19.1	21.5	20	12.1	20
2	34.7	34.4	34.7	31.6	24.6	31.6
3	34.9	36	34.9	31.3	27.6	31.3
4	28.4	30.7	28.4	25.2	24.8	25.2
5	21	23.2	21	18.6	19.8	18.6
6	15.2	16.8	15.2	13.4	15	13.4
7	11	12	11	9.9	11	9.9
8	8.1	8.7	8.1	7.4	8.2	7.4
9	6.1	6.5	6.1	5.6	6.2	5.6
10	4.6	4.9	4.6	4.3	4.7	4.3

Photometric Multipliers (Nominal Lumen Values)

500 Lumen	750 Lumen	1000 Lumen	1500 Lumen	2000 Lumen	2500 Lumen	3000 Lumen	3500 Lumen
0.33	0.44	0.54	0.74	1.00	1.12	1.46	1.76

4000 Lumen	4500 Lumen	5000 Lumen	5500 Lumen	6000 Lumen
1.81	2.17	2.28	2.38	2.65

Multipliers for relative lumen values with other series models.

Color Finish Multipliers

Finish code	C	H	W/WB	BB
Finish	Specular Clear	Semi-Specular	Matte White White Baffle	Black Baffle
Multiplier	1.00	0.92	0.91	0.82

Multipliers for relative lumen values with other color finishes.

CCT Multipliers - 80CRI

2700K	3000K	3500K	4000K	5000K
0.92	0.98	1.00	1.03	1.03

Multipliers for relative lumen values with other series color temperatures.

CCT Multipliers - 90CRI

2700K	3000K	3500K	4000K	5000K
0.77	0.84	0.89	0.90	0.90

Multipliers for relative lumen values with other series color temperatures.



Note: Refer to IES files for more product data.



Job Name:

New Training Facility - St. Tammany Fire Protection District No. 1
 Architect: DAMMON ENGINEERS INC (Slidell)
 Engineer: DAMMON ENGINEERS INC (Slidell)

Catalog Number:

HC615D010 HM60525930
 61MDCWF
 Notes:

Type:

F3

WK25-44042

HALO Commercial

HC6 | HM6 | 61 | 61PS

Energy & Performance Data

COLOR METRICS - TM-30-15 & CRI/CIE (3500K)

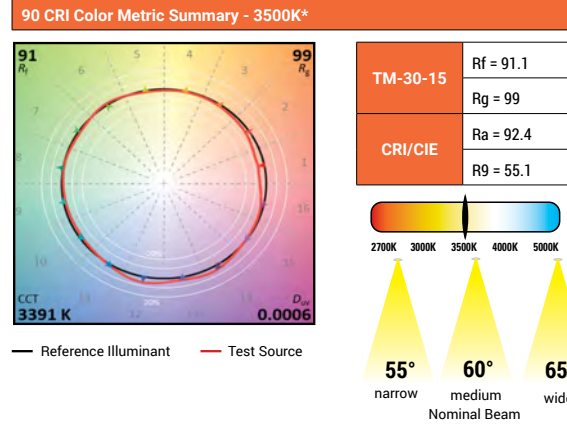
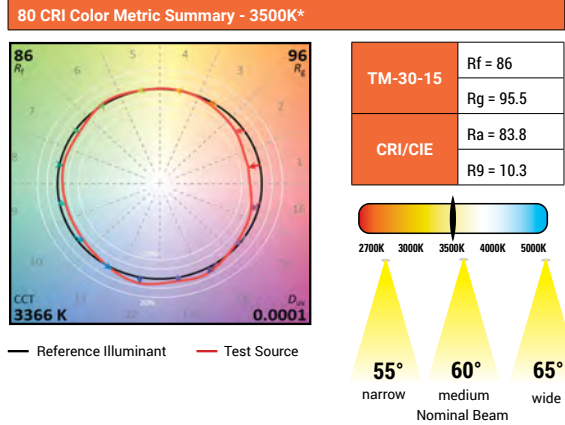

* Color values are based on 61WDWB reflector, other finishes and field results may vary.

ENERGY DATA

Series	500 lumen		750 lumen		1000 lumen		1500 lumen		2000 lumen	
Input Voltage 120-277VAC	120V	277V	120V	277V	120V	277V	120V	277V	120V	277V
Input Current (A)	0.051	0.026	0.067	0.036	0.083	0.039	0.119	0.053	0.171	0.077
Input Power (W)	6.1	6.5	7.9	8.3	10	10.4	14.5	14.5	20.9	20.6
In-rush (A)	1.9	8.4	2	8.4	2.2	8.5	2.7	8.5	2.1	9.7
Inrush duration (µs)	251	135	237	133	250	134	250	139	245	131
THD (%)	6.2	13.5	7.4	8.8	5.4	10.3	10	6.7	6.5	7.9
PF	≥ 0.99	≥ 0.9	≥ 0.98	≥ 0.92	≥ 0.99	≥ 0.95	≥ 0.99	≥ 0.97	≥ 0.99	≥ 0.96

Series	2500 lumen		3000 lumen		3500 lumen		4000 lumen		4500 lumen	
Input Voltage 120-277VAC	120V	277V	120V	277V	120V	277V	120V	277V	120V	277V
Input Current (A)	0.23	0.103	0.24	0.107	0.292	0.152	0.351	0.159	0.384	0.172
Input Power (W)	27.5	27.5	28.6	28.5	34.6	35.1	42.1	42.1	45.9	45.6
In-rush (A)	2.5	5.6	2.5	11.6	3.4	13.9	3.1	14.7	3.1	14.8
Inrush duration (µs)	232	123	216	111	183	95	200	98	202	100
THD (%)	6.5	8.1	7.8	8.3	5.6	10	4.1	9.5	4.5	8.5
PF	≥ 0.99	≥ 0.96	≥ 0.99	≥ 0.96	≥ 0.99	≥ 0.93	≥ 0.99	≥ 0.94	≥ 0.99	≥ 0.95

Series	5000 lumen		5500 lumen		6000 lumen	
Input Voltage 120-277VAC	120V	277V	120V	277V	120V	277V
Input Current (A)	0.419	0.186	0.457	0.201	0.489	0.214
Input Power (W)	50.1	49.5	54.6	53.7	58.4	57.4
In-rush (A)	3.1	15	3.2	14.8	3.4	14.8
Inrush duration (µs)	202	117	196	131	192	121
THD (%)	5.5	7.6	7	7.2	8.1	7.2
PF	≥ 0.99	≥ 0.96	≥ 0.99	≥ 0.96	≥ 0.99	≥ 0.97

Minimum starting temperature -30°C (-22°F)*
 (Nominal input 120-277VAC & 100% of rated output power)

Sound Rating: Class A standards

Notes:

* Emergency Battery packs are rated for a minimum starting temperature of 0°C.





Job Name:

New Training Facility - St. Tammany Fire Protection District No. 1
 Architect: DAMMON ENGINEERS INC (Slidell)
 Engineer: DAMMON ENGINEERS INC (Slidell)

Catalog Number:

HC615D010 HM60525930

61MDCWF

Notes:

Type:

F3

WK25-44042

HALO Commercial

HC6 | HM6 | 61 | 61PS

Dimensional and Mounting Details

NEW CONSTRUCTIONS - LOW LUMEN 500 – 2500 LUMENS

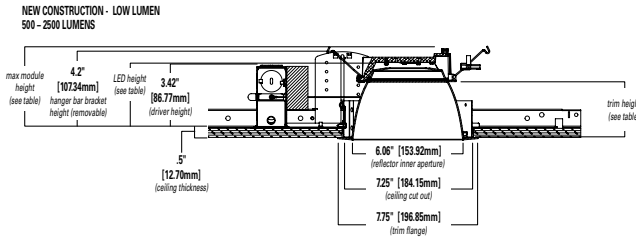

Low Lumen (500 – 2500 Lumens)*

Distribution	Max. Module Height	Trim Height	LED Height
Narrow	4.5"	3.4"	3.8"
Medium	4.6"	3.5"	3.9"
Wide	4.4"	3.3"	3.7"
Baffle	4.4"	3.3"	3.7"



Low Lumen Module

*Max. height w/removable hanger bar bracket 4.2"

NEW CONSTRUCTIONS - MID LUMEN 3000 – 4000 LUMENS

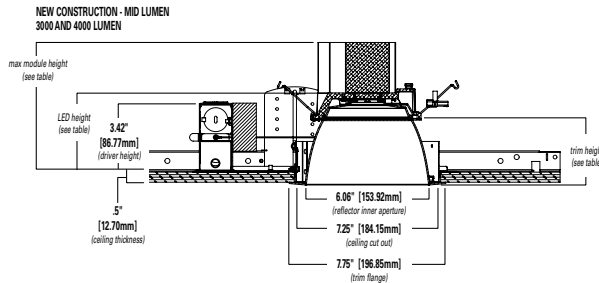

Mid Lumen (3000 – 4000 Lumens)

Distribution	Max. Module Height	Trim Height	LED Height
Narrow	6.6"	3.4"	3.8"
Medium	6.7"	3.5"	3.9"
Wide	6.5"	3.3"	3.7"
Baffle	6.5"	3.3"	3.7"



Mid Lumen Module

NEW CONSTRUCTIONS - HIGH LUMEN 4500 – 6000 LUMENS

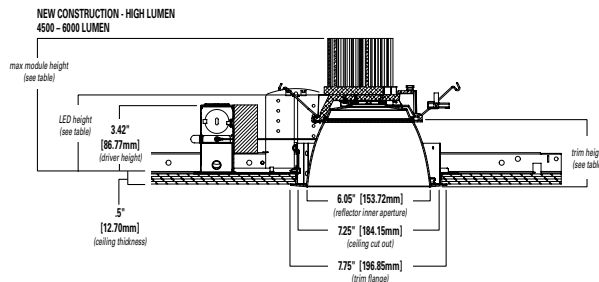

High Lumen (4500 – 6000 Lumens)

Distribution	Max. Module Height	Trim Height	LED Height
Narrow	6.9"	3.4"	3.8"
Medium	7.0"	3.5"	3.9"
Wide	6.8"	3.3"	3.7"
Baffle	6.8"	3.3"	3.7"



High Lumen Module



Job Name:

New Training Facility - St. Tammany Fire Protection District No. 1
 Architect: DAMMON ENGINEERS INC (Slidell)
 Engineer: DAMMON ENGINEERS INC (Slidell)

Catalog Number:

HC615D010 HM60525930
 61MDCWF

Notes:

Type:

F3

WK25-44042

HALO Commercial

HC6 | HM6 | 61 | 61PS

Connected Solutions

WaveLinx LITE - WTK Tilemount Sensor

WaveLinx LITE devices only compatible with the WaveLinx LITE system.

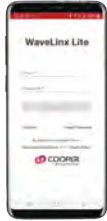

- Intuitive Android™ or Apple® iOS® app for basic system code compliant set up and configuration via Bluetooth
- Up to 28 unique areas per project site (WaveLinx LITE Bluetooth network)
- Up to 50 devices for an area, any one of 16 control zones, up to 6 occupancy sets, and custom lighting scenes
- Automatic occupancy or vacancy, sensor sensitivity, daylight dimming, etc. configurable through the app
- Refer to the WaveLinx system specifications for details



WaveLinx LITE WTK Tilemount Wiring Diagram

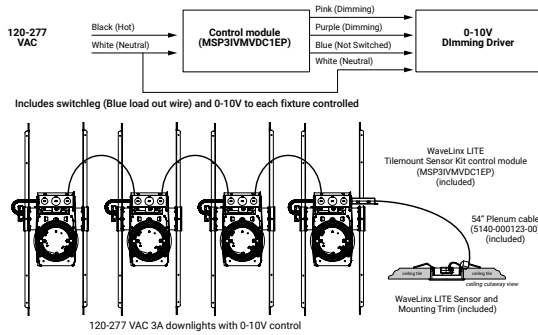

WaveLinx LITE Bluetooth Enabled System



WaveLinx PRO – WTA Tilemount Sensor

WaveLinx PRO devices only compatible with the WaveLinx PRO system.



- WaveLinx PRO tilemount functionality configures zones and customizes settings from one secure mobile app
- Automatic code commissioning that meets the strictest codes
- Fixtures and sensors integrate with Wireless Area Controller, Wall Stations, and Control Devices
- Stand-Alone Offices or Entire Building Network Installations



WaveLinx mobile app settings

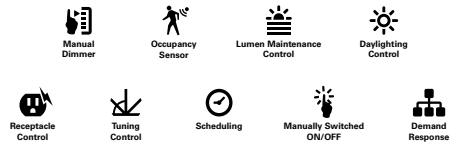

WaveLinx WTA Tilemount Wiring Diagram

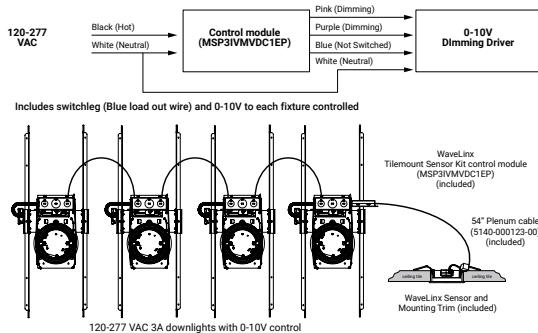

WaveLinx CORE Building Management Integration

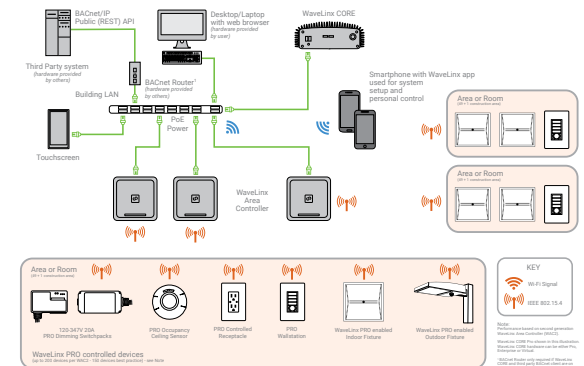



Job Name:

New Training Facility - St. Tammany Fire Protection District No. 1
 Architect: DAMMON ENGINEERS INC (Slidell)
 Engineer: DAMMON ENGINEERS INC (Slidell)

Catalog Number:

HC615D010 HM60525930
 61MDCWF

Notes:

Type:

F3

WK25-44042

HALO Commercial

HC6 | HM6 | 61 | 61PS

Connected Solutions



WaveLinx LITE Wireless Node - WLN

- Intuitive Android™ or Apple® iOS® app for basic system code compliant set up and configuration via Bluetooth
- Up to 28 unique areas per project site (WaveLinx LITE Bluetooth network)
- Up to 50 devices for an area, any one of 16 control zones, up to 6 occupancy sets, and custom lighting scenes
- Refer to the WaveLinx system specifications for details

WaveLinx mobile app settings



WaveLinx LITE devices only compatible with the WaveLinx LITE system.

WaveLinx LITE Wireless Node (WLN) Wiring Diagram

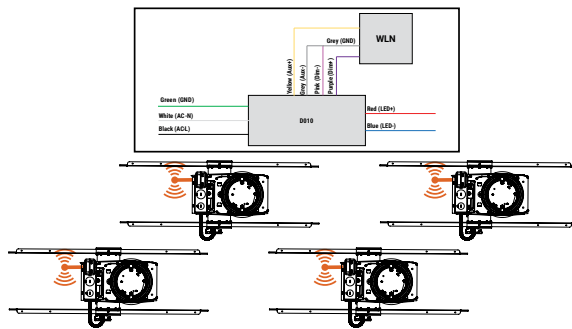

WaveLinx LITE Bluetooth Enabled System



WaveLinx PRO Wireless Node - WPN

- WaveLinx Wireless functionality configures zones and customizes settings from one secure mobile app
- Automatic code commissioning that meets the strictest codes
- Fixtures and sensors integrate with WaveLinx Area Controller, Wall Stations, and Control Devices
- Stand-Alone Offices or Entire Building Network Installations

WaveLinx PRO devices only compatible with the WaveLinx PRO system.



WaveLinx mobile app settings

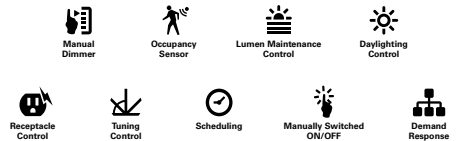

WaveLinx PRO Wireless Node (WPN) Wiring Diagram

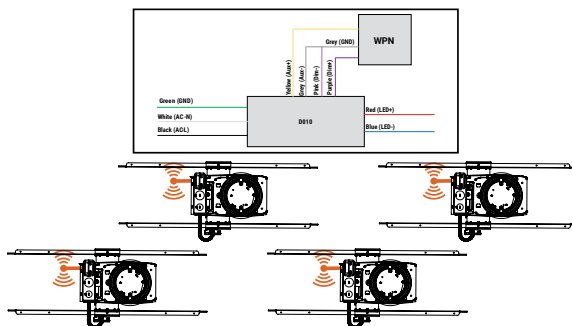

WaveLinx CORE Building Management Integration

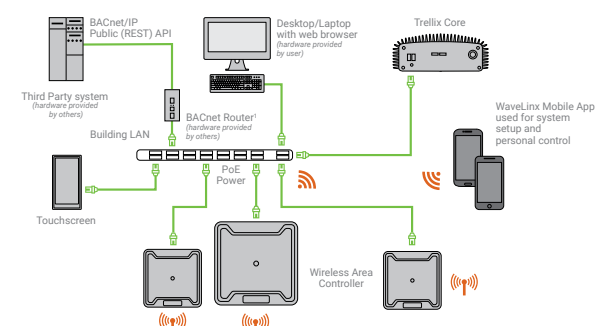

Cooper Lighting Solutions
 1121 Highway 74 South
 Peachtree City, GA 30269
 P: 770-486-4800
 www.cooperlighting.com

© 2024 Cooper Lighting Solutions
 All Rights Reserved.
 Specifications and dimensions
 subject to change without notice.



Job Name:

New Training Facility - St. Tammany Fire Protection District No. 1
 Architect: DAMMON ENGINEERS INC (Slidell)
 Engineer: DAMMON ENGINEERS INC (Slidell)

Catalog Number:

4909-BN-4

Notes:

Type:

F4

WK25-44042

4909
120V

Catalog #:		Type
Project:		Date
Prepared by:		

Square Shade Vanity Lights - E26 A19 LED Lamps Included



DESCRIPTION

See yourself in the best light with the 4909 Series A19 LED Vanity Light that can be mounted in direct or indirect positions. This vanity is damp location rated and is energy efficient. Choose from 2-light, 3-light, or 4-light configurations for any type of application.

DESIGN FEATURES

Construction

- Heavy duty, stainless steel construction
- Frosted Glass Square Shade

Dimensions

- 4909-2: 11-3/4" L x 8-3/4" H x 7" D
- 4909-3: 19-1/2" L x 8-3/4" H x 7" D
- 4909-4: 27-1/8" L x 8-3/4" H x 7" D

Electrical

- 120V-60Hz
- Dimmable TRIAC, 10-100%
- E26 Socket | 9W A19 LED Lamps Included
- 50,000 hour projected life
- 3000K | 80 CRI

Certifications

- cETLus listed for damp locations
- CEC JA8 Compliant *
- 1 Year Limited Warranty

Installation

- Quick and easy wall mount installation
- Fixture can be mounted with glass shades facing up or down
- Back plate is 5" x 6" and will accommodate most J-Boxes

Lens

- Frosted Glass Lens Replacement: 4902-G

ORDERING GUIDE

Example: 4909BN-3

Model #	Finish	# of Lights
4909	BN	
4909	BN : Brushed Nickel	-2 : 2 lights -3 : 3 lights -4 : 4 lights

* Included A19 LED lamp listed on CEC JA8 website as L9-A19DG-9W-30

TEL: 800.937.6925 | Fax: 800.207.9509 | www.rplighting.com

Specifications and dimensions subject to change without notice.



10/4/24 R2





Job Name:

New Training Facility - St. Tammany Fire Protection District No. 1
 Architect: DAMMON ENGINEERS INC (Slidell)
 Engineer: DAMMON ENGINEERS INC (Slidell)

Catalog Number:

APX7RG

Notes:

Type:

EX

WK25-44042

Project		Catalog #		Type	
Prepared by		Notes		Date	



Sure-Lites

All-Pro APX RG Series

LED Exit Sign

Thermoplastic Housing with Selectable Red or Green Faces

AC only or Battery Backup Models

Typical Applications

Office • Education • Healthcare • Hospitality • Retail • Industrial • Manufacturing

Interactive Menu

- Order Information page 2
- Product Warranty

Product Certification

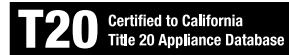

Product Features



Top Product Features

- Field selectable red or green LEDs and inserts for letter color selection
- Field selectable single or double faces with snap-out/snap-in chevrons
- Ceiling, wall or end mount
- Dual voltage input 120/277 VAC, 60Hz
- APX7 battery backup models have maintenance free nickel cadmium batteries
- Universal J-box mounting pattern
- High impact, 5VA flame resistant, UV resistant thermoplastic housing in white or black
- 90 minute run time for battery backup versions if power is lost

Dimensional and Mounting Details

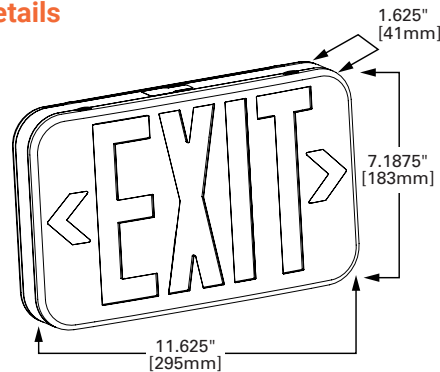

**Job Name:**

New Training Facility - St. Tammany Fire Protection District No. 1
 Architect: DAMMON ENGINEERS INC (Slidell)
 Engineer: DAMMON ENGINEERS INC (Slidell)

Catalog Number:

APX7RG

Notes:

Type:**EX**

WK25-44042

Sure-Lites**APX RG****Ordering Information**SAMPLE ORDER NUMBER: **APX7RG****Order Information**

APX7		RG	
-------------	--	-----------	--

Series	Face Options	Letter Color	Housing Color	Catalog Examples
APX6=AC only (no battery)	[Blank]=Universal	RG=Field Selectable Red or Green	[Blank]=White BK=Black	APX6RG, APX6RGBK, APX7RG, APX7RGBK
APX7=Nickel Cadmium battery	[Blank]=Universal	RG=Field Selectable Red or Green	[Blank]=White BK=Black	

Catalog Number	Description	UPC	Case Count	Pallet Quantity
APX6RG	All-Pro Exit, Red Green Selectable, AC Only, White Finish	080083280964	6	270
APX7RG	All-Pro Exit, Red Green Selectable, Nickel Cadmium Battery Backup, White Finish	080083281107	6	270
APX6RGBK	All-Pro Exit, Red Green Selectable, AC Only, Black Finish	080083280988	6	270
APX7RGBK	All-Pro Exit, Red Green Selectable, Nickel Cadmium Battery Backup, Black Finish	080083281121	6	270

Description

The LED APX series is a UL924 code compliant solution for indoor exit requirements. It is available as AC only (APX6) or battery backup (APX7) with a maintenance free nickel cadmium battery. The battery backup version will operate for a minimum of 90 minutes during a power outage.

The APXRG exit series are supplied with both red and green LEDs and red and green face inserts to provide deep letter colors and illumination uniformity. The series are supplied pre-set to red letters and are easily changed to green letters in the field. The APXRG series configurable single or double faces, snap-in/snap-out directional chevrons and universal surface ceiling, wall and end mounting make it a true universal exit solution for stocking and installation needs. The high impact, UV resistant, 5VA flame resistant thermoplastic housings resists discoloration due to age or UV exposure for maximum durability. Housing finishes are available in white or black for multiple design requirements.

Product Specifications**Illumination Source Data**

- Long life LEDs provide uniform, diffuse illumination for the EXIT face
- RG models have field selectable red or green LEDs
- Battery backup models (APX7) LED sources are brighter in emergency mode
- LED sources provide low operating costs and no maintenance

Electrical

- Dual Voltage Input 120/277VAC 60Hz
- Solid-State voltage limited charger (APX7)
- Brownout circuit (APX7)
- Test switch / Power indicator light (APX7)

Housing Construction

- All components are injection molded, color stable, high impact, 5VA flame resistant, thermoplastic material
- UV stabilized to resist discoloration due to age and ultraviolet radiation
- APX_RG series LEDs and lens panels are field selectable red or green. APX_RG exits series come with LEDs set to "red" with red inserts installed. The APX_RG series can be easily converted to "green" LEDs and inserts in the field
- Available in a white or black finish
- Components are of snap-fit construction to facilitate under 5-minute installation
- Reinforcing ribs throughout to provide maximum strength connections

- All components including battery and electronics are located inside the exit housing
- Snap-out or snap-in chevron directional indicators have full 3/4" stroke
- Universal exits can be field configured as single face or double face
- Snap-fit canopy with mounting screws included with all exits
- Exit can be ceiling, wall, or end mounted
- Universal J-box mounting pattern
- Operating temperature range 0°C to 50°C

Solid-State Charger (APX7)

- 120/277 VAC, voltage regulated solid-state charger
- High charge rate immediately following power restoration of AC current after a power failure
- Charge circuit reacts to the condition of the battery and regulates the charging process in order to maintain peak battery capacity and maximize battery life
- Solid-state construction recharges the battery following a power failure in accordance with UL 924

Brownout Circuit (APX7)

- Monitors the flow of AC current
- Activates the emergency lighting system when a predetermined reduction/dip of AC power occurs (a dip in voltage will cause most ballasted products to extinguish, causing loss of normal lighting even though a total power failure has not occurred)

Test Switch/Power Indicator Light (APX7)

- Switch located on the bottom of the exit permits the activation of the emergency circuit for complete operational systems check
- Indicator light provides visual assurance that the AC power is on

Battery

- Sealed nickel cadmium
- Maintenance free, long life
- Full recharge time: 24 hrs (max.)

Code Compliance

- UL 924 Listed
- UL Damp Location Listed
- Life Safety NFPA 101
- NEC/OSHA
- California Energy Code compliant

Lamp Data

- AC LED: Long life LED lamps provide uniform diffused illumination
- DC: LED DC lamps (Brighter in emergency mode, APX7)

Limited Warranty

- Five-year limited warranty
- Seven-year prorated battery limited warranty

Energy and Performance Data

Maximum power consumption under all charge conditions:

Sealed Nickel Cadmium Battery LED Exits - Red/Green Selectable

Input Power	Input Current (Max.):	Power Factor:
120V = 1.34W	120V = 0.092A	120V = >0.122
277V = 3.12W	277V = 0.093A	277V = >0.121

AC Only LED Exits - Red/Green Selectable

Input Power	Input Current (Max.):	Power Factor:
120V = 1.14W	120V = 0.091A	120V = >0.104
277V = 2.72W	277V = 0.090A	277V = >0.109



Cooper Lighting Solutions
 1121 Highway 74 South
 Peachtree City, GA 30269
 P: 770-486-4800
 www.cooperlighting.com

© 2023 Cooper Lighting Solutions
 All Rights Reserved.

Specifications and dimensions
 subject to change without notice.

PS50553023 page 2
 November 30, 2023 1:32 PM



Job Name:

New Training Facility - St. Tammany Fire Protection District No. 1
 Architect: DAMMON ENGINEERS INC (Slidell)
 Engineer: DAMMON ENGINEERS INC (Slidell)

Catalog Number:

SEL50

Notes:

Type:

EM

WK25-44042

Project		Catalog #		Type	
Prepared by		Notes		Date	



Sure-Lites

SEL Emergency Light

LED Emergency Light
 Up to 25, 50 or 60 feet egress coverage
 Adjustable Optic
 Self-Diagnostics Options
 Remote Capacity Options

Typical Applications

Office • Education • Healthcare • Hospitality • Retail • Manufacturing

Interactive Menu

- Order Information page 2
- Photometric Data page 4
- Self Diagnostics page 6
- Product Warranty

Product Certification



T20 Certified to California Title 20 Appliance Database

Product Features



Top Product Features

- Emergency egress coverage of 25 feet to 60 feet
- Total system coverage of 193 feet with remote capable versions
- Long life LED source with adjustable optics
- Sealed Nickel Cadmium battery
- Patented EZ hang and EZ Key features facilitate installation
- Multi-voltage input 120/240/277 VAC

Dimensional Details

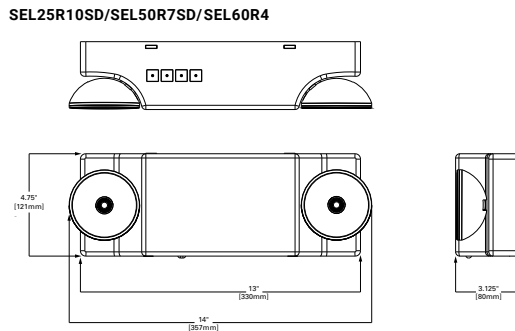
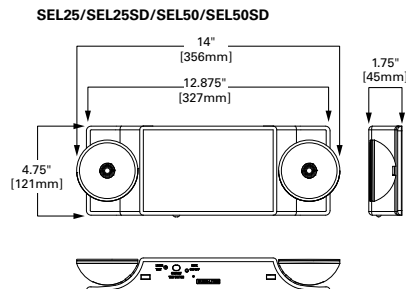



Job Name:
 New Training Facility - St. Tammany Fire Protection District No. 1
 Architect: DAMMON ENGINEERS INC (Slidell)
 Engineer: DAMMON ENGINEERS INC (Slidell)

Catalog Number:
 SEL50

Notes:

Type:

EM

WK25-44042

Sure-Lites **SEL25/SEL50/SEL60**

Catalog Logic for Non-Remote Capable Versions

SAMPLE ORDER NUMBER: **SEL50**

SEL	50					
Series	Coverage	Battery	Color	Self Diagnostic	Head Shape	Full Catalog Options
SEL=LED Emergency Light	25=25 feet 50=50 feet	__=NiCad	__=White	__=No Self Diagnostic SD=Self Diagnostic	__=Circular SQ=Square	SEL25, SEL25SQ, SEL25SD, SEL25SDSQ, SEL50, SEL50SQ, SEL50SD, SEL50SDSQ
Series	Coverage	Battery	Color	Self Diagnostic	Head Shape	Full Catalog Options
SEL=LED Emergency Light	25=25 feet	__=NiCad	BK=Black	SD=Self Diagnostic (standard)	__=Circular	SEL25BKSD,
SEL=LED Emergency Light	50=50 feet	__=NiCad	BK=Black	SD=Self Diagnostic (standard)	__=Circular	SEL50BKSD

Catalog Logic for Remote Capable Versions

SAMPLE ORDER NUMBER: **SEL25R10SD, SEL50R7SD, SEL60R4**

Series	Spacing	Battery	Remote Capacity	Color	Self Diagnostic	Full Catalog Options
SEL=LED Emergency Light	25=25 feet	__=NiCad	R10=10 watts	__=White BK=Black	SD=Self Diagnostic (standard)	SEL25R10SD SEL25R10BKSD
Series	Coverage	Battery	Remote Capacity	Color	Self Diagnostic	Full Catalog Options
SEL=LED Emergency Light	50=50 feet	__=NiCad	R7=7 watts	__=White BK=Black	SD=Self Diagnostic (standard)	SEL50R7SD SEL50R7BKSD
Series	Coverage	Battery	Remote Capacity	Color	Self Diagnostic	Full Catalog Options
SEL=LED Emergency Light	60=60 feet	__=NiCad	R4=4 watts	__=White	__=No SD SD=Self Diagnostic	SEL60R4 SEL60R4SD
Series	Coverage	Battery	Remote Capacity	Color	Self Diagnostic	Full Catalog Options
SEL=LED Emergency Light	60=260 feet	__=NiCad	R4=14 watts	BK=Black	SD=Self Diagnostic (standard)	SEL60R4BKSD

Emergency Egress Coverage; fixture spacing

Catalog Number	Output Lumens	0.1fc minimum		1fc minimum	
		7.5 foot height	20 foot height	7.5 foot height	20 foot height
SEL25	108	25 feet	12 feet	14 feet	12 feet
SEL50	218	50 feet	30 feet	21 feet	20 feet
SEL60	309	60 feet	52 feet	24 feet	30 feet

Electrical Characteristics During Charging Mode

SEL25 / SEL50 / SEL60

Model	120 volt			277 volt		
	Power (W)	Current (A)	PF	Power (W)	Current (A)	PF
SEL25	0.6	0.07	0.06	0.64	0.07	0.03
SEL25SD	0.6	0.07	0.07	0.67	0.07	
SEL50	1.0	0.15	0.05	1.02	0.14	
SEL50SD	1.2	0.15	0.06	1.19	0.14	
SEL60R4	1.7	0.25	0.06	1.62	0.21	
SEL60R4SD	2	0.3	0.07	1.8	0.2	
SEL25R10SD	2	0.3	0.07	1.8	0.2	
SEL50R7SD	2	0.3	0.07	1.8	0.2	



Job Name:

New Training Facility - St. Tammany Fire Protection District No. 1
 Architect: DAMMON ENGINEERS INC (Slidell)
 Engineer: DAMMON ENGINEERS INC (Slidell)

Catalog Number:

SEL50

Notes:

Type:

EM

WK25-44042

Sure-Lites **SEL25/SEL50/SEL60**

Remote System Design Guidelines

SEL25 / SEL50 / SEL60

SEL Series Remote								
		Single Head Remotes				Double Head Remotes		
		SRPA	SRP13/SRM13	SRP25/SRM25	SRP30/SRM30	SRP25D/SRM25D	SRP50D/SRM50D	SRP60D/SRM60D
Watts Consumed		3.5	1.25	2.5	4.1	2.5	5	8.2
Catalog Number	Remote Watts Available	# of SRPA Remotes Fixture Will Power	# of SRP/SRM13 Remotes Fixture Will Power	# of SRP/SRM25 Remotes Fixture Will Power	# of SRP/SRM30 Remotes Fixture Will Power	# of SRP25D/SRM25D Remotes Fixture Will Power	# of SRP50D/SRM50D Remotes Fixture Will Power	# of SRP60D/SRM60D Remotes Fixture Will Power
SEL60R4	4	1	3	1	NA	1	NA	NA
SEL60R4SD	4	1	3	1	NA	1	NA	NA
SEL60R4BKSD	4	1	3	1	NA	1	NA	NA
SEL60R4BK	4	1	3	1	NA	1	NA	NA
SEL50R7SD	7	2	5	2	1	2	1	NA
SEL50R7BKSD	7	2	5	2	1	2	1	NA
SEL25R10SD	10	2	8	4	2	4	2	1
SEL25R10BKSD	10	2	8	4	2	4	2	1



SRP



SRPD



SRM



SRMD



SRPA WHITE



SRPA BLACK



SRPA BRONZE



SRPA SILVER



Job Name:
 New Training Facility - St. Tammany Fire Protection District No. 1
 Architect: DAMMON ENGINEERS INC (Slidell)
 Engineer: DAMMON ENGINEERS INC (Slidell)

Catalog Number:
 SEL50

Notes:

Type:

EM

WK25-44042

Sure-Lites **SEL25/SEL50/SEL60**

Remote System Design Guidelines

LEM Series Remote Wattage Consumption					
Catalog Number	Single Head Remotes		Double Head Remotes		Watts Consumed
	LEMR1	LEMWR1	LEMR2	LEMWR2	
	1.4	1.4	2.8	2.8	

LEM Series Remote Capacity					
Catalog Number	Remote Watts Available	# of LEMR1 Remotes Fixture Will Power	# of LEMWR1 Remotes Fixture Will Power	# of LEMR2 Remotes Fixture Will Power	# of LEMWR2 Remotes Fixture Will Power
SEL25R10SD	10	7	7	3	3
SEL25R10BKSD	10	7	7	3	3
SEL50R7SD	7	5	5	2	2
SEL50R7BKSD	7	5	5	2	2
SEL60R4	4	2	2	1	1
SEL60R4SD	4	2	2	1	1
SEL60R4BKSD	4	2	2	1	1

Photometry

View IES files

SEL25

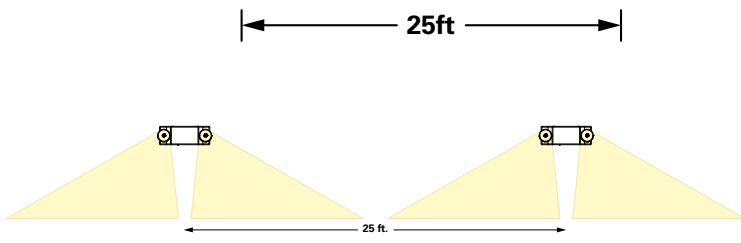
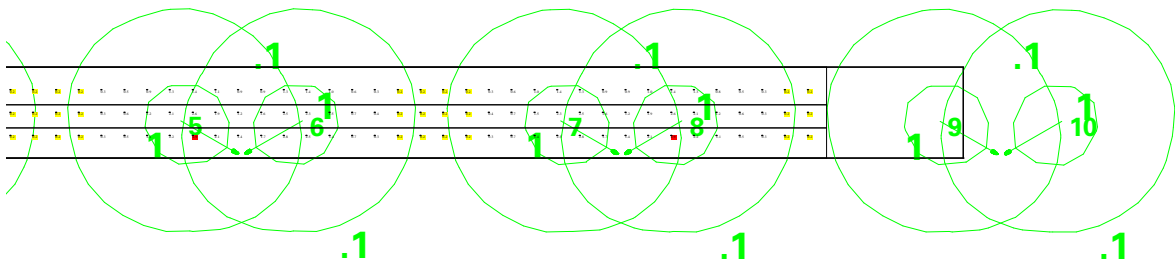

X	Y	Z	Orient	Tilt
-0.5	0.25	7.5	125	27
0.5	0.25	7.5	55	27
16.5	0.211	7.5	125	27
17.5	0.212	7.5	55	27
33.5	0.172	7.5	125	27
34.5	0.173	7.5	55	27
50.5	0.132	7.5	125	27
51.5	0.135	7.5	55	27
67.5	0.093	7.5	125	27
68.5	0.096	7.5	55	27
84.5	0.054	7.5	125	27
85.5	0.058	7.5	55	27
101.5	0.015	7.5	125	27
102.5	0.019	7.5	55	27

***The "Rule of Thumb" spacing guidelines are designed to achieve 1 foot-candle average and 0.1 foot-candle minimum with a 40:1 maximum/minimum ratio. The corridor used is 100 feet long, 9 foot ceiling with a 6 foot wide walkway and 3 foot path of egress. The reflectances are 80% ceiling, 50% walls and 20% floors. The fixture mounting height is 7.5 feet. Cooper Lighting Solutions assumes no responsibility for local requirements or specific project variables. This is a guideline to be used as a design aid, not as guarantee of any code compliance.



Job Name:
 New Training Facility - St. Tammany Fire Protection District No. 1
 Architect: DAMMON ENGINEERS INC (Slidell)
 Engineer: DAMMON ENGINEERS INC (Slidell)

Catalog Number:
 SEL50

Notes:

Type:

EM

WK25-44042

Sure-Lites **SEL25/SEL50/SEL60**

Photometry

SEL50

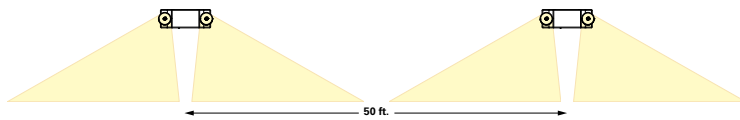
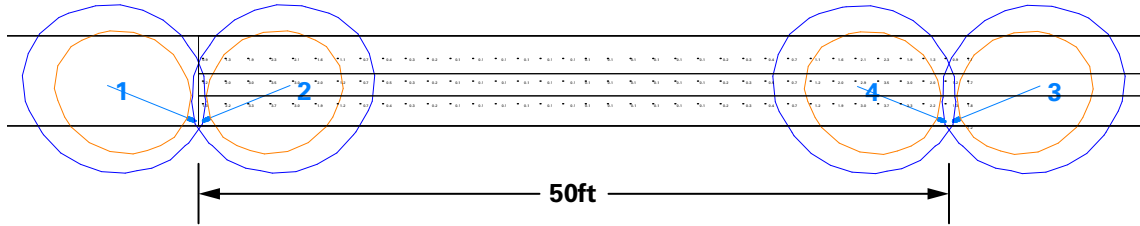

X	Y	Z	Orient	Tilt
24.25	0.33	7.5	158	40
24.75	0.33	7.5	22	40
74.75	0.3	7.5	22	40
74.25	0.292	7.5	158	40

SEL60

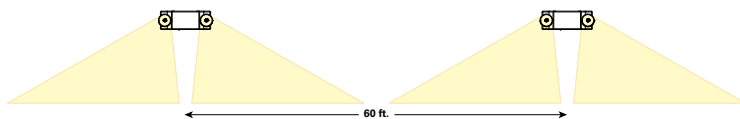
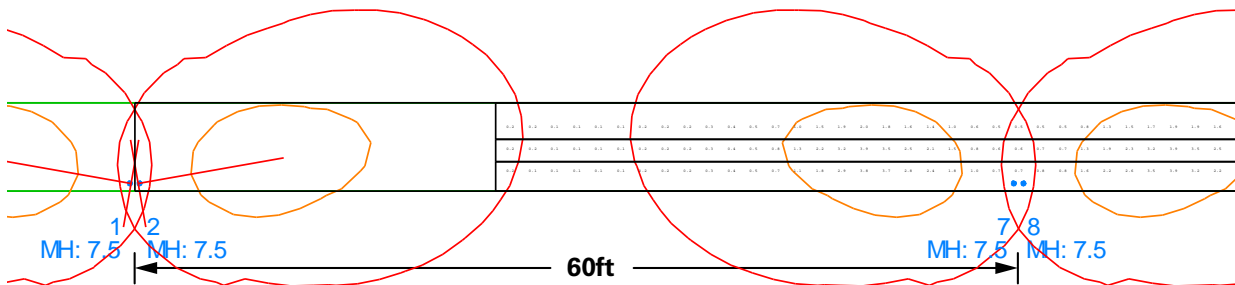

X	Y	Z	Orient	Tilt
-0.25	0.5	7.5	170	57
0.25	0.5	7.5	10	57
120.25	0.5	7.5	10	57
119.75	0.5	7.5	170	57
59.75	0.5	7.5	170	57
60.25	0.5	7.5	10	57
180.25	0.5	7.5	10	57
179.75	0.5	7.5	170	57

***The "Rule of Thumb" spacing guidelines are designed to achieve 1 foot-candle average and 0.1 foot-candle minimum with a 40:1 maximum/minimum ratio. The corridor used is 100 feet long, 9 foot ceiling with a 6 foot wide walkway and 3 foot path of egress. The reflectances are 80% ceiling, 50% walls and 20% floors. The fixture mounting height is 7.5 feet. Cooper Lighting Solutions assumes no responsibility for local requirements or specific project variables. This is a guideline to be used as a design aid, not as guarantee of any code compliance.

**Job Name:**

New Training Facility - St. Tammany Fire Protection District No. 1
 Architect: DAMMON ENGINEERS INC (Slidell)
 Engineer: DAMMON ENGINEERS INC (Slidell)

Catalog Number:

SEL50

Notes:

Type:

EM

WK25-44042

Sure-Lites**SEL25/SEL50/SEL60****Technical Data****Mechanical Housing**

All components are injection molded with a color stable, high impact thermoplastic resin. The surface is textured to improve aesthetic appearance. The housing construction is designed with snap-fit components and reinforcement ribs to provide maximum strength at minimum installation effort. The mounting hole pattern is universal to junction box requirements and is suitable for both wall and ceiling mount applications.

EZ Key – External Power Disconnect

Prevents the battery from cycling during the construction phase and ensures battery is not drained from power cycling.

EZ Hang – Mounting Feature

The hands-free EZ Hang feature allows the installer to hang the emergency light face from the back plate in order to easily and efficiently make the power connections.

Self Diagnostics

The self-diagnostic software will automatically perform all tests required by UL924, and NFPA101 and will systematically calibrate itself in the field; thus reducing installation labor and eliminating manual calibration errors. The system indicates the status of the emergency light at all times using the LED indicator. A 90 minute battery power (emergency mode) simulation test will occur once every 12 months. A 30 second battery power simulation test will occur every 30 days. The Solid-State microprocessor based system has the ability to accurately detect and warn of system failures, plus it incorporates all of the standard electronic features that sets Sure-Lites apart from its competition.

Low Voltage Disconnect

The low-voltage circuitry disconnects the lighting load to protect the battery after run times in excess of the 90 minute UL limit. The disconnect remains in effect until normal utility power is restored preventing deep battery discharge.

Brownout Circuit

The brownout circuit on the SEL emergency light monitors the flow of AC current to the unit and activates the emergency light heads when a predetermined reduction of AC power occurs.

Warranty

SEL units are backed by a five-year warranty on the fixtures.



EZ Key



EZ Hang

Self Diagnostic Testing Operations

The Sure-Lites Eagle Eye Self Diagnostics is continuously monitoring your emergency fixture, and will signal any failure through the 3 color indicator LED.

Initial Operation:

When the unit is first powered up, it will go into a 24 hour fast charge, indicated by the indicator LED pulsing green. Once the unit has fully charged, it will perform a self calibration, after which the LED will change to steady green, indicating the unit is fully charged and float charging the battery to maintain readiness.

Automatic Testing:

The unit will perform a battery capacity, lamp/LED, and charge circuit test every 30 days for 30 seconds. During this time, the indicator LED will change to a steady yellow. It will perform a full battery capacity (90 minute) test once per year. During this time, the indicator LED will change to a blinking yellow.

Manual Testing:

- 10 Second "Installation" test – Press and release the test button once during fast charge (blinking green) to initiate a 10 second quick test. The sign will switch to emergency mode for 10 seconds allowing the installer to verify proper installation of the unit, and the LED indicator will turn solid yellow.
- 30 Second Test – Press and release the test button once during float charge (steady green). The indicator LED will turn steady yellow to indicate the unit is performing a 30 second test of the batteries and lamps/LEDs.
- 90 Minute Test – Press and release the test button a second time during a 30 second test (steady yellow) to change to a 90 minute test. During this test, the LED indicator will change to blinking yellow, and the circuit will perform a full battery capacity, charge circuit, and LED test.
- Canceling Test – Press and release the test button during the 90 minute test (flashing yellow) to return the fixture to its original state (fast charge or float charge)

Laser Test:

The SEL SD products are equipped with a Laser Test function, that allows the unit to be manually tested without the need to physically press the test button. Shining a laser pointer in the hole marked "LASER TEST" on the bottom of the unit has the same effect as a press and release of the test button.

Clearing Failure Codes:

- A battery failure (LED two blink red) can be cleared by replacing the battery. Disconnecting the battery and AC power, or performing a full 90 minute discharge, will reset the error code, however, it will return if the battery is faulty
- Charge Circuit (LED three blink red) and lamp/LED failure (LED four blink red) will clear when the unit successfully passes a manual or automatic 30 second test.

Indicators:

- LED Off – No power to unit, emergency mode.
- LED Steady Green – Unit is fully charged and is float charging the battery to maintain readiness.
- LED Green Pulse – Unit is in a 24 hour fast charge of the battery.
- LED Two Blink Red – Battery has failed a capacity test, or the battery is disconnected. See "Clearing Failure Codes" above.
- LED Three Blink Red – Battery charge circuit has failed. See "Clearing Failure Codes" above.
- LED Four Blink Red – Lamps have burned out, or on an EXIT/Combo, 50% or more of the LEDs have failed. See "Clearing Failure Codes" above.
- LED Steady Yellow – 30 second test or 10 second quick test (Fast Charge only).
- LED Blinking Yellow – 90 minute test.

Maintenance

None required. Replace the batteries as needed according to ambient conditions. However, we recommend that the equipment be tested regularly in accordance with local codes.

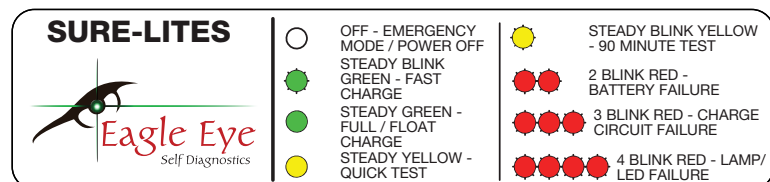



Job Name:

New Training Facility - St. Tammany Fire Protection District No. 1
 Architect: DAMMON ENGINEERS INC (Slidell)
 Engineer: DAMMON ENGINEERS INC (Slidell)

Catalog Number:
 MUR-SA-WHT-CL

Notes:

Type:

S1E

WK25-44042

MURO



TITLE
24



Job/Location: _____
 Contractor: _____ Job Type: _____
 Prepared By: _____ Date: _____



■ **about**

The **MURO** (MUR) is a UL924 Listed, low-profile, zero-uptight architectural LED wallpack with integral emergency battery backup for egress applications. The MURO is cold weather-rated and its fully gasketed die-cast enclosure is IP65 rated for wet conditions. The MURO is available in 4000K CCT and delivers 1500 lm in AC mode and 600 lm in emergency mode. The fixture is available with an optional energy-saving efficient, passive infrared (PIR) sensor.

■ **internal**

The **MURO** Series LED wallpack features a standard integral photocontrol for use in dusk to dawn applications. The photocontrol can be disabled for use in always on or manually switchable applications. The fixture uses a rechargeable, maintenance-free nickel cadmium battery with 120-277V input. The MURO operates at temperatures from -25°C to 50°C (-13°F to 122°F).

■ **external**

The **MURO's** die-cast aluminum housing snap-fits to a mounting plate for easy access and installation. A universal knockout pattern on back for mounting to 3" or 4" J-box, and a 1/2" threaded conduit entry is on top. The LED array is protected by a high-impact, UV-resistant polycarbonate lens that delivers 1500 lm in a Type I distribution.

■ **dimensions**

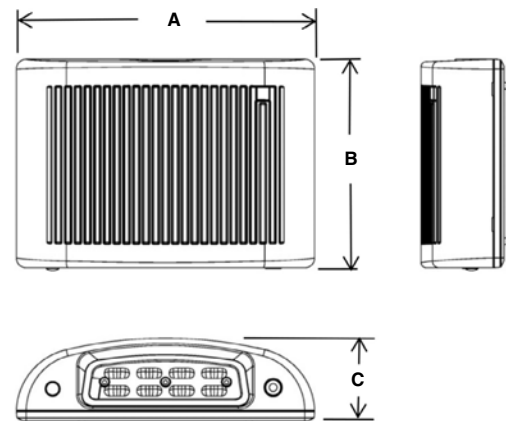

Series	A	B	C
MUR	9.1" 231 mm	6.3" 160 mm	2.6" 66 mm

Weight: 4.5 lb

■ **ordering logic**

EXAMPLE: **MUR-SA-WHT-CL**

Series	Operation	Color Temperature ¹	Finish	Std Feature	Options
MUR	SA (AC + EM)	blank (4000K)	BLK (black) DB (bronze) WHT (white)	CL (cold location)	PIR (passive infrared motion sensor)

NOTE 1: Consult factory for additional CCTs, lead time and MOQs may apply



Job Name:

New Training Facility - St. Tammany Fire Protection District No. 1
 Architect: DAMMON ENGINEERS INC (Slidell)
 Engineer: DAMMON ENGINEERS INC (Slidell)

Catalog Number:
 MUR-SA-WHT-CL

Notes:

Type:

S1E

WK25-44042

Technical

■ **electrical**

BATTERY: The MURO uses long-life, maintenance-free, rechargeable high temperature, 7.2V, 2.Ah NiCad battery which includes an internal heater suitable for cold locations (heater draws an additional 17W for a total of 32W). Maximum recharge time is 24 hours.

■ **integral controls**

Standard Unit: The standard MURO unit includes a photocontrol that will automatically turn on the luminaire when lux ≤ 10 is reached, and automatically turn off luminaire at ≥ 30 lux. The photocontrol may be easily disabled for use with a timer or manual switch.

PIR sensor option: In AC mode, the passive infrared motion sensor will activate the luminaire ONLY when motion is sensed within its detection range during dawn to dusk operation. After two minutes of inactivity, the fixture will shut off. The PIR sensor and photocontrol cannot be disabled.

Mounting Height	PIR Detection Radius
8'	6.6'
10'	8.2'
11.5'	10'

■ **photometrics**

AC Mode

Mounted at 10'

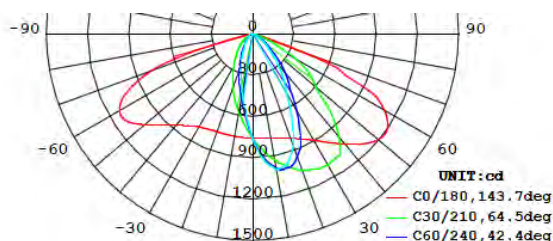
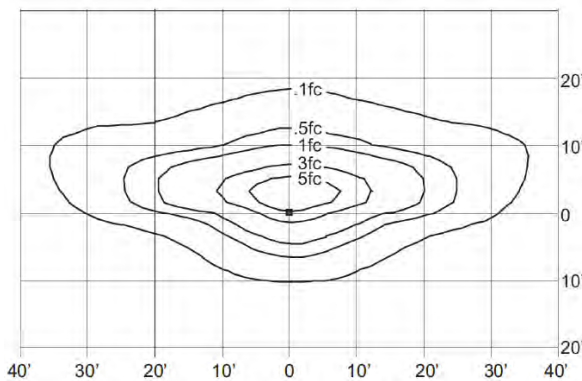

Emergency Mode

Mounting multiple MURO wallpacks at 10' height delivers 60' on-center spacing with a 6' or 3' path of egress.

Mounting Height	On-Center Spacing
7.5'	50'
10'	60'

