

SHOWER RECEPTOR

K-9568

FEATURES

- 60" x 34"
- Acrylic
- Reinforced with fiberglass
- Molded-in floor pattern

CODES/STANDARDS APPLICABLE

Specified model meets or exceeds the following:

- ANSI Z124.2

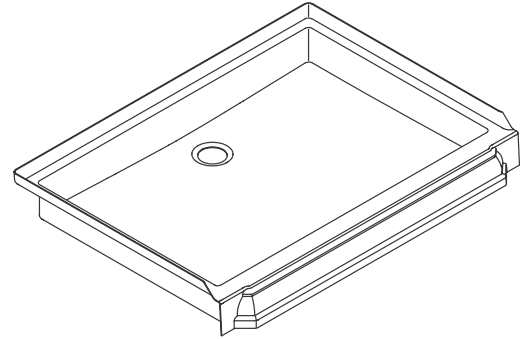

COLORS/FINISHES

- 0 White
- Other Refer to Fixtures Price Book for additional colors

Accessories:

- CP Polished Chrome
- PB Polished Brass
- SH Bright Silver
- BH Bright Brass
- Other Refer to Faucet Price Book for additional colors

SPECIFIED MODEL:

Model	Description	Module Colors/Finishes	
K-9568	Shower receptor	<input type="checkbox"/> 0 White	<input type="checkbox"/> Other_____

Recommended Accessory				
K-9132	Drain	<input type="checkbox"/> CP	<input type="checkbox"/> PB	<input type="checkbox"/> Other_____

Optional Accessories				
K-703026	Forum™ shower enclosure*	<input type="checkbox"/> SH	<input type="checkbox"/> BH	<input type="checkbox"/> 0-White
K-701120	Focal shower enclosure*	<input type="checkbox"/> SH	<input type="checkbox"/> BH	<input type="checkbox"/> 0-White
K-704016	Helios™ shower enclosure*	<input type="checkbox"/> SH	<input type="checkbox"/> BH	<input type="checkbox"/> 0-White

* Refer to Fixtures Price Book for glass options.

PRODUCT SPECIFICATION:

The shower receptor shall be 60" in length and 34" in width. Shower receptor shall be made of acrylic reinforced with fiberglass. Shower receptor shall have molded-in floor pattern. Shower receptor shall be Kohler Model K-9568-_____.

MEMOIRS™

PRODUCT INFORMATION

Fixture:	
Weight	68 lbs.
Configuration	1-piece
Drain Outlet	3-3/8" D.

INSTALLATION NOTES

IMPORTANT: When installing this unit with Kohler Portico™ shower doors, the receptor will need to be recessed a minimum of 1/2" in from the water-resistant wall material to ensure proper door placement.

Roughing-In Notes

Stud opening tolerance (+1/4" -0"). When fire rated wall is specified, dimensions are to the inside of the wall board. Some shimming between stud frame and fixture may be required.

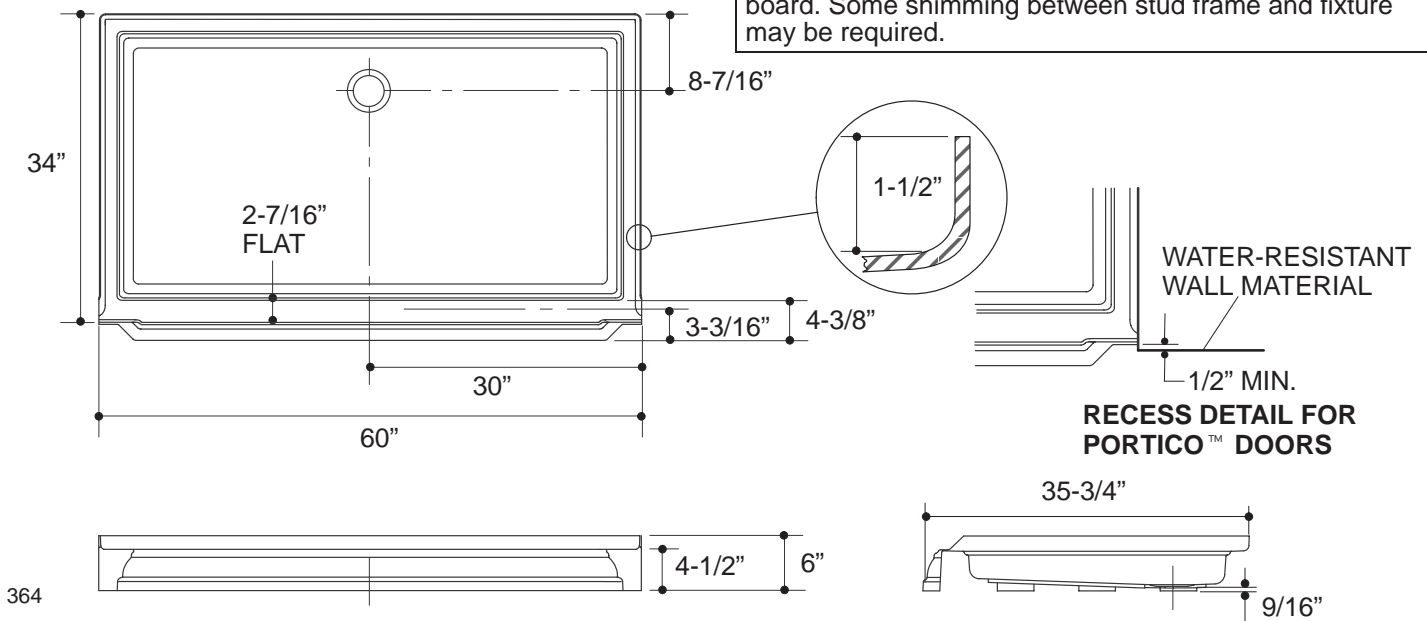

PRODUCT DIAGRAM