

TILE-IN ENTERTAINMENT SINK

K-6589

FEATURES

- 15" x 15"
- Cast iron
- Acid resistant enamel finish
- Tile-in
- Single compartment
- Single-hole (K-6589-1), 2-hole (K-6589-2) or 3-hole (K-6589-3) faucet drilling

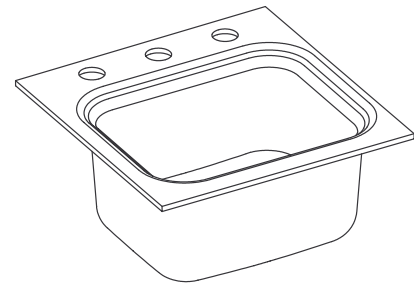

CODES/STANDARDS APPLICABLE

Specified model meets or exceeds the following:

- ASME/ANSI A112.19.1M
- IAPMO/UPC
- CSA International B45

COLORS/FINISHES

- 0 White
- Other Refer to Fixtures Price Book for additional colors

Accessories:

- CP Polished Chrome
- NA None Applicable
- Other Refer to Price Book for additional colors

SPECIFIED MODEL:

Model	Description	Colors/Finishes	
K-6589-1	Single-hole sink	<input type="checkbox"/> 0 White	<input type="checkbox"/> Other_____
K-6589-2	2-hole sink	<input type="checkbox"/> 0 White	<input type="checkbox"/> Other_____
K-6589-3	3-hole sink	<input type="checkbox"/> 0 White	<input type="checkbox"/> Other_____
Optional Accessories			
K-6590	Hardwood cutting board	<input type="checkbox"/> NA	
K-8801	Duostrainer sink strainer	<input type="checkbox"/> CP	<input type="checkbox"/> Other_____

PRODUCT SPECIFICATION:

The tile-in sink shall be 15" in length, and 15" in width. Sink shall be made of cast iron with acid resistant enamel finish. Sink shall be single compartment. Sink shall be single-hole (K-6589-1), 2-hole (K-6589-2) or 3-hole (K-6589-3) faucet drilling. Sink shall be Kohler Model K-6589-_____-_____.

NORTHLAND™

PRODUCT INFORMATION

Fixture*:		basin area	water depth
Sink		9-1/4" x 12"	7"
Outlet	3-7/8" D.		
Faucet holes	1-3/8" D.		

* Approximate measurements for comparison only.

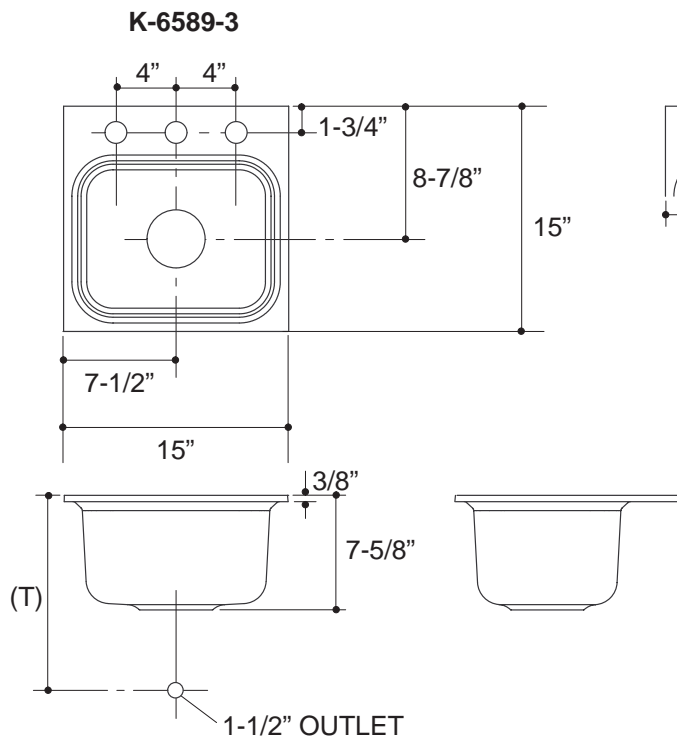

Roughing-In Notes	
(T) Drain typically 13".	
Cutout	14-1/4" x 11-1/2" with 1" radius corners.

1.25>116

PRODUCT DIAGRAM