

Ordering Information

Applicable faucet:	
Lever handles	K-6240-4
ADA Lever handles are ADA compliant	

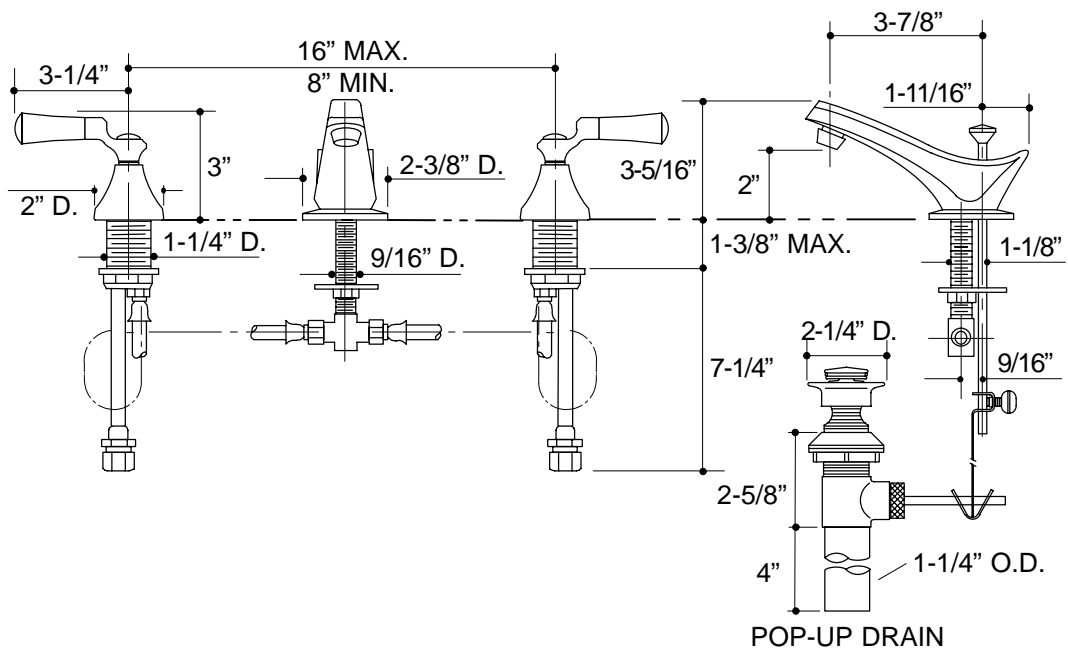

316

K-6240-4 Flair™ Lavatory Faucet
110727-1-AA (9619)

NOTES: