

SHOWER MODULE

K-12467, K-12467-SS K-12468, K-12468-SS

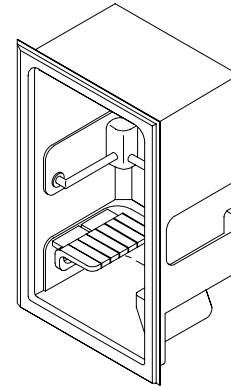

FEATURES

- 52" x 36-3/4" x 83-3/8"
- Acrylic
- Integral soap ledges
- Fold-up seat on left or right
- Nylon grab bars
- Stainless steel grab bars (-SS)
- White or Almond only (K-12467-SS & K-12468-SS)
- Slip-resistant floor

CODES/STANDARDS APPLICABLE

Specified model meets or exceeds the following:

- ANSI Z124.2
- IAPMO/UPC

COLORS/FINISHES

- 0 White
- Other Refer to Fixtures Price Book for additional colors

Accessories:

- CP Polished Chrome
- PB Polished Brass
- SV Nevada Silver™
- BR New England Brass™
- SH Bright Silver
- BH Bright Brass
- Other Refer to Faucets Price Book for additional finishes
- NA None Applicable

SPECIFIED MODEL:

Model	Description	Colors/Finishes	
K-12467	Shower module with fold-up seat at left	<input type="checkbox"/> 0 White	<input type="checkbox"/> Other_____
K-12467-SS	Shower module with fold-up seat at left (stainless steel grab bars)	<input type="checkbox"/> 0 White	<input type="checkbox"/> Other_____
K-12468	Shower module with fold-up seat at right	<input type="checkbox"/> 0 White	<input type="checkbox"/> Other_____
K-12468-SS	Shower module with fold-up seat at right (stainless steel grab bars)	<input type="checkbox"/> 0 White	<input type="checkbox"/> Other_____

Recommended Accessories

K-9132	Drain	<input type="checkbox"/> CP	<input type="checkbox"/> PB	<input type="checkbox"/> Other_____
--------	-------	-----------------------------	-----------------------------	-------------------------------------

Optional Accessories on Page 2

PRODUCT SPECIFICATION:

The shower module shall be 52" in length, 36-3/4" in width, and 83-3/8" in height. Shower module shall be made of acrylic. Shower module shall have integral soap ledges. Shower module shall have fold-up seat on left or right. Shower module shall have nylon grab bars. Shower module shall have stainless steel grab bars (-SS). Shower module shall have a slip-resistant floor. Shower module shall be Kohler Model K-_____-_____-_____.

Optional Accessories				
K-1570	Dome light			<input type="checkbox"/> NA
K-9873	Glassworks™ bypass shower door* OR	<input type="checkbox"/> SV	<input type="checkbox"/> BR	
K-9892	Glassworks™ bypass shower door* OR	<input type="checkbox"/> SV	<input type="checkbox"/> BR	
K-703030	Forum™ bypass shower door*	<input type="checkbox"/> SH	<input type="checkbox"/> BH	<input type="checkbox"/> 0 White

* Refer to Fixtures Price Book for glass options.

PRODUCT INFORMATION

Fixture:	
Weight	220 lbs.
Configuration	1-piece
Drain Outlet	3-1/4" D.

INSTALLATION NOTES

Fixture not drilled for supply fittings.

Shimming may be required to level fixture.

For optimum accessibility, specify faucets and fittings to install and operate within the control area shown.

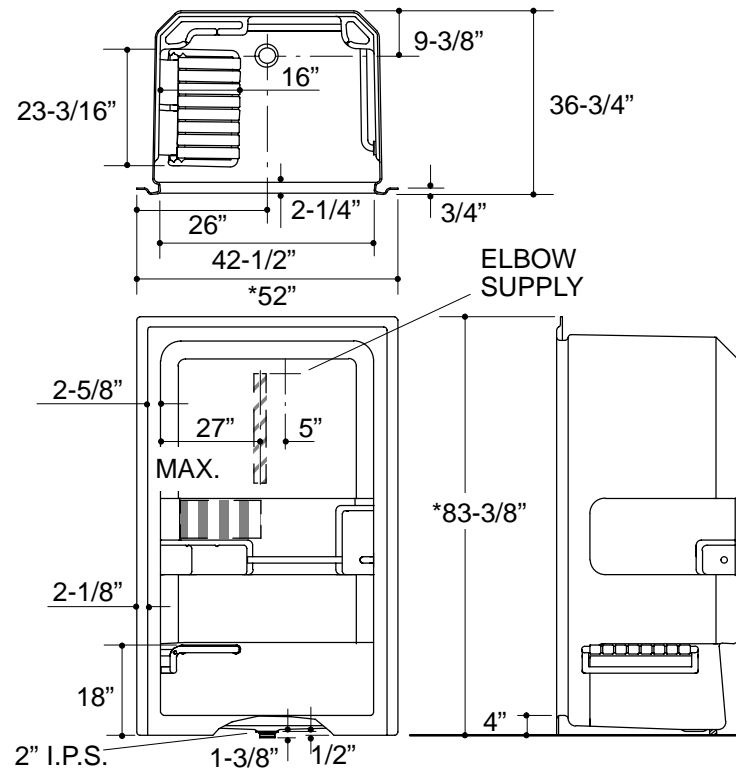



Roughing-In Notes

*Recess opening must be 52" x 83-3/8"

Stud opening tolerance (+ 1/4" - 0"). When fire rated wall is specified, dimensions are to the inside of the wall board. Some shimming between stud frame and fixture may be required.

Provide clear floor space per ANSI A117.1, and as shown.

 Represents control area for faucets.

 Represents 24" wall mount slide bar.

 Represents clear floor space for 36" x 57" side entrance.

 Represents clear floor space for 36" x 57" side entrance.

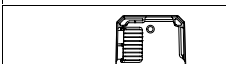
 Represents clear floor space for 48" x 57" front entrance.

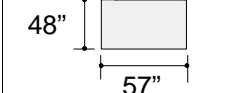
 Represents clear floor space for 48" x 57" front entrance.

.85<132

PRODUCT DIAGRAM