

**BATH AND SHOWER FAUCET TRIM
K-T6900**

**ALSO K-T6902, K-T6904, K-304,
K-306-KS**

FEATURES

- Brass construction
- Available with square or lever handle
- Intended for use with Rite-Temp or Hi Flow Rite-Temp valves

CODES/STANDARDS APPLICABLE

Specified model meets or exceeds the following:

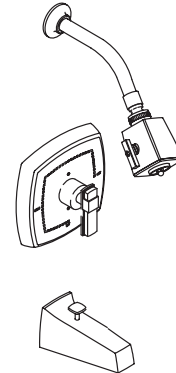

- ASME/ANSI A112.18.1M
- ASSE/ANSI 1016
- CSA B125 (K-T6900, K-T6902)
- IAPMO/UPC (K-T6900, K-T6902)



COLORS/FINISHES

- CP Polished Chrome
- PB Polished Brass
- Other Refer to Faucets Price Book for additional finishes

SPECIFIED MODEL: For complete faucet, both faucet trim and Rite-Temp valve must be specified.







Model	Description				 ADA		
		<input type="checkbox"/> CP	<input type="checkbox"/> PB	<input type="checkbox"/> Other_____	<input type="checkbox"/> CP	<input type="checkbox"/> PB	<input type="checkbox"/> Other_____
K-T6900-2	Bath and Shower Trim, Square Handle	<input type="checkbox"/> CP	<input type="checkbox"/> PB	<input type="checkbox"/> Other_____			
K-T6900-4	Bath and Shower Trim, Lever Handle				<input type="checkbox"/> CP	<input type="checkbox"/> PB	<input type="checkbox"/> Other_____
K-T6902-2	Shower Only Trim, Square Handle	<input type="checkbox"/> CP	<input type="checkbox"/> PB	<input type="checkbox"/> Other_____			
K-T6902-4	Shower Only Trim, Lever Handle				<input type="checkbox"/> CP	<input type="checkbox"/> PB	<input type="checkbox"/> Other_____
K-T6904-2	Valve Only Trim, Square Handle	<input type="checkbox"/> CP	<input type="checkbox"/> PB	<input type="checkbox"/> Other_____			
K-T6904-4	Valve Only Trim, Lever Handle				<input type="checkbox"/> CP	<input type="checkbox"/> PB	<input type="checkbox"/> Other_____

Required Accessory				
K-304-K	Rite-Temp Valve Without Stops	<input type="checkbox"/> NA		
K-304-KS	Rite-Temp Valve With Stops		<input type="checkbox"/> NA	
K-306-KS	Hi Flow Rite-Temp Valve With Integral Stops			<input type="checkbox"/> NA

Optional Accessories on Page 2.

PRODUCT SPECIFICATION:

Rite-Temp pressure-balancing single-control bath and shower faucet trim shall be of brass construction. Bath and shower trim shall include showerhead with arm and flange, faceplate with handle, and 4-7/8" diverter spout with N.P.T. connection. Shower only trim shall include showerhead with arm and flange, and faceplate with handle. Valve only trim shall include faceplate with handle. Faucet trim shall be K-T_____ - _____ - _____ and Rite-Temp valve shall be K-304-_____ -NA OR K-306-KS-NA Hi Flow Rite-Temp valve.

Optional Accessories					
K-9917		Large Handle Stone Inset, Single			<input type="checkbox"/> Other_____
K-9923		Large Handle Metal Inset, Single	<input type="checkbox"/> CP	<input type="checkbox"/> PB	<input type="checkbox"/> Other_____
K-9926		Large Handle Ceramic Inset, Single			<input type="checkbox"/> Other_____
K-9932		Large Handle Champeve Inset, Single			<input type="checkbox"/> Other_____
K-9971		Small Lever Metal Inset, Single	<input type="checkbox"/> CP	<input type="checkbox"/> PB	<input type="checkbox"/> Other_____
K-9985		Small Lever Stone Inset, Single			<input type="checkbox"/> Other_____
88526		Hi Flow Rite-Temp Thin Wall Installation Kit	<input type="checkbox"/> CP	<input type="checkbox"/> PB	<input type="checkbox"/> Other_____

PRODUCT INFORMATION



WARNING: Risk of damage to the K-306-KS valve assembly. When using the K-306-KS valve in a fiberglass or acrylic installation, use the thin wall installation kit (88526).

INSTALLATION NOTES

Avoid cross-flow conditions. Do not install shut-off device on either valve outlet.

Cap shower outlet if deck-mount spout, diverter, or handshower is connected to spout outlet.

Install straight pipe or tube drop of 7 to 18" with single elbow between valve and wall-mount spout.

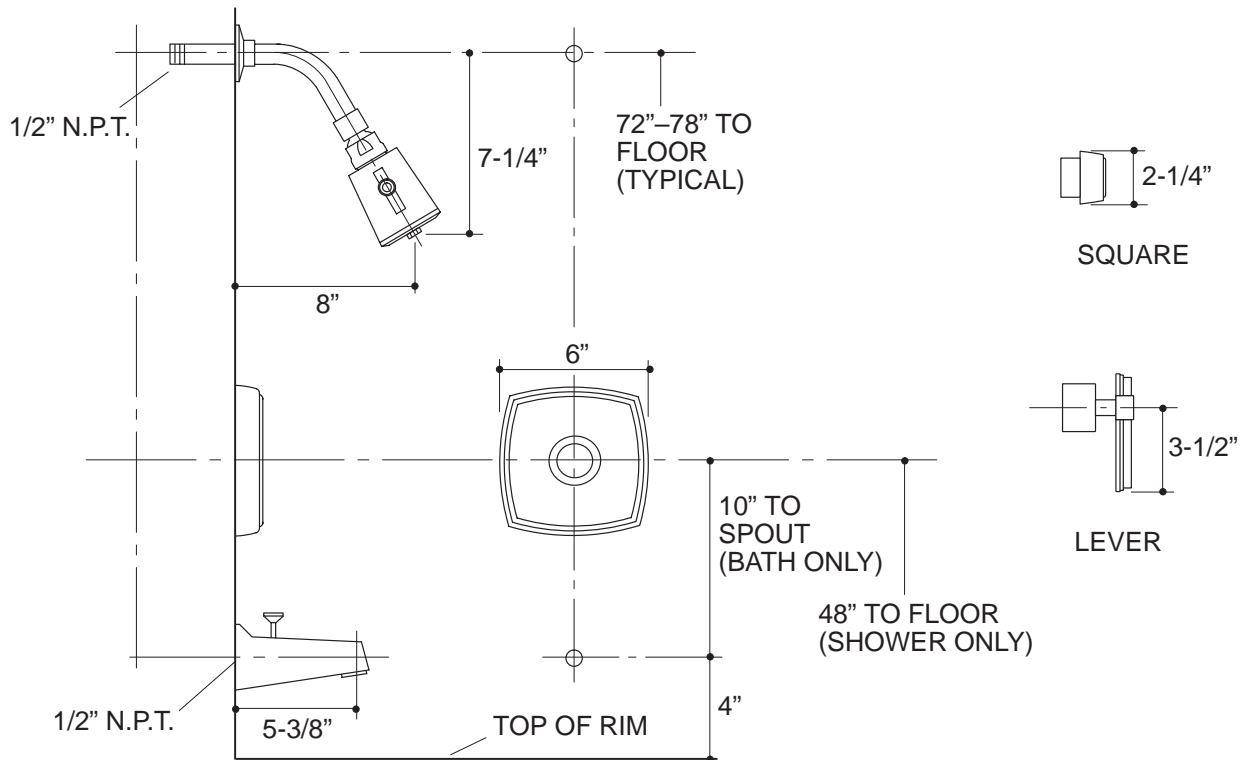

18

PRODUCT DIAGRAM