

**SHOWER FAUCET  
K-7905**

**FEATURES**

- Brass construction
- Brass valve bodies
- 1/2" quarter-turn washerless ceramic disc valves
- Available with lever or ball handles

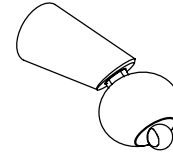

**CODES/STANDARDS APPLICABLE**

Specified model meets or exceeds the following:

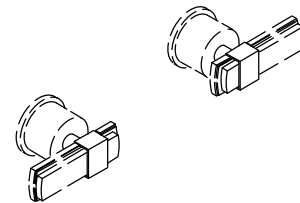

- ASME/ANSI A112.18.1M
- CSA B125
- IAPMO/UPC







**COLORS/FINISHES**

- CP Polished Chrome
- PB Polished Brass
- Other Refer to Faucets Price Book for additional finishes

**SPECIFIED MODEL:**

Model	Description	 	
K-7905-4	With Lever Handles	<input type="checkbox"/> CP <input type="checkbox"/> PB	
K-7905-8	With Ball Handles		<input type="checkbox"/> CP <input type="checkbox"/> PB

Optional Accessories	 	 
K-9970 Large Lever Handle Metal Insets, Pair	<input type="checkbox"/> CP <input type="checkbox"/> PB <input type="checkbox"/> Other_____	
K-9984 Large Lever Handle Stone Insets, Pair		<input type="checkbox"/> Other_____

**PRODUCT SPECIFICATION:**

Two-handle shower faucet shall be of brass construction. Faucet shall feature brass valve bodies. Faucet shall feature 1/2" quarter-turn washerless ceramic disc valves, assuring positive handle stop positioning. Product shall include showerhead with arm, and lever or ball handles. Faucet shall be Kohler Model K-7905-\_\_\_\_\_-\_\_\_\_\_.

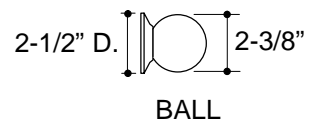
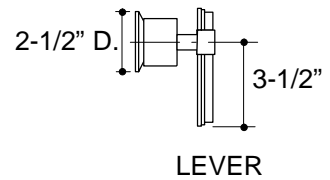
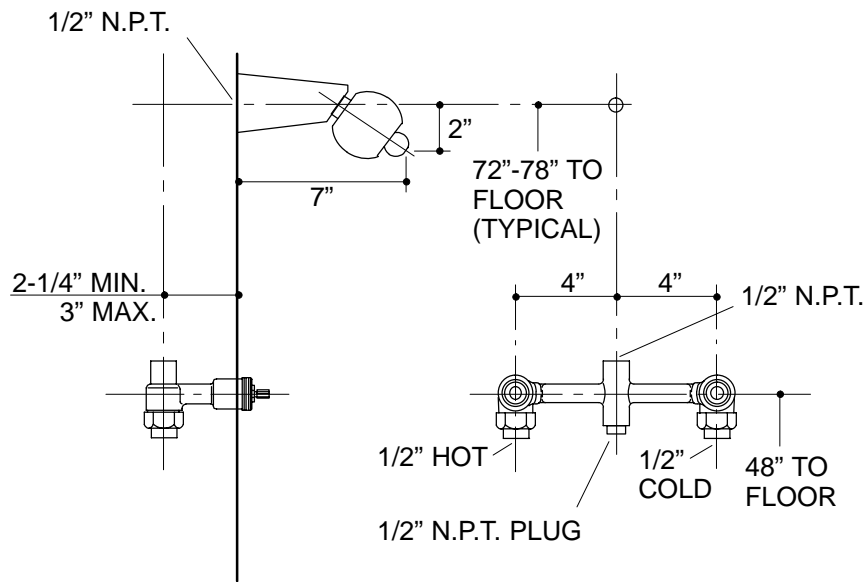

## PRODUCT DIAGRAM