

**IV GEORGES BRASS™**

**BATH AND SHOWER FAUCET TRIM  
K-T6808**

**ALSO K-T6809, K-T6810, K-304**

**FEATURES**

- Brass construction
- Available with lever or cross handle

**CODES/STANDARDS APPLICABLE**

Specified model meets or exceeds the following:

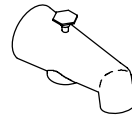
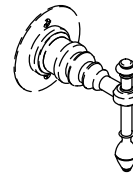
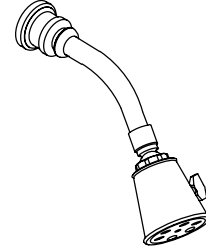

- ASME/ANSI A112.18.1M
- ASSE/ANSI 1016
- CSA B125
- IAPMO/UPC



**COLORS/FINISHES**

- PB Polished Brass
- Other Refer to Faucets Price Book for additional finishes

**SPECIFIED MODEL:** For complete faucet, both faucet trim and Rite-Temp valve must be specified.



| Model      | Description                        |  <span style="border: 1px solid black; padding: 2px;">ADA</span> |                                     |  <span style="border: 1px solid black; padding: 2px;">ADA</span> |                                     |
|------------|------------------------------------|---|-------------------------------------|---|-------------------------------------|
|            |                                    | <input type="checkbox"/> PB   | <input type="checkbox"/> Other_____ | <input type="checkbox"/> PB   | <input type="checkbox"/> Other_____ |
| K-T6808-3D | Bath and Shower Trim, Cross Handle | <input type="checkbox"/> PB   | <input type="checkbox"/> Other_____ |   |                                     |
| K-T6808-4D | Bath and Shower Trim, Lever Handle |   |                                     | <input type="checkbox"/> PB   | <input type="checkbox"/> Other_____ |
| K-T6809-3D | Shower Only Trim, Cross Handle     | <input type="checkbox"/> PB   | <input type="checkbox"/> Other_____ |   |                                     |
| K-T6809-4D | Shower Only Trim, Lever Handle     |   |                                     | <input type="checkbox"/> PB   | <input type="checkbox"/> Other_____ |
| K-T6810-3D | Valve Only Trim, Cross Handle      | <input type="checkbox"/> PB   | <input type="checkbox"/> Other_____ |   |                                     |
| K-T6810-4D | Valve Only Trim, Lever Handle      |   |                                     | <input type="checkbox"/> PB   | <input type="checkbox"/> Other_____ |



**Required and Optional Accessories on Page 2.**

**PRODUCT SPECIFICATION:**

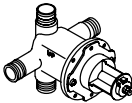
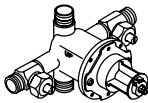
Rite-Temp pressure-balancing single-control bath and shower faucet trim shall be of brass construction. Bath and shower trim shall include showerhead with arm and flange, 4-7/8" diverter spout with N.P.T. connection, and handle. Shower only trim shall include showerhead with arm and flange, and handle. Valve only trim shall include handle. Faucet trim shall be K-T\_\_\_\_\_-\_\_\_\_\_-\_\_\_\_\_- and ceramic dial faceplate shall be Kohler Model K-146-\_\_\_\_\_. Rite-Temp valve shall be K-304-\_\_\_\_\_-NA.

# IV GEORGES BRASS™

| Required Accessories |                               |  |  |  |
|----------------------|-------------------------------|---|---|---|
| K-304-K              | Rite-Temp Valve Without Stops | <input type="checkbox"/> NA   |   |   |
| K-304-KS             | Rite-Temp Valve With Stops    |   | <input type="checkbox"/> NA   |   |
| K-146                | Ceramic Dial Faceplate        |   |   | <input type="checkbox"/> Other_____   |

| Optional Accessories |   |  |  |
|----------------------|---|--|---|
| K-6791               | IV Georges Brass accent kit (For K-6808-3D) | <input type="checkbox"/> PB <input type="checkbox"/> Other_____                    |   |
| K-6798               | IV Georges Brass accent kit (For K-6808-4D) |  | <input type="checkbox"/> PB <input type="checkbox"/> Other_____                     |

## INSTALLATION NOTES

Avoid cross-flow conditions. Do not install shut-off device on either valve outlet.

Cap shower outlet if deck-mount spout, diverter, or handshower is connected to spout outlet.

Install straight pipe or tube drop of 7 to 18" with single elbow between valve and wall-mount spout.

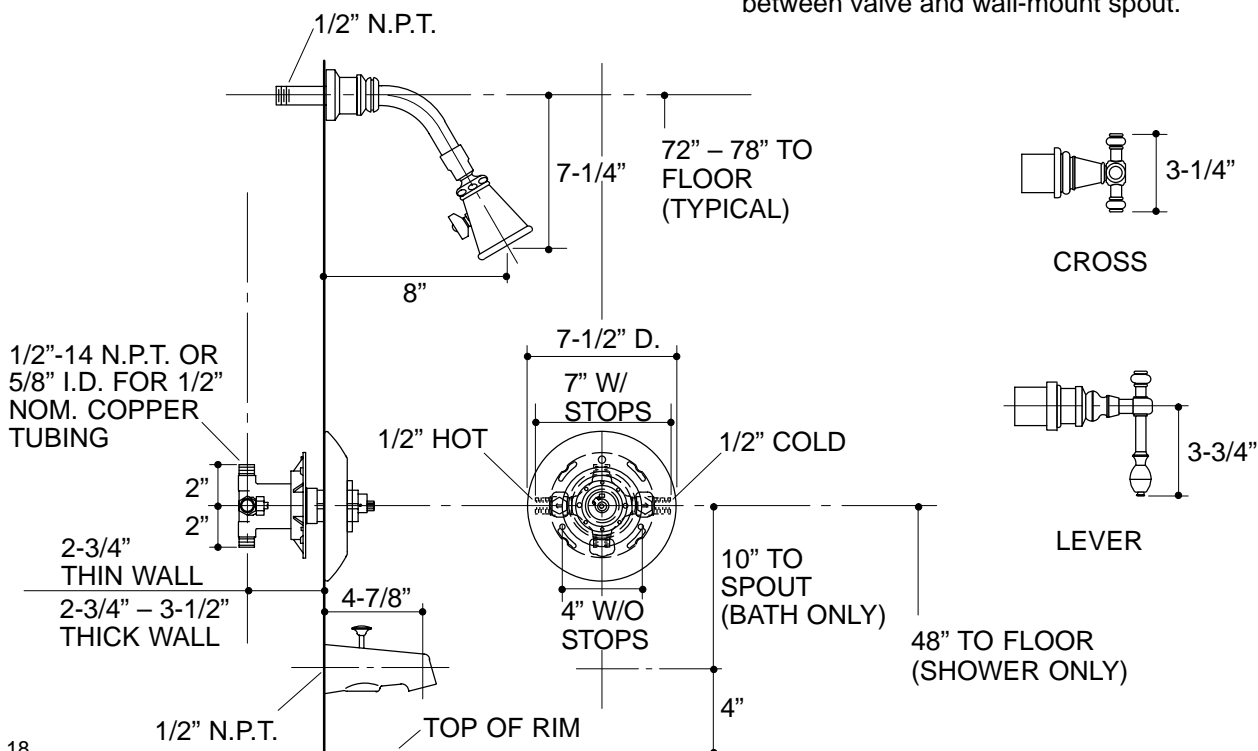

## PRODUCT DIAGRAM