

IV GEORGES BRASS™

**BATH AND SHOWER FAUCET TRIM
K-T6808**

**ALSO K-T6809, K-T6810, K-304,
K-306-KS**

FEATURES

- Brass construction
- Available with lever or cross handle
- Intended for use with Rite-Temp or Hi Flow Rite-Temp valves

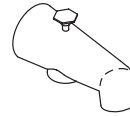
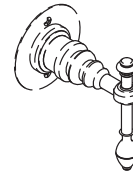
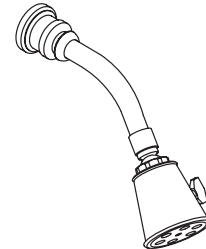

CODES/STANDARDS APPLICABLE





Specified model meets or exceeds the following:

- ASME/ANSI A112.18.1M
- ASSE/ANSI 1016
- CSA B125
- IAPMO/UPC

COLORS/FINISHES

- PB Polished Brass
- Other Refer to Faucets Price Book for additional finishes

SPECIFIED MODEL: For complete faucet, both faucet trim and Rite-Temp valve must be specified.



Model	Description	ADA		ADA	
					
K-T6808-3D	Bath and Shower Trim, Cross Handle	<input type="checkbox"/> PB	<input type="checkbox"/> Other___		
K-T6808-4D	Bath and Shower Trim, Lever Handle			<input type="checkbox"/> PB	<input type="checkbox"/> Other___
K-T6809-3D	Shower Only Trim, Cross Handle	<input type="checkbox"/> PB	<input type="checkbox"/> Other___		
K-T6809-4D	Shower Only Trim, Lever Handle			<input type="checkbox"/> PB	<input type="checkbox"/> Other___
K-T6810-3D	Valve Only Trim, Cross Handle	<input type="checkbox"/> PB	<input type="checkbox"/> Other___		
K-T6810-4D	Valve Only Trim, Lever Handle			<input type="checkbox"/> PB	<input type="checkbox"/> Other___



Required and Optional Accessories on Page 2.

PRODUCT SPECIFICATION:

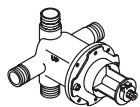
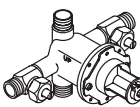
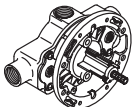
Rite-Temp pressure-balancing single-control bath and shower faucet trim shall be of brass construction. Bath and shower trim shall include showerhead with arm and flange, 4-7/8" diverter spout with N.P.T. connection, and handle. Shower only trim shall include showerhead with arm and flange, and handle. Valve only trim shall include handle. Faucet trim shall be K-T_____-_____-_____ and ceramic dial faceplate shall be Kohler Model K-146-_____. Rite-Temp valve shall be K-304-_____-NA OR K-306-KS-NA Hi Flow Rite-Temp valve.

IV GEORGES BRASS™

Required Accessories					
K-304-K	Rite-Temp Valve Without Stops	<input type="checkbox"/> NA			
K-304-KS	Rite-Temp Valve With Stops		<input type="checkbox"/> NA		
K-306-KS	Hi Flow Rite-Temp Valve With Integral Stops			<input type="checkbox"/> NA	
K-146	Ceramic Dial Faceplate				<input type="checkbox"/> Other___

Optional Accessories						
K-6791	IV Georges Brass accent kit (For K-6808-3D)	<input type="checkbox"/> PB	<input type="checkbox"/> Other___			
K-6798	IV Georges Brass accent kit (For K-6808-4D)			<input type="checkbox"/> PB	<input type="checkbox"/> Other___	
88526	Hi Flow Rite-Temp Thin Wall Installation Kit				<input type="checkbox"/> CP	<input type="checkbox"/> PB <input type="checkbox"/> Other___

PRODUCT INFORMATION



WARNING: Risk of damage to the K-306-KS valve assembly. When using the K-306-KS valve in a fiberglass or acrylic installation, use the thin wall installation kit (88526).

INSTALLATION NOTES

Avoid cross-flow conditions. Do not install shut-off device on either valve outlet.

Cap shower outlet if deck-mount spout, diverter, or handshower is connected to spout outlet.

Install straight pipe or tube drop of 7 to 18" with single elbow between valve and wall-mount spout.

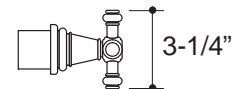
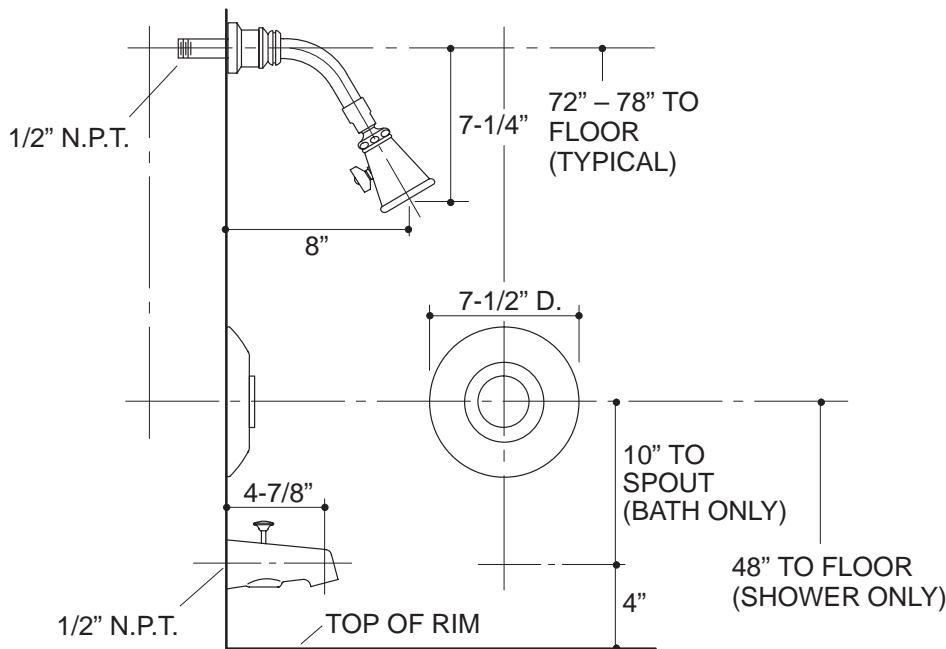

CROSS

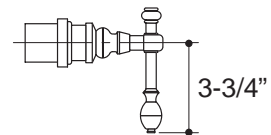

LEVER

18

PRODUCT DIAGRAM