

Ordering Information

Accessories/hardware:		
Profile receptor	K-9861	optional
Captiva™ receptor	K-9534	optional

Product Information

Fixture:	
Weight, shower enclosure	61 Kg.
Glass, tempered safety	clear
Included Components:	
Frames and hardware	K-9556
Shower door	K-9550
Filler panel	K-9552

Installation Notes

Refer to installation instructions included with fixture before beginning installation.

Roughing-In Notes

Tempered glass conforms to ANSI Z97.1.

Structural support required in the ceiling above these locations.

Leave studs exposed. Shower enclosure wall jambs must be installed directly to studs.

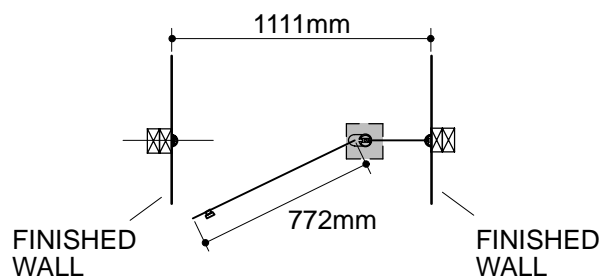

TOP VIEW

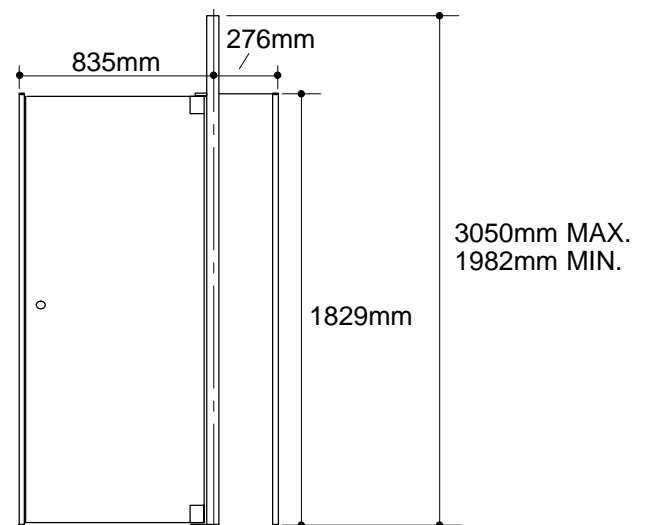

FRONT VIEW