

**FEATURES**

- Brass construction
- Flexible connections
- Brass valve bodies
- Quarter-turn washerless ceramic disc valves
- Pop-up drain with lift rod and tailpiece
- Variety of handle style options
- Below-the-rim swivel spray
- Wall-mount vacuum breaker

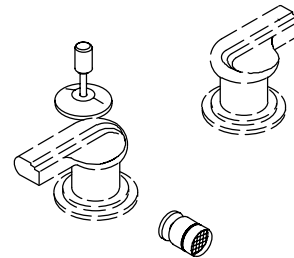

**CODES/STANDARDS APPLICABLE**

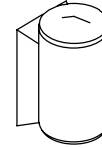

Specified model meets or exceeds the following:

- ASME/ANSI A112.18.1M
- ASSE 1001
- CSA B125
- IAPMO/UPC

**COLORS/FINISHES**

- CP Polished Chrome
- PB Polished Brass

**SPECIFIED MODEL:**

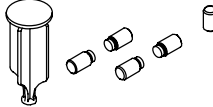
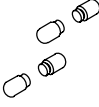
Model	Description			ADA		ADA
K-8244-2	With Square Handles	<input type="checkbox"/> CP <input type="checkbox"/> PB				
K-8244-4A	With Swirl Lever Handles		<input type="checkbox"/> CP <input type="checkbox"/> PB			
K-8244-6	With T-Handles				<input type="checkbox"/> CP <input type="checkbox"/> PB	
<b>Optional Accessories</b>						
K-16200	Accent Kit: Lift Knob, Drain Plug, and Four T-Handle Endpieces	<input type="checkbox"/> CP	<input type="checkbox"/> PB	<input type="checkbox"/> Other_____		
K-16201	Accent Kit: Four T-Handle Endpieces				<input type="checkbox"/> CP	<input type="checkbox"/> PB <input type="checkbox"/> Other_____

**PRODUCT SPECIFICATION:**

Two-handle fixture-mount bidet faucet shall be of brass construction. Faucet shall feature brass valve bodies. Faucet shall feature quarter-turn washerless ceramic disc valves, assuring positive handle stop positioning. Product shall include flexible connections, pop-up drain with lift rod and tailpiece, handles, below-the-rim swivel spray, and wall-mount vacuum breaker. Faucet shall be Kohler Model K-8244-\_\_\_\_\_-\_\_\_\_\_-\_\_\_\_\_.

# TABORET®

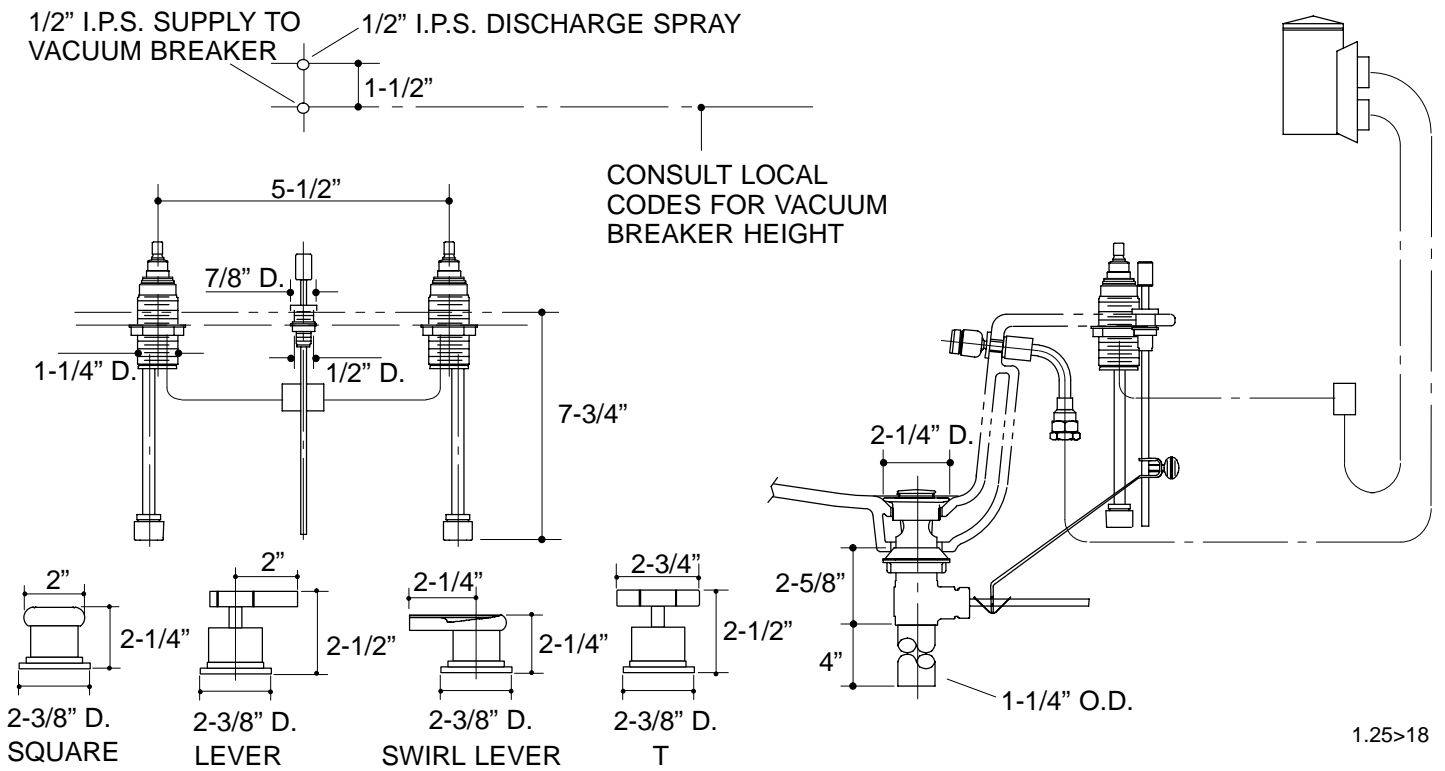

## PRODUCT DIAGRAM