

Ordering Information

Accessories/hardware:		
Drain	K-9132	recommended
Glassworks shower enclosure or Forum bypass shower door	K-9854	recommended
Glassworks steam door	K-703030	
Steam generator	K-9809	optional
Dome Light	K-1559-BA	optional
	K-1570	optional

Product Information

Fixture:	
Weight	94 Kg.
Configuration	3-piece
Drain Outlet	Ø86mm

Installation Notes

Refer to installation instructions included with fixture before beginning installation.

Fixture not drilled for supply fittings.

Shimming may be required to level fixture.

Mastershower K-74 and K-75 not recommended.

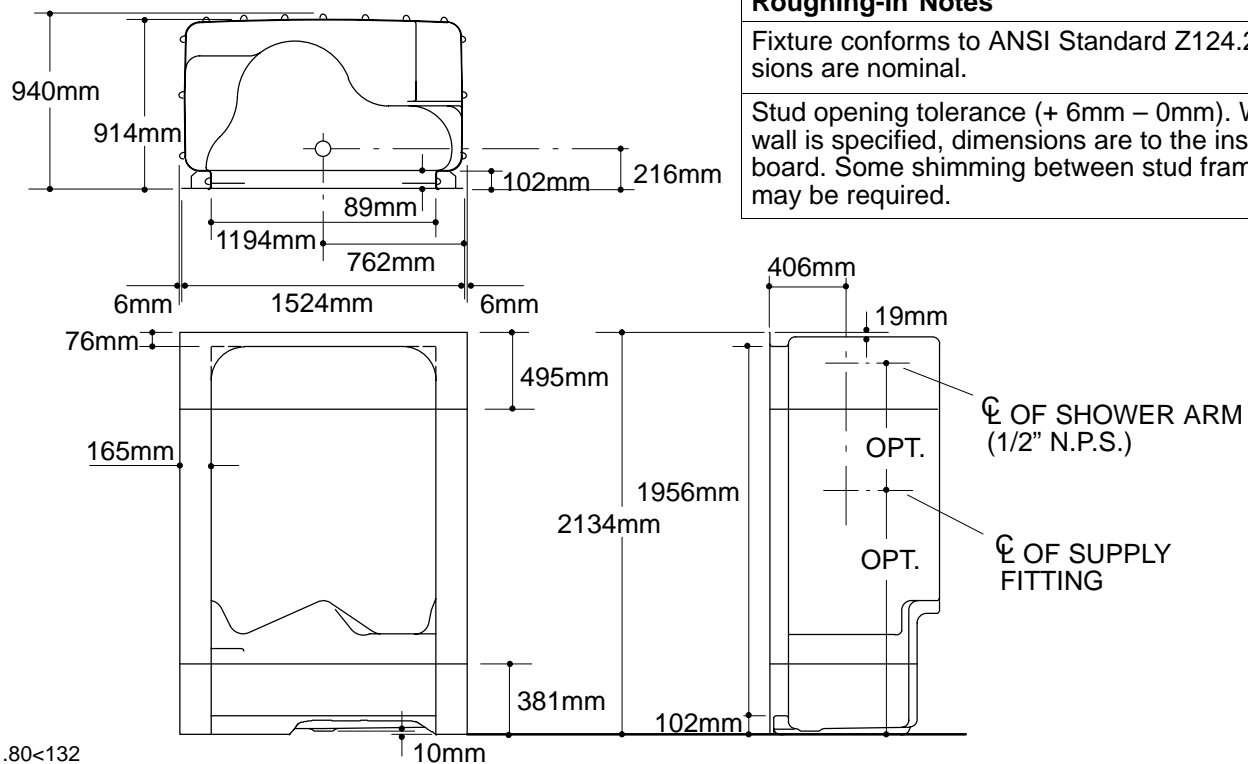

Roughing-In Notes

Fixture conforms to ANSI Standard Z124.2. All dimensions are nominal.

Stud opening tolerance (+ 6mm – 0mm). When fire rated wall is specified, dimensions are to the inside of the wall board. Some shimming between stud frame and fixture may be required.

.80<132