

Ordering Information

Applicable product:		
203mm centers	K-2950-8	shown
Single-hole	K-2950-1	not shown
102mm centers	K-2950-4	not shown
Accessories/hardware:		
Trap	K-8998	recommended

Product Information

ADA compliant.			
Fixture*:		basin area	water depth
Lavatory		432 x 279mm	108mm
Outlet	Ø43mm		
* Approximate measurements for comparison only.			
Holes	K-2950-8	K-2950-1	K-2950-4
Spout	Ø29mm	Ø35mm	Ø29mm
Faucet	Ø33mm		Ø30mm
Included Components:			
Overflow ferrule (1)			84896
Cutout template			113905-7

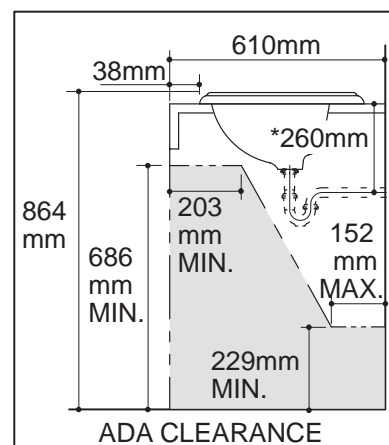
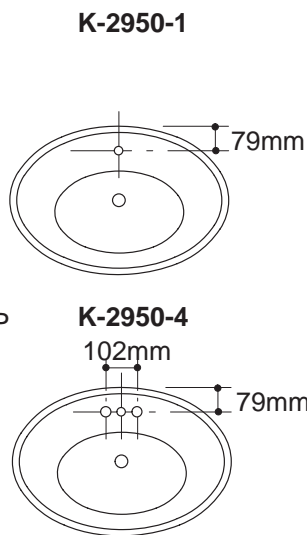
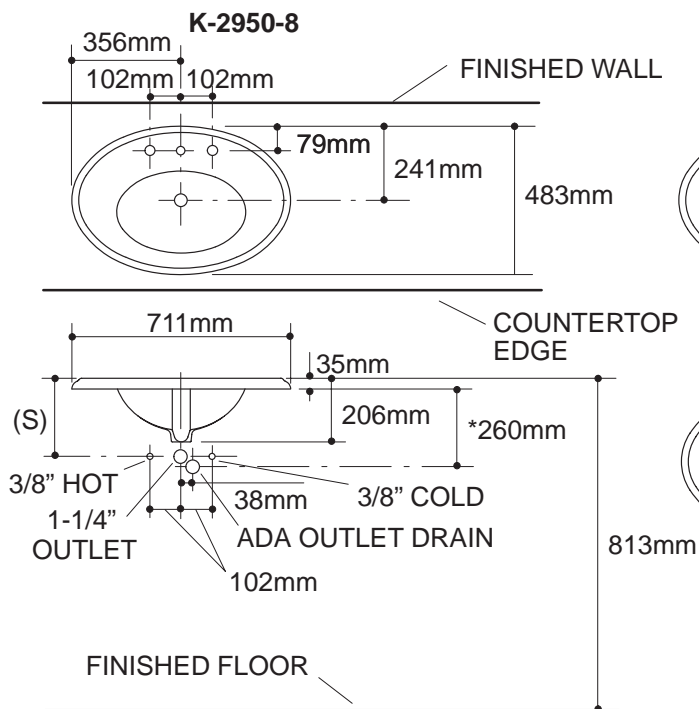

.65<116

Roughing-In Notes

Fixture dimensions are nominal and conform to tolerances in ASME Standard A112.19.1M.

*Based on K-8998, with 25mm tailpiece exposed.

(S) 254mm (Based on 305mm riser which may require cutting).