

FINIAL FUNDAMENTALS

SHOWER FAUCET TRIM

K-T313

ALSO K-T309, K-304, K-306-KS

FEATURES

- Brass construction
- Variety of handle style options
- Intended for use with Rite-Temp or Hi Flow Rite-Temp valves

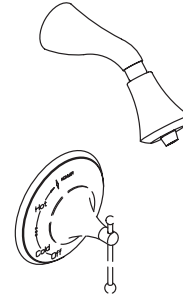

CODES/STANDARDS APPLICABLE



Specified model meets or exceeds the following:

- ASME/ANSI A112.18.1M
- ASSE/ANSI 1016
- CSA B125
- IAPMO/UPC

COLORS/FINISHES

- CP Polished Chrome
- Other Refer to Faucets Price Book for additional finishes

SPECIFIED MODEL: For complete faucet, both faucet trim and Rite-Temp valve must be specified.

Model	Description	 ADA	 ADA	 ADA
K-T313-3	Shower Only Trim With Cross Handle	<input type="checkbox"/> Other _____		
K-T313-4	Shower Only Trim With Lever Handle		<input type="checkbox"/> CP <input type="checkbox"/> Other _____	
K-T313-6	Shower Only Trim With Tee Handle			<input type="checkbox"/> CP <input type="checkbox"/> Other _____
K-T309-3	Valve Only Trim With Cross Handle	<input type="checkbox"/> Other _____		
K-T309-4	Valve Only Trim With Lever Handle		<input type="checkbox"/> CP <input type="checkbox"/> Other _____	
K-T309-6	Valve Only Trim With Tee Handle			<input type="checkbox"/> CP <input type="checkbox"/> Other _____

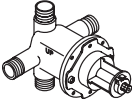
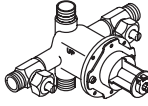
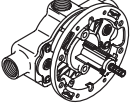
Required Accessory				
K-304-K	Rite-Temp Valve Without Stops	<input type="checkbox"/> NA		
K-304-KS	Rite-Temp Valve With Stops		<input type="checkbox"/> NA	
K-306-KS	Hi Flow Rite-Temp Valve With Integral Stops			<input type="checkbox"/> NA

Optional Accessory				
88526	Hi Flow Rite-Temp Thin Wall Installation Kit	<input type="checkbox"/> CP	<input type="checkbox"/> PB	<input type="checkbox"/> Other _____

PRODUCT SPECIFICATION:

Rite-Temp pressure-balancing single-control shower faucet trim shall be of brass construction. Shower only trim shall include showerhead with arm, and faceplate with handle. Valve only trim shall include faceplate with handle. Faucet trim shall be Kohler Model K-T _____ - _____ - _____ and Rite-Temp valve shall be K-304- _____ -NA OR K-306-KS-NA Hi Flow Rite-Temp valve..

FINIAL FUNDAMENTALS

PRODUCT INFORMATION

WARNING: Risk of damage to the K-306-KS valve assembly. When using the K-306-KS valve in a fiberglass or acrylic installation, use the thin wall installation kit (88526).

INSTALLATION NOTES

Avoid cross-flow conditions. Do not install shut-off device on either valve outlet.

Cap shower outlet if deck-mount spout, diverter, or handshower is connected to spout outlet.

Install straight pipe or tube drop of 7 to 18" with single elbow between valve and wall-mount spout.

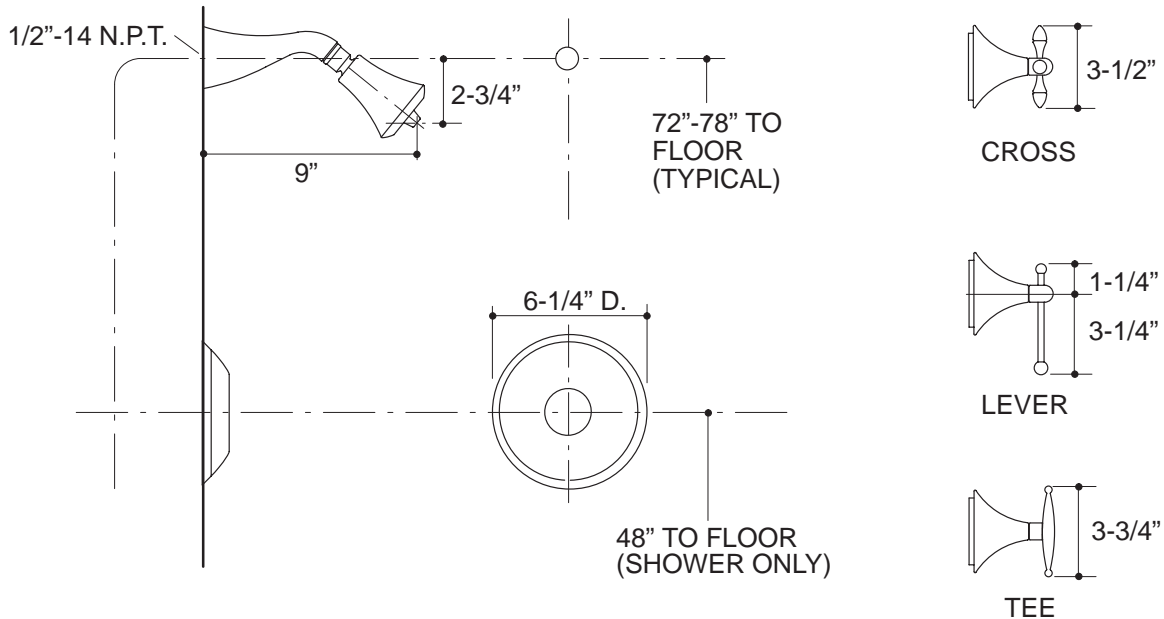

PRODUCT DIAGRAM