

## FEATURES

- 6'
- Cast iron
- Acid resistant enamel finish
- Faucet and soap dish drillings

## CODES/STANDARDS APPLICABLE

Specified model meets or exceeds the following:

- ASME/ANSI A112.19.1M
- IAPMO/UPC
- Canadian Standards Association (CSA)
- State of Massachusetts

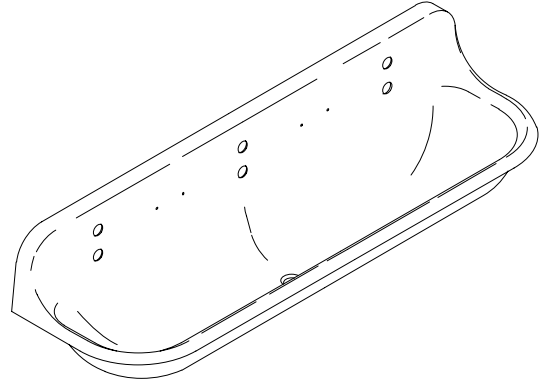

## COLORS/FINISHES

- 0 White

### Accessories:

- CP Polished Chrome
- BC Bright Chrome
- RP Rough Plate
- NA None Applicable

## SPECIFIED MODEL:

Model	Description	Colors/Finishes
K-3204	6' wash sink	<input type="checkbox"/> 0 White

Optional Accessories		
K-3264-PP	Adjustable pedestal, painted finish	<input type="checkbox"/> NA
K-3264-P	Adjustable pedestal, glazed finish	<input type="checkbox"/> NA
K-3265-PP	Adjustable pedestal, painted finish	<input type="checkbox"/> NA
K-3265-P	Adjustable pedestal, glazed finish	<input type="checkbox"/> NA
K-8820	1-1/2" sink strainer	<input type="checkbox"/> CP
K-8880	Soap dish	<input type="checkbox"/> BC
K-8892	Wash sink faucet	<input type="checkbox"/> RP

## PRODUCT SPECIFICATION:

The wash sink shall be 6' in length. Sink shall be made of cast iron with acid resistant enamel finish. Sink shall have faucet and soap dish drillings. Sink shall be Kohler Model K-3204-\_\_\_\_\_.

## PRODUCT INFORMATION

Fixture*:		basin area	water depth
Lavatory		68" x 14"	7"
Outlet	2-1/8" D.		
Faucet holes	1-1/2" D.		
Number of faucets		3	
Soap dish holes	5/16" D.		
Number of soap dishes		2	
* Approximate measurements for comparison only.			
Included Components:			
Hangers		64503	

### Roughing-In Notes

(T) Drain typically 11-7/8".

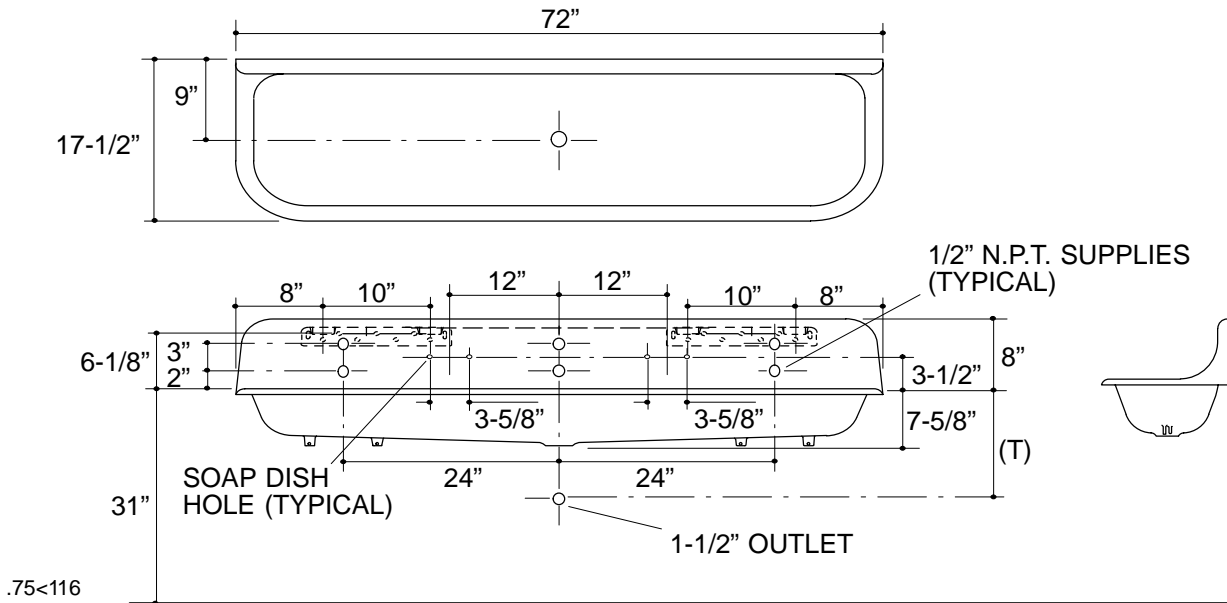

## PRODUCT DIAGRAM