

FEATURES





- Brass construction
- Modern to contemporary styling
- Completes Finial faucet line

COLORS/FINISHES

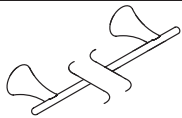

- CP Polished Chrome
- PB Polished Brass
- Other Refer to Faucets Price Book for additional finishes

SPECIFIED MODEL:





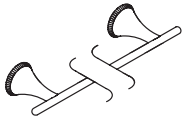

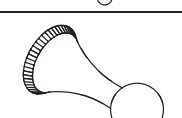
Finial Fundamentals:

Model/Description	
K-318 24" Towel Bar <input type="checkbox"/> CP <input type="checkbox"/> Other_____	
K-319 Toilet Tissue Holder <input type="checkbox"/> CP <input type="checkbox"/> Other_____	
K-322 Soap Dish Holder <input type="checkbox"/> CP <input type="checkbox"/> Other_____	
K-323 Robe Hook <input type="checkbox"/> CP <input type="checkbox"/> Other_____	

Finial Art:

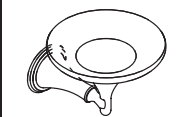
Model/Description	
K-618 24" Towel Bar; includes decorative escutcheon <input type="checkbox"/> Other_____	
K-619 Toilet Tissue Holder; includes decorative escutcheon <input type="checkbox"/> Other_____	
K-622 Soap Dish Holder; includes decorative escutcheon <input type="checkbox"/> Other_____	
K-623 Robe Hook; includes decorative escutcheon <input type="checkbox"/> Other_____	

Finial Traditional:

Model/Description	
K-360 24" Towel Bar <input type="checkbox"/> CP <input type="checkbox"/> PB <input type="checkbox"/> Other_____	
K-361 Toilet Tissue Holder <input type="checkbox"/> CP <input type="checkbox"/> PB <input type="checkbox"/> Other_____	
K-362 Soap Dish Holder <input type="checkbox"/> CP <input type="checkbox"/> PB <input type="checkbox"/> Other_____	
K-363 Towel Ring <input type="checkbox"/> CP <input type="checkbox"/> PB <input type="checkbox"/> Other_____	
K-364 Robe Hook <input type="checkbox"/> CP <input type="checkbox"/> PB <input type="checkbox"/> Other_____	
K-365 18" Glass Shelf <input type="checkbox"/> CP <input type="checkbox"/> PB <input type="checkbox"/> Other_____	

FINIAL

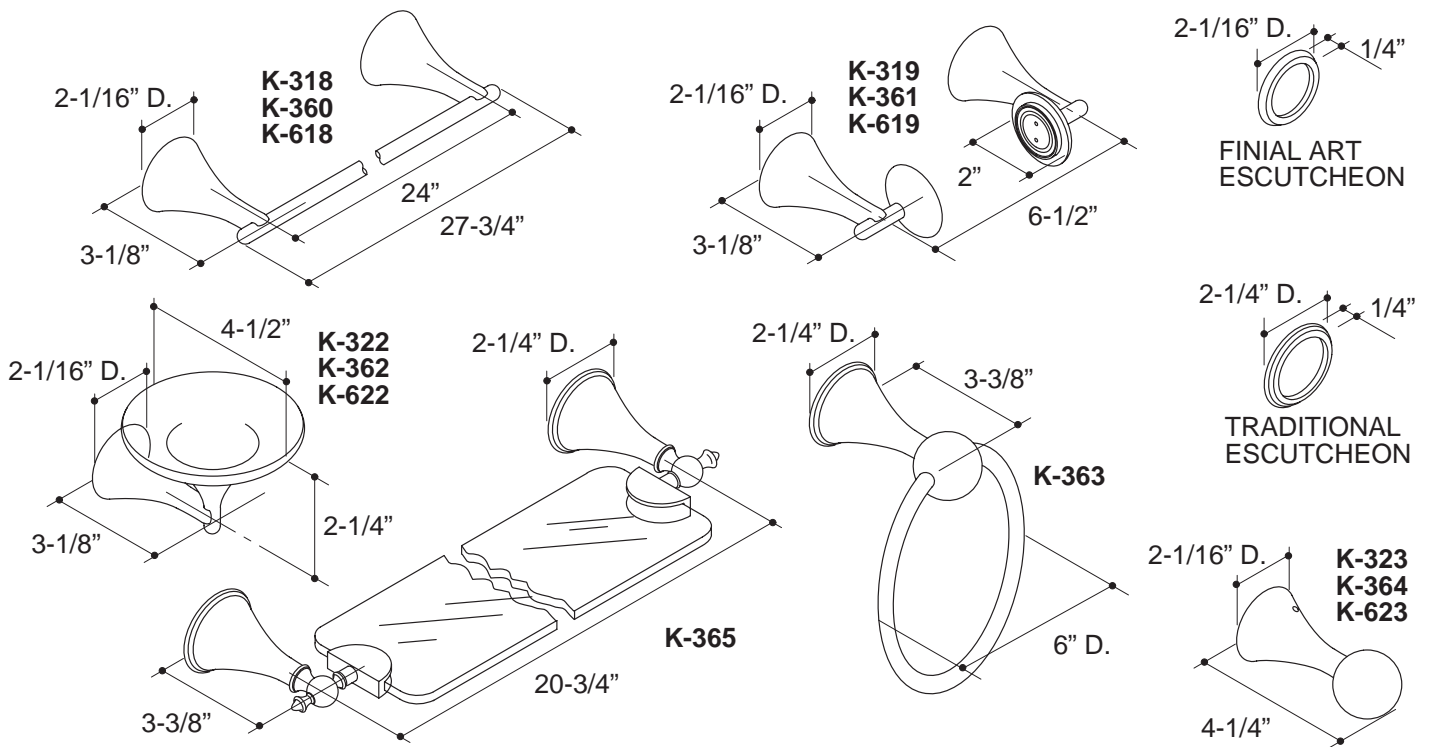

PRODUCT DIAGRAM