

FEATURES

- 72" x 36" x 20"
- Acrylic
- Left or right outlet
- System I - 3/4 hp pump with air switch actuator
- 6 factory-installed color-matched plastic Flexjets
- UL Listed
- Optional K-1283 front apron
- Optional K-1491 removable pillow
- Pump is supplied with a grounding-type plug-in cord

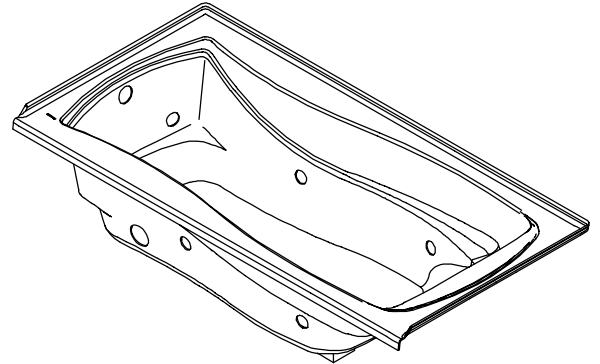

CODES/STANDARDS APPLICABLE

Specified model meets or exceeds the following:

- ANSI Z124.1
- ASME/ANSI A112.19.7M
- IAPMO/UPC
- Underwriters Laboratories (UL)
- State of Massachusetts

COLORS/FINISHES

- 0 White
- Other Refer to Fixtures Price Book for additional colors

Accessories:

- CP Polished Chrome
- PB Polished Brass
- Other Refer to Price Book for additional finishes

SPECIFIED MODEL:

Model	Description	Colors/Finishes	
K-1257-L	Whirlpool with left outlet, integral flange	<input type="checkbox"/> 0 White	<input type="checkbox"/> Other_____
K-1257-R	Whirlpool with right outlet, integral flange	<input type="checkbox"/> 0 White	<input type="checkbox"/> Other_____
K-1257	Whirlpool, drop-in rim style	<input type="checkbox"/> 0 White	<input type="checkbox"/> Other_____

Recommended Accessories			
K-7166-AF	Drain	<input type="checkbox"/> CP	<input type="checkbox"/> PB <input type="checkbox"/> Other_____

Optional Accessories			
K-1283	Apron (removable)	<input type="checkbox"/> 0 White	<input type="checkbox"/> Other_____
K-1491	Pillow	<input type="checkbox"/> 0 White	<input type="checkbox"/> Other_____
K-9696	Jet trim kit (metal finishes)	<input type="checkbox"/> CP <input type="checkbox"/> PB	<input type="checkbox"/> Other_____

PRODUCT SPECIFICATION:

The bath whirlpool shall be 72" in length, 36" in width, and 20" in height. Bath whirlpool shall be made of acrylic. Bath whirlpool shall have System I, 3/4 hp pump with air switch actuator. Bath whirlpool shall have 6 factory-installed color-matched plastic Flexjets. Bath whirlpool shall be UL Listed. Bath whirlpool shall have optional K-1283 front apron. Bath whirlpool shall have optional K-1491 removable pillow. Bath whirlpool pump shall be supplied with a grounding-type plug-in cord. Bath whirlpool shall be Kohler Model K-1257-_____-_____.

MARIPOSA™

REQUIRED ELECTRICAL SERVICE

Dedicated circuit required, protected with Class A Ground-Fault Circuit-Interrupter (GFCI):	
Pump/control	120 V., 15 A, 60 Hz

PRODUCT INFORMATION

Fixture*:	basin area	top area	weight
Bathing well	50" x 24"	65" x 27"	110 lbs.
	water depth	capacity	
To overflow	14"	72 gal.	

* Approximate measurements for comparison only.

Pump:	HP	V	Hz	A
1-speed	3/4	120	60	10.5

INSTALLATION NOTES

Each pump is supplied with a grounding-type plug-in cord. Locate the outlet behind the whirlpool, and within 24" of the pump.

The apron must be installed before the finish floor and wall materials are installed.

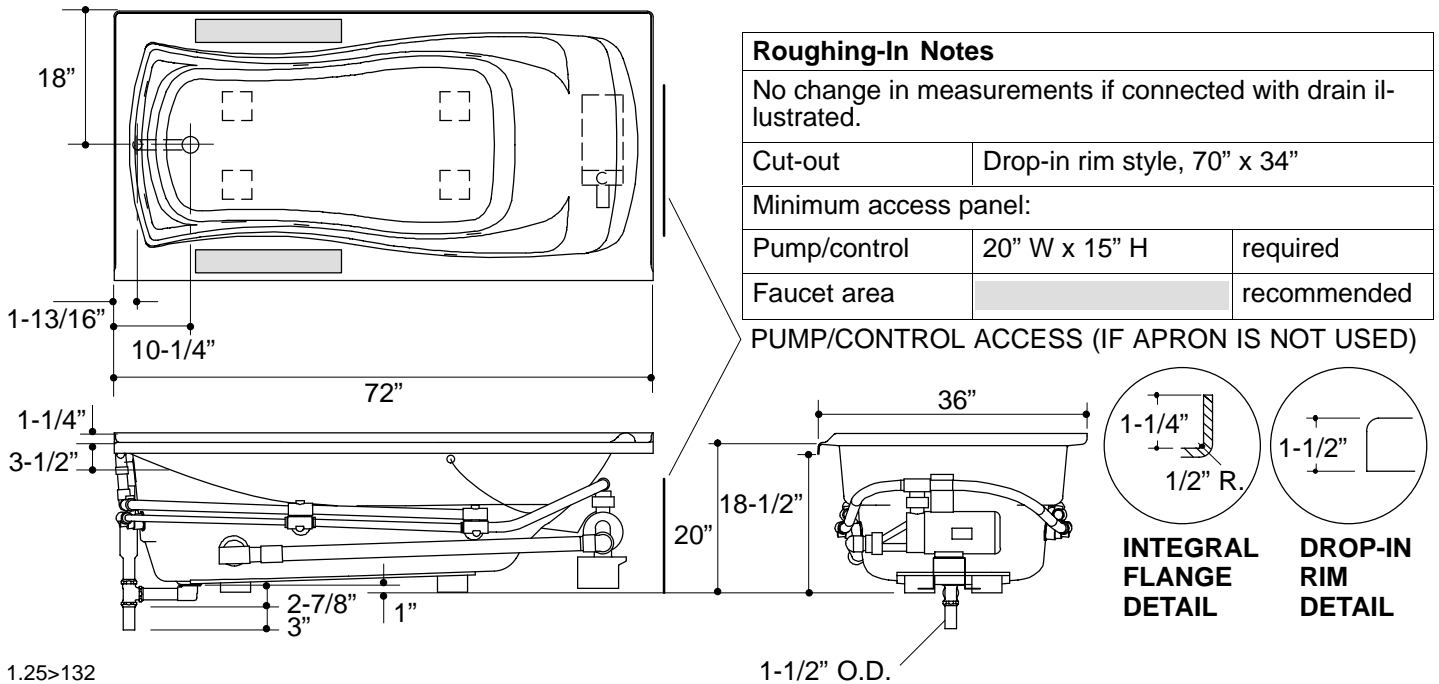

PRODUCT DIAGRAM