

Ordering Information

Applicable toilet:		
With standard tank	K-3432	shown
With insuliner	K-3432-U	not shown
With locks	K-3432-T	not shown
With cover locks and insuliner tank	K-3432-UT	not shown
Accessories/hardware:		
3/8" supply	K-7637	recommended
Floor bolts (pr.)	21401	recommended
Seat	K-4652	recommended

Product Information

Fixture:	
Configuration	2-piece, elongated
Litres per flush	6 litres
Passageway	51mm
Water depth from rim	152mm
Seat post hole centers	140mm
Included Components:	
Bowl	K-4273
Tank	K-4620
Tank cover	84635
Trip lever	K-9404

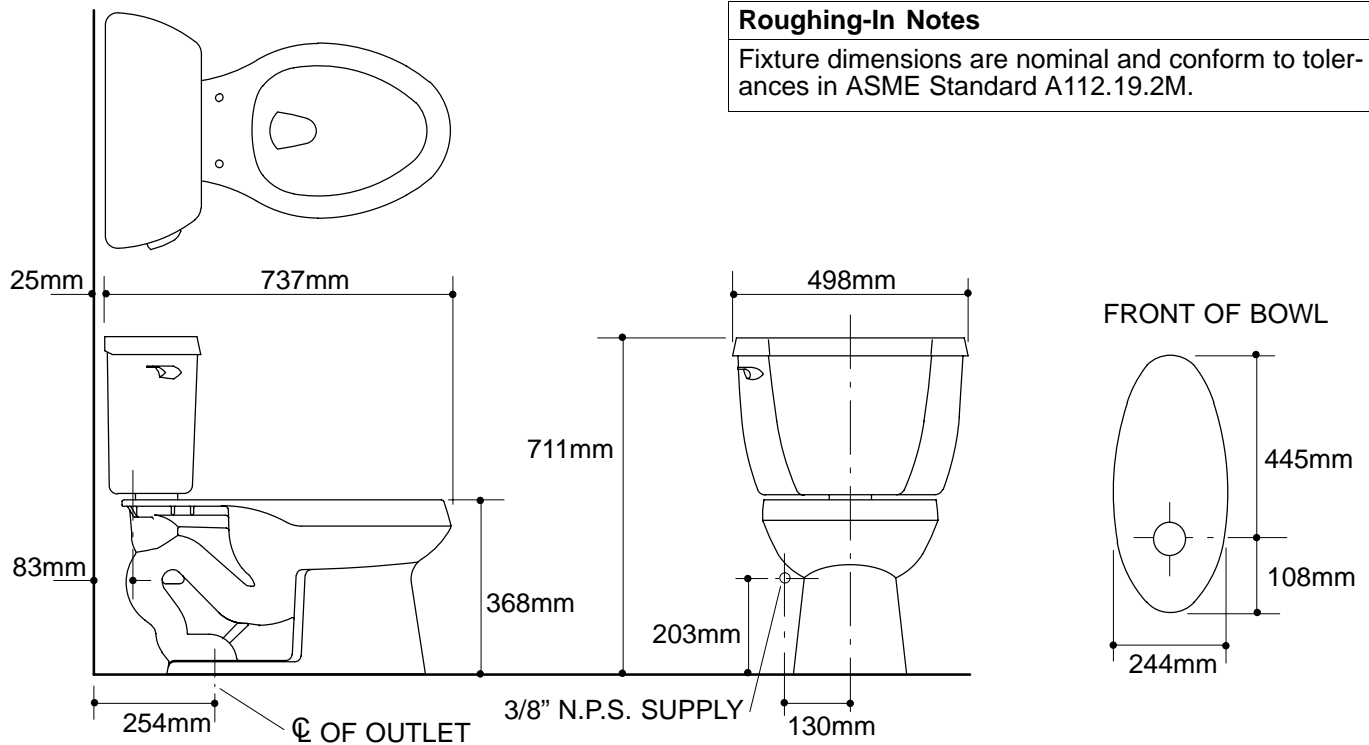

Roughing-In Notes
Fixture dimensions are nominal and conform to tolerances in ASME Standard A112.19.2M.