

FEATURES

- Brass construction
- Traditional styling
- Completes Antique faucet line

COLORS/FINISHES

- CP Polished Chrome
- PB Polished Brass
- Other Refer to Faucets Price Book for additional finishes

SPECIFIED MODEL:

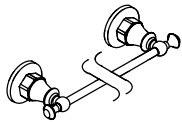
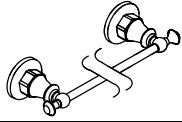
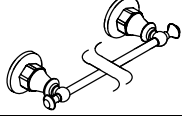
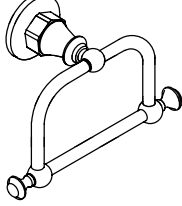
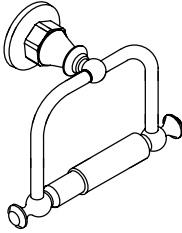
Model/Description	
K-205 Antique 18" Towel Bar <input type="checkbox"/> CP <input type="checkbox"/> PB <input type="checkbox"/> Other_____	
K-206 Antique 24" Towel Bar <input type="checkbox"/> CP <input type="checkbox"/> PB <input type="checkbox"/> Other_____	
K-207 Antique 30" Towel Bar <input type="checkbox"/> CP <input type="checkbox"/> PB <input type="checkbox"/> Other_____	
K-208 Antique Towel Ring <input type="checkbox"/> CP <input type="checkbox"/> PB <input type="checkbox"/> Other_____	
K-211 Antique Toilet Tissue Holder <input type="checkbox"/> CP <input type="checkbox"/> PB <input type="checkbox"/> Other_____	

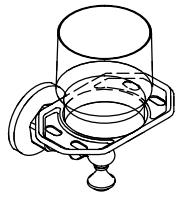
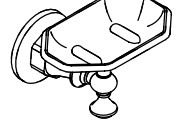
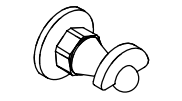
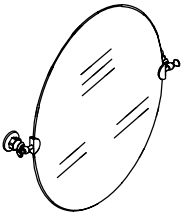
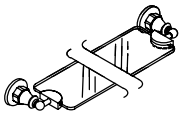
Model/Description	
K-212-GD Antique Tumbler and Toothbrush Holder; includes glass tumbler <input type="checkbox"/> CP <input type="checkbox"/> PB <input type="checkbox"/> Other_____	
K-213 Antique Soap Dish; includes removable clear acrylic soap dish <input type="checkbox"/> CP <input type="checkbox"/> PB <input type="checkbox"/> Other_____	
K-214 Antique Robe Hook <input type="checkbox"/> CP <input type="checkbox"/> PB <input type="checkbox"/> Other_____	
K-217 Antique Mirror; includes pivot mounting brackets <input type="checkbox"/> CP <input type="checkbox"/> PB <input type="checkbox"/> Other_____	
K-218 Antique Glass Shelf <input type="checkbox"/> CP <input type="checkbox"/> PB <input type="checkbox"/> Other_____	

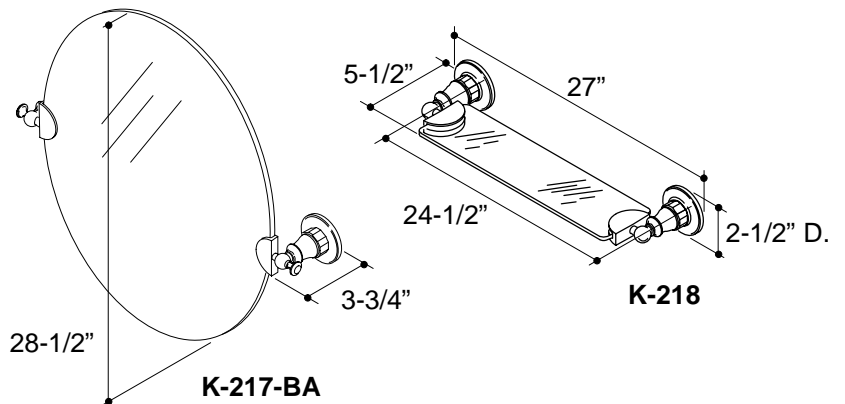
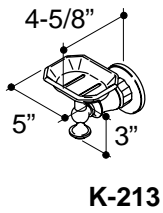
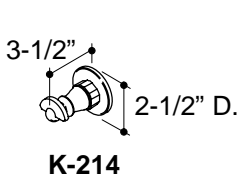
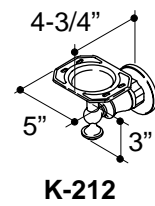
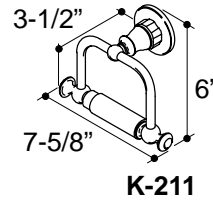
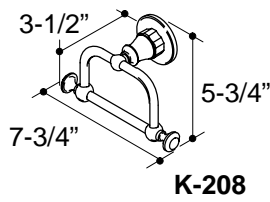
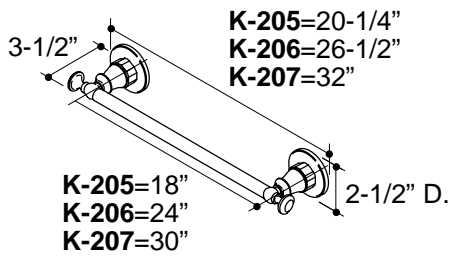

PRODUCT DIAGRAM