

FEATURES

- Brass construction
- Available with scroll or traditional handle
- Intended for use with Rite-Temp or Hi Flow Rite-Temp valves

**BATH AND SHOWER FAUCET TRIM
K-T16113**

**ALSO K-T16114, K-T16117, K-304,
K-306-KS**

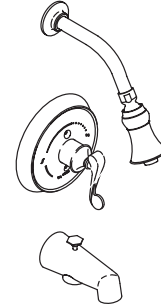

CODES/STANDARDS APPLICABLE



Specified model meets or exceeds the following:

- ASME/ANSI A112.18.1M
- CSA B125

COLORS/FINISHES

- CP Polished Chrome
- PB Polished Brass
- Other Refer to Faucets Price Book for additional finishes

SPECIFIED MODEL: For complete faucet, both faucet trim and Rite-Temp valve must be specified.

Model	Description	 ADA			 ADA		
		<input type="checkbox"/> CP	<input type="checkbox"/> PB	<input type="checkbox"/> Other_____	<input type="checkbox"/> CP	<input type="checkbox"/> PB	<input type="checkbox"/> Other_____
K-T16113-4	Bath and Shower Trim, Scroll Handle	<input type="checkbox"/> CP	<input type="checkbox"/> PB	<input type="checkbox"/> Other_____			
K-T16113-4A	Bath and Shower Trim, Traditional Handle				<input type="checkbox"/> CP	<input type="checkbox"/> PB	<input type="checkbox"/> Other_____
K-T16114-4	Shower Only Trim, Scroll Handle	<input type="checkbox"/> CP	<input type="checkbox"/> PB	<input type="checkbox"/> Other_____			
K-T16114-4A	Shower Only Trim, Traditional Handle				<input type="checkbox"/> CP	<input type="checkbox"/> PB	<input type="checkbox"/> Other_____
K-T16117-4	Valve Only Trim, Scroll Handle	<input type="checkbox"/> CP	<input type="checkbox"/> PB	<input type="checkbox"/> Other_____			
K-T16117-4A	Valve Only Trim, Traditional Handle				<input type="checkbox"/> CP	<input type="checkbox"/> PB	<input type="checkbox"/> Other_____

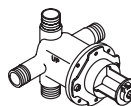
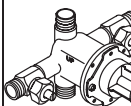
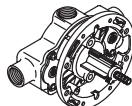
Required Accessory				
K-304-K	Rite-Temp Valve Without Stops	<input type="checkbox"/> NA		
K-304-KS	Rite-Temp Valve With Stops		<input type="checkbox"/> NA	
K-306-KS	Hi Flow Rite-Temp Valve With Integral Stops			<input type="checkbox"/> NA

Optional Accessory				
88526	Hi Flow Rite-Temp Thin Wall Installation Kit	<input type="checkbox"/> CP	<input type="checkbox"/> PB	<input type="checkbox"/> Other_____

PRODUCT SPECIFICATION:
 Rite-Temp pressure-balancing single-control bath and shower faucet trim shall be of brass construction. Bath and shower trim shall include showerhead with arm and flange, 4-7/8" diverter spout with N.P.T. connection, and faceplate with handle. Shower only trim shall include showerhead with arm and flange, and faceplate with handle. Valve only trim shall include faceplate with handle. Faucet trim shall be K-T_____-_____-_____ and Rite-Temp valve shall be K-304-_____-NA OR K-306-KS-NA Hi Flow Rite-Temp valve.

PRODUCT INFORMATION

WARNING: Risk of damage to the K-306-KS valve assembly. When using the K-306-KS valve in a fiberglass or acrylic installation, use the thin wall installation kit (88526).

INSTALLATION NOTES

Avoid cross-flow conditions. Do not install shut-off device on either valve outlet.

Cap shower outlet if deck-mount spout, diverter, or handshower is connected to spout outlet.

Install straight pipe or tube drop of 7 to 18" with single elbow between valve and wall-mount spout.

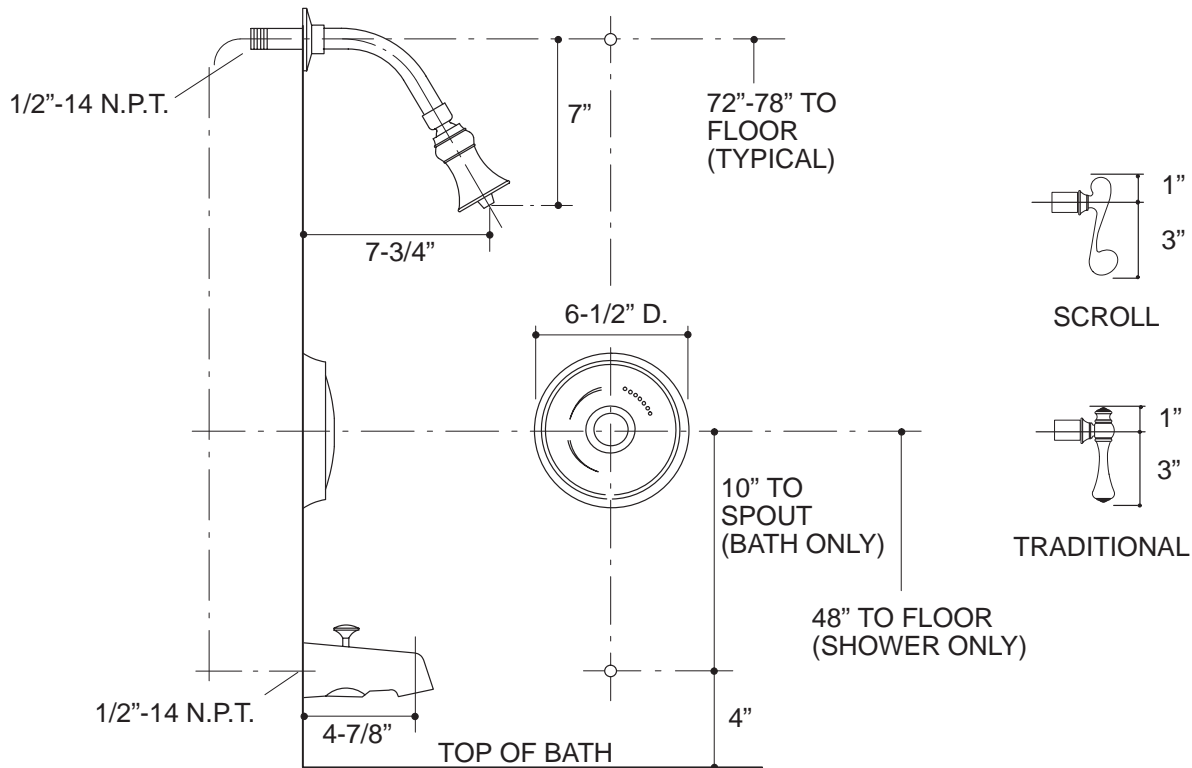

18

PRODUCT DIAGRAM