

Ordering Information

Applicable product:
 Reference models and measurements below.

Installation Notes

Refer to installation instructions included with fixture before beginning installation.

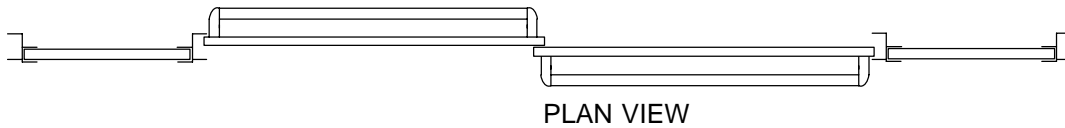
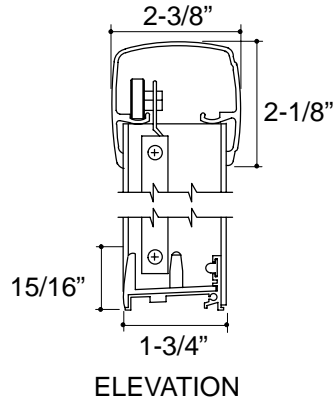

Roughing-In Notes					
	A	B	C1	C2	E
K-741100 Custom	50"-72"	39"-60"	8"-30"	8"-30"	55"-120"

