

Ordering Information

Applicable product:		
Four-hole sink	K-3346-4	shown
Three-hole sink	K-3346-3	not shown
Accessories/hardware:		
Hardwood cutting board	K-3293	optional

Product Information

Fixture*:		basin area	water depth
Sink		14" x 15"	7"
Outlet	3-5/8" D.		
Faucet holes	1-7/16" D.		
* Approximate measurements for comparison only.			
Included Components:			
Fastener kit			66407

Installation Notes

Refer to installation instructions included with fixture before beginning installation.

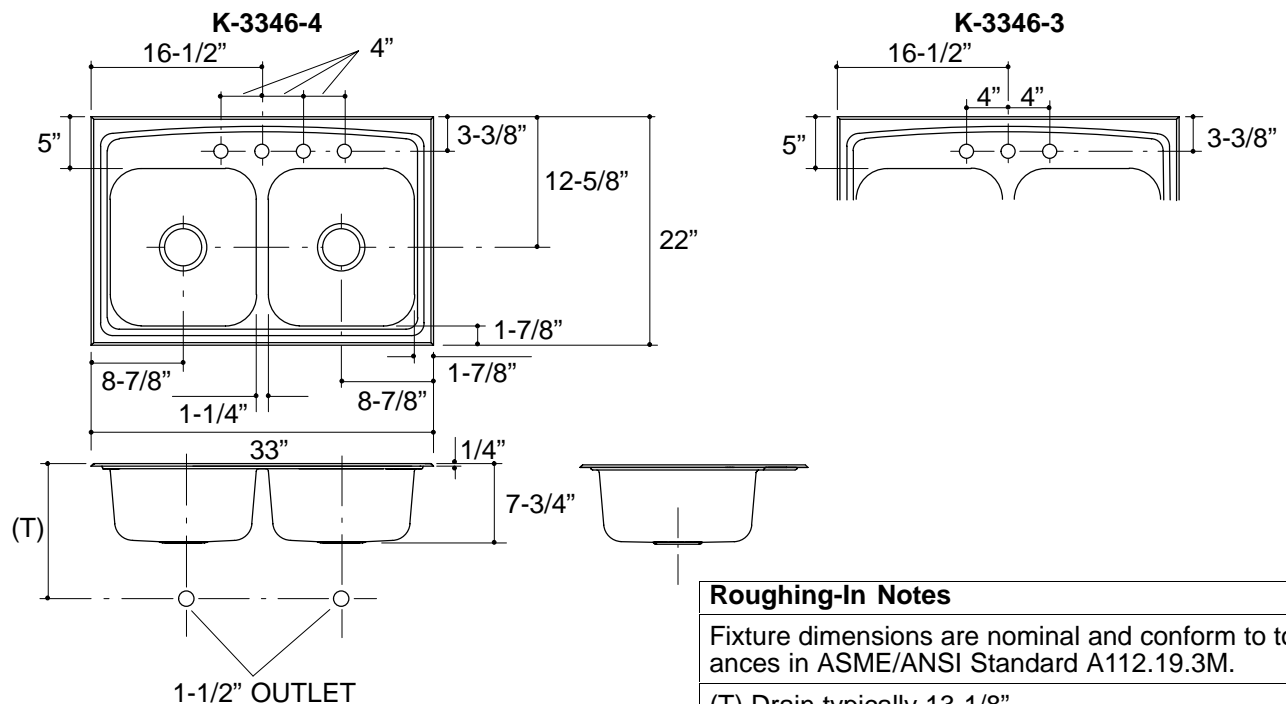

Roughing-In Notes

Fixture dimensions are nominal and conform to tolerances in ASME/ANSI Standard A112.19.3M.

(T) Drain typically 13-1/8".

Cutout 32-1/2" x 21-1/2" with 1/2" radius corners.

.85<116